

WH4002A Character 40x2

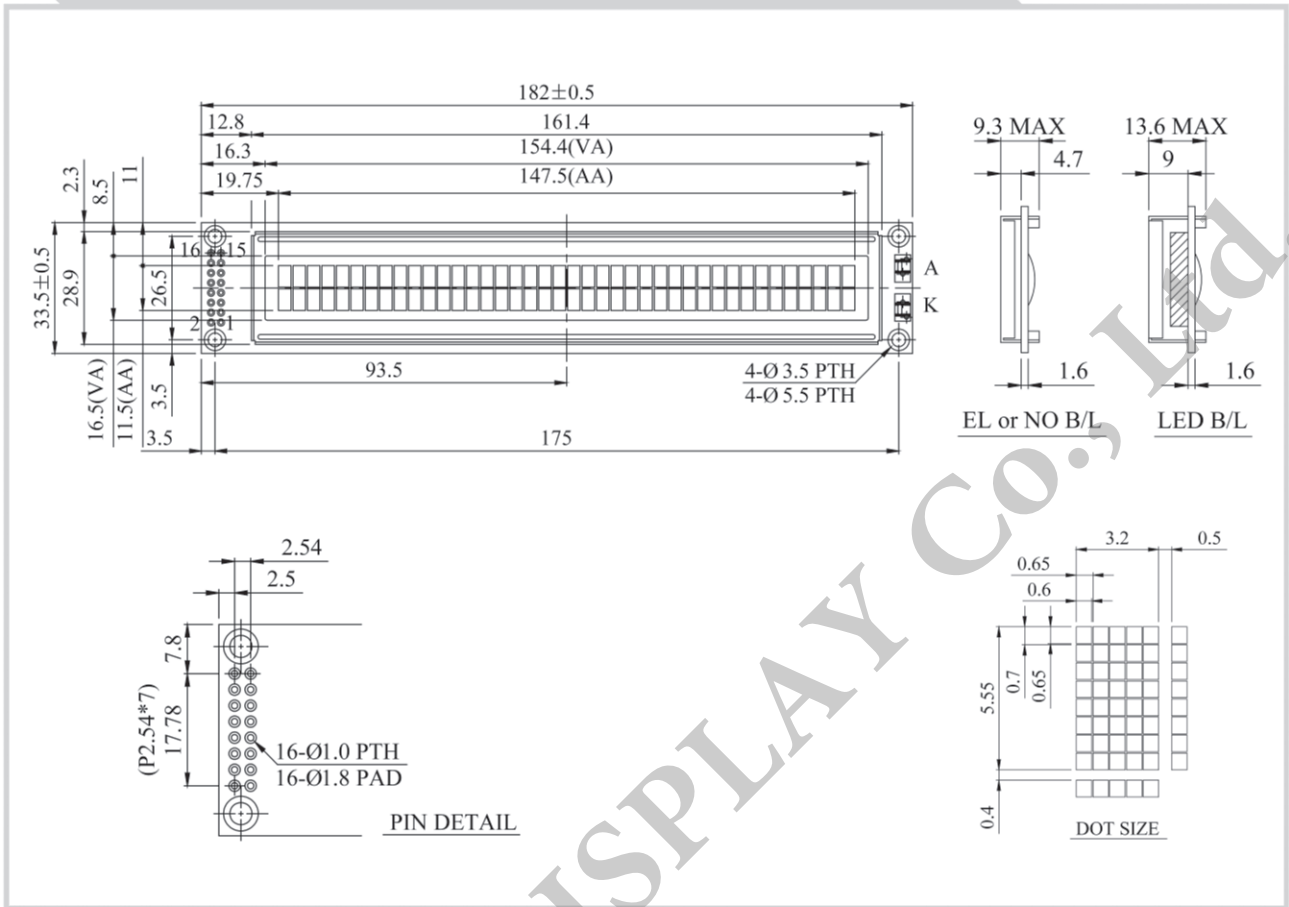

Feature

1. 16x8 dots includes cursor
2. Built-in controller (ST7066 or Equivalent)
3. 3.5V power supply (Also available for 3V)
4. N.V, optional for 3V power supply
5. 1/16 duty cycle
6. LED can be driven by PIN1, PIN2, PIN15, PIN16 or A and K
7. Interface : 6800, option SPI/I2C (RW1063 IC)

Pin No.	Symbol	Description
1	V _{SS}	Ground
2	V _{DD}	Power supply for logic
3	V _O	Contrast Adjustment
4	RS	Data/ Instruction select signal
5	R/W	Read/Write select signal
6	E	Enable signal
7	DB0	Data bus line
8	DB1	Data bus line
9	DB2	Data bus line
10	DB3	Data bus line
11	DB4	Data bus line
12	DB5	Data bus line
13	DB6	Data bus line
14	DB7	Data bus line
15	A	Power supply for B/L +
16	K	Power supply for B/L -

Mechanical Data

Item	Standard Value	Unit
Module Dimension	182.0 x 33.5	mm
Viewing Area	154.4 x 16.5	mm
Mounting Hole	175.0 x 26.5	mm
Character Size	3.2 x 5.55	mm

Electrical Characteristics

Item	Symbol	Standard Value	Unit
		typ.	
Input Voltage	VDD	3/5	V
Recommended LCD Driving Voltage for Normal Temp. Version module @25°C	VDD-VO	4.50	V

Display Character Address Code

Display position	1	2	3	4	5	6	7	8	9	...	39	40
DD RAM Address	00	01										27
DD RAM Address	40	41										67