

Panasonic

System 500 Matrix Switcher Operating Instructions

Matrix Switcher

Model No. **WJ-SX550C**
System Controller

Model No. **WV-CU550CJ**

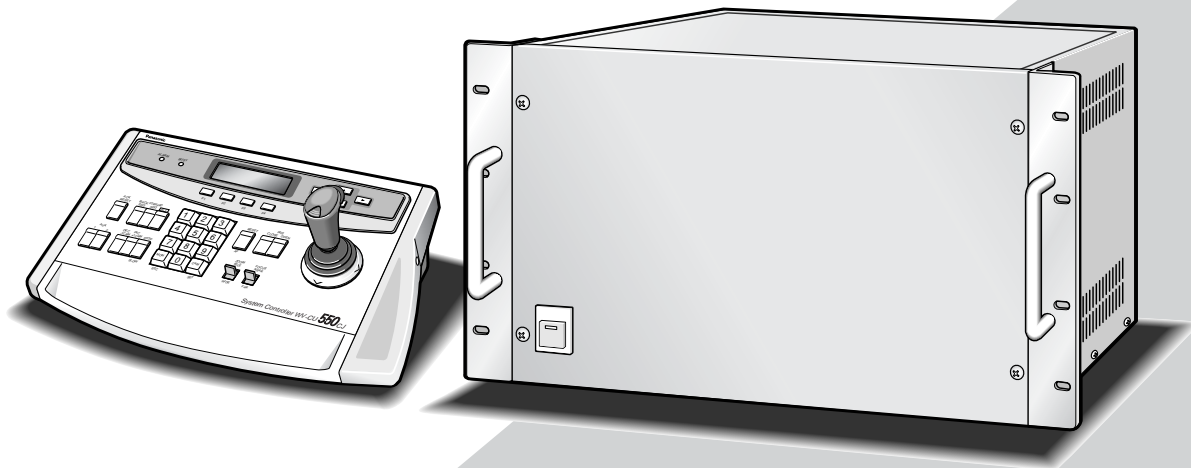

Before attempting to connect or operate this product,
please read these instructions carefully and save this manual for future use.

ENGLISH

DEUTSCH

FRANÇAIS

ENGLISH VERSION

We declare under our sole responsibility that the product to which this declaration relates is in conformity with the standards or other normative documents following the provisions of Directives EEC/73/23 and EEC/89/336.

Noi dichiariamo sotto nostra esclusiva responsabilità che il prodotto a cui si riferisce la presente dichiarazione risulta conforme ai seguenti standard o altri documenti normativi conformi alle disposizioni delle direttive CEE/73/23 e CEE/89/336.

Wij verklaren als enige aansprakelijke, dat het product waarop deze verklaring betrekking heeft, voldoet aan de volgende normen of andere normatieve documenten, overeenkomstig de bepalingen van Richtlijnen 73/23/EEC en 89/336/EEC.

Vi erklærer os eneansvarlige for, at dette produkt, som denne deklaration omhandler, er i overensstemmelse med standarder eller andre normative dokumenter i følge bestemmelserne i direktivene 73/23/EEC og 89/336/EEC.

Vi deklarerar härmed vårt fulla ansvar för att den produkt till vilken denna deklaration hänvisar är i överensstämmelse med standarddokument, eller andra normativa dokument som framställs i EEC-direktiv nr. 73/23 och 89/336.

Ilmoitamme yksinomaisella vastuullamme, että tuote, jota tämä ilmoitus koskee, noudattaa seuraavia standardeja tai muita ohjeellisia asiakirjoja, jotka noudattavat direktiivien 73/23/EEC ja 89/336/EE. säädöksiä.

Vi erklærer oss alene ansvarlige for at produktet som denne erklæringen gjelder for, er i overensstemmelse med følgende normer eller andre normgivende dokumenter som følger bestemmelsene i direktivene 73/23/EEC og 89/336/EEC.



CAUTION

RISK OF ELECTRIC SHOCK
DO NOT OPEN



CAUTION: TO REDUCE THE RISK OF ELECTRIC SHOCK,
DO NOT REMOVE COVER (OR BACK).
NO USER-SERVICEABLE PARTS INSIDE.
REFER SERVICING TO QUALIFIED SERVICE PERSONNEL.

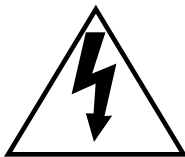

The lightning flash with arrowhead symbol, within an equilateral triangle, is intended to alert the user to the presence of uninsulated "dangerous voltage" within the product's enclosure that may be of sufficient magnitude to constitute a risk of electric shock to persons.



The exclamation point within an equilateral triangle is intended to alert the user to the presence of important operating and maintenance (servicing) instructions in the literature accompanying the appliance.

The serial number of this product may be found on the rear of the unit.

You should note the serial number of this unit in the space provided and retain this book as a permanent record of your purchase to aid identification in the event of theft.

Model No. _____

Serial No. _____



For U.K.

FOR YOUR SAFETY PLEASE READ THE FOLLOWING TEXT CAREFULLY.

This appliance is supplied with a moulded three pin mains plug for your safety and convenience.

A 13 amp fuse is fitted in this plug.

Should the fuse need to be replaced please ensure that the replacement fuse has a rating of 13 amp and that it is approved by ASTA or BSI to BS1362.

Check for the ASTA mark  or the BSI mark  on the body of the fuse.

If the plug contains a removable fuse cover you must ensure that it is refitted when the fuse is replaced.

If you lose the fuse cover the plug must not be used until a replacement cover is obtained.

A replacement fuse cover can be purchased from your local Panasonic Dealer.

IF THE FITTED MOULDED PLUG IS UNSUITABLE FOR THE SOCKET OUTLET IN YOUR HOME THEN THE FUSE SHOULD BE REMOVED AND THE PLUG CUT OFF AND DISPOSED OF SAFELY. THERE IS A DANGER OF SEVERE ELECTRICAL SHOCK IF THE CUT OFF PLUG IS INSERTED INTO ANY 13 AMP SOCKET.

If a new plug is to be fitted please observe the wiring code as shown below.

If in any doubt please consult a qualified electrician.

WARNING: This apparatus must be earthed.

IMPORTANT

The wires in this mains lead are coloured in accordance with the following code.

Green-and-yellow:	Earth
Blue:	Neutral
Brown:	Live

As the colours of the wire in the mains lead of this appliance may not correspond with the coloured markings identifying the terminals in your plug, proceed as follows.

The wire which is coloured **green-and-yellow** must be connected to the terminal in the plug which is marked with the letter **E** or by the earth symbol  or coloured **green** or **green-and-yellow**.

The wire which is coloured blue must be connected to the terminal in the plug which is marked with the letter **N** or coloured **black**.

The wire which is coloured **brown** must be connected to the terminal in the plug which is marked with the letter **L** or coloured **red**.

How to replace the fuse

Open the fuse compartment with a screwdriver and replace the fuse and fuse cover.

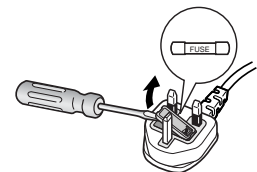

WARNING:

To reduce the risk of fire or electric shock, do not expose this appliance to rain or moisture.

TABLE OF CONTENTS

PREFACE	PAGE 4
FEATURES	PAGE 4
PRECAUTIONS	PAGE 5
HOW TO USE THIS MANUAL	PAGE 6

1 FEATURES OF THE SYSTEM 500 MATRIX SWITCHER	PAGE 7 - 18
---	-------------

2 DETAILED PRODUCT DESCRIPTION AND SELECTION	PAGE 19 - 44
---	--------------

3 INSTALLATION AND SYSTEM CONNECTIONS	PAGE 45 - 62
--	--------------

4 SOFTWARE SETUP	PAGE 63 - 92
-------------------------------	--------------

5 OPERATING PROCEDURES	PAGE 93 - 124
-------------------------------------	---------------

6 TROUBLESHOOTING	PAGE 125 - 128
--------------------------------	----------------

7 SPECIFICATIONS	PAGE 129 - 132
-------------------------------	----------------

1

2

3

4

5

6

7

PREFACE

The WJ-SX550C Matrix Switcher, when combined with the optional WV-CU550CJ System Controller and WJ-AD550 Extension Unit, allows for flexible control of 128 cameras and 16 monitors.

Tour and Group sequences for customized security requirements can be easily established through the user-friendly, on-screen menu setup.

Thanks to its modular construction, the WJ-SX550C allows for flexible expansion to meet future needs.

FEATURES

The WJ-SX550C Matrix Switcher, when combined with the WV-CU550CJ System Controller and WJ-AD550 Extension Unit, enables control of the following functions:

- Routing of up to 128 cameras to any one of 16 monitors.
- Remote control of up to 128 cameras and auxiliary equipment by using optional receivers and accessories, including:
 1. Remote control of Pan-Tilt Head and Camera Housing.
 2. Remote control of Motorized Zoom Lenses: Focus, Zoom and Iris.
 3. Remote control of camera setting, including Electronic Sensitivity Up, Electronic Shutter, Electronic Zoom, and more.

Additional features of the WJ-SX550C include:

Versatile Camera Switching Modes

- Independent programmable sequence for each monitor (16 programs)
- 32 tours including Dwell Time, Camera Preset Position and Auxiliary Controls for any monitor.
- 8 group synchronized sequences including Dwell Time, Camera Preset Positions and Auxiliary Controls
- Any tour or group synchronized sequence can be selected by operators manually. If Alarm and Time Event schedule are set up, the sequence activates automatically.

Flexible Alarm Activation

- Alarm Mode 1: Any alarm is displayed on one designated monitor, and one associated Time Lapse VTR is switched to real time mode.
- Alarm Mode 2: Any alarms are displayed on the four designated monitors, and four associated Time Lapse VTRs are switched to real time mode.
- Alarm Mode 3: Any alarms are displayed on any monitors, together with sequence routines and presets. Alternatively, any Tour or Group sequence can be assigned to any monitor or group of monitors.

Programmable System Partitioning and Priority

- Operator Registration: 5 operator access levels to system for setup and operation.
- Password protection to limit operators' access to system.
- Operator priority to lock out access by lower priority operators.

PRECAUTIONS

- **Refer all work related to the installation of this product to qualified service personnel or system installers.**
- **Do not block the ventilation opening or slots on the cover.**

To prevent the appliance from overheating, place it at least 5 cm (2 inches) away from the wall.
- **Do not drop metallic parts through slots.**

This could permanently damage the appliance. Turn the power off immediately and contact qualified service personnel for service.
- **Do not attempt to disassemble the appliance.**

To prevent electric shock, do not remove screws or covers.
There are no user-serviceable parts inside. Contact qualified service personnel for maintenance.
- **Handle the appliance with care.**

Do not strike or shake it, as this may damage the appliance.
- **Do not expose the appliance to water or moisture, nor try to operate it in wet areas.**

Take immediate action if the appliance becomes wet. Turn the power off and refer servicing to qualified service personnel. Moisture may damage the appliance and also cause electric shock.
- **Do not use strong or abrasive detergents when cleaning the appliance body.**

Use a dry cloth to clean the appliance when it is dirty. When the dirt is hard to remove, use a mild detergent and wipe gently.
- **Do not operate the appliance beyond its specified temperature, humidity or power source ratings.**

Use the appliance at temperatures within -10°C - $+50^{\circ}\text{C}$ (14°F - 122°F) and a humidity below 90 %.
The input power source for this appliance is 220 V - 240 V AC 50 Hz.

HOW TO USE THIS MANUAL

The purpose of this manual is to provide step-by-step instructions for setting up and operating a Matrix System 500. If a Matrix Switcher is new to you, it is highly recommended that you read through this manual. If you are already familiar with the Matrix Switcher, you may skip Sections 1 and 2 and start from Section 3, Installations and System Connections. The contents of each section of this manual are summarized below.

Section 1. Features of the System 500 Matrix Switcher

Describes the main features of the System 500.
Numerous illustrations provide easy-to-understand explanations.

Section 2. Detailed Product Description and Selection

Operating controls and their functions are explained in this section.
Also, in-depth information about each board is given here, along with details about proper board setup.
A table is included here that specifies how many optional boards are required for every possible system expansion.

Section 3. Installation and System Connections

Information about cable connections between the Matrix Switcher and System Controllers, cameras, monitors and peripheral devices is provided here.

Section 4. Software Setup

Step-by-step procedures for successful initial programming of the system are explained in this section.
Graphical representations of the various setup tables are also provided.
This section is very important as proper programming of the system is vital for customizing the system to the end user's requirements.

Section 5. Operating Procedures

After system programming, normal operation of the system on a daily basis is done by following the steps outlined in this section.

Section 6. Troubleshooting

Most of the problems in a Matrix System can be traced to faulty hardware or software setup.
This section is invaluable as an aid in identifying the sources of common problems. Reading this section before requesting service will save you time in resolving those problems.

Section 7. Specifications

SECTION 1

FEATURES OF THE SYSTEM 500 MATRIX SWITCHER

SYSTEM DIAGRAM

Shown below is an example of the expansion capabilities of the WJ-SX550C Matrix Switcher.

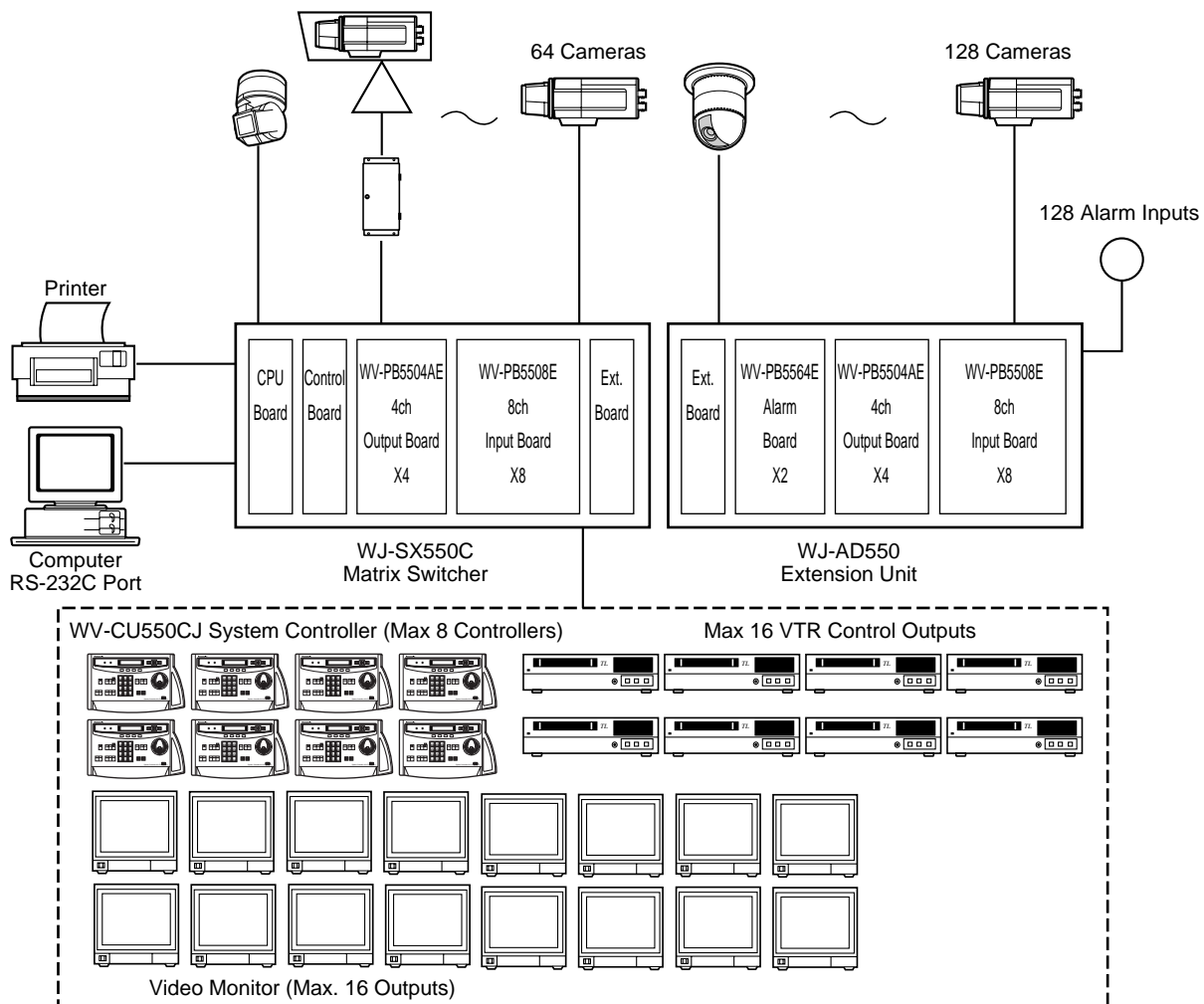

Camera Input: Up to 128 cameras can be connected. The pan/tilt head, zoom /focus/iris of the lens and auxiliary switching can be controlled via a single coaxial cable through a receiver. Also, preset control of the lens and pan/tilt head position is possible by using the Combination Camera System.

Monitor Output: Up to 16 monitors can be connected. The camera title, camera and monitor number and alarm condition can be displayed on the monitor screen.

System Controller: Up to 8 controllers may be connected. A variety of controls are accessible through the LCD display on the system controller. The System Controller also provides access to the Set Up Menu and Tables for programming.

VTR: Up to 16 VTRs can be connected. The video signal controlled by the WJ-SX550C Matrix Switcher is supplied to the VTR. Also, the Matrix Switcher can supply the VTRs with an alarm output signal to switch time lapse recording mode.

Alarm Input: Up to 128 alarm signals can be supplied. An Alarm Sensor with a Normally Open or Normally Closed circuit should be used.

Printer Output: The data programmed on the Setup Menu can be printed out.

RS-232C Port: The system controller can be substituted by connecting a Personal Computer to control the system.

Note: For using a Personal Computer, you will need special software offered separately.

FEATURES

1

Log-in

To operate the Matrix Switcher System 500, a registered operator must first supply his/her Operator Number and Password to the system.

The operator number and password are established by using the REGISTRATION table. See page 14 for more details on operator number registration.

If an attempt is made to enter an operator number and password that do not match with the registered operator numbers and passwords, entry into this system is denied.

As shown in the examples below, there are 2 additional attributes associated with an operator: operator level and priority. These items are described in more detail on page 14.



Operator name: Mike
Operator number: 1
Operator level: 1
Password: 07171
Priority: 1



Operator name: Robert
Operator number: 15
Operator level: 13
Password: 11524
Priority: 8

Notes:

- Factory Default Setting Operator number: 1
Password: 12345
are registered to allow access for first time system programming.
- An operator can be logged-in to this system from several system controllers.
- If the main power of the Matrix Switcher is turned off, log-in procedures must be performed again.
- If power to the system controller is turned off, the system controller will record operating status when power is resupplied.

Camera and Monitor Selection

After logging in, the desired camera and monitor combination can be selected.

Basically, any combination of camera and monitor, which are connected to the Switcher, can be selected as shown below.

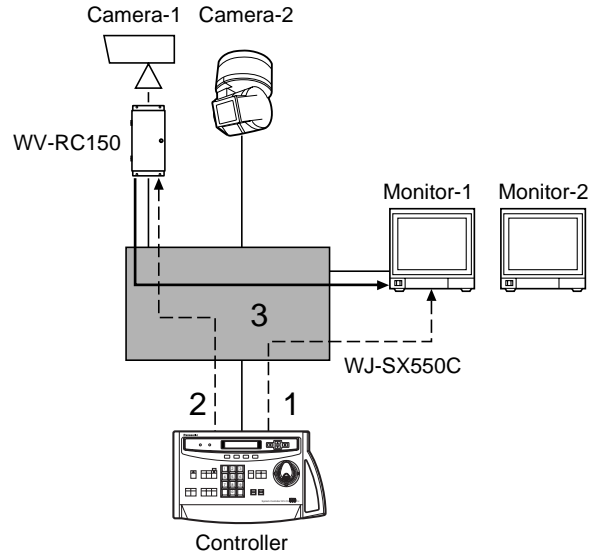

General Procedures

1. Select the desired monitor. (Monitor and controller are linked.)
2. Select the desired camera. (Camera and controller are linked.)
3. The picture of the selected camera view is displayed on the selected monitor.

Monitor Selection

By selecting the monitor with the System Controller, it is linked with the System Controller.

At this time, the camera output signal that was last supplied to the monitor is displayed.

Press the Numeric keys (1 to 16), then press the **MON (ESC)** key to select the desired monitor.

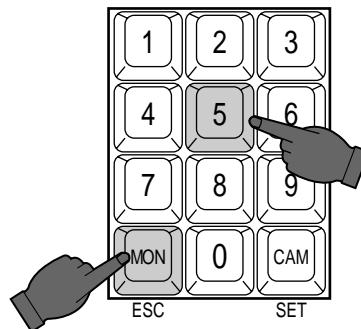

For example: When selecting monitor Number 5:
Press 5, then press the **MON (ESC)** key.

Notes: The desired monitor selection may not be available due to one of the following reasons:

- The System Controller used for selecting a particular monitor is not allowed access to that monitor because of controller partitioning. See page 16 for more details.

- The desired monitor is currently selected by another operator who has a higher operator priority, and therefore, control over that monitor.

In this case, "Monitor Busy" or "NOT AVAILABLE" will be displayed on the LCD Display of the System Controller.

● Camera Selection

The video signal from the desired camera can be supplied to the selected monitor.

Press the Numeric keys (1 to 128), then press the **CAM (SET)** key to select the desired camera.

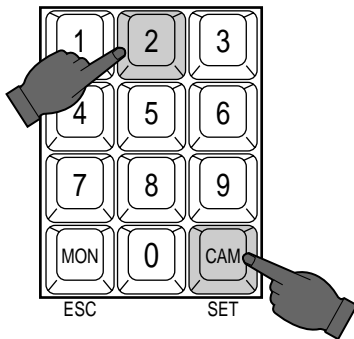

For example: When selecting Camera Number 2:
Press 2, then press the **CAM (SET)** key.

Notes: The desired camera selection may not be available due to one of the following reasons:

- The operator is not allowed access to the desired camera because the Operator Registration has limited the operator's access to certain cameras. See page 14 for more details.

- The desired camera is currently selected by another operator who has a higher operator priority, and therefore, control over that camera.

In this case, "Camera Busy" will be displayed on the LCD Display of the System Controller.

■ Camera Site Control

The selected camera (if applicable) can be controlled by the System Controller.

Specified Panasonic combination cameras can have various functions controlled remotely without the need for a receiver.

Note: Because future camera models may have additional features and functions, please refer to the Operating Instructions provided with the camera for more details.

● Lens Focus Control

This control is used to adjust the lens focus to obtain a sharply focused picture while observing the monitor screen.

● Lens Zoom Control

This control is used to adjust the lens zoom to obtain the desired picture while observing the monitor screen.

● Lens Iris Control

This control is used to close or open the lens iris to obtain the proper picture exposure while observing the monitor screen.

● Pan/Tilt Control

This control is used to pan or tilt the pan/tilt head.

The following operations are available.

- Manual Operation
Using the Joystick Controller to move the Pan/Tilt head towards the desired direction.
Eight directions are available: UP/DOWN/RIGHT/ LEFT/ UP-RIGHT/UP-LEFT/DOWN-RIGHT/DOWN-LEFT.
- Auto Panning Operation
It is necessary to use a Pan/Tilt head such as the WV-7225 or specified Panasonic combination camera equipped with the auto pan feature in a system.
- Random Panning Operation
It is also necessary to use a Pan/Tilt head equipped with the random panning feature, such as the WV-7225, in a system.

● Preset Control

The preset function is used to memorize the focus, zoom, pan and tilt setting values of any scene to have them available for easy recall at any time.

In addition, if the Camera Position Number is saved with its associated camera number and preset position, the camera position can be recalled quickly by activating the camera selection and preset function at the same time.

This control is available when the specified camera equipped with the preset feature is used in a system.

● Auxiliary (AUX) Control

This control is used to turn on or off the user's auxiliary switches located in the Receiver, such as the WV-RC100, WV-RC150 or WV-RC170 Receivers.

■ Sequence

This system has three kinds of sequential modes: Program, Tour and Group

● Program Sequence

The Program Sequence is a series of 64 steps assigned to a particular monitor.

Each step has a Camera and Dwell Time assigned to it.

In the Program Sequence, each monitor has its own specified sequence operation as shown below.

• Auto Skip Function

The Auto Skip function is available in sequence mode. If there is no video signal present at a step, the sequence will automatically skip that step.

This function is enabled from the Set Up Menu.

• Dwell Time

The amount of time each camera view is displayed on the monitor (Dwell Time) can be set from 1 second to 30 seconds in 1-second increments.

This function is set from the Set Up Menu.

External Timing, which is controlled from the Time Lapse VTR, can also be selected from the Set Up Menu.

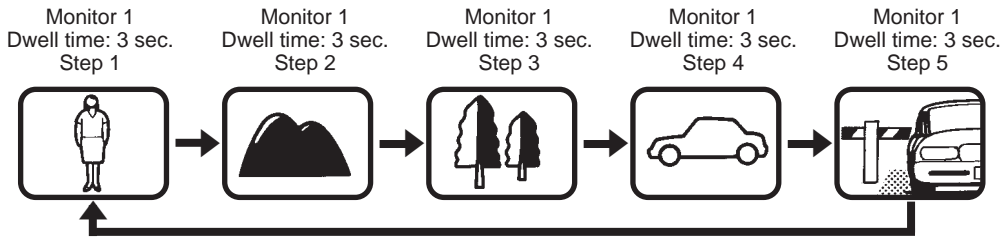

● Tour Sequence

A Tour Sequence consists of 64 steps.

Each step has a Camera, Dwell Time, Auxiliary Control and Pan/Tilt Preset assigned to it.

A total of 32 Tour Sequences can be programmed on the Set Up Menu.

A Tour can be assigned to any monitor.

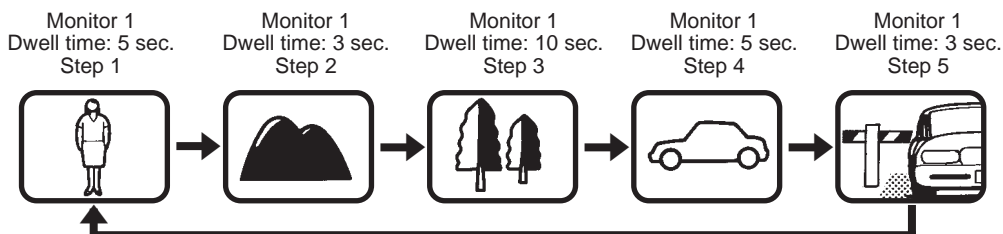
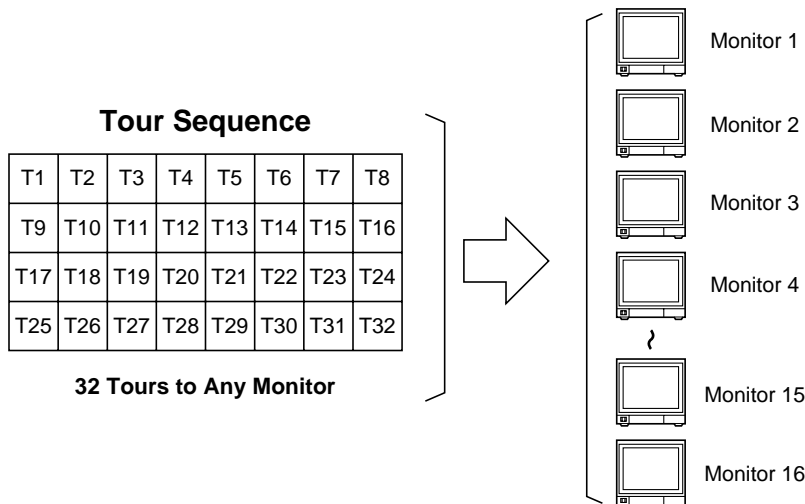

● Group Sequence

A Group Sequence consists of up to 64 steps.

In each step, a maximum of 16 cameras can be assigned to 16 monitors.

Pan/Tilt preset and Auxiliary control (1 & 2) can also be set for each camera/monitor combination.

Camera view switching (Dwell Time) for each step can be set from 1 second to 30 seconds in 1-second increments.

There are 8 Group Sequences available, with programming performed on the Set Up Menu.

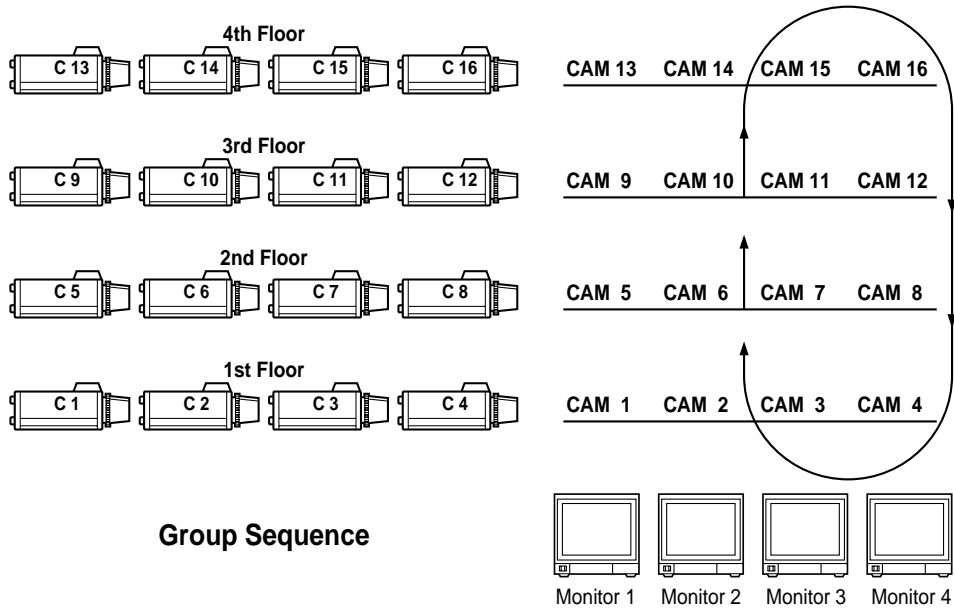

■ Timer Event

The timer function is used to program and automatically activate Tour or Group Sequences according to the time of day, day of week and 5 user defined special days.

There are 45 timer events available in one day.

■ Alarm Control

● Alarm Input

There are 2 kinds of alarm inputs available in the system.

• Camera Site Alarm

This alarm signal is supplied from the associated camera site receiver or camera.

Receivers capable of camera site alarm input are models WV-RC100, WV-RC150 and WV-RC170.

• Interface Alarm

This alarm signal is supplied from the Alarm Input (ALARM IN) Connector on the optional Alarm Boards installed in the WJ-SX550C Matrix Switcher.

Up to 128 alarm inputs are available.

• Alarm Operation Modes

There are three alarm operation modes available in the WJ-SX550C Matrix Switcher.

The alarm modes can be switched according to the time programmed on an internal timer.

Examples of these modes are described below.

Alarm Mode 1: Any alarmed pictures are assigned to Monitor 1.

Mode 1 displays all alarms on Monitor 1.

If more than one alarm is activated, the system will sequentially display the alarms on Monitor 1.

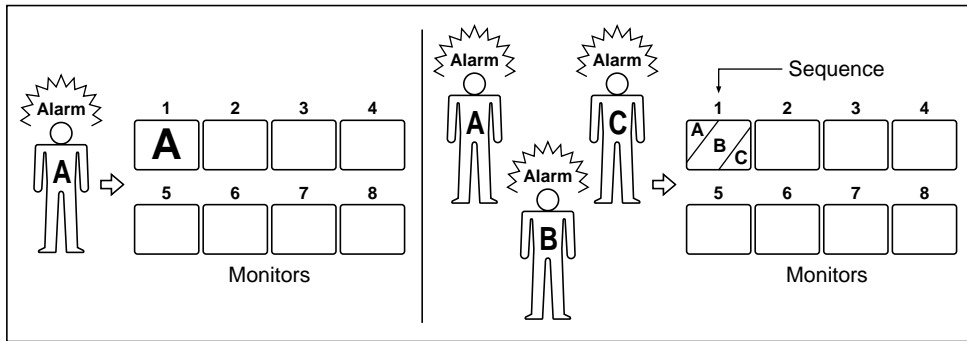

Alarm Mode 2: Any alarmed pictures are assigned to four Monitors (1 - 4).

Mode 2 displays the first alarm on Monitor 1.

When the second alarm is received, the first alarm is shifted to Monitor 2 and the second alarm is displayed on Monitor 1 and so on.

This means, the latest alarm is always displayed on Monitor 1.

If more than four alarms are activated, the system will sequence the pictures starting with Monitor 1, then 2, etc.

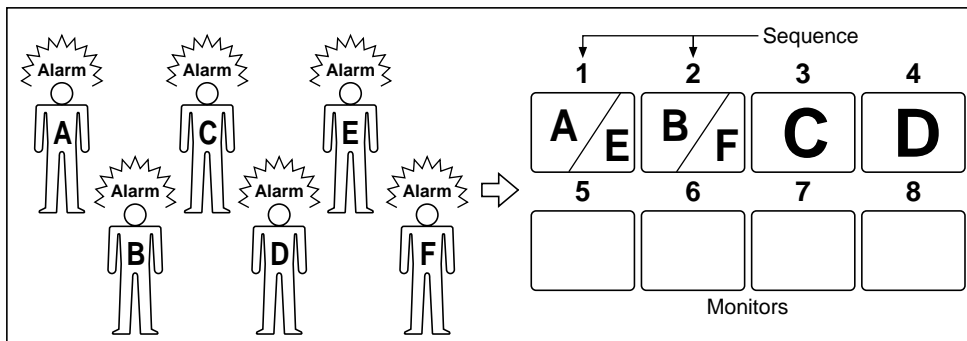

Alarm Mode 3: Any alarmed pictures are assigned to any monitors.

Mode 3 is a fully programmable mode. Any alarm can be shown on any monitor, plus sequence routines, presets and auxiliary relays in receivers can be activated.

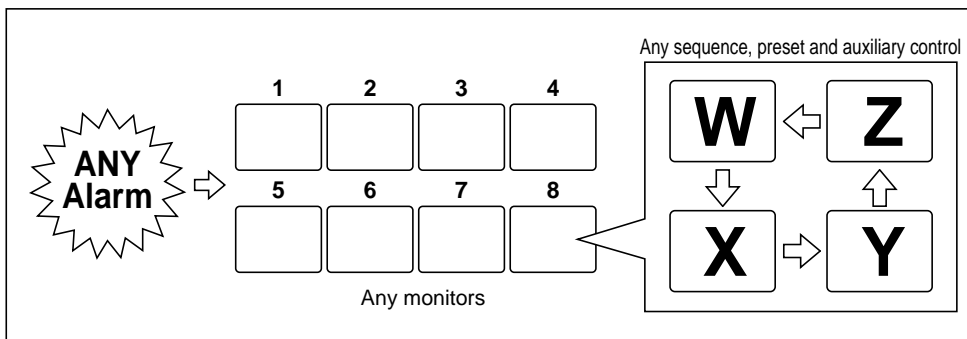

● **Alarm Recall**

The WJ-SX550C Matrix Switcher can store up to 99 Alarm Logs in its memory.

The alarms may be recalled and displayed in chronological order on any desired monitor.

Operator Registration

On the Operator Registration tables, an operator's level, priority, password and camera access limits can be programmed. Up to 30 operators may be registered.

For example:

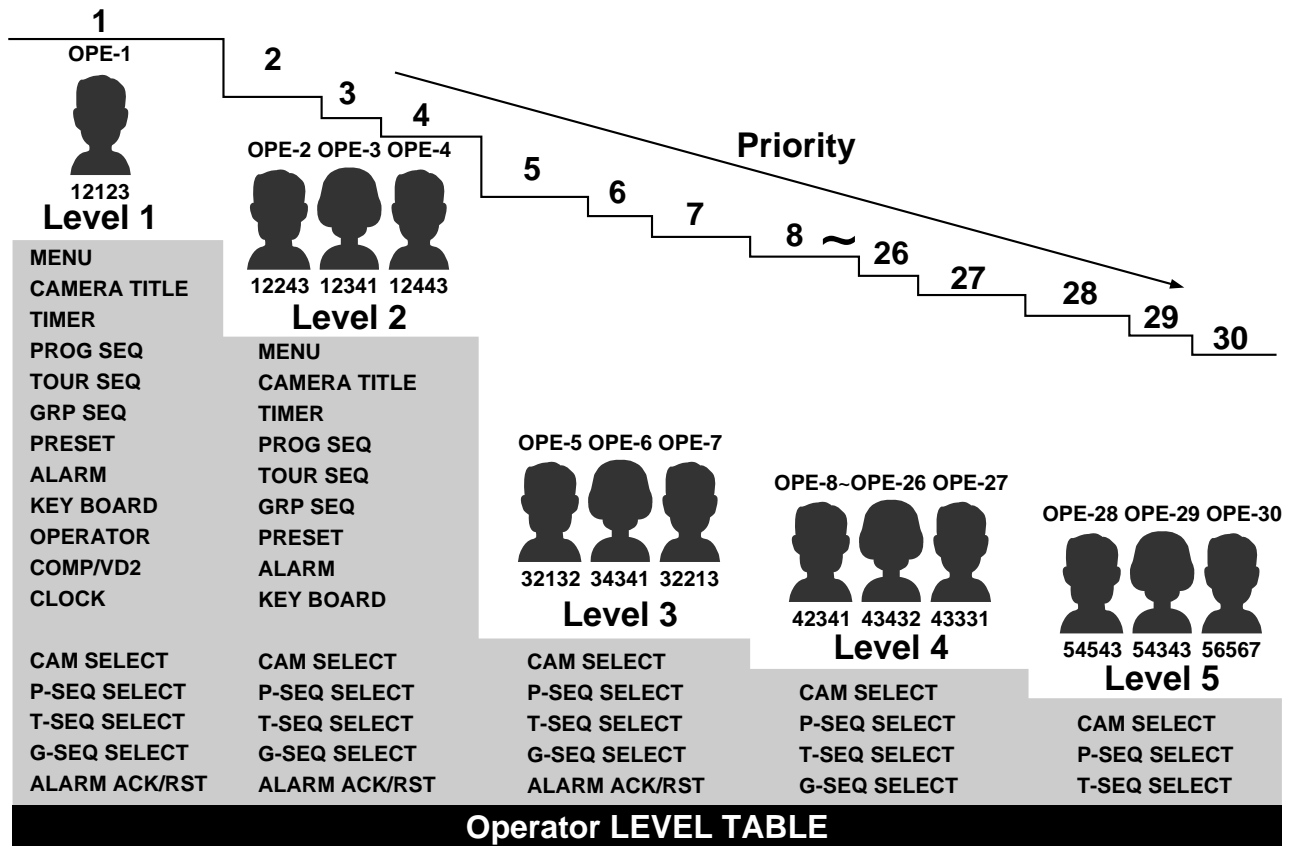

● Level Setting

Operator access to various setup functions and system operations is determined by the operator's level. There are five separate levels available (Level 1 is the highest).

● Priority

When two or more operators attempt to perform the same function at the same time, the operator with the higher priority is allowed to perform the function while the lower priority operators' attempts are denied. There are 30 priority levels available in this system.

● Password

All operators have a five digit long password assigned to them.

● Operator Limits for Camera Access

Access to any camera's video and control of the camera's pan/tilt head may be restricted to certain operators.

■ Camera Title and On-screen Display

A camera title for each camera input is available for display on the monitor screen. Each title is composed of 15 characters per line, times 2 lines.

All items listed below, except Alarm On/Off and Timer mode, can be included or excluded from display on the selected monitor screen.

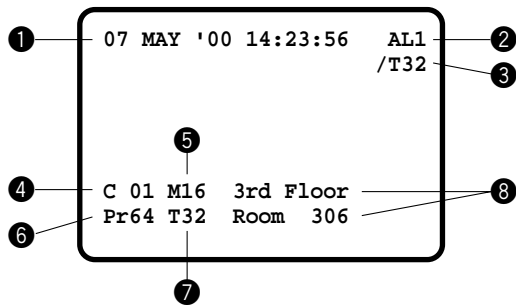

- ① Date and Time
- ② Alarm On/Off
AL0: Camera Site Alarm
AL1: Interface Alarm
- ③ Timer Mode
- ④ Camera Number
- ⑤ Monitor Number
- ⑥ Preset Position Number
- ⑦ Sequence Mode in Effect
- ⑧ Camera Title

Note: When the overscanning mode is selected on a monitor, the screen display (edge portion) may be partially hidden.

■ System Status Display

This table shows the system status in real time. Possible Active modes, as indicated in this table, are defined below.

AL	Monitor	Camera	Mode	CTRLR	Operator	Priority
●	01	11	T 01 F	1	01	05
●	02	21	SPOT			00
	03	09	T 08 F			
	04	48	G 2 S			
	05	63	G 2 S			
	06	17	G 2 S			
	07	10	CAM	2	11	01
	08	03	SPOT	8	02	03
	09	35	T 64 F			
	10 in	09	SPOT	4	26	10
	11	49	T 11 F			03
	12	53	G 1 B			02
	13	49	G 1 B			02
	14	26	G 1 B			02
	15	30	SPOT			
	16	51	SPOT			

- SPOT : Spot
- P : Program Sequence
- T : Tour Sequence
- G : Group Sequence
- CAM : Camera Setting
- SET : Setup
- in : Displays video connected to the Video Output Board
- F : Forward Sequence
- B : Backward Sequence
- S : Paused

System Controller-Monitor Partitioning

This feature is used to prevent specific WV-CU550CJ System Controllers from controlling the outputs of specific monitors. It prevents an operator from unintentionally gaining control over a monitor that may not be associated with his/her station.

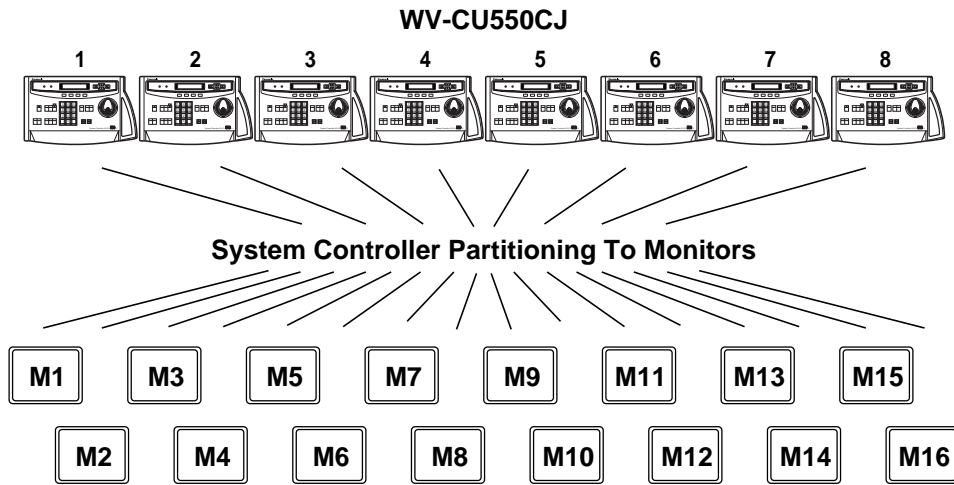

For example:

The following example demonstrates the use of both system controller-monitor partitioning and operator priority.

- Camera: 8 sets
- Monitor: 3 sets
- System Controller: 3 sets
- Operator : 3 persons

Setting Procedure

1. Operator Number 1 has the first priority . Cameras 1-8 can be selected by Monitor 1.
2. Operator Number 2 has the second priority. Cameras 1-5 can be selected by Monitor 2 (limited access due to operator partitioning).
3. Operator Number 3 also has the second priority. Cameras 4-8 can be selected by Monitor 3.

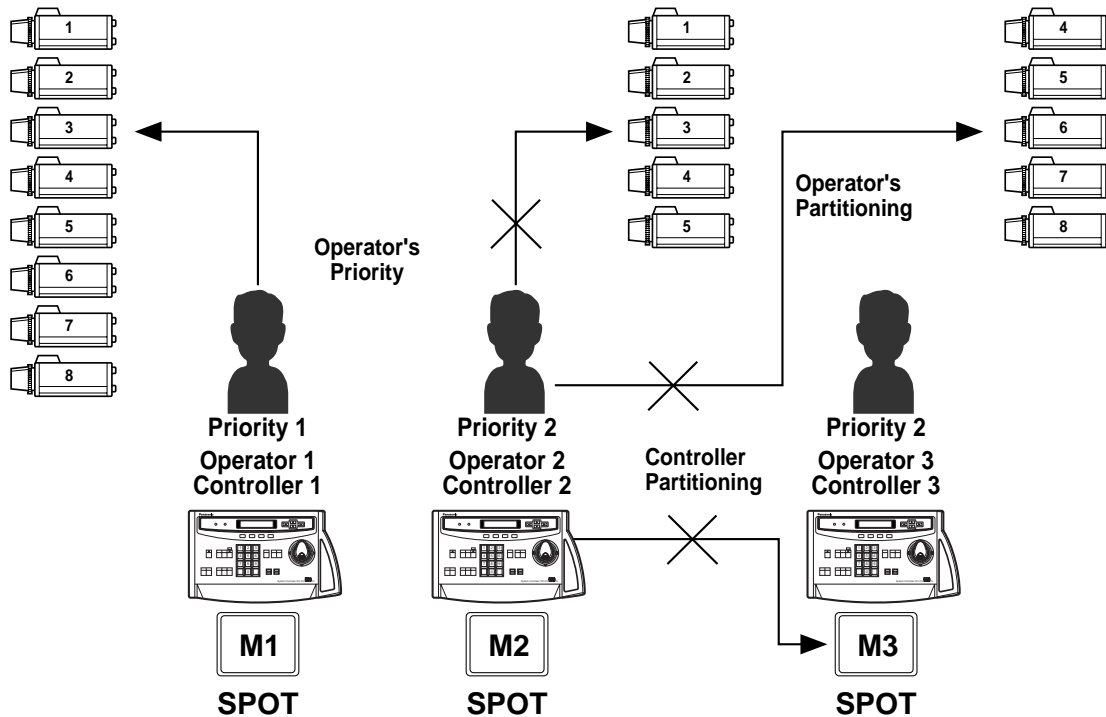

1. In the above system, when Operators 1 and 2 both select camera 3 simultaneously, the selection of Operator 1 is allowed because Operator 1 has a higher priority.
2. Operator 2 can not select camera 6 because operator's partitioning limits access to cameras 1-5 by Operator 2.
3. Operator 2 can not control Monitor 3 because controller partitioning prevents access to monitor 3 by Operator 2.

■ Synchronizing the Sequence with External Timing

The camera switching interval (Sequence Dwell Time) can be synchronized with the time lapse mode set in the associated Time Lapse VTR.

Select the On or Off mode on the EXT Timing Select table to meet each monitor's requirements.

Caution: Set the interval time for the external timing signal of the external equipment to 1 second or more. If the interval is set to less than 1 second, the system will not work properly.

■ Cable Compensation/VD2

Cable Compensation

This feature is used to compensate for signal loss due to cable length.

The most suitable position for cable-loss compensation can be selected in the Set Up Menu.

Available cable length compensations are shown below.

- S: Up to 500 m (1 600 ft)
- M: 500 m (1 600 ft) to 900 m (2 900 ft)
- L: 900 m (2 900 ft) to 1 200 m (4 000 ft)
(When using RG-6/U or equivalent)

VD2 (Vertical Drive Sync Signal)

The VD2 (Vertical Drive Sync Signal) can be turned On or Off by using the Set Up Menu.

Select VD2 On or Off to meet camera requirements.

■ RS-485 Site Communication

The parameters for communication with the Camera Site can be set on the RS-485 Site Communication table in the Set Up Menu, if the optional WV-PB5548E Data Board is installed in the Matrix Switcher.

(The WV-RM70 Camera Controller or a modem may be required in the system.)

Note: Be sure to select the correct Baud rate when using a modem.

■ Clock

On-screen clock display is available.

The date and time can be set on the Clock Set table.

■ Printer

A parallel printer can be used to print out the Status, Alarm Recall or Setup data.

The recommended printer to use is the Panasonic KX-P1624 Impact Dot Matrix Printer.

■ RS-232C Port

This port is used for connecting with a Personal Computer. The memory of the WJ-SX550C Matrix Switcher can be loaded or saved.

A Personal Computer can be substituted for the WV-CU550CJ System Controller to control the system.

Note: For using a Personal Computer, you will need special software offered separately.

SECTION 2
DETAILED
PRODUCT DESCRIPTION
AND SELECTION

MAJOR OPERATING CONTROLS AND THEIR FUNCTIONS

WJ-SX550C Matrix Switcher

■ Appearance

● Front View

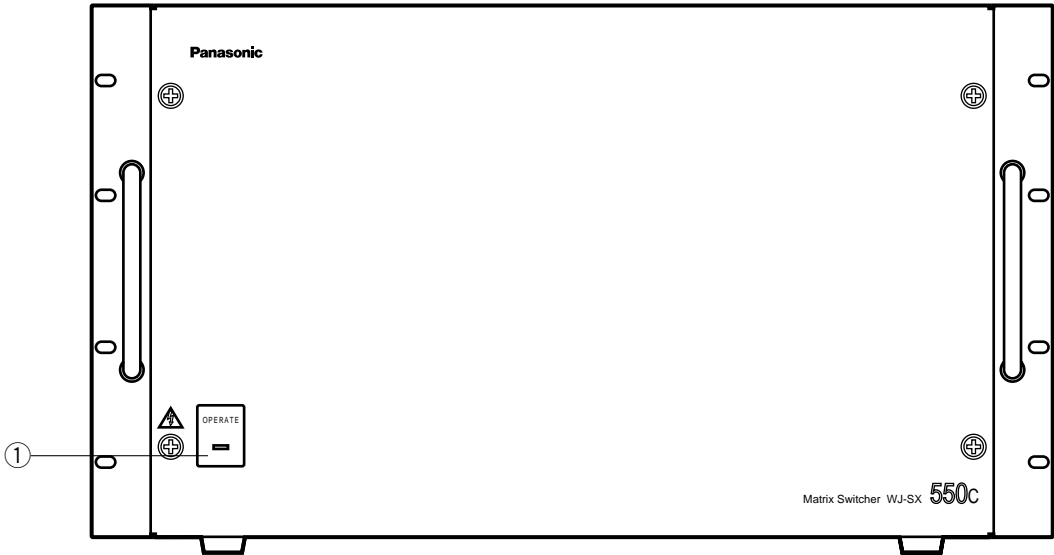

● Rear View

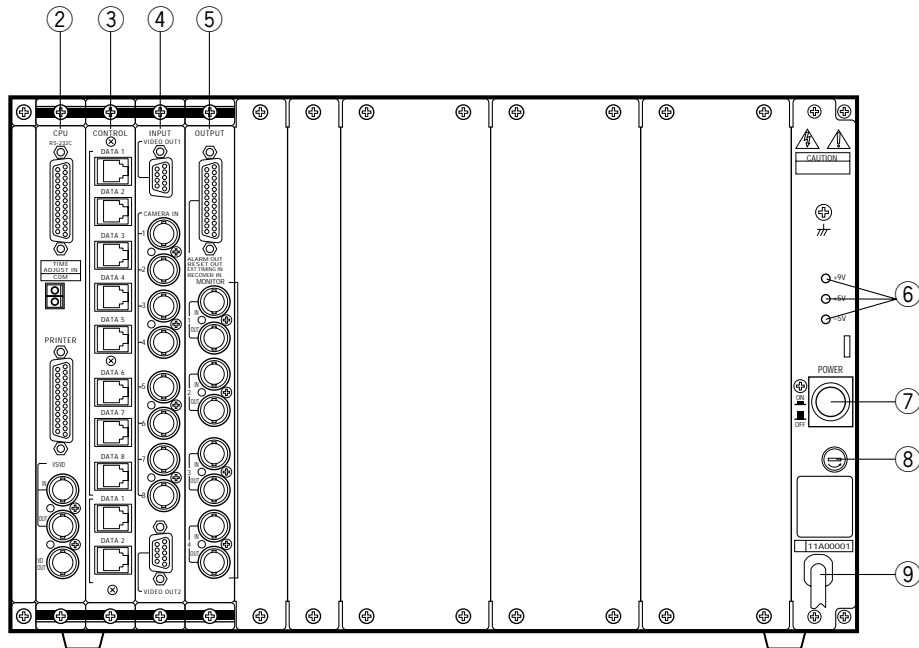

① **Operate Indicator (OPERATE)**

Is on when the power of the WJ-SX550C Matrix Switcher is turned on.

② **CPU Board (CPU)**

A personal computer and printer can be connected to this board.

Refer to the CPU Board on page 22 for more details.

③ **Control Board (CONTROL)**

The system controllers can be connected to this board.

Refer to the Control Board on page 25 for more details.

④ **Video Input Board (INPUT)**

The cameras and receivers are connected to this board.

Refer to the Video Input Board on page 27 for more details.

⑤ **Video Output Board (OUTPUT)**

The video monitors can be connected to this board.

Refer to the Video Output Board on page 29 for more details.

⑥ **Voltage Indicator (+9V, +5V, -5V)**

These LEDs indicate the presence of +9 V, +5 V and -5 V regulated DC voltages.

⑦ **Power Switch (POWER ON/OFF)**

This switch is used to turn the Matrix Switcher power on and off.

⑧ **Fuse Holder**

⑨ **AC Power Cord**

■ CPU Board

● Appearance

① RS-232C Port (RS-232C)

This port is used to connect a personal computer that can store or load the memory in the WJ-SX550C Matrix Switcher. This port also enables control of the Matrix Switcher with a personal computer substituted for the WV-CU550CJ System Controller (by using optional software).

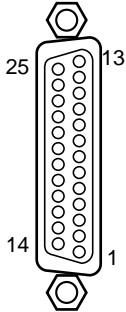

Pin No.	Designation	Direction
1	(FG)	
2	SD	PC → Switcher
3	RD	PC ← Switcher
4	RS	PC → Switcher
5	CS	PC ← Switcher
6	DR	PC ← Switcher
7	SG	
8	CD	PC ← Switcher
20	ER	PC → Switcher
Other pins are not used.		

② Time Adjustment Input Connector (TIME ADJUST IN)

Accepts the time adjustment signal from a Time Lapse VTR. It enables the time display of the WJ-SX550C Matrix Switcher and the Time Lapse VTR to be matched.

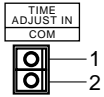

Pin No.	Designation
1	Signal
2	Ground

③ Printer Port (PRINTER)

This port is used to connect a parallel printer which can provide a print out of the System Status, Alarm Recall or Setup operation data.

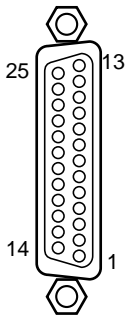

Pin No.	Designation	Direction
1	/STROBE	Printer ← Switcher
2	DATA 0	Printer ← Switcher
3	DATA 1	Printer ← Switcher
4	DATA 2	Printer ← Switcher
5	DATA 3	Printer ← Switcher
6	DATA 4	Printer ← Switcher
7	DATA 5	Printer ← Switcher
8	DATA 6	Printer ← Switcher
9	DATA 7	Printer ← Switcher
10	/ACK	Printer → Switcher
11	BUSY	Printer → Switcher
12	(R)	Monitor ← Switcher
13	(G)	Monitor ← Switcher
14	(B)	Monitor ← Switcher
15	(SYNC)	Monitor ← Switcher
16	/PRIM	Printer ← Switcher
17	Not used	
18	Not used	
19	Ground	
20	Ground	
21	Ground	
22	Ground	
23	Ground	
24	Ground	
25	Ground	

Note: If a printer is not used in the system, pins 12-15 may be used for displaying the system status on the monitor screen (RGB type input).

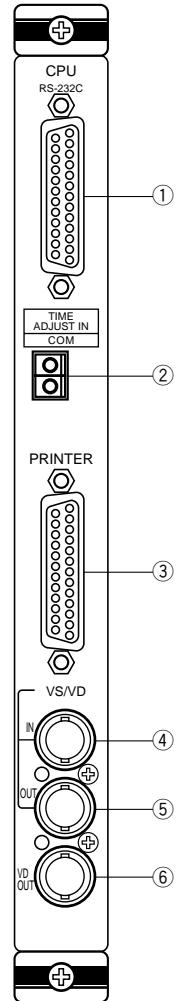

④ VS/VD Input Connector (VS/VD IN)

Accepts either the VD (Vertical Drive) pulse or the VS (Video Sync) signal for synchronizing the system.

Notes:

- This input is looped through to the VS/VD Output Connector.
- When the VD (or VS) signal is supplied to the VS/VD Input Connector, turn the VD/VS selection switch (SW4) on the circuit board to the VD (or VS) position. The factory default setting of the VD/VS selection switch (SW4) is VS. Ask qualified service personnel about setting up this switch.
- The external sync signal should meet CCIR specifications and should not contain any jitters, such as a VTR playback signal.

⑤ VS/VD Output Connector (VS/VD OUT)

Outputs either the VD (Vertical Drive) pulse or the VS (Video Sync) signal for synchronizing other system components.

Note: The input at the VS/VD Input connector is looped through to this output. These inputs and outputs are connected internally.

⑥ VD Output Connector (VD OUT)

Outputs VD (Vertical Drive) pulses for synchronizing other system components.

Notes:

- The internal VD pulse or the loop-through external VD pulse is provided at this connector.
- When the VS signal is supplied to the VS/VD Input Connector, the VD output signal from the VD Output Connector will be delayed by approximately 15 μ sec with respect to the V-sync of the VS input signal.

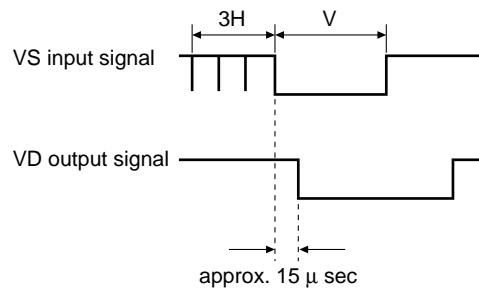

By changing the position of jumper connector (CN14) on the board, this connector can be used for displaying the system status on the monitor screen. (Set Up Menu is displayed during setup mode.)

Caution

This board should be installed in the WJ-SX550C Matrix Switcher even if the WJ-AD550 Extension Unit is used.

● Board Setting

Before installing this board, the following settings should be made by qualified service personnel or system installers.

2

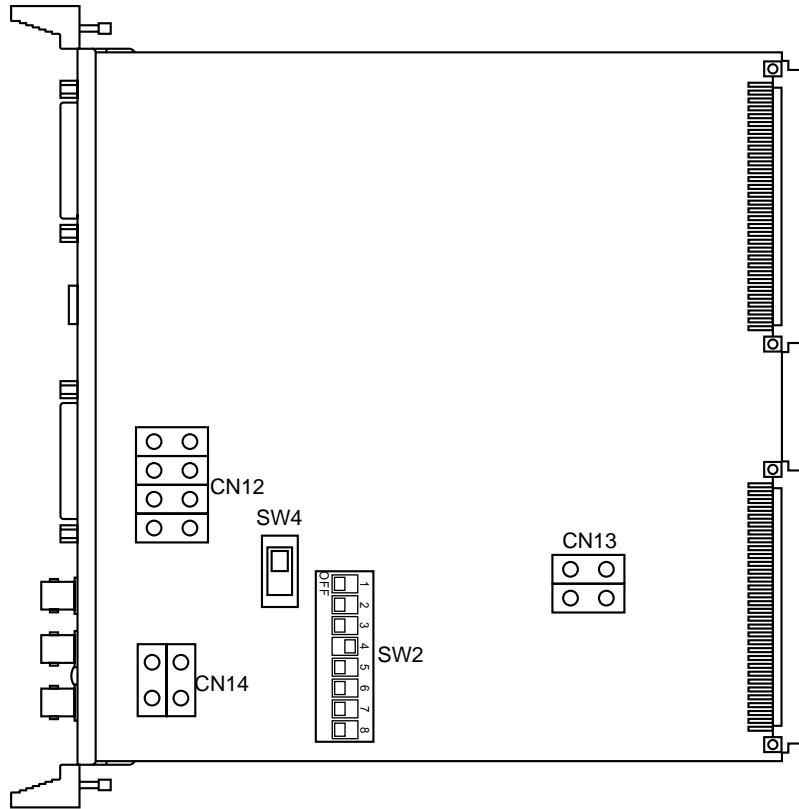

1. Confirm that Switches (SW2) on the board are set as follows.

Note: These switches are used only for factory test. Always keep these switches in the positions below in the field.

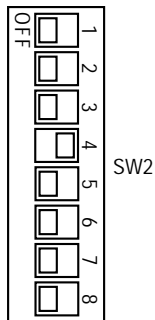

2. Set switch (SW4) on the board to select either VD or VS for the Sync input signal, if applicable. The factory default setting is VS.

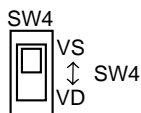

3. Position jumper connectors (CN12) on the board to open connection position when a printer is connected to the board.

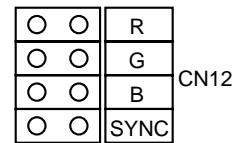

4. Position jumper connector (CN13) on the board to the "C/L" position when the setup menu tables are not clearly displayed on the colour monitor. The factory default setting is "B/W".

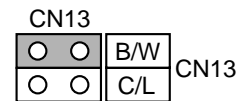

5. Position jumper connector (CN14) on the board to select either VD Output or Status Display Output for the VD Output Connector. The factory default setting is VD.

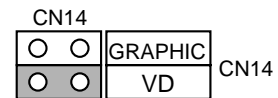

■ Control Board

● Appearance

① Data Ports (DATA 1 - 8)

For exchanging control data with the WV-CU550CJ System Controller. Eight ports are available on the board. Connect supplied 6-conductor modular cable or use a data grade shielded 4-wire twisted pair cable suitable for RS-485 communication. Cable length may be extended up to 1 200 m (4 000 ft).

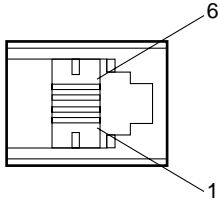

Pin No.	Designation	Direction
1	Ground	
2	RB	Switcher ← Controller
3	RA	Switcher ← Controller
4	TB	Switcher → Controller
5	TA	Switcher → Controller
6	Ground	

② Test Ports (TEST 1, 2)

These ports are used only for factory test.

Caution

This board should be installed in the WJ-SX550C Matrix Switcher even if the WJ-AD550 Extension Unit is used.

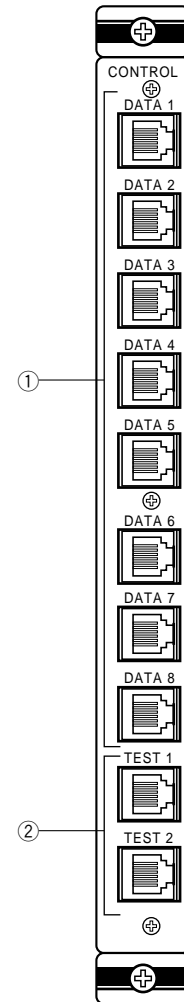

● Board Setting

Before installing this board, the following settings should be made by qualified service personnel or system installers.

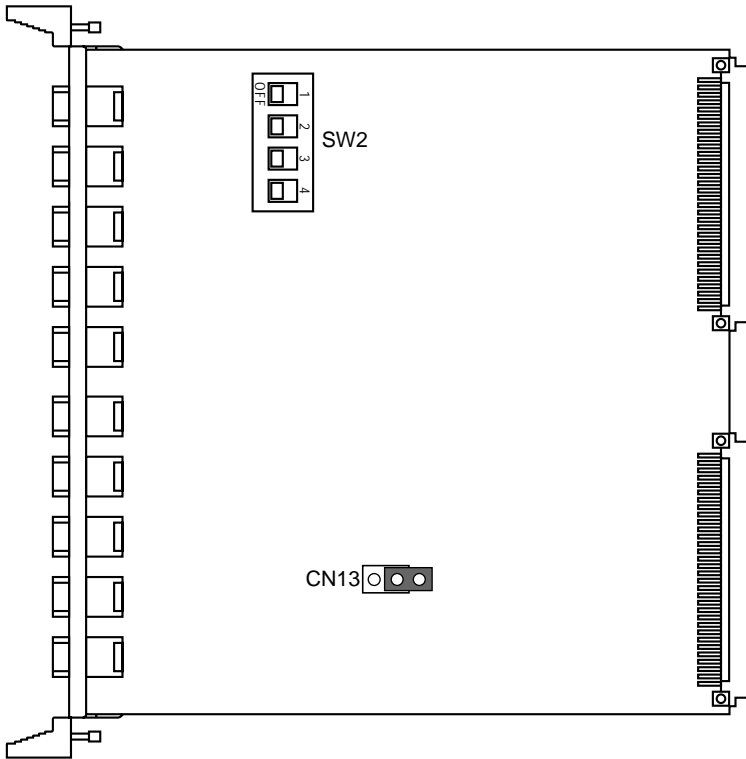

2

1. Confirm that switches (SW2) on the board are set as follows.

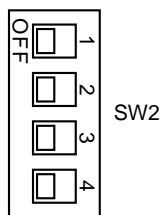

Note: These switches are used only for factory test.
Always keep these switches in the “OFF” positions in the field.

2. Position jumper connector (CN13) on the board as shown below.

Open: When the controllers are connected in a “Home Run” connection.
Closed: When the controllers are connected in a “Daisy-Chain” connection.

The factory default setting is Open.

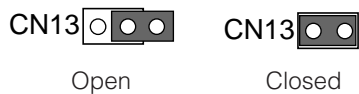

■ WV-PB5508E Video Input Board

● Appearance

① Video Output Ports (VIDEO OUT 1, 2)

The video signal connected to the Camera Input Connector (CAMERA IN) is present at these ports.

The camera control data multiplexed on the video signal is not available at these ports. When the power of the Matrix Switcher is turned off, no signal is present at these ports.

BNC female connectors are available for conversion by use of optional WV-CA64 loop through cable.

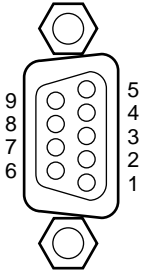

Pin No.	VIDEO OUT 1	VIDEO OUT 2
1	Not used	Not used
2	CH1	CH5
3	Ground (CH1)	Ground (CH5)
4	CH2	CH6
5	Ground (CH2)	Ground (CH6)
6	CH3	CH7
7	Ground (CH3)	Ground (CH7)
8	CH4	CH8
9	Ground (CH4)	Ground (CH8)

② Camera Input Connector (CAMERA IN, 1 - 8)

These connectors accept either a colour or B/W composite video signal from a camera.

In addition, the VD2 signal for synchronizing the vertical timing of the cameras, and data to control camera site devices are multiplexed through this connector.

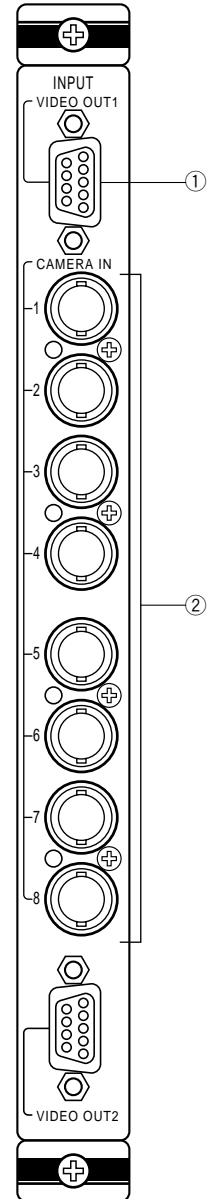

● Board Setting

Before installing this board, the following setting should be made by qualified service personnel or system installers.

Set switches (SW1) on the board to designate the camera input board number as shown in the following table. The factory default setting is Board Number 1.

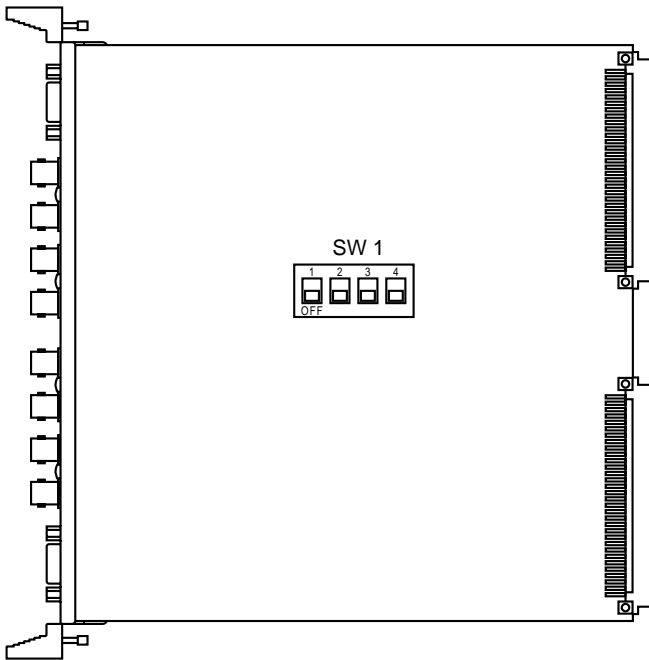

Cautions

- Board Numbers 9 to 16 are only used when the WJ-AD550 Extension Unit is used.
 - Board Numbers 1 to 8 should be installed in the WJ-SX550C Matrix Switcher and Board Number 9 to 16 in the WJ-AD550 Extension Unit.
- Do not install more than 9 boards in the WJ-SX550C Matrix Switcher.

Board No.	Camera In No.	SW1 Setting
1	1-8	
2	9-16	
3	17-24	
4	25-32	
5	33-40	
6	41-48	
7	49-56	
8	57-64	
9	65-72	
10	73-80	
11	81-88	
12	89-96	
13	97-104	
14	105-112	
15	113-120	
16	121-128	

■ WV-PB5504AE Video Output Board

● Appearance

① Alarm Output/Reset Output Connector (ALARM OUT/RESET OUT)

External Timing Input Connector (EXT TIMING IN)
Recover Input Connector (RECOVER IN)

ALARM OUT: When the Matrix Switcher receives an alarm from the WV-PB5564E Alarm Board or camera site receivers WV-RC100, WV-RC150 or WV-RC170, the alarm output signal is provided at this connector for the Time Lapse VTR.
The active pin number of the alarm output depends on the alarm mode set by the on-screen program (Mode-1, Mode-2, Mode-3).

RESET OUT: When the Matrix Switcher resets the activated alarm, the alarm reset output signal, either Open Collector or pulse, is provided at this connector for the Time Lapse VTR.

EXT TIMING IN: The camera switching interval (Sequential Dwell Time) can be synchronized with the lapse mode set on the Time Lapse VTR.
EXT. TIMING IN 1 controls Monitor 1 output, EXT. TIMING IN 2 controls Monitor 2 output, etc.
Supply the camera switching pulse from the Time Lapse VTR to this connector.
Minimum duration for camera switching pulse needs to be one (1) second or more.

RECOVER IN: This connector accepts the alarm recover signal from the Time Lapse VTR.

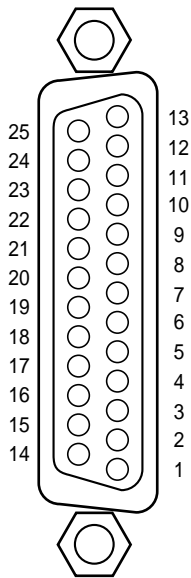

Pin No.	Designation
1	ALARM OUT 1
2	RESET OUT 1
3	RECOVER IN 1
4	Ground
5	EXT TIMING IN 1
6	Ground
7	ALARM OUT 2
8	RESET OUT 2
9	RECOVER IN 2
10	Ground
11	EXT TIMING IN 2
12	(+5V DC)
13	ALARM OUT 3
14	RESET OUT 3
15	RECOVER IN 3
16	Ground
17	EXT TIMING IN 3
18	Ground
19	ALARM OUT 4
20	RESET OUT 4
21	RECOVER IN 4
22	Ground
23	EXT TIMING IN 4
24	Ground
25	Ground

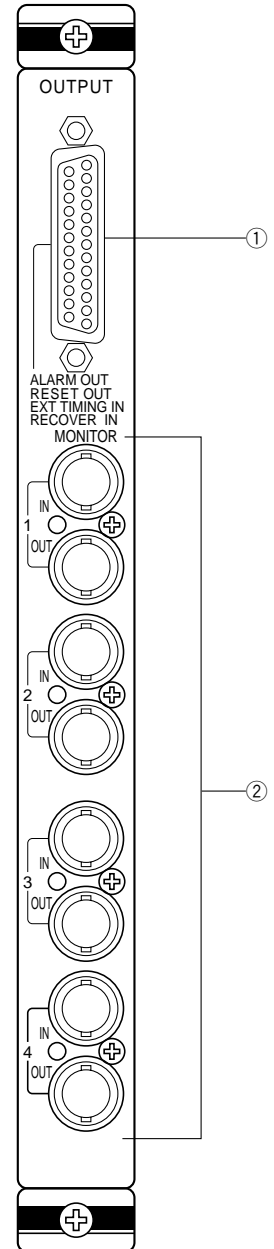

② Monitor Input/Output Connector (MONITOR IN/OUT)

OUT: Outputs the video signal selected by the Matrix Switcher for the video monitor.

IN: This connector is used for video input from a VTR or for expanding the system to 128 camera inputs.

● Board Setting

Before installing this board, the following settings should be made by qualified service personnel or system installers.

- Set switches (SW1) on the board to designate the monitor output board number as shown in the following table. The factory default setting is Board Number 1.

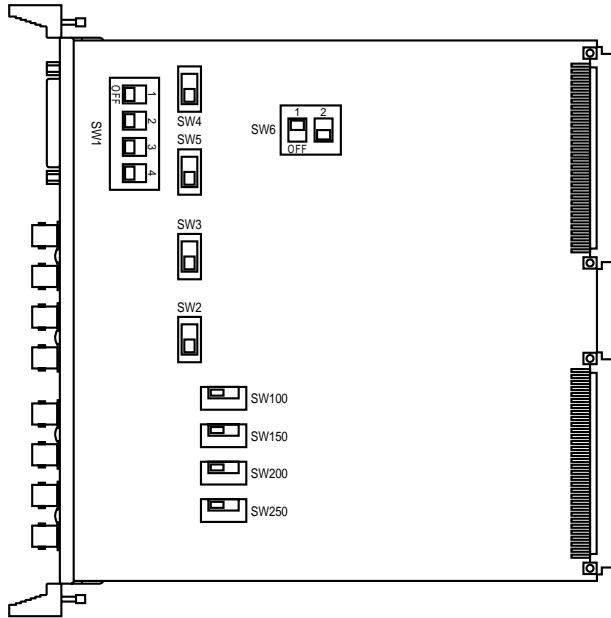

Cautions

- Board Numbers 5 to 8 are only used when the WJ-AD550 Extension Unit is used.
- Board Numbers 1 to 4 should be installed in the WJ-SX550C Matrix Switcher and Board Number 5 to 8 in the WJ-AD550 Extension Unit. Do not install more than 5 boards in the WJ-SX550C Matrix Switcher.

Board No.	Monitor Out No.	SW1 Setting
1	1-4	
2	5-8	
3	9-12	
4	13-16	
5	1-4	
6	5-8	
7	9-12	
8	13-16	

- Set switches (SW2/SW3/SW4/SW5) on the board to meet the alarm reset output requirement as either Open Collector (OPEN C.) or Pulse (VTR). The factory default setting is Pulse (VTR).

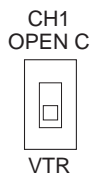

Open Collector (OPEN C.): 16 V DC 100 mA max.
Pulse (VTR): +5 V DC approx. 500 ms

Note: Be careful when setting these switches as the switches are not physically located on the board in numerical order. Switch location from the top of the board, going downward, is: SW4 (reset out 3), SW5 (reset out 4), SW3 (reset out 2) and SW2 (reset out 1).

- Set switches (SW100/SW150/SW200/SW250) on the board to meet the character display requirement on the monitor screen. The factory default setting is normal (NOR).

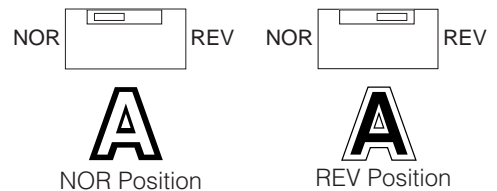

NOR: White with Black Border
REV: Black with White Border

- Confirm that switches (SW6) on the board are set as follows.

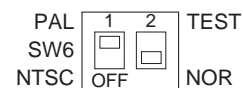

Note: These switches are used only for factory test. Always keep these switches in the positions above in the field.

WV-CU550CJ System Controller

■ Appearance

● Front View

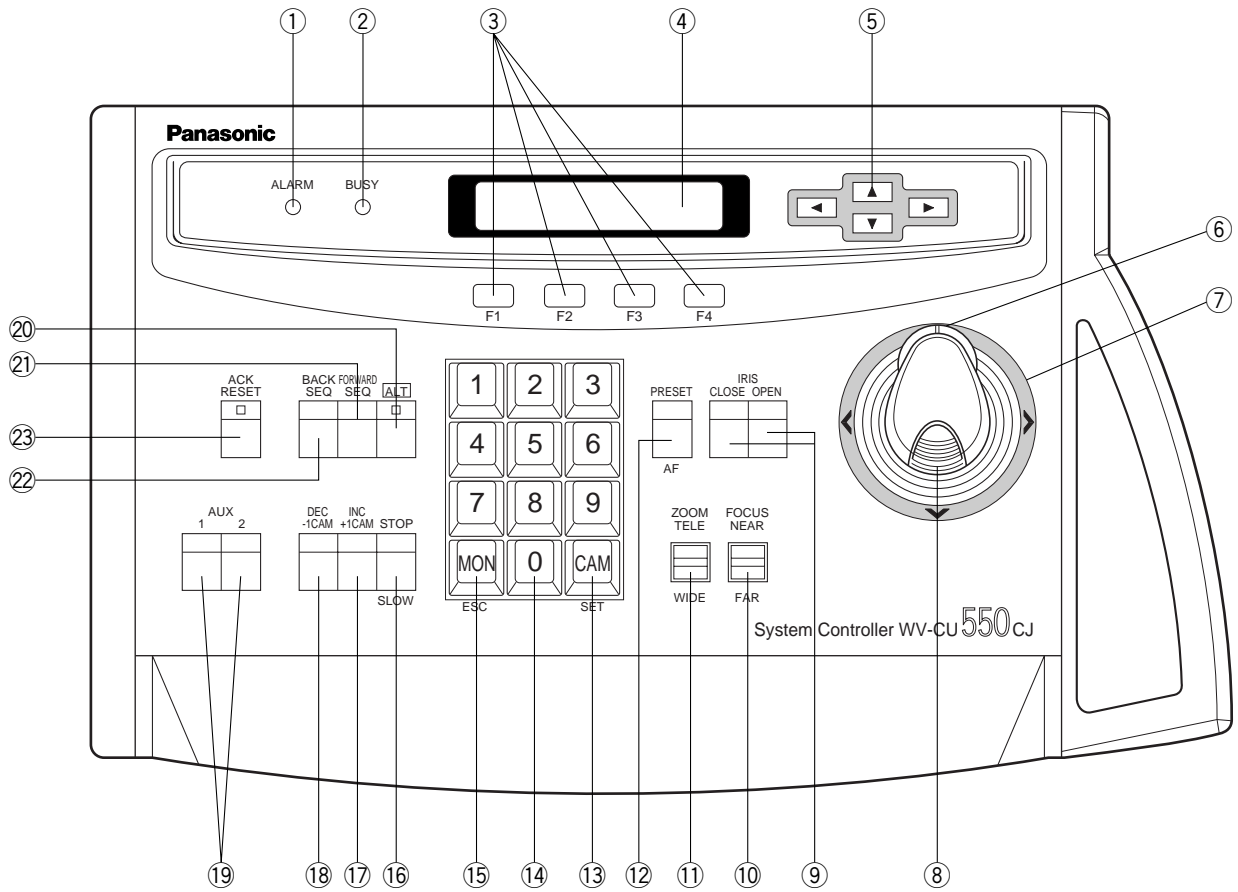

● Rear View

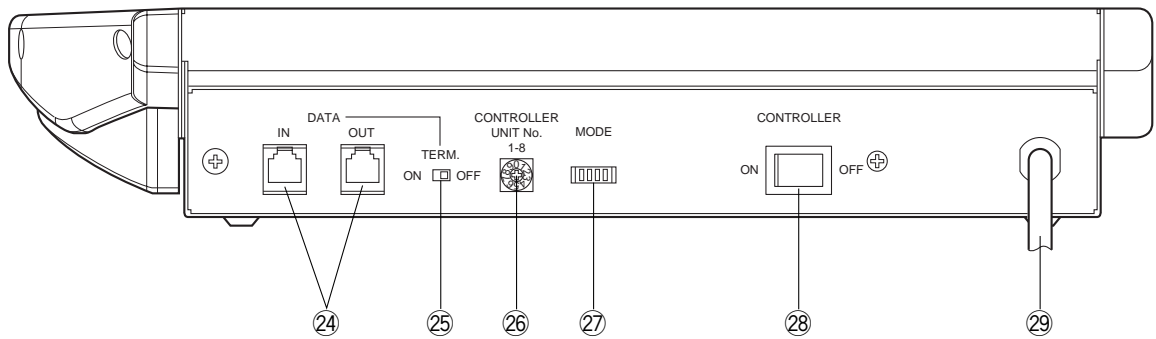

2

① Alarm Indicator (ALARM)

Blinks to indicate that an alarm condition exists. It changes to steady light when the alarm is reset automatically. To turn the indicator off, press the ACK RESET button.

② Busy Indicator (BUSY)

Lights up when you attempt to control a monitor or a camera that is already used by a higher priority operator, or when the higher priority operator selects the monitor or camera you are currently operating. Operations from the System Controller are disabled until this indicator goes off.

③ Function Buttons (F1/F2/F3/F4)

Select functions displayed on the LCD (Liquid Crystal Display) display.

④ LCD (Liquid Crystal Display) Display

Displays function menus, numeric input, and system status.

⑤ Direction Buttons (◀, ▶, ▲, ▼)

Select a function menu for display on the LCD display.

⑥ Zoom Wheel Controller

This control is used for zooming cameras equipped with the specified lens. Moving the control to the right will zoom in the image. Moving the control to the left will zoom out the image.

⑦ Joystick Controller (UP/DOWN/LEFT/RIGHT)

The joystick is used to manually operate the Pan/Tilt Head, or move the cursor in the Matrix Switcher's Setup Menu on the active monitor screen.

⑧ Top Button

Pressing this button will automatically set the lens focus of a specified camera.

⑨ Iris Control Buttons (IRIS CLOSE, OPEN)

Close or open the lens iris of cameras equipped with the specified lens. When these buttons are pressed at the sometime for 3 seconds or more, the lens iris is reset to the factory default setting.

⑩ Focus Control (FOCUS NEAR/FAR)

Adjust the lens focus of cameras equipped with the specified lens.

⑪ Zoom Control (ZOOM TELE/WIDE)

This control is used for zooming cameras equipped with the specified lens.

⑫ Preset Button (PRESET)

Auto Focus Button (AF)

PRESET: This button, in combination with the Numeric keys, is used to move the selected camera to a preset position in a system equipped with the specified cameras.

AF: Pressing this button will automatically set the lens focus of a specified camera.

⑬ Camera (Set) Key [CAM (SET)]

CAM: Used for camera selection. To select a camera, enter the desired camera number with the Numeric keys, and then press the CAM key.

SET: This key, in combination with the Numeric keys, is used to enter numeric input, such as operator ID and password.

It is also used to execute the currently highlighted selection and to enter a submenu in the Setup Menu of the Matrix Switcher.

⑭ Numeric Keys (0 to 9)

These keys are used for numeric input into the system, such as the camera and monitor number, sequence number, preset position, etc.

⑮ Monitor (Escape) Key [MON (ESC)]

MON: This key is used to select a monitor.

To select a monitor, press the corresponding Numeric keys, followed by the MON key.

ESC: This key is used to escape from the currently highlighted selection on the Setup Menu of the Matrix Switcher.

Pressing this key, while the Alternate (ALT) indicator is on, will display the video that is connected to the Monitor Input (MONITOR IN) Connector on the WV-PB5504AE Video Output Board.

⑯ Stop/Slow Button (STOP/SLOW)

STOP: Pauses a sequence that is being run on the active monitor.

SLOW: For fine pan/tilt control, move the joystick while holding down the SLOW button.

⑰ Increment Button (INC +1CAM)

When a sequence running in forward direction has been paused with the STOP button, pressing this button will move the sequence one frame to the next step (in forward run direction). If the sequence was running in reverse direction, the button will move the sequence one frame to the next step (in reverse run direction).

This button is also used to select a camera. Pressing this button will replace the currently selected camera with the next higher camera number, if the active monitor is in Spot mode.

⑱ Decrement Button (DEC -1CAM)

When a sequence running in forward direction has been paused with the STOP button, pressing this button will move the sequence one frame to the previous step (in forward run direction). If the sequence was running in reverse direction, the button will move the sequence one frame to the previous step (in reverse run direction).

This button is also used to select a camera. Pressing this button will replace the currently selected camera with the next lower camera number, if the active monitor is in Spot mode.

⑲ Auxiliary Button (AUX 1, 2)

These buttons toggle the auxiliary switches in the Receiver on and off.

The auxiliary switches can be used, for example, to activate equipment connected to the receiver, such as lamps and buzzers.

⑳ Alternate Button (ALT)

This button activates the alternate function of dual-function control buttons.

㉑ Forward Sequence Button (FORWARD SEQ)

This button is used to run a selected Program or Tour Sequence in forward direction on the active monitor.

It also restarts a sequence forward from the step that was previously paused by pressing the Stop button.

㉒ Backward Sequence Button (BACK SEQ)

This button is used to restart a sequence backward from the step that was previously paused by pressing the Stop button.

㉓ Alarm Acknowledge and Reset Button (ACK RESET)

This button cancels an activated alarm. To cancel an alarm, first select the alarmed monitor(s), then press the ACK RESET button once for alarm acknowledgment (the indicator on the button blinks rapidly), and finally press it again for alarm reset (the indicator goes off).

After an alarm acknowledgment, pressing this button while the Alternate (ALT) indicator is on will cancel all currently activated alarms at the same time.

㉔ Data Ports (DATA IN, OUT)

Exchanges control data with the WJ-SX550C Matrix Switcher in a system.

㉕ Termination Switch (TERM ON/OFF)

This switch enables termination of the controller's data port.

㉖ Controller Unit Number Switch (CONTROLLER UNIT NO.)

This switch is used to identify the unit number of the System Controller in multiple system controller applications. Up to eight controllers can be installed in a system.

㉗ Mode Selection Switch (MODE)

These switches are used to set the mode of the System Controller connected to the Matrix Switcher. Set the switches as shown below.

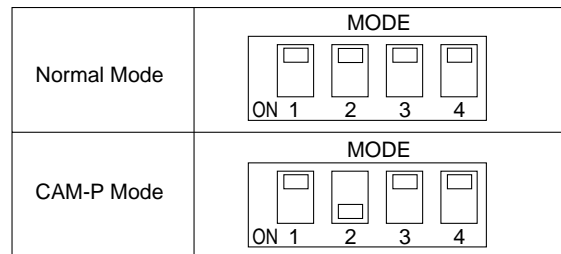

㉘ Controller On/Off Switch (CONTROLLER ON/OFF)

This switch is used to turn the WV-CU550CJ system controller power on and off.

㉙ AC Power Cord

WJ-AD550 Extension Unit

■ Appearance

● Front View

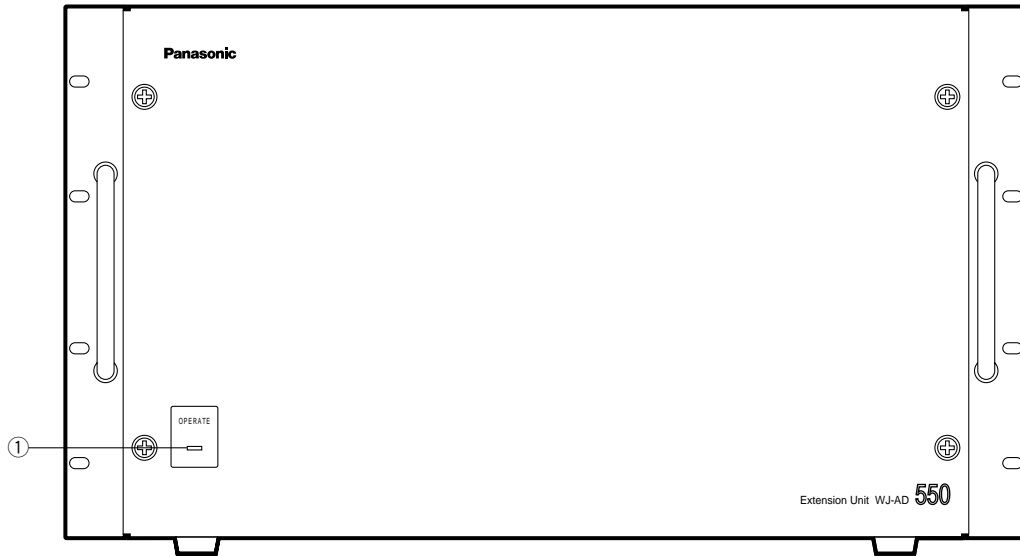

● Rear View

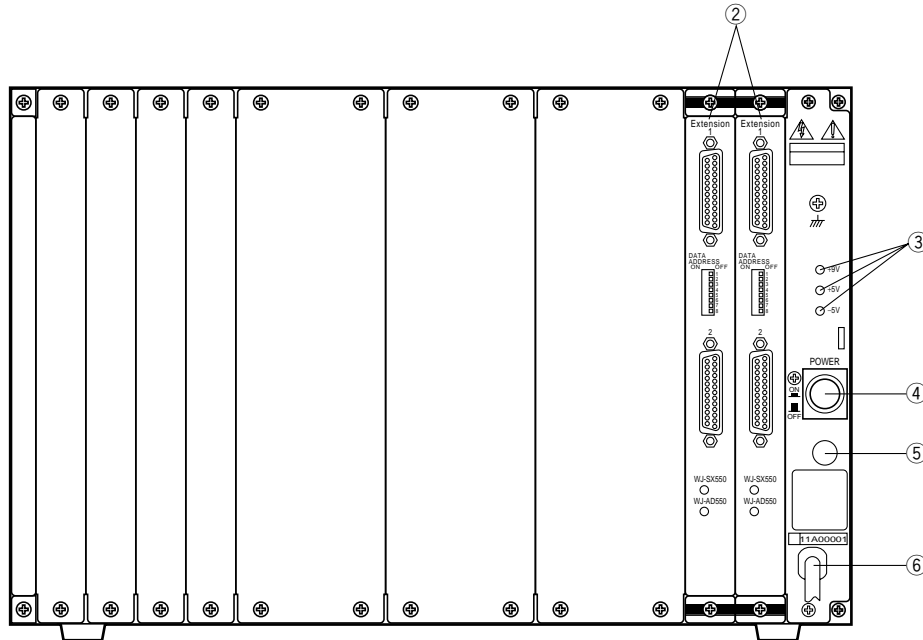

① **Operate Indicator (OPERATE)**

Is on when the power of the WJ-AD550 Extension Unit is turned on.

② **Extension Board (EXTENSION)**

One of these boards is installed in the WJ-SX550C Matrix Switcher. Connect these boards using the 25-pin connection cables supplied to expand the Matrix Switcher system.

Refer to the Extension Board on page 35 for more details.

③ **Voltage Indicator (+9V, +5V, -5V)**

These LEDs indicate the presence of +9 V, +5 V and -5 V regulated DC voltages.

④ **Power Switch (POWER ON/OFF)**

This switch is used to turn the Extension Unit power on and off.

⑤ **Fuse Holder**

⑥ **AC Power Cord**

■ Extension Board

● Appearance

① Extension Port (1, 2)

These ports are used to expand the Matrix Switcher System.

Connect between these ports on the boards installed in the WJ-SX550C Matrix Switcher and the WJ-AD550 Extension Unit.

② Data Address Switch (DATA ADDRESS ON/OFF)

These switches are used to identify the unit address number of the WV-PB5548E Data Board installed in the WJ-AD550 Extension Unit.

Set switches on the board installed in the WJ-SX550C Matrix Switcher to the "ON" position designate the Data Board Number.

③ WJ-SX550 Indicator (WJ-SX550)

This indicator lights up if the board is installed in the WJ-SX550C Matrix Switcher after the proper board settings are made.

④ WJ-AD550 Indicator (WJ-AD550)

This indicator lights up if the board is installed in the WJ-AD550 Extension Unit after the proper board settings are made.

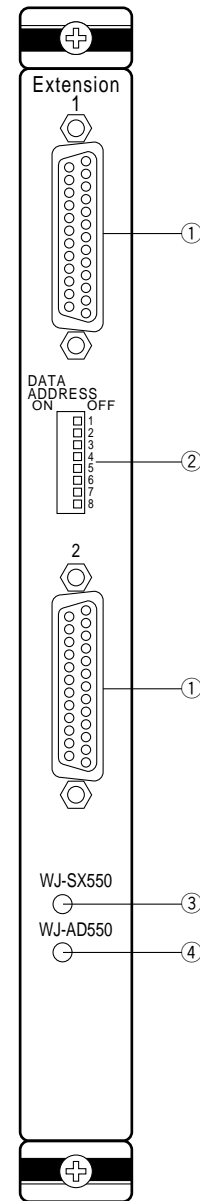

● Board Setting

Before installing this board, the following settings should be made by qualified service personnel or system installers.

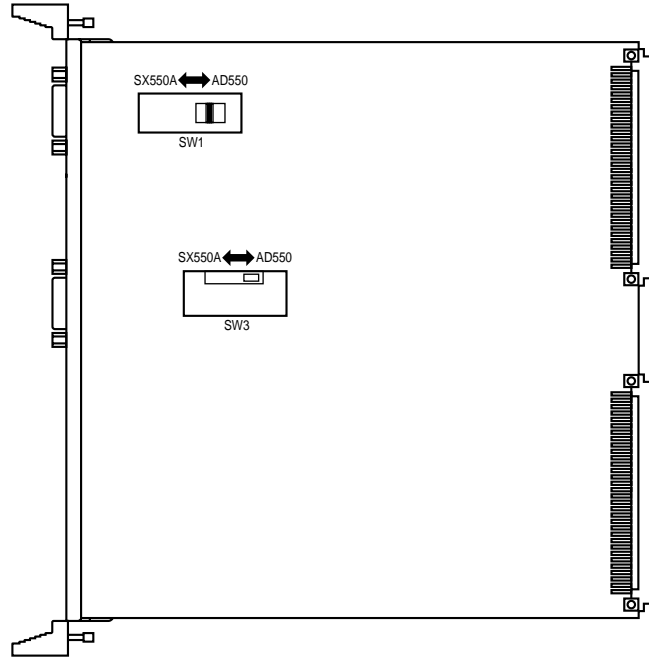

1. Set switches (SW1 and SW3) on the board to reflect the system configuration as shown below.

SX550A: Set to this position when the board is installed in the WJ-SX550C Matrix Switcher.

AD550: Set to this position when the board is installed in the WJ-AD550 Extension Unit.

The factory default setting is AD550 position.

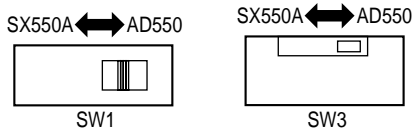

2. Set the Data Address Switch on the board to designate the WV-PB5548E Data Boards as shown below.

- 1) Board installed in the WJ-SX550C

Set the switches to the "ON" positions to designate the Data Boards where installed in the WJ-AD550 Extension Unit.

For example, if two Data Boards (Board Number 1 and 2) are installed in the WJ-AD550, set switches (1 and 2) to the "ON" position.

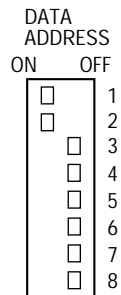

- 2) Board installed in the WJ-AD550

Always keep these switches in the "OFF" positions in the field.

The factory default settings are OFF.

WV-PB5564E Alarm Board

■ Appearance

① Alarm Number Display

Indicates the alarm input number when an alarm is received from the associated alarm sensor.

Note: The display indicator lights up as shown below when the alarm number is over one hundred.

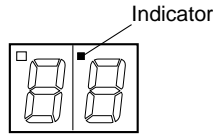

② Mode Selection Switch (MODE)

This rotary switch, in combination with the Test button, is used to select the alarm test mode.

Mode 0: Press the Test button to receive an alarm number display in chronological order from the internal memory which stores all alarms received from the Alarm Input Ports.

Mode 1: Press the Test button to simulate receiving alarm inputs 1-64 in ascending order, one alarm per second.
Use this mode to test the system for Alarm Mode-1, Mode-2 or Mode-3 setup.

Mode 2: Press the Test button to simulate receiving alarm inputs 1-64 all at the same time.
Use this mode to test the system for Alarm Mode-1, Mode-2 or Mode-3 setup.

Mode 3-9: These modes are not available.

Note: Alarm inputs 65-128 are activated in the above modes if SW1 on the board is set to Board Number 2. Refer to the Board Setting on page 39.

③ Test Button (TEST)

This button is used to run the alarm test mode in combination with the Mode Selection Switch.

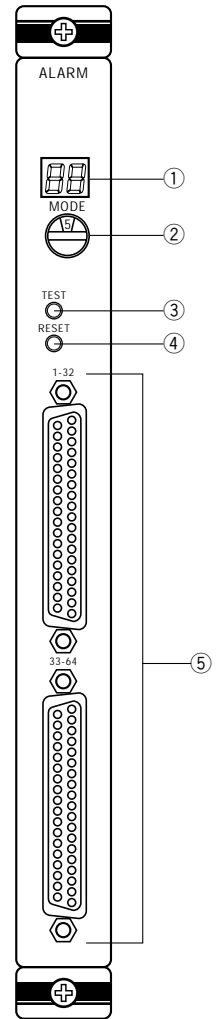

④ Reset Button (RESET)

Resets the alarm test mode or clears alarm records from the internal memory.

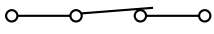
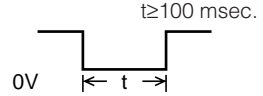
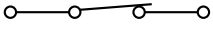

⑤ Alarm Input Port (1-32, 33-64)

This port accepts alarm input from the associated alarm sensors through either Normally Open or Normally Closed contacts.

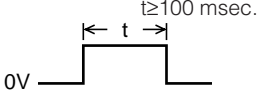
	Normal Condition	Alarm In	Alarm Signal
Normally Open (NOR OPEN)	(Open) Alarm Sensor 	(Close) Alarm Sensor 	
Normally Closed (NOR CLOSE)	(Close) Alarm Sensor 	(Open) Alarm Sensor 	

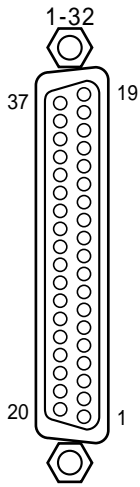

Pin No.	Designation		Pin No.	Designation	
	Board No.1	Board No.2		Board No.1	Board No.2
1	Alarm 1	Alarm 65	20	Alarm 20	Alarm 84
2	Alarm 2	Alarm 66	21	Alarm 21	Alarm 85
3	Alarm 3	Alarm 67	22	Alarm 22	Alarm 86
4	Alarm 4	Alarm 68	23	Alarm 23	Alarm 87
5	Alarm 5	Alarm 69	24	Alarm 24	Alarm 88
6	Alarm 6	Alarm 70	25	Alarm 25	Alarm 89
7	Alarm 7	Alarm 71	26	Alarm 26	Alarm 90
8	Alarm 8	Alarm 72	27	Alarm 27	Alarm 91
9	Alarm 9	Alarm 73	28	Alarm 28	Alarm 92
10	Alarm 10	Alarm 74	29	Alarm 29	Alarm 93
11	Alarm 11	Alarm 75	30	Alarm 30	Alarm 94
12	Alarm 12	Alarm 76	31	Alarm 31	Alarm 95
13	Alarm 13	Alarm 77	32	Alarm 32	Alarm 96
14	Alarm 14	Alarm 78	33	Not used	Not used
15	Alarm 15	Alarm 79	34	Not used	Not used
16	Alarm 16	Alarm 80	35	Not used	Not used
17	Alarm 17	Alarm 81	36	Ground	Ground
18	Alarm 18	Alarm 82	37	Ground	Ground
19	Alarm 19	Alarm 83			

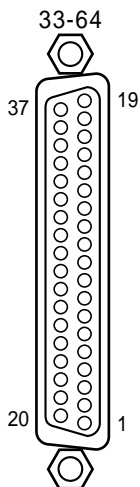

Pin No.	Designation		Pin No.	Designation	
	Board No.1	Board No.2		Board No.1	Board No.2
1	Alarm 33	Alarm 97	20	Alarm 52	Alarm 116
2	Alarm 34	Alarm 98	21	Alarm 53	Alarm 117
3	Alarm 35	Alarm 99	22	Alarm 54	Alarm 118
4	Alarm 36	Alarm 100	23	Alarm 55	Alarm 119
5	Alarm 37	Alarm 101	24	Alarm 56	Alarm 120
6	Alarm 38	Alarm 102	25	Alarm 57	Alarm 121
7	Alarm 39	Alarm 103	26	Alarm 58	Alarm 122
8	Alarm 40	Alarm 104	27	Alarm 59	Alarm 123
9	Alarm 41	Alarm 105	28	Alarm 60	Alarm 124
10	Alarm 42	Alarm 106	29	Alarm 61	Alarm 125
11	Alarm 43	Alarm 107	30	Alarm 62	Alarm 126
12	Alarm 44	Alarm 108	31	Alarm 63	Alarm 127
13	Alarm 45	Alarm 109	32	Alarm 64	Alarm 128
14	Alarm 46	Alarm 110	33	Not used	Not used
15	Alarm 47	Alarm 111	34	Not used	Not used
16	Alarm 48	Alarm 112	35	Not used	Not used
17	Alarm 49	Alarm 113	36	Ground	Ground
18	Alarm 50	Alarm 114	37	Ground	Ground
19	Alarm 51	Alarm 115			

Board Setting

Before installing this board, the following settings should be made by qualified service personnel or system installers.

- Set switches (SW1) on the board to designate the Alarm Input board number as shown below.

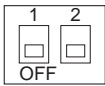
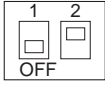
Board No.	Alarm Input No.	SW1 Setting
1	1-64	
2	65-128	

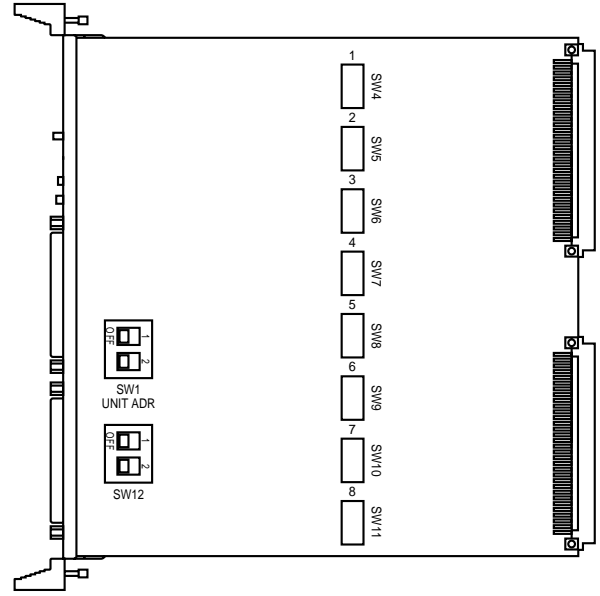
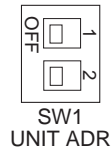

- Set switches (SW4, SW5, SW6, SW7, SW8, SW9, SW10 and SW11) on the board to meet the alarm input requirements.

NOR OPEN: Normally Open Input
NOR CLOSE: Normally Closed Input

The factory default setting is Normally Open (NOR OPEN).

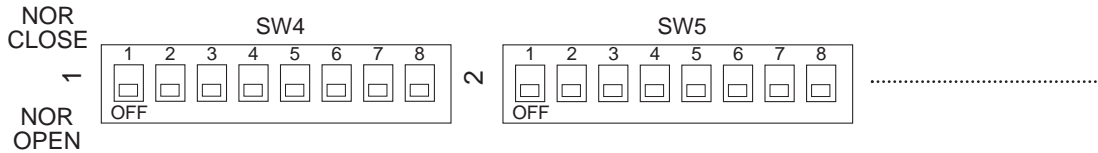

	Switch No.	Alarm Input	
		Board No.1	Board No.2
1	SW4	1 - 8	65-72
2	SW5	9 - 16	73-80
3	SW6	17 - 24	81-88
4	SW7	25 - 32	89-96
5	SW8	33 - 40	97-104
6	SW9	41 - 48	105-112
7	SW10	49 - 56	113-120
8	SW11	57 - 64	121-128

- Confirm that switches (SW12) on the board are set as follows.

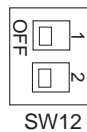

Note: These switches are used only for factory test.
 Always keep these switches in the "OFF" positions in the field.

WV-PB5548E Data Board

■ Appearance

① Data Connector (TA/TB/RA/RB/G, 1 - 8)

These connectors are used to exchange control data with the camera site equipment. For connection, use a data grade shielded 4-wire twisted pair cable suitable for RS-485 communication. Cable length may be extended up to 1 200 m (4 000 ft).

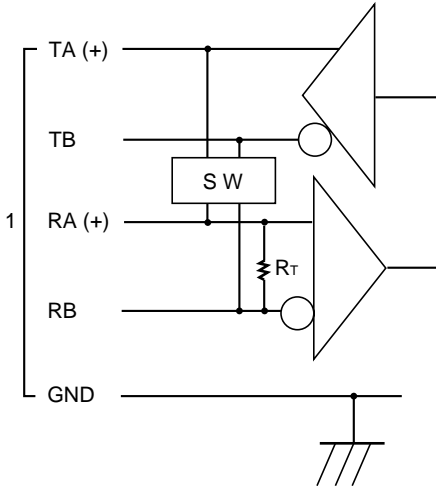

- RT: Termination Resistor, 150 Ω 1/2 W
- SW: Selection Switch, Full Duplex/Half Duplex
- GND: Ground; connected to each channel and common ground.

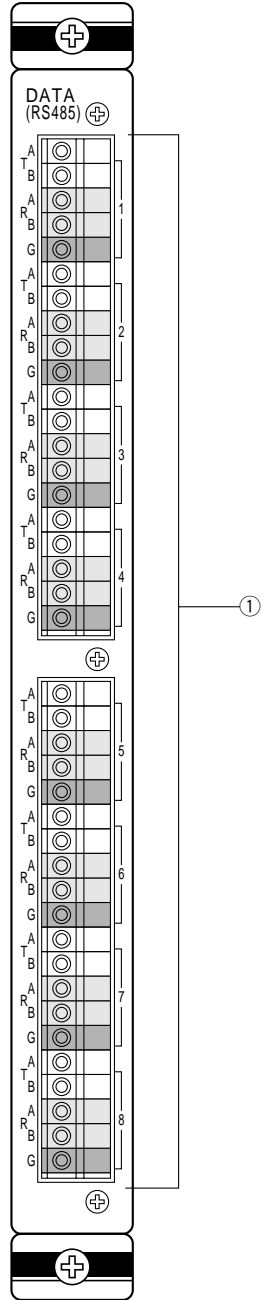

2

Board Setting

Before installing this board, the following settings should be made by qualified service personnel or system installers.

- Set switches (SW1) on the board to designate the data board number as shown in the following table.
The factory default setting is Board Number 1.

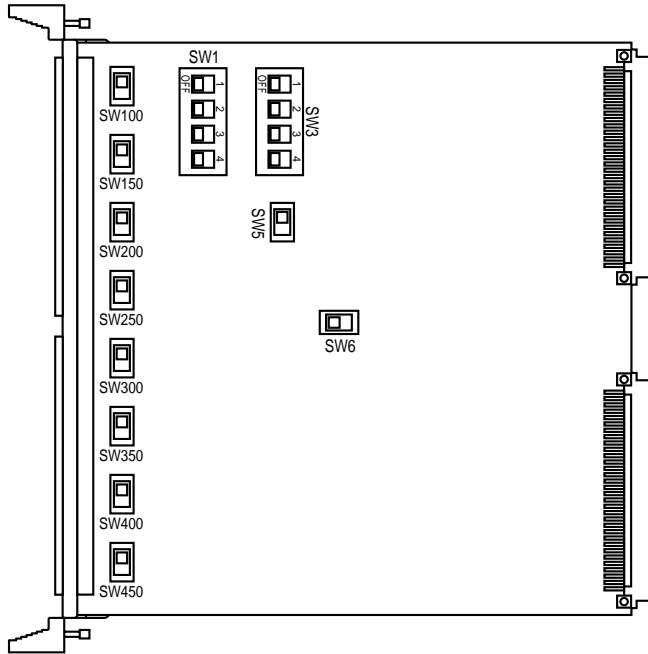

Board No.	SW1 Setting								
1	<table border="1"> <tr> <td>1</td> <td>2</td> <td>3</td> <td>4</td> </tr> <tr> <td>OFF</td> <td></td> <td></td> <td></td> </tr> </table>	1	2	3	4	OFF			
1	2	3	4						
OFF									
2	<table border="1"> <tr> <td>1</td> <td>2</td> <td>3</td> <td>4</td> </tr> <tr> <td>OFF</td> <td></td> <td></td> <td></td> </tr> </table>	1	2	3	4	OFF			
1	2	3	4						
OFF									
3	<table border="1"> <tr> <td>1</td> <td>2</td> <td>3</td> <td>4</td> </tr> <tr> <td>OFF</td> <td></td> <td></td> <td></td> </tr> </table>	1	2	3	4	OFF			
1	2	3	4						
OFF									
4	<table border="1"> <tr> <td>1</td> <td>2</td> <td>3</td> <td>4</td> </tr> <tr> <td>OFF</td> <td></td> <td></td> <td></td> </tr> </table>	1	2	3	4	OFF			
1	2	3	4						
OFF									
5	<table border="1"> <tr> <td>1</td> <td>2</td> <td>3</td> <td>4</td> </tr> <tr> <td>OFF</td> <td></td> <td></td> <td></td> </tr> </table>	1	2	3	4	OFF			
1	2	3	4						
OFF									
6	<table border="1"> <tr> <td>1</td> <td>2</td> <td>3</td> <td>4</td> </tr> <tr> <td>OFF</td> <td></td> <td></td> <td></td> </tr> </table>	1	2	3	4	OFF			
1	2	3	4						
OFF									
7	<table border="1"> <tr> <td>1</td> <td>2</td> <td>3</td> <td>4</td> </tr> <tr> <td>OFF</td> <td></td> <td></td> <td></td> </tr> </table>	1	2	3	4	OFF			
1	2	3	4						
OFF									
8	<table border="1"> <tr> <td>1</td> <td>2</td> <td>3</td> <td>4</td> </tr> <tr> <td>OFF</td> <td></td> <td></td> <td></td> </tr> </table>	1	2	3	4	OFF			
1	2	3	4						
OFF									

- Set switches (SW100, SW150, SW200, SW250, SW300, SW350, SW400 and SW450) on the board to choose either Full Duplex (FULL) or Half Duplex (HALF) communication lines as shown in the figure.
The factory default settings are Full Duplex (FULL).

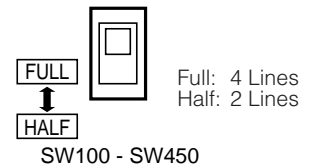

- Set switch (SW5) on the board to choose "ON" or "OFF" mode for the LED indicator.
The indicator shows that control data operations on the board are normal.
The factory default setting is ON.

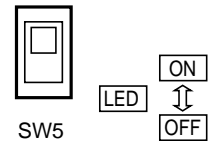

- Confirm that switches (SW3 and SW6) on the board are set as shown in the figure.

Note: These switches are used only for factory test.
Always keep these switches in the "OFF" positions in the field.

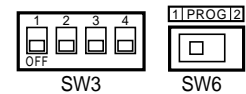

BOARD SELECTION FOR SYSTEM EXPANSION

This switcher has 15 slots, eleven of which are available for system expansion. The CPU and Control Board, along with one Video Input Board and one Video Output Board are supplied as standard accessories.

Depending on the number of camera inputs and monitor outputs required, additional WV-PB5508E Video Input Boards and WV-PB5504AE Video Output Boards will be required.

● WJ-SX550C Matrix Switcher

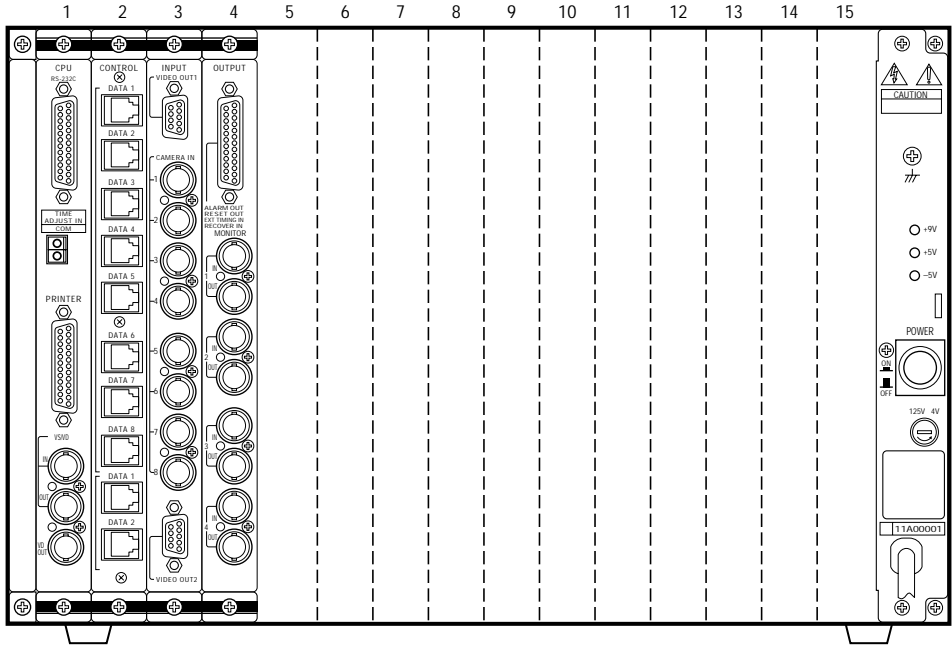

The Extension Unit has also 15 slots and has two Extension Boards installed.

● WJ-AD550 Extension Unit

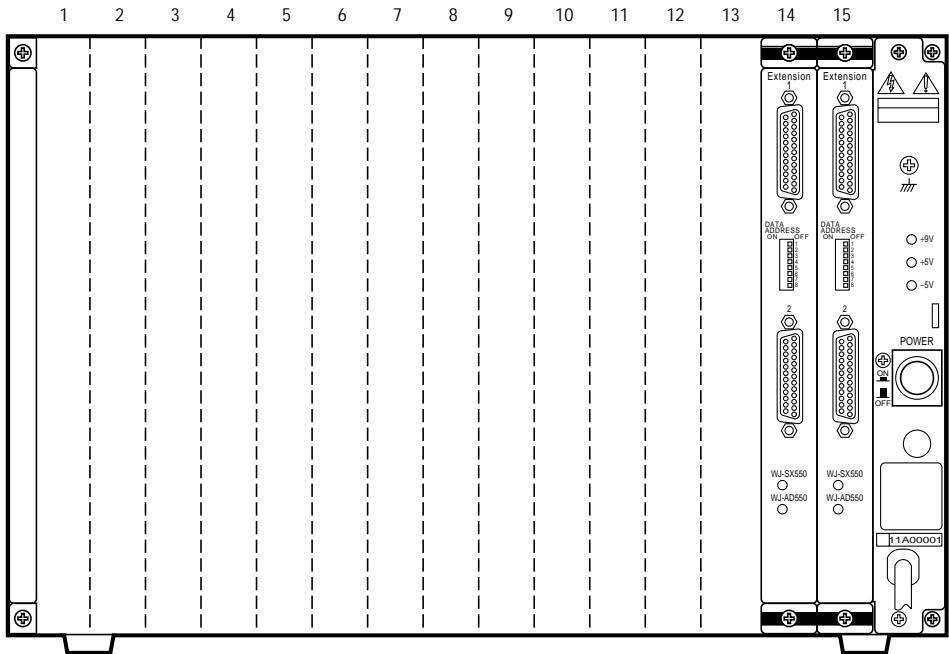

2

The tables below show the components required for various system configurations.

2

Cameras	Monitors	Extension Unit WJ-AD550	Input Boards WV-PB5508E	Output Boards WV-PB5504AE	Slots Used	Slots Left
1 - 8	1 - 4	not required	1	1	4	11
9 - 16	1 - 4	not required	2	1	5	10
17 - 24	1 - 4	not required	3	1	6	9
25 - 32	1 - 4	not required	4	1	7	8
33 - 40	1 - 4	not required	5	1	8	7
41 - 48	1 - 4	not required	6	1	9	6
49 - 56	1 - 4	not required	7	1	10	5
57 - 64	1 - 4	not required	8	1	11	4
65 - 72	1 - 4	required	9	2	15	15
73 - 80	1 - 4	required	10	2	16	14
81 - 88	1 - 4	required	11	2	17	13
89 - 96	1 - 4	required	12	2	18	12
97 - 104	1 - 4	required	13	2	19	11
105 - 112	1 - 4	required	14	2	20	10
113 - 120	1 - 4	required	15	2	21	9
121 - 128	1 - 4	required	16	2	22	8

Cameras	Monitors	Extension Unit WJ-AD550	Input Boards WV-PB5508E	Output Boards WV-PB5504AE	Slots Used	Slots Left
1 - 8	5 - 8	not required	1	2	5	10
9 - 16	5 - 8	not required	2	2	6	9
17 - 24	5 - 8	not required	3	2	7	8
25 - 32	5 - 8	not required	4	2	8	7
33 - 40	5 - 8	not required	5	2	9	6
41 - 48	5 - 8	not required	6	2	10	5
49 - 56	5 - 8	not required	7	2	11	4
57 - 64	5 - 8	not required	8	2	12	3
65 - 72	5 - 8	required	9	4	17	13
73 - 80	5 - 8	required	10	4	18	12
81 - 88	5 - 8	required	11	4	19	11
89 - 96	5 - 8	required	12	4	20	10
97 - 104	5 - 8	required	13	4	21	9
105 - 112	5 - 8	required	14	4	22	8
113 - 120	5 - 8	required	15	4	23	7
121 - 128	5 - 8	required	16	4	24	6

Cameras	Monitors	Extension Unit WJ-AD550	Input Boards WV-PB5508E	Output Boards WV-PB5504AE	Slots Used	Slots Left
1 - 8	9 - 12	not required	1	3	6	9
9 - 16	9 - 12	not required	2	3	7	8
17 - 24	9 - 12	not required	3	3	8	7
25 - 32	9 - 12	not required	4	3	9	6
33 - 40	9 - 12	not required	5	3	10	5
41 - 48	9 - 12	not required	6	3	11	4
49 - 56	9 - 12	not required	7	3	12	3
57 - 64	9 - 12	not required	8	3	13	2
65 - 72	9 - 12	required	9	6	19	11
73 - 80	9 - 12	required	10	6	20	10
81 - 88	9 - 12	required	11	6	21	9
89 - 96	9 - 12	required	12	6	22	8
97 - 104	9 - 12	required	13	6	23	7
105 - 112	9 - 12	required	14	6	24	6
113 - 120	9 - 12	required	15	6	25	5
121 - 128	9 - 12	required	16	6	26	4

Cameras	Monitors	Extension Unit WJ-AD550	Input Boards WV-PB5508E	Output Boards WV-PB5504AE	Slots Used	Slots Left
1 - 8	9 - 12	not required	1	4	7	8
9 - 16	9 - 12	not required	2	4	8	7
17 - 24	9 - 12	not required	3	4	9	6
25 - 32	9 - 12	not required	4	4	10	5
33 - 40	9 - 12	not required	5	4	11	4
41 - 48	9 - 12	not required	6	4	12	3
49 - 56	9 - 12	not required	7	4	13	2
57 - 64	9 - 12	not required	8	4	14	1
65 - 72	9 - 12	required	9	8	21	9
73 - 80	9 - 12	required	10	8	22	8
81 - 88	9 - 12	required	11	8	23	7
89 - 96	9 - 12	required	12	8	24	6
97 - 104	9 - 12	required	13	8	25	5
105 - 112	9 - 12	required	14	8	26	4
113 - 120	9 - 12	required	15	8	27	3
121 - 128	9 - 12	required	16	8	28	2

Notes:

- Two extension boards should be installed in the slots if the extension unit is required.
- The slots left can accommodate up to two (2) Alarm Boards or eight (8) Data Boards.

SECTION 3
INSTALLATION
AND
SYSTEM CONNECTIONS

INSTALLATIONS

The installation described below should be made by qualified service personnel or system installers and should conform to all local codes.

■ WJ-SX550C Matrix Switcher WJ-AD550 Extension Unit

● Mounting into the Rack

1. Remove four rubber feet by removing four screws from the bottom of the Matrix Switcher (Extension Unit).

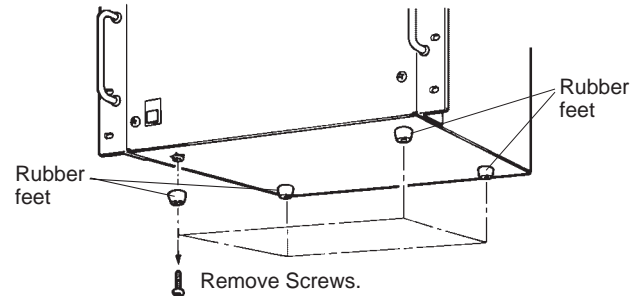

2. Install the Matrix Switcher (Extension Unit) in the rack securing it with eight screws (not included).

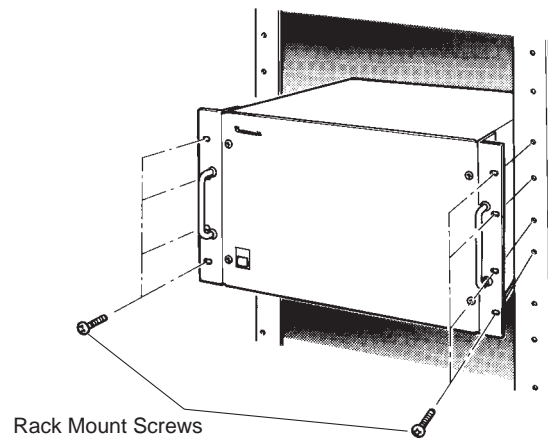

Cautions

- The cooling fans inside the Matrix Switcher (or Extension Unit) are subject to wear and need to be replaced periodically.
- Do not block the ventilation opening or slots on the cover to prevent the temperature from rising inside the unit. Always keep the temperature in the rack within 45°C (113°F).
- If the rack is subject to vibration, secure the rear of the unit to the rack using additional mounting brackets (procured locally).

■ Installing Additional Extension Boards

Before installing the additional extension boards, be sure to make the specified board settings. Refer to the board settings for each board in section 2 for further details.

● Extension Unit is not Required

Caution

Before installing any boards be sure to turn the power of the Matrix Switcher off.

1. Remove the screws from the rear panel(s) of the WJ-SX550C Matrix Switcher.
2. Remove the rear panel(s).
3. Place the Boards into the specified positions in the rear of the Matrix Switcher by sliding them along the board guides as shown below.

Note: Each slot is identical, so the boards can be installed in any slot. However it is recommended to install the boards as shown below for orderly installation.

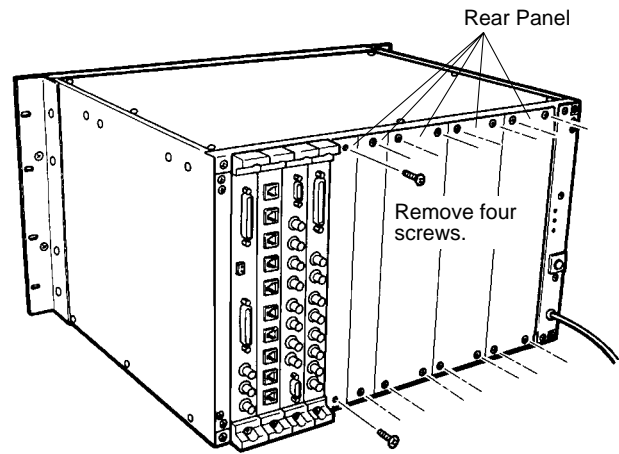

3

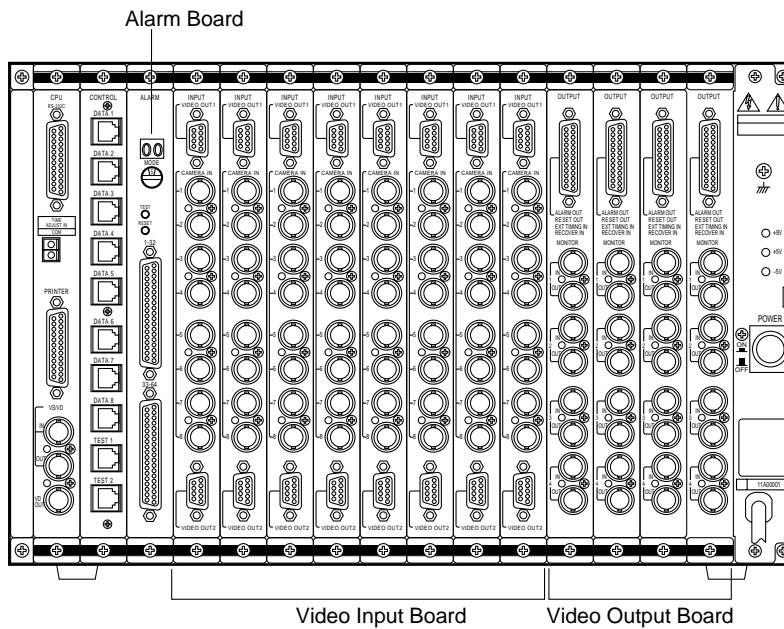

4. Make sure to push in the Boards until they are seated firmly.
5. Secure the Board by tightening the two screws on the board.
6. Close open spaces on the rear of the Matrix Switcher with the supplied rear panel(s) or the optional WV-Q63E Blank Panel(s).

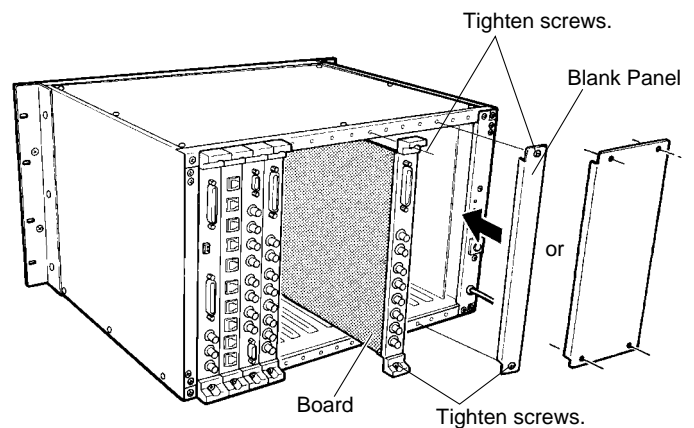

● Extension Unit is Required

Caution

Before installing any boards, be sure to turn the power of the WJ-SX550C Matrix Switcher and WJ-AD550 Extension Unit off.

When the Extension Unit is required to install the boards, follow the procedures as shown below.

● Removing Extension Boards

1. Remove the screws from rear panel(s) of the Extension Unit.

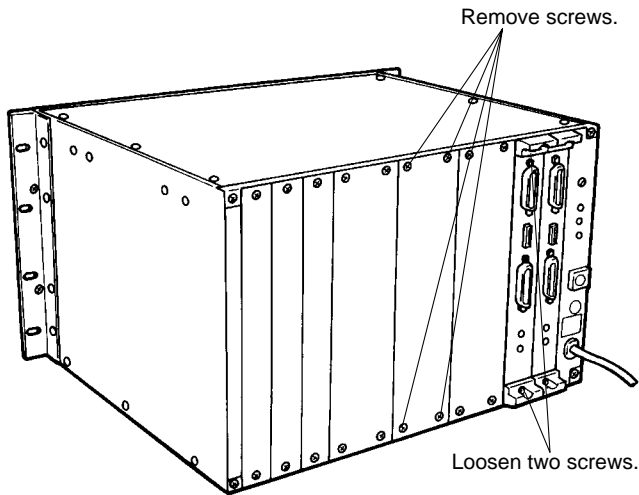

2. Remove the rear panel(s).
3. Loosen two screws on the Extension Board(s).
4. Extract the Extension Board(s) from the rear of the Extension Unit by sliding it along the board guides.

● Installing Additional Extension Boards

1. Install an Extension Board into slot number 15 of the Matrix Switcher and Extension Unit.

WJ-SX550C Matrix Switcher

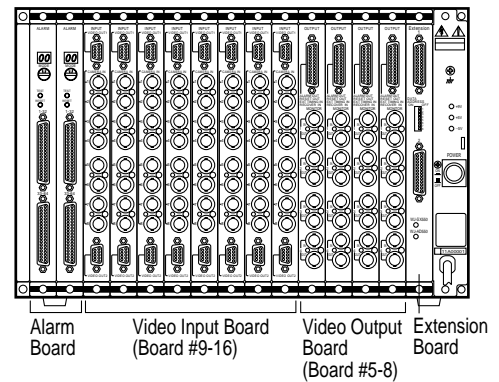
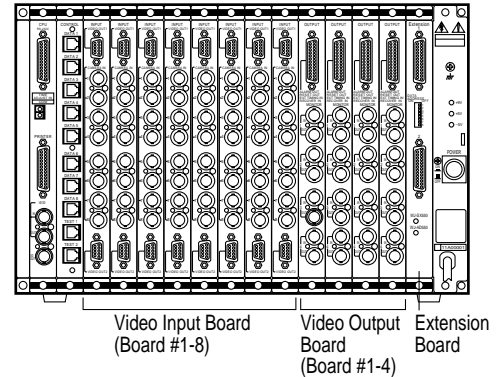

2. Install the Video Input Boards into the specified slots as shown below.
Board Number 1 to 8 go into the Matrix Switcher.
Board Number 9 to 16 go into the Extension Unit.
3. Install the Video Output Boards into the specified slots as shown below.
Board Number 1 to 4 go into the Matrix Switcher.
Board Number 5 to 8 go into the Extension Unit.

Notes:

- Up to two Alarm Boards or eight Data Boards can be installed in the Matrix Switcher and Extension Unit.
When the Data Boards are installed in the Extension Unit, be sure to set the Data Address Switch on the Extension Boards to the specified positions.
- It is recommended to install the boards as shown in the figure for orderly installation.

SYSTEM CONNECTIONS

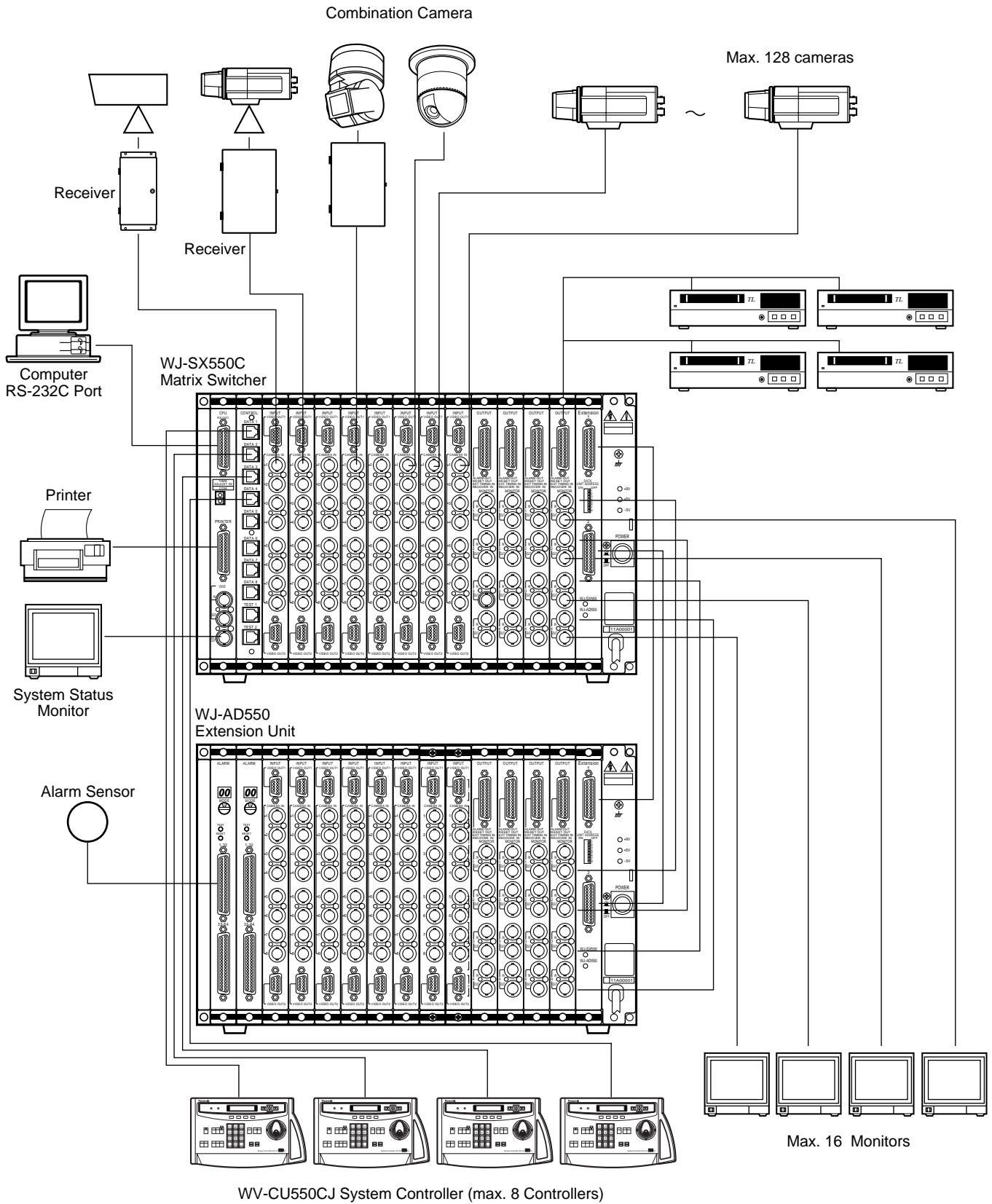

3

Note: Refer to the Operating Instructions of the WJ-AD550 Extension Unit for connections when the WJ-AD550 Extension Unit is used.

Overview of System Connections

■ Connection with the Camera Sites

Connect the Camera Site Equipment to the Camera Input Connectors (CAMERA IN, 1-8) on the Video Input Board(s).

Note: Make sure that the cable length between the camera site and the WJ-SX550C Matrix Switcher is less than 1 200 m (4 000 ft) when using RG-6/U or equivalent cable.

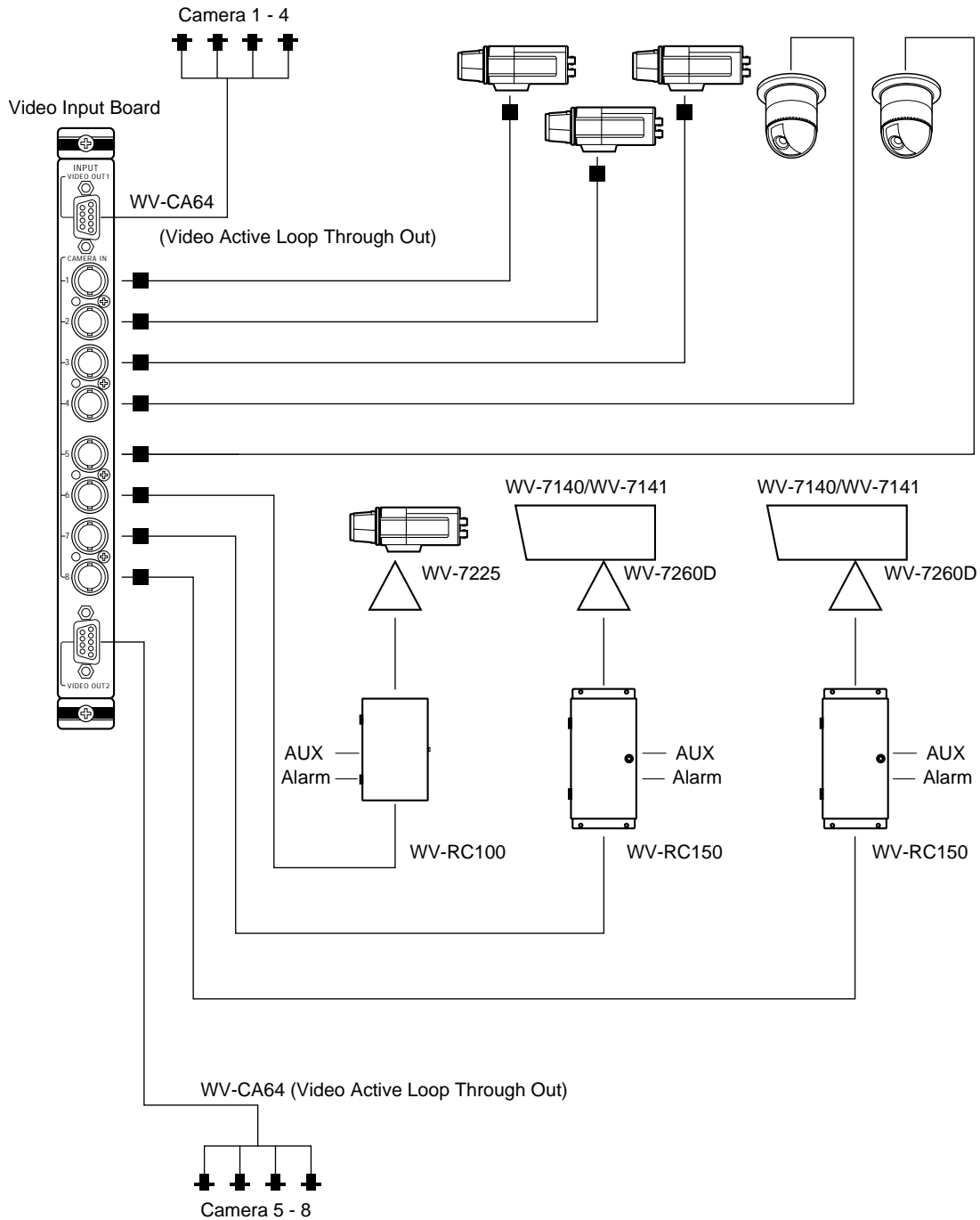

Connection with the Camera Sites

■ Connection with the Monitors and Time Lapse VTRs

Connect the Monitors to the Monitor Output Connectors (MONITOR OUT) on the Video Output Board(s).
Connect the Time Lapse VTR as shown in the example below.

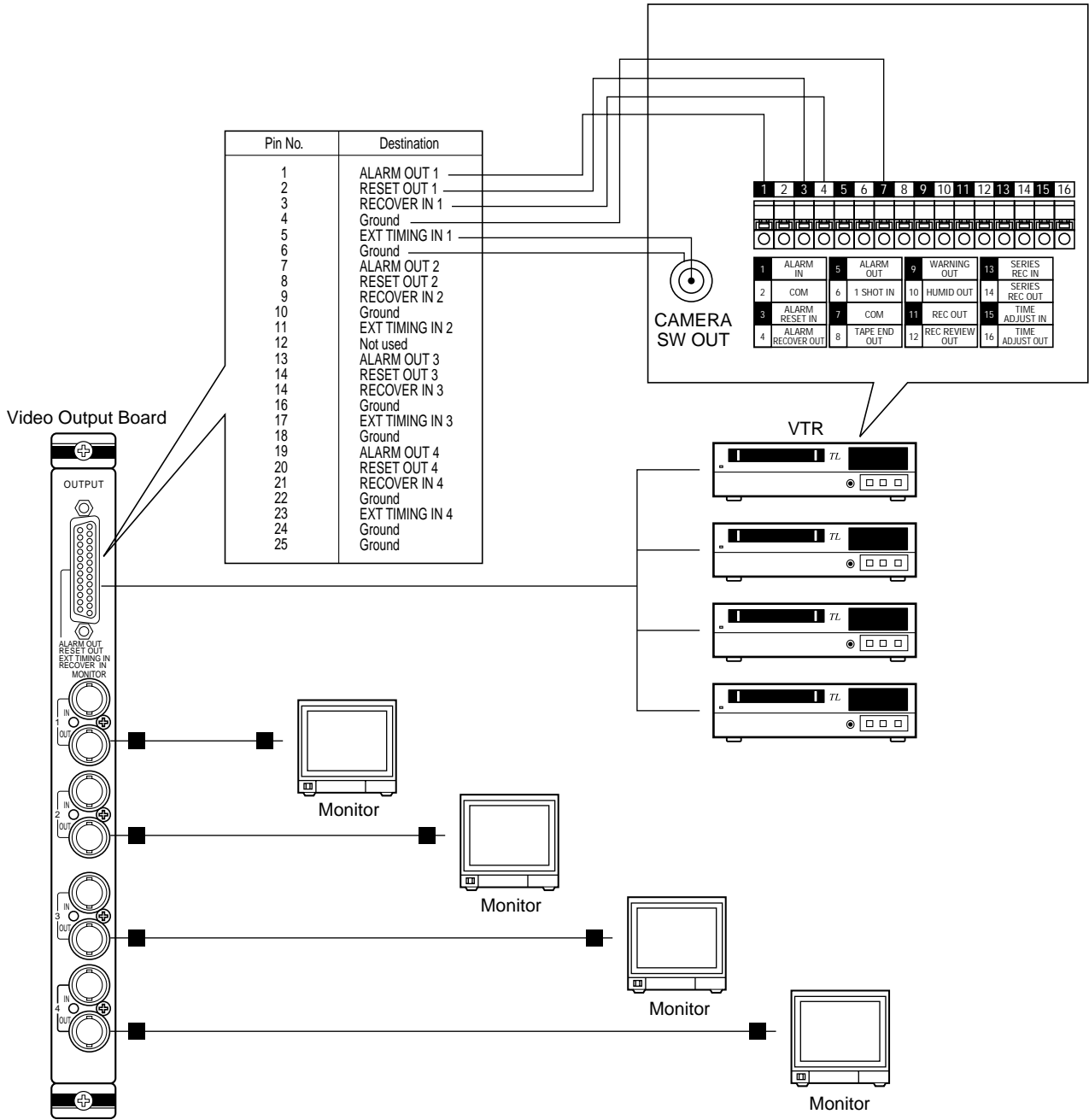

Connection with the Monitors and Time Lapse VTRs

■ Connection with the System Controllers

● Data Line Connection

Up to eight WV-CU550CJ System Controllers can be installed in a Matrix System.

The Control Board installed in the WJ-SX550C Matrix Switcher has eight ports that correspond to eight WV-CU550CJ System Controller inputs.

If the supplied 6-conductor cable assembly is used, simply plug one end of the cable into a port on the Control Board and the other end into one of the ports on the rear of the System Controller.

If you use cables assembled from locally procured materials, it is important that only high quality, data grade cable, suitable for RS-485 communication (shielded 4-wire twisted pair cable) is used.

Low grade cable will result in unstable operation of the system.

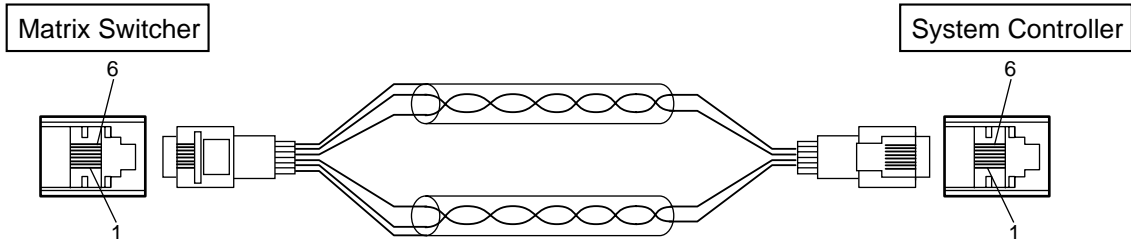

Pin No.	Designation		Direction
	Control Board	System Controller	
1	Ground	Ground	
2	RB	TB	Switcher ← Controller
3	RA	TA	Switcher ← Controller
4	TB	RB	Switcher ← Controller
5	TA	RA	Switcher ← Controller
6	Ground	Ground	

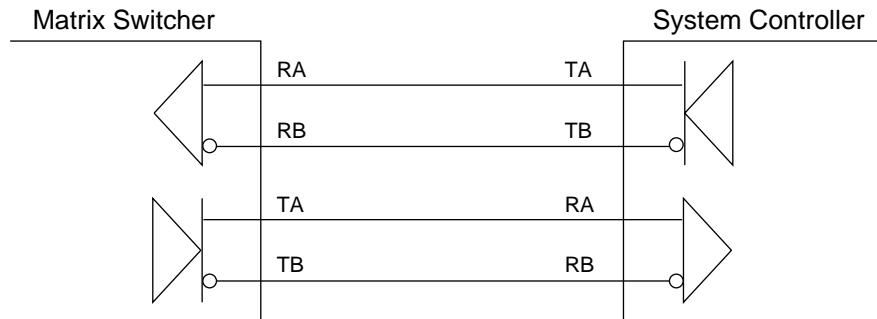

● Mode Selection Switch Setting

The Mode Selection Switch, that selects the operation mode of the System Controller, is located on the rear of the System Controller. Set the switches to meet the system requirement as shown below.

Normal Mode	OFF ON
CAM-P Mode	OFF ON

Normal Mode: Enables selection of function menus on the LCD display, except the CAM-P (D5) Menu.

CAM-P Mode: Enables selection of the CAM-P (D5) Menu on the LCD display, including the menus available in Normal Mode. Choose this mode to use the Camera Position functions.

Set the mode before turning the System Controller's power on.

Once the System Controller's power has been turned on, the mode is fixed. The factory default setting is Normal Mode.

● Direct Connection to the Control Board (“Home Run” Type Wiring)

In this type of installation there is one control cable directly connecting each System Controller to one Control Board port. Refer to the connections and controller settings in the figure shown below.

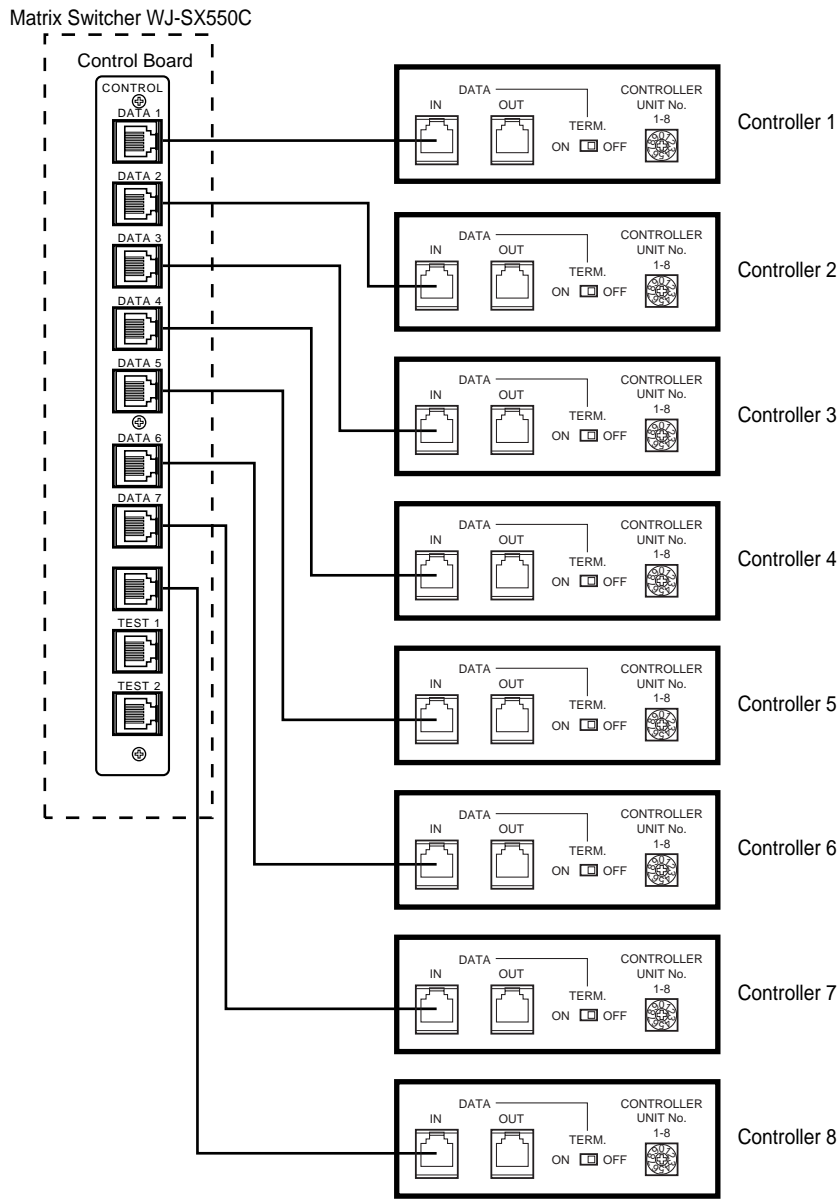

Home Run Connections

Termination and Controller Unit Number Setting

	Termination Switch	Controller Unit Number
Controller 1	ON	0
Controller 2	ON	0
Controller 3	ON	0
Controller 4	ON	0
Controller 5	ON	0
Controller 6	ON	0
Controller 7	ON	0
Controller 8	ON	0

Notes:

- Do not set “1” to “9” for controller unit numbers.
- Confirm that the jumper connector (CN13) on the Control Board is positioned as shown below.

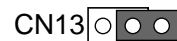

3

● Indirect Connection to the Control Board (“Daisy-Chain” Type Wiring)

In this type of installation only one control cable directly connects between the System Controller #1 and the Control Board. The rest of the System Controllers connect to System Controller #1 in a Daisy-Chain connection. Refer to the connections and controller settings in the figure shown below.

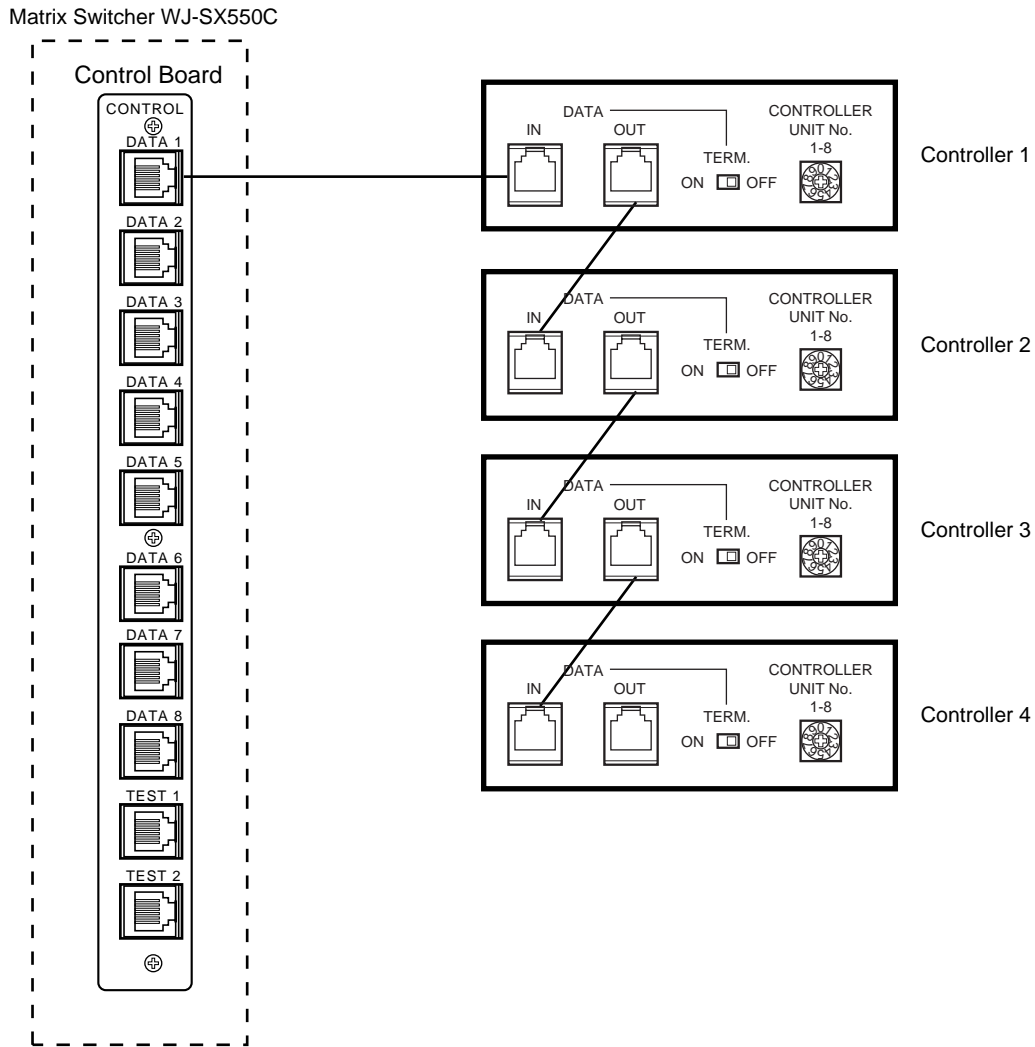

Daisy-Chain Connections

Notes:

- To avoid unstable operation, do not connect more than 4 System Controllers in a daisy-chain connection.
- The response may be poorer in a daisy-chain connection. To operate multiple System Controllers at the same time, it is recommended to use a Home Run connection.
- Confirm that the jumper connector (CN13) on the Control Board is positioned as shown below.

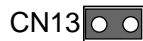

Termination and Controller Unit Number Setting

	Termination Switch	Controller Unit Number
Controller 1	OFF	1
Controller 2	OFF	2
Controller 3	OFF	3
Controller 4	ON	4

Note: Do not set “0” or “9” for controller unit numbers.

**● Combination of Direct and Indirect Connections
(Both “Home Run” and “Daisy-Chain” Wiring in One System)**

In this type of installation there is a mixture of wiring methods, with some System Controllers connecting directly to the Control Board while other System Controllers connect to the Control Board through other System Controllers. Refer to the connections and controller settings in the figure shown below.

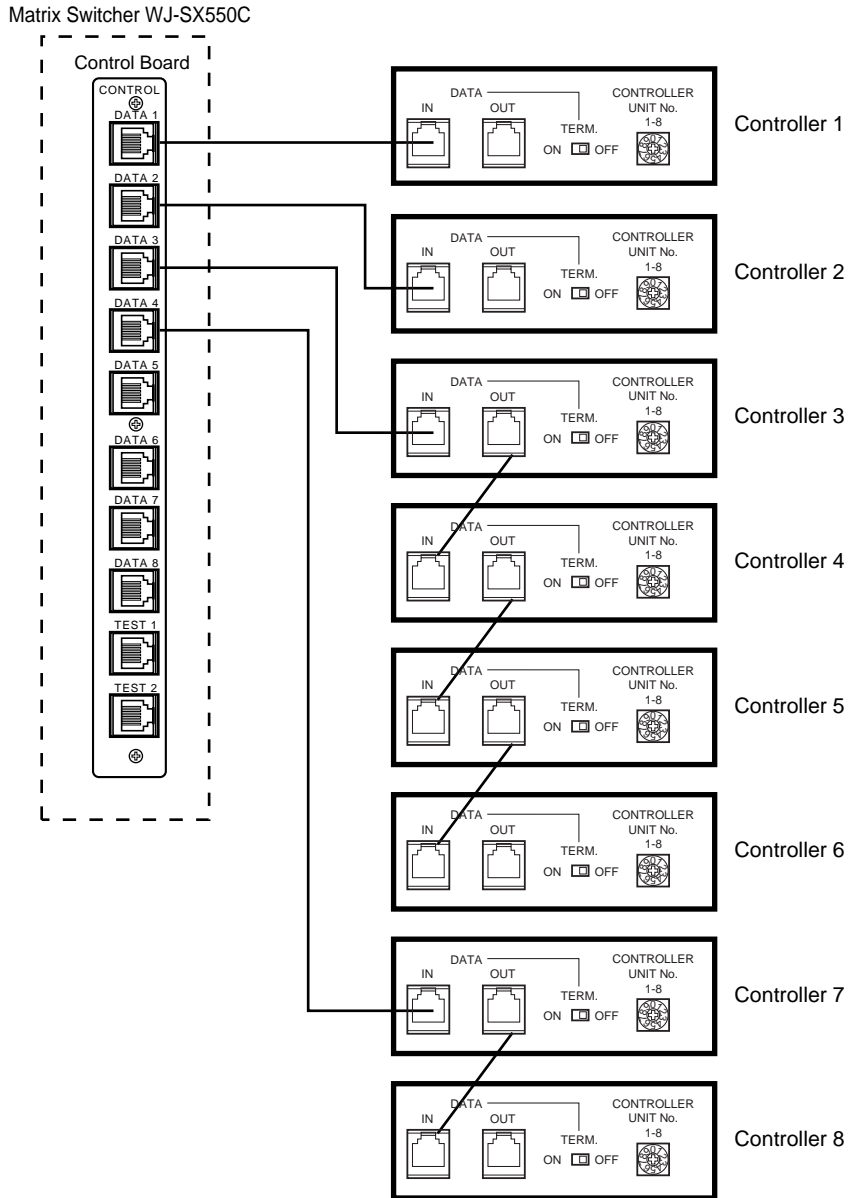

Combination Connections

Termination and Controller Unit Number Setting

	Termination Switch	Controller Unit Number	Controller Number on Status Monitor
Controller 1	ON	Any Number 1-8	1
Controller 2	ON	Any Number 1-8	2
Controller 3	OFF	1	3
Controller 4	OFF	2	3
Controller 5	OFF	3	3
Controller 6	ON	4	3
Controller 7	OFF	1	4
Controller 8	ON	2	4

Notes:

- Do not set “0” or “9” for controller unit numbers.
- The Controller number on the status monitor is determined by the Control Board port number.
- Confirm that the jumper connector (CN13) on the Control Board is positioned as shown below.

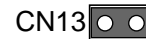

■ Connection with the Alarm Sensor Units

Connect the sensor switches to the Alarm Input Connector on the Alarm Board as shown in the example below.

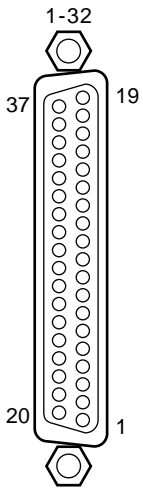
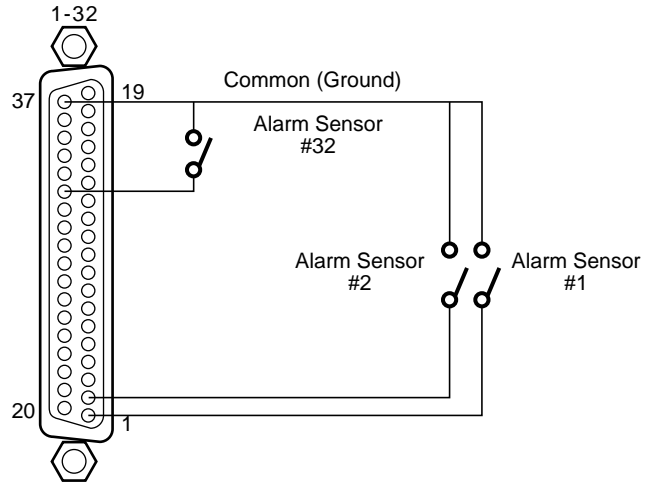

Pin No.	Designation		Pin No.	Designation	
	Board No.1	Board No.2		Board No.1	Board No.2
1	Alarm 1	Alarm 65	20	Alarm 20	Alarm 84
2	Alarm 2	Alarm 66	21	Alarm 21	Alarm 85
3	Alarm 3	Alarm 67	22	Alarm 22	Alarm 86
4	Alarm 4	Alarm 68	23	Alarm 23	Alarm 87
5	Alarm 5	Alarm 69	24	Alarm 24	Alarm 88
6	Alarm 6	Alarm 70	25	Alarm 25	Alarm 89
7	Alarm 7	Alarm 71	26	Alarm 26	Alarm 90
8	Alarm 8	Alarm 72	27	Alarm 27	Alarm 91
9	Alarm 9	Alarm 73	28	Alarm 28	Alarm 92
10	Alarm 10	Alarm 74	29	Alarm 29	Alarm 93
11	Alarm 11	Alarm 75	30	Alarm 30	Alarm 94
12	Alarm 12	Alarm 76	31	Alarm 31	Alarm 95
13	Alarm 13	Alarm 77	32	Alarm 32	Alarm 96
14	Alarm 14	Alarm 78	33	Not used	Not used
15	Alarm 15	Alarm 79	34	Not used	Not used
16	Alarm 16	Alarm 80	35	Not used	Not used
17	Alarm 17	Alarm 81	36	Ground	Ground
18	Alarm 18	Alarm 82	37	Ground	Ground
19	Alarm 19	Alarm 83			

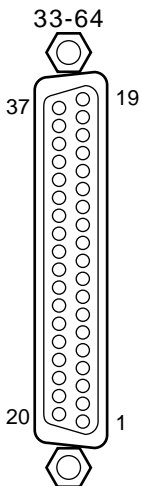

Pin No.	Designation		Pin No.	Designation	
	Board No.1	Board No.2		Board No.1	Board No.2
1	Alarm 33	Alarm 97	20	Alarm 52	Alarm 116
2	Alarm 34	Alarm 98	21	Alarm 53	Alarm 117
3	Alarm 35	Alarm 99	22	Alarm 54	Alarm 118
4	Alarm 36	Alarm 100	23	Alarm 55	Alarm 119
5	Alarm 37	Alarm 101	24	Alarm 56	Alarm 120
6	Alarm 38	Alarm 102	25	Alarm 57	Alarm 121
7	Alarm 39	Alarm 103	26	Alarm 58	Alarm 122
8	Alarm 40	Alarm 104	27	Alarm 59	Alarm 123
9	Alarm 41	Alarm 105	28	Alarm 60	Alarm 124
10	Alarm 42	Alarm 106	29	Alarm 61	Alarm 125
11	Alarm 43	Alarm 107	30	Alarm 62	Alarm 126
12	Alarm 44	Alarm 108	31	Alarm 63	Alarm 127
13	Alarm 45	Alarm 109	32	Alarm 64	Alarm 128
14	Alarm 46	Alarm 110	33	Not used	Not used
15	Alarm 47	Alarm 111	34	Not used	Not used
16	Alarm 48	Alarm 112	35	Not used	Not used
17	Alarm 49	Alarm 113	36	Ground	Ground
18	Alarm 50	Alarm 114	37	Ground	Ground
19	Alarm 51	Alarm 115			

■ Connection between the Data Board and Camera Site

Connect the Data Board and the Camera Controller (or specified camera) using the specified data cable. A basic connection is shown in the figure below.

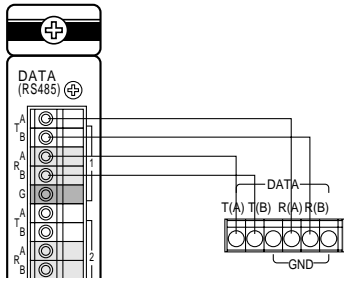

Then make the following settings on the Setup Menu of each component.

• Matrix Switcher

Set Up System RS-485

RS-485 Site Communication Board Addr. 1

Camera In Number	F/H Duplex	Delay Time	Baud Rate	Wait Time	Data Bit	Parity Check	Stop Bit
#1	02 Full	Off	19200	Off	8	None	1
#2	04 Half	Off	9600	Off	8	None	1
#3	06 Full	100	19200	Off	8	None	1
#4	Full	Off	19200	Off	8	None	1
#5	10 Full	Off	1200	Off	8	None	1
#6	Full	Off	19200	Off	8	None	1
#7	Full	Off	19200	Off	8	None	1
#8	Full	Off	19200	Off	8	None	1

When Daisy Mode is "on" only #1 will be available

F1:-- F2:-- F3:DEL F4:Pop Up

• Camera Controller

** Communication **

Unit Number 1
 Baud Rate 19200
 Data Bit 8
 Parity Check None
 Stop Bit 1
 Xon/Xoff Not Use
 Wait Time Off
 Delay Time Off
 Alarm Data Off
 Return

• Camera

** RS485 SET UP **

UNIT NUMBER 1
 SUB ADDRESS 1
 BAUD RATE 19200
 DATA BIT 8
 PARITY CHECK NONE
 STOP BIT 1
 XON/XOFF NOT USE
 WAIT TIME OFF
 ALARM DATA AUTO2
 DELAY TIME OFF
 RET

● Direct Connection between the Data Board and Camera Controllers

In this type of connection there is one data cable directly connecting each Data Connector to the WV-RM70 Camera Controller (or specified camera). Refer to the connections and settings shown below.

4-Line (Full Duplex) Connection

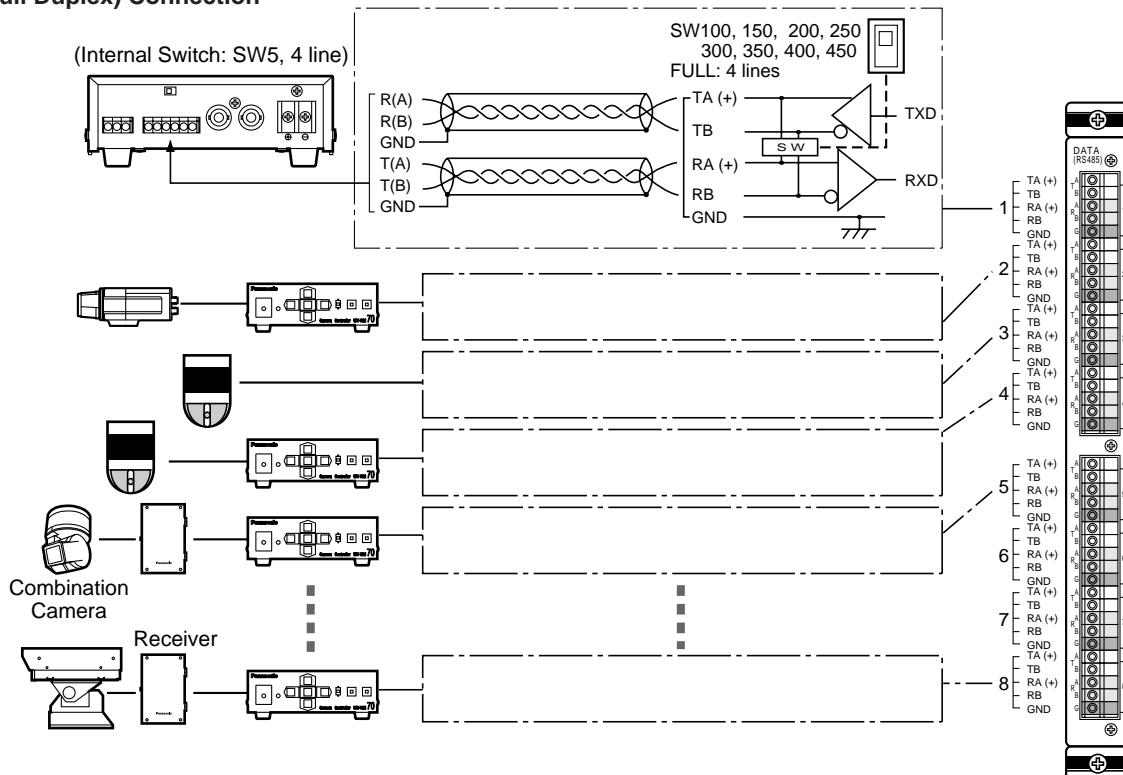

2-Line (Half Duplex) Connection

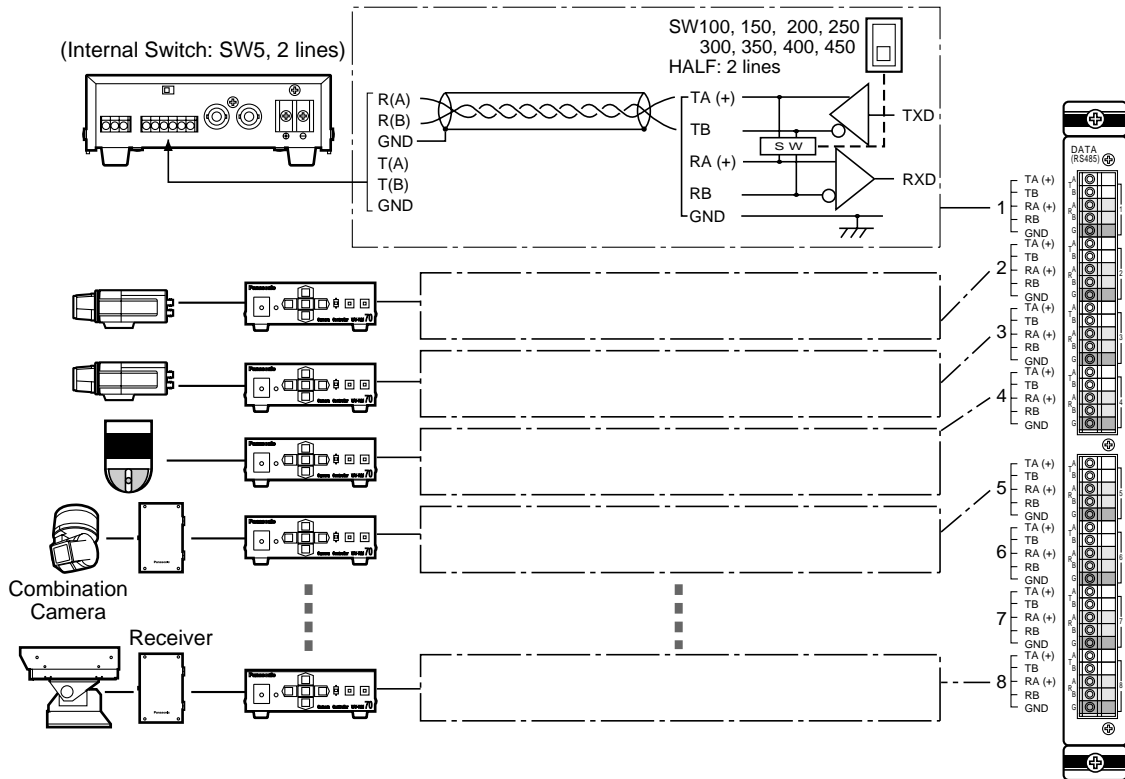

Note: In the above connection the camera power must be turned on in order for the Camera Status Display described on page 111 to be displayed correctly.

Set the Matrix Switcher and the Camera Controllers (up to 8) as shown below.

Parameters	Models	Matrix Switcher WJ-SX550C	Camera Controller WV-RM70
Daisy	: On	F/H Duplex : Full	
		Camera In Number #1 - - -	Unit Number: 1
		Camera In Number #2 - - -	Unit Number: 2
		Camera In Number #3 - - -	Unit Number: 3
		Camera In Number #4 - - -	Unit Number: 4
		Camera In Number #5 - - -	Unit Number: 5
		Camera In Number #6 - - -	Unit Number: 6
		Camera In Number #7 - - -	Unit Number: 7
		Camera In Number #8 - - -	Unit Number: 8

Caution

Only one unit in a daisy chain is available for receiving alarm data. Set the Mode Selection Switch on one Camera Controller to "NORMAL" position and on the others to "ALARM OFF" position.

Note: 2-line (Half Duplex) connection is not available in a daisy chain.

SECTION 4
SOFTWARE
SETUP

SETUP MENU

The Setup Menu provides a way for controlling functions that are not available by a direct operation. Access to the Setup Menu is limited to operators with the proper operator's level.

● Access to the Setup Menu

1. System Log-in
Refer to Log-in on page 95 for details.
2. Select the desired monitor for viewing the Setup Menu.
Refer to Monitor Selection on page 98.
3. Select the Set Up Menu (**A6**) on the LCD display by pressing the Direction buttons (◀ ▶ ▲ ▼).

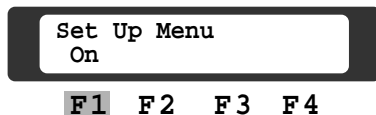

4. Press the Function **F1** button to allow access to the Setup Programming Menu (Set Up Menu).
The menu now appears on the active monitor.

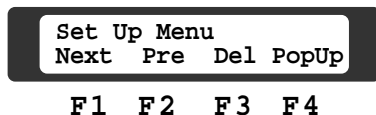

Note: The Setup Menu is initially set to the default values.

It can be programmed to limit access to certain operator levels.

If the Setup Menu does not appear on the active monitor and "PROHIBITED" appears on the LCD display, press the **MON (ESC)** key to return to the previous Set Up Menu display.

The following buttons and keys are valid In the Setup Menu:

Function buttons

- F1:** Selects the next page.
- F2:** Selects the previous page.
- F3:** Deletes or initializes the setting where the cursor is positioned.
- F4:** Opens the Pop Up Window.



Executes the setting or selection.



Escapes from the programming mode or menu.

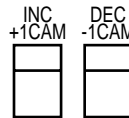

Performs various functions, depending on the selected menu

● Access to the Printer Menu

1. Press the Direction (▼) button to access the menu on the LCD display as shown below.

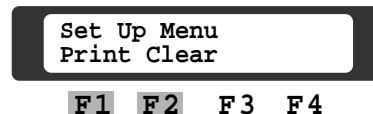

2. Press the Function **F1** button to open the Pop Up Window, and then select the desired print out mode by moving the Joystick Controller.

Press the **CAM (SET)** key to start printing out the selected setup data.

Press the **MON (ESC)** key to stop printing.

To Clear all data from a table:

1. Press the Function **F2** button to open the Pop Up Window.

Select "Yes" by moving the Joystick Controller, and then pressing the **CAM (SET)** key to delete all data from the selected programmed table.

■ Setup Programming Menu

As shown below, the Setup Menu has six main submenus: Program, Operator, Camera Title, Alarm Recall, Status and System. Three of these, Program, Operator and System, are further divided into additional submenus.

Setup		
Program	Program Sequence	Page 67
	Tour Sequence	Page 68
	Group Sequence	Page 69
	Timer	Event Schedule Page 71
		Special Day Schedule Page 72
	Alarm	Alarm Mode Select Page 74
		Set Up Alarm Mode 1 Page 75
		Set Up Alarm Mode 2 Page 76
		Set Up Alarm Mode 3 Page 77
		Timer Alarm Schedule Page 79
Operator	Level Table	Page 80
	Operator Registration	Page 81
Camera Title		Page 82
Alarm Recall		Page 83
Status		Page 83
System	Controller	Page 84
	EXT Timing Select	Page 85
	Compensation/VD2	Page 86
	RS-485 Site Communication	Page 87
	Communication Speed	Page 88
	Clock	Page 89
Auto Cleaning		Page 90

■ Setup Menu

After having selected [Setup Menu On] on the LCD display, the interactive online Setup Menu allows access to six main items as shown below.

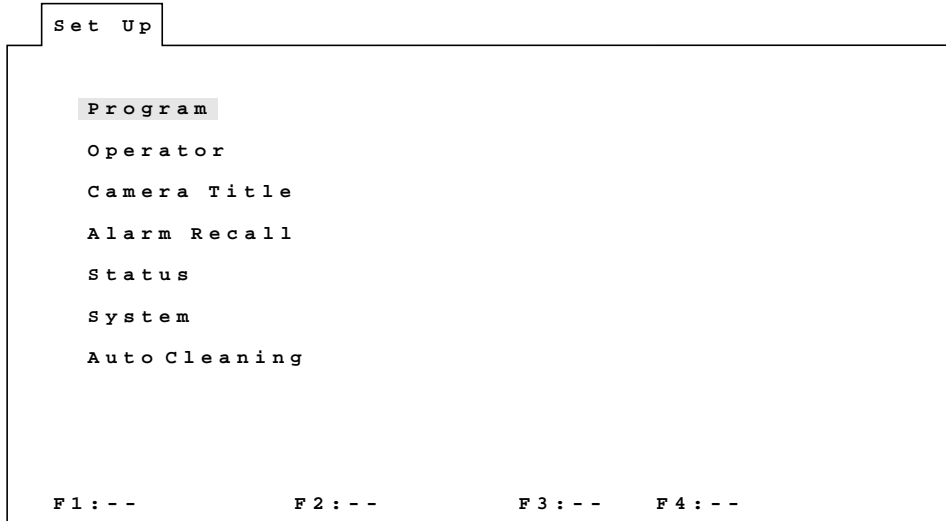

To Select an item from the **Set Up Menu**:

1. Move the cursor to the desired item by moving the Joystick Controller.
2. To execute the selection, press the **CAM (SET)** key. The selected item appears on the monitor.
3. To escape from the menu without changing any settings, press the **MON (ESC)** key.

4

■ Program (PROG.) Menu

Select Program on the Setup Menu by moving the Joystick Controller, then press the **CAM (SET)** key to display the Program (PROG.) Menu as shown below.

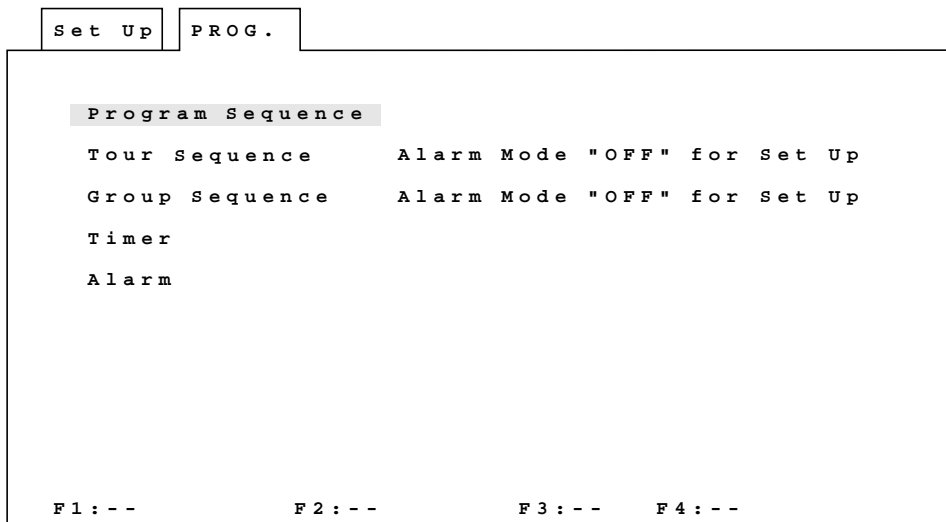

To select an item from the **Program (PROG.) Menu**:

1. Move the cursor to the desired item by moving the Joystick Controller.
2. To execute the selection, press the **CAM (SET)** key. The selected item appears on the monitor.
3. To return to the Setup Menu, press the **MON (ESC)** key.

● Program Sequence (P-SEQ)

This table is used to program or edit a Program Sequence.

A Program Sequence is a series of 64 steps assigned to a particular monitor.

Each step has a camera number assigned to it.

The Program Sequence number refers to the actual monitor that a sequence is assigned to.

In the table below, the sequence is assigned to monitor #1.

This table also has an Auto Skip function, which, when selected on, will automatically skip any step if there is no video signal present at that step. The duration in time of each step is determined by the Dwell Time setting.

Program Sequence M01																
Auto Skip				Dwell												
off				02 sec												
Step	01	02	03	04	05	06	07	08	09	10	11	12	13	14	15	16
CAM	01	10	27	43	21	60	33	09	18	25	42	39	03	22	50	41
Step	17	18	19	20	21	22	23	24	25	26	27	28	29	30	31	32
CAM	53	20	12	07	00											
Step	33	34	35	36	37	38	39	40	41	42	43	44	45	46	47	48
CAM																
Step	49	50	51	52	53	54	55	56	57	58	59	60	61	62	63	64
CAM																

F1: -- F2: -- F3: DEL F4: Pop Up

4

To program or edit a Program Sequence, do the following:

1. Move the cursor to position 3 by moving the Joystick controller.
Enter the desired sequence number (1-16) by pressing the Numeric keys, and then press the **CAM (SET)** key to execute the selection.
2. Move the cursor to position 4 by moving the Joystick controller.
Press the Function **F4** button to open the Pop Up Window.
Select Auto Skip On or Off by moving the Joystick Controller, and then press the **CAM (SET)** key to execute the selection.
3. Move the cursor to position 5 by moving the Joystick Controller.
Enter the desired Dwell Time (1-30) by pressing the Numeric keys.
4. Move the cursor to position 6 by moving the Joystick Controller.
Enter the desired camera number (1-128) for each step by pressing the Numeric keys.
5. When satisfied with all of the above steps, press the **MON (ESC)** key to escape from the programming mode.
The cursor returns to position 3.
6. Repeat the above procedures to program the other monitor program sequences.

● Tour Sequence (T-SEQ)

This table is used to program or edit a Tour Sequence.

There are 32 Tour Sequences available, each with 64 steps.

Each step has a camera number (CAM), an associated Pan/Tilt preset position (PRE), a dwell time (DWELL), and AUX 1 and AUX 2 control assigned to it.

No monitor number is assignable in the Tour Sequence. The sequence will run on any monitor that the user can control.

Step	01	02	03	04	05	06	07	08	09	10	11	12	13	14	15	16
CAM	10	15	09	00	04	00	00	00	00	00	00	00	00	00	00	00
PRE		20	64	11	09											
DWELL	03	00	01	02	05	00	00	00	00	00	00	00	00	00	00	00
AUX1			<input type="checkbox"/>													
AUX2				-												

Step	17	18	19	20	21	22	23	24	25	26	27	28	29	30	31	32
CAM	00	00	00	00	00	00	00	00	00	00	00	00	00	00	00	00
PRE																
DWELL	00	00	00	00	00	00	00	00	00	00	00	00	00	00	00	00
AUX1																
AUX2																

. . On . . Off
 F1: Next Page F2: Pre Page F3: DEL F4: Pop Up

4

To program or edit a Tour Sequence, do the following:

Caution: Before programming or editing a Tour Sequence, the Alarm Mode must be in the Off mode first. Follow Alarm Mode Select procedures on page 74.

1. Move the cursor to position 3 by moving the Joystick Controller. Enter the desired tour sequence number (1-32) by pressing the Numeric keys, and then pressing the **CAM (SET)** key to execute the selection.
2. Move the cursor to position 4 by moving the Joystick Controller. Press the Function **F4** button to open the Pop Up Window. Select Auto Skip On or Off by moving the Joystick Controller, and then press the **CAM (SET)** key to execute the selection.
3. Move the cursor to position 5 by moving the Joystick Controller. Enter the desired camera number (1-128) for each step by pressing the Numeric keys.
4. Move the cursor to position 6 by moving the Joystick Controller. Enter the associated Pan/Tilt preset position number (if applicable) by pressing the Numeric keys.
5. Move the cursor to position 7 by moving the Joystick Controller. Enter the desired Dwell Time (1-30) by pressing the Numeric keys.
6. Move the cursor to position 8 or 9 by moving the Joystick Controller. Press the Function **F4** button to open the Pop Up Window. Select AUX On or Off by moving the Joystick Controller, and then press the **CAM (SET)** key to execute the selection.
7. Press the function **F1** button to select the next page or press the Function **F2** button to select the previous page. Repeat the above procedures until a tour sequence is completely assembled.
8. When satisfied with all of the above steps, press the **MON (ESC)** key to escape from the programming mode. The cursor returns to position 3.
9. Repeat the above procedures to program the other Tour Sequences.

● Group Sequence (G-SEQ)

This table is used to program or edit a Group Sequence.

A Group Sequence consists of up to 64 steps. In each step, a maximum of 16 cameras can be assigned to 16 monitors, each with preset position (if applicable) and AUX 1 and AUX 2 control.

There are 8 Group Sequences available in this system.

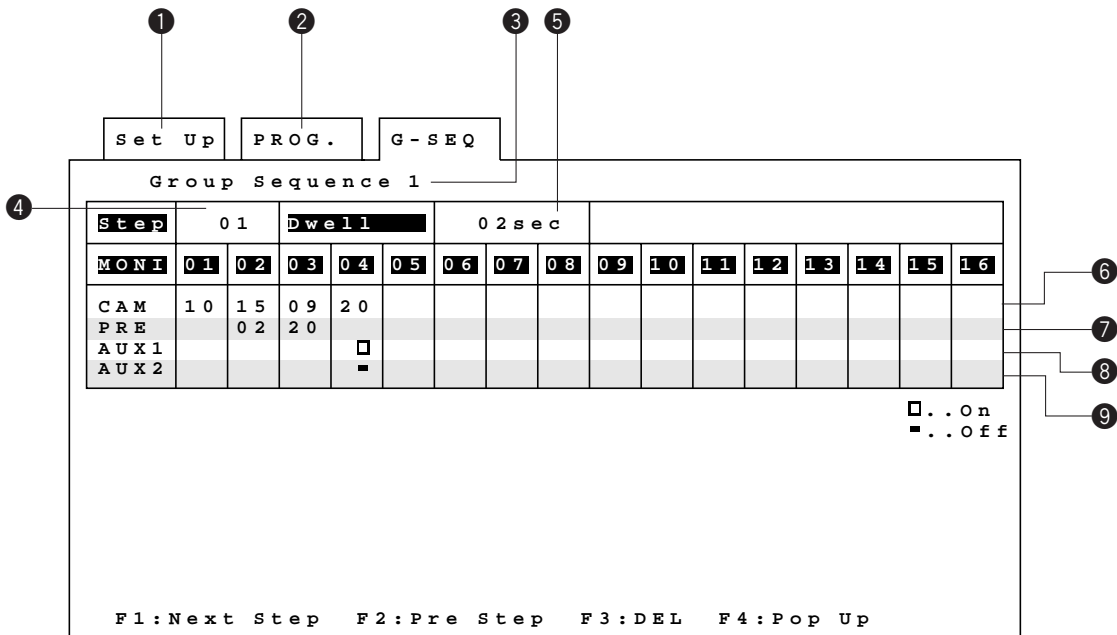

4

To program or edit a Group Sequence, do the following:

Caution: Before programming or editing a Group Sequence, the Alarm Mode must be in the Off mode first. Follow Alarm Mode Select procedures on page 74.

1. Move the cursor to position 3 by moving the Joystick Controller. Enter the desired Group Sequence number (1-8) by pressing the Numeric keys, and then press the **CAM (SET)** key to execute the selection.
2. Confirm that the desired step number is indicated.
If not, move the cursor to position 4 by moving the Joystick controller, then enter the desired step number (1-64) by pressing the Numeric keys.
3. Move the cursor to position 5 by moving the Joystick Controller.
Enter the desired Dwell Time (1-30) by pressing the Numeric keys.
4. Move the cursor to position 6 by moving the Joystick Controller.
Enter the desired camera number (1-128) by pressing the Numeric keys.
5. Move the cursor to position 7 by moving the Joystick Controller.
Enter the associated pan / tilt preset position number (if applicable) by pressing the Numeric keys.
6. Move the cursor to position 8 or 9 by moving the Joystick Controller.
Press the Function **F4** button to open the Pop Up Window.
Select AUX On or Off by moving the Joystick Controller, and then press the **CAM (SET)** key to execute the selection.
7. Press the Function **F1** button to select the next step.
Repeat the above procedures until the Group Sequence is completely assembled.
8. To select the previous step, press the Function **F2** button.
9. When satisfied with all of the above steps, press the **MON (ESC)** key to escape from the programming mode.
The cursor returns to position 3.
10. Repeat the above procedures to program the other Group Sequences.

● Timer Menu

As shown below, the Timer Menu allows access to two items, Event and Special Day Schedule.

With these two items, it is possible to enable or disable Tour and Group Sequences on selected monitors based on time of day, day of the week, and user-definable special days.

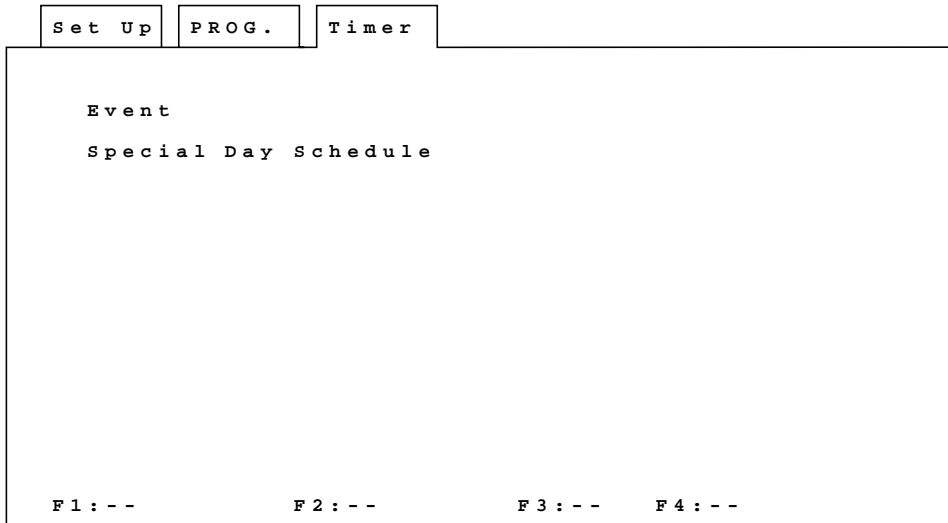

To select an item from the **Timer Menu**:

1. Move the cursor to the desired item by moving the Joystick Controller.
2. To execute the selection, press the **CAM (SET)** key. The selected item appears on the monitor.
3. To return to the Program Menu, press the **MON (ESC)** key.

● Event Menu

Selecting the Event Menu allows access to the twelve items in the figure shown below.

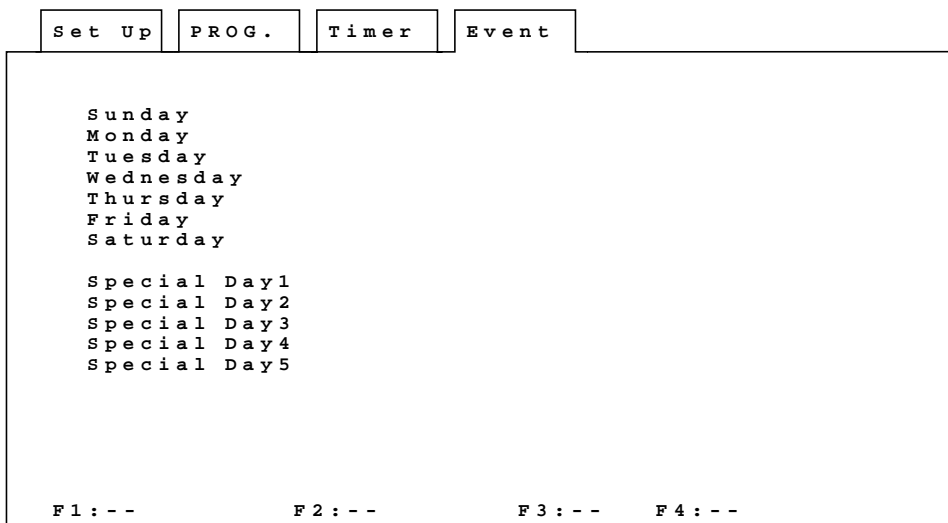

To select an item from the **Event Menu**:

1. Move the cursor the desired item by moving the Joystick Controller.
2. To execute the selection, press the **CAM (SET)** key. The selected item appears on the monitor.
3. To return to the Timer Menu, press the **MON (ESC)** key.

● Timer Event Schedule

This table is used to enable and disable Tour and Group Sequences according to the time of day and day of the week. There are 45 events available in one day.

Start	Stop	<	M1	M2	M3	M4	M5	M6	M7	M8	M9	>
00:00	01:00		T 6 4			T 0 1			T 0 1			
00:30	09:00											
10:00	10:10			T 1 7								
10:10	10:50		G 1	G 1	G 1	G 1		T 3 6				
11:00	11:30						T 0 1		T 3 2			
11:00	11:40											
11:30	11:50											
11:50	12:00									G 3	G 3	
12:00	12:30											
12:30	13:31							T 0 8				
13:30	14:30								T 1 1			
15:00	16:00				T 2 1							
16:00	17:00											
17:00	17:30							T 4 3				
17:30	19:00									T 5 2		

F1: Next Page F2: Pre Page F3: DEL F4: Pop Up

T..Tour G..Group

4

To program or edit a Timer Event Schedule, do the following:

1. Move the cursor to position 5 by moving the Joystick Controller, and then press the **CAM (SET)** key to execute the selection.
2. Move the cursor to position 6, 7, 8 and 9 by moving the Joystick Controller.
Enter the desired hours (24-hour military time) or minutes by pressing the Numeric keys.
3. Move the cursor to position 11 by moving the Joystick Controller.
Press the Function **F4** button to open the Pop Up Window.
Select the desired sequence type by moving the Joystick Controller, and then enter the sequence number by pressing the Numeric keys.
Press the **CAM (SET)** key to execute the selection.
Note: The table (position 11) can only display nine monitors selection table.
4. Move the cursor to position 12 by moving the Joystick Controller.
By pressing the **CAM (SET)** key repeatedly, access to higher number monitors is possible.
5. Move the cursor to position 10 by moving the Joystick Controller.
By pressing the **CAM (SET)** key repeatedly, access to lower number monitors is possible.
6. When satisfied with the programming of events on this page, press the Function **F1** button to select the next page.
Repeat the above procedures until all events are programmed.
Note: There is a total of 45 events available for a day and each page holds 15 events, so there is a total of 3 pages available for each day.
7. Press the Function **F2** button to go back to the previous page.
8. When satisfied with all events, press the **MON (ESC)** key to escape from the programming mode.
The programmed events are automatically placed in chronological order and the cursor returns to position 5.
9. Similarly, repeat the above procedures to program other days.

Notes:

- When programming a timer event that extends into the next day, divide the timer event into two separate events and program both events separately.

For example,

Day	Start	Stop
Monday	23:00	24:00
Tuesday	0:00	7:00

- A timer activated sequence will be continued until the next automatic or manual operation is performed.

● Special Day Schedule

Before programming this table, confirm that the Timer Event Schedule (Special Day 1-5) is programmed completely. This table allows for up to 48 days to be defined as special days. In the Timer Event Schedule, there are 5 tables where the special days 1 through 5 are programmed for sequences. In this table, 48 specific, user defined, days of the year are assigned to one of those 5 special days.

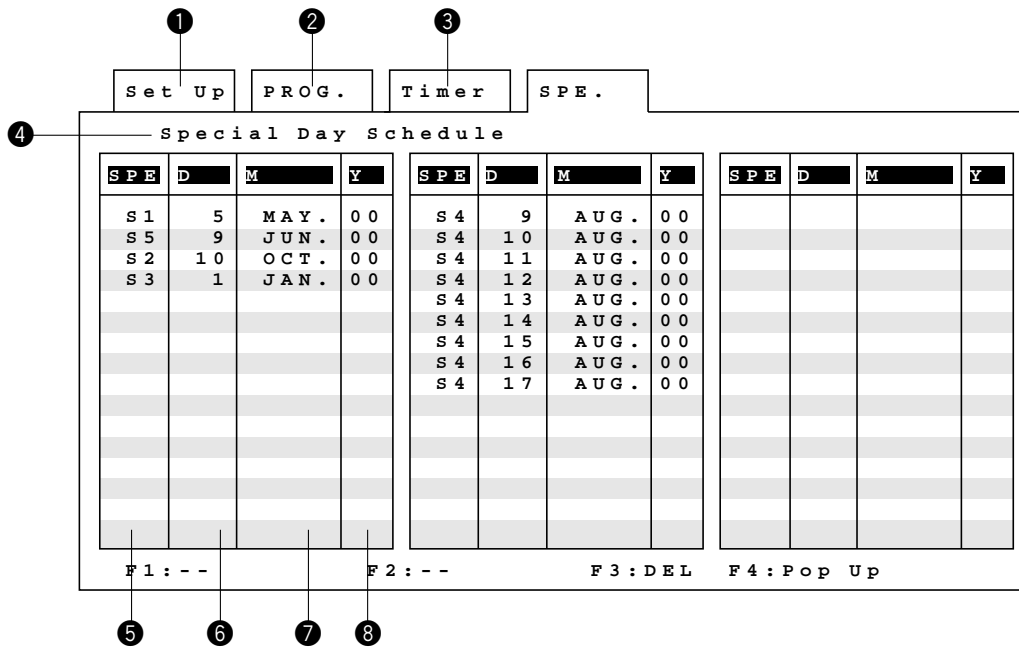

4

To program or edit a Special Day Schedule, do the following:

1. Move the cursor to position 4 by moving the Joystick Controller, then press the **CAM (SET)** key to execute the selection.
2. Move the cursor to position 5 by moving the Joystick Controller. Press the Function **F4** button to open the Pop Up Window. Select the desired special day (S1-S5) by moving the Joystick Controller, and then press the **CAM (SET)** key to execute the selection.
3. Move the cursor to position 6 by moving the Joystick Controller. Enter the desired date by pressing the Numeric keys.
4. Move the cursor to position 7 by moving the Joystick Controller. Press the Function **F4** button to open the Pop Up Window. Select the desired month by moving the Joystick Controller, and then press the **CAM (SET)** key to execute the selection.
5. Move the cursor to position 8 by moving the Joystick Controller. Enter the desired year (last two digits) by pressing the Numeric keys.
Note: Valid dates are between the year 2000 and the year 2093.
 Enter "00" for the year 2000.
6. After completing all schedules, press the **MON (ESC)** key to escape from the programming mode. The cursor returns to position 4.

Note: When programming the above table be sure that month, date and year are all entered. Otherwise, if an item is not entered, the schedule will be activated as shown below.

SPE	D	M	Y	Activate
S1	24	DEC.	-	24th Dec. of every year
S2	-	-	00	Everyday of 2000

Also, if there is an overlap of dates in the schedule, like the one shown here, the upper left most item is given precedence. In this example S1 is activated.

● Alarm Menu

As shown below, the Alarm Menu allows access to five items: Alarm Mode Select, Set Up Alarm Modes 1-3 and Timer Alarm Schedule.

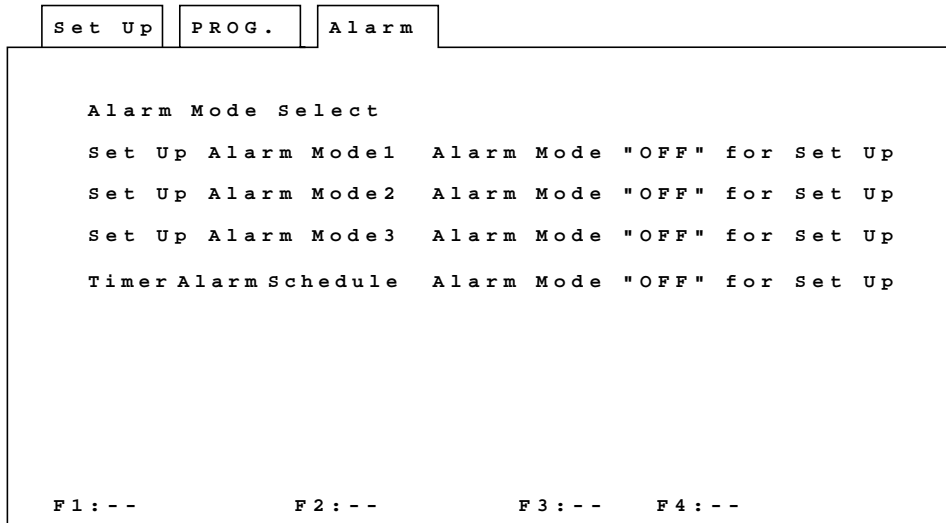

To select an item from the **Alarm Menu**:

1. Select the desired item by moving the Joystick Controller.
2. To execute the selection, press the **CAM (SET)** key. The selected item appears on the monitor.
3. To return to the Program Menu, press the **MON (ESC)** key.

● Alarm Mode Select

There are 5 Alarm modes available: Mode-1, Mode-2, Mode-3, Off mode and Timer mode.

In Alarm mode-1, all alarm inputs are displayed in sequential order on monitor 1.

In Alarm mode-2, all alarm inputs are displayed in sequential order on monitors 1 through 4.

In Alarm mode-3, any alarm input can be displayed on any monitor, along with presets (if applicable) and Auxiliary 1 and 2 control.

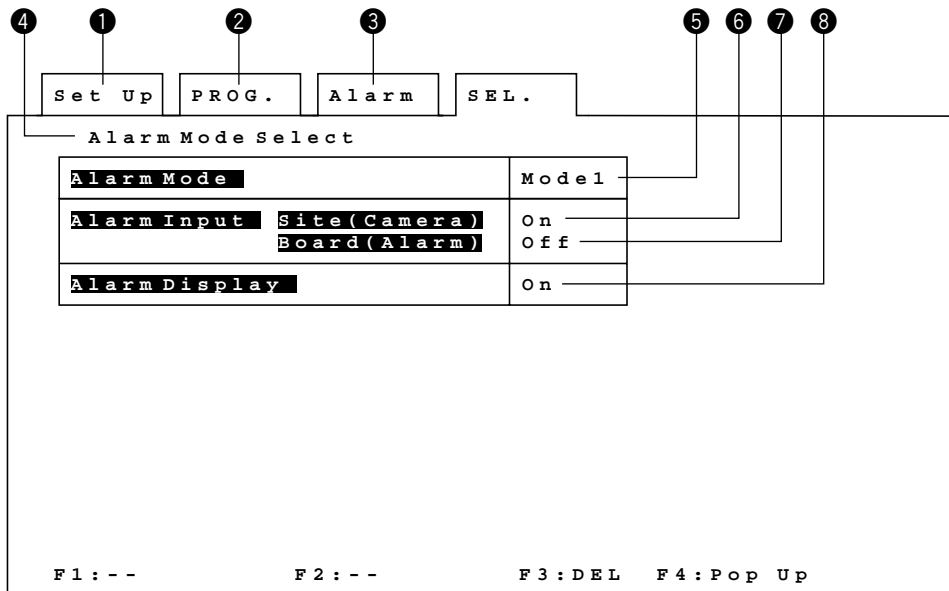

4

To program or edit an Alarm Mode Select, do the following:

1. Move the cursor to position 4 by moving the Joystick Controller, then press the **CAM (SET)** key to execute the selection.
2. Move the cursor to position 5 by moving the Joystick Controller.
Press the Function **F4** button to open the Pop Up Window.
Select the desired alarm mode by moving the Joystick Controller, and then press the **CAM (SET)** key to execute the selection.
3. Move the cursor to position 6 by moving the Joystick Controller.
Press the Function **F4** button to open the Pop Up Window.
Select camera site alarm input On or Off by moving the Joystick Controller, and then press the **CAM (SET)** key to execute the selection.
4. Move the cursor to position 7 by moving the Joystick Controller.
Press the Function **F4** button to open the Pop Up Window.
Select alarm board input On or Off by moving the Joystick Controller, and then press the **CAM (SET)** key to execute the selection.
5. Move the cursor to position 8 by moving the Joystick Controller.
Press the Function **F4** button to open the Pop Up Window.
Select alarm display On or Off on the monitor by moving the Joystick Controller, and then press the **CAM (SET)** key to execute the selection.
6. Press the **MON (ESC)** key to escape from the programming mode.
The cursor returns to position 4.

● Set Up Alarm Mode 1

Note: To be able to set up this table, the Alarm Mode on the Alarm Mode Select table must be set to Off.

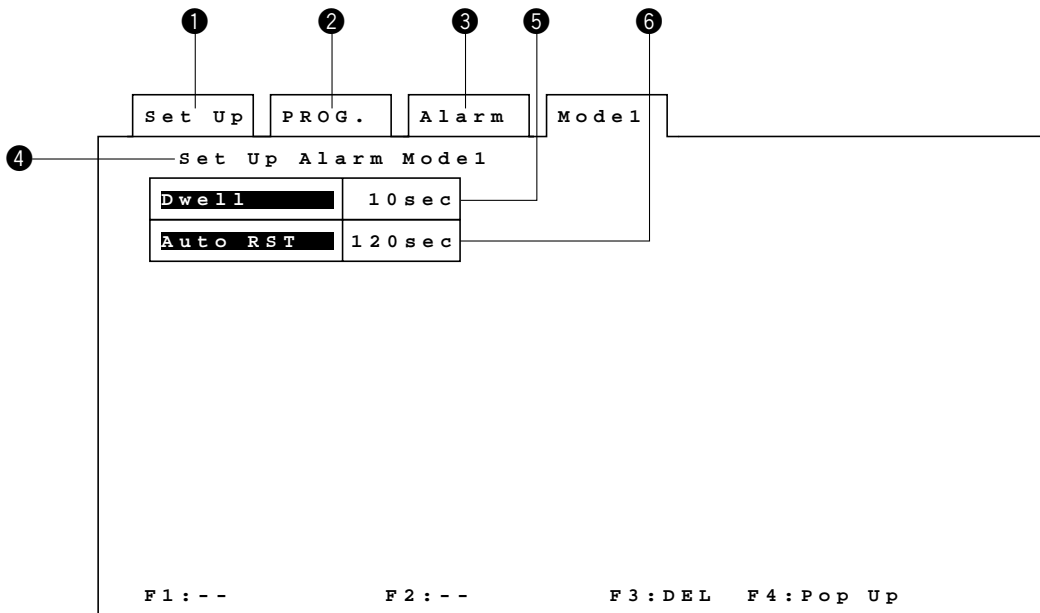

To program or edit an Alarm Mode 1, do the following:

1. Move the cursor to position 4 by moving the Joystick Controller, then press the **CAM (SET)** key to execute the selection.
2. Move the cursor to position 5 by moving the Joystick Controller.
Enter the desired dwell time (1-30) by pressing the Numeric keys.
3. Move the cursor to position 6 by moving the Joystick Controller, then press the Function **F4** button to open the Pop Up Window.
Move the cursor with the Joystick Controller to the desired Auto Reset time (30, 60, 90, 120, 150, 180, Off) in the Pop Up Window, and then press the **CAM (SET)** key to execute the selection.
4. To select an Auto Reset time other than those displayed in the Pop Up Window in 1-second increments or decrements between 1 to 60 seconds, leave the cursor on 30 or 60 and press the **INC +1CAM** or **DEC -1CAM** button.
57 ← 58 ← 59 ← **60** → 90 → 120 → 150 → 180 → Off
27 ← 28 ← 29 ← **30** → 31 → 32 → 33....
5. Press the **MON (ESC)** key to escape from the programming mode. The cursor returns to position 4.

● Set Up Alarm Mode 2

Note: To be able to set up this table, the Alarm Mode on the Alarm Mode Select table must be set to Off.

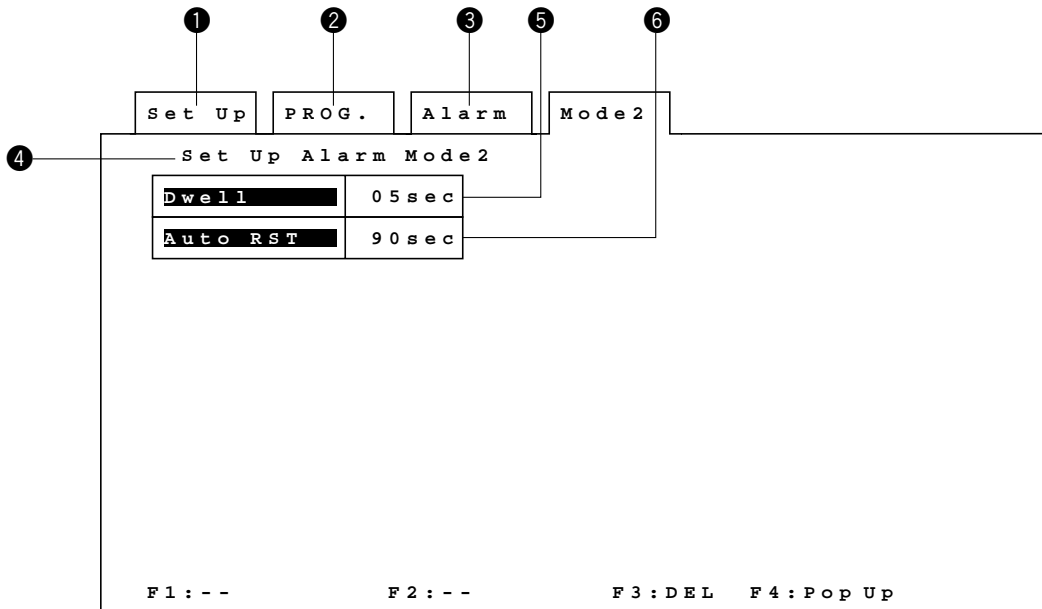

To program or edit an Alarm Mode 2, do the following:

1. Move the cursor to position 4 by moving the Joystick Controller, then press the **CAM (SET)** key to execute the selection.
2. Move the cursor to position 5 by moving the Joystick Controller.
Enter the desired dwell time (1-30) by pressing the Numeric keys.
3. Move the cursor to position 6 by moving the Joystick Controller, then press the Function **F4** button to open the Pop Up Window.
Move the cursor with the Joystick Controller to the desired Auto Reset time (30, 60, 90, 120, 150, 180, Off) in the Pop Up Window, and then press the **CAM (SET)** key to execute the selection.
4. To select an Auto Reset time other than those displayed in the Pop Up Window in 1-second increments or decrements between 1 to 60 seconds, leave the cursor on 30 or 60 and press the **INC +1CAM** or **DEC -1CAM** button.
57 ← 58 ← 59 ← **60** → 90 → 120 → 150 → 180 → Off
27 ← 28 ← 29 ← **30** → 31 → 32 → 33....
5. Press the **MON (ESC)** key to escape from the programming mode. The cursor returns to position 4.

[Explanation of Table]

The setup examples in the table on the preceding page are explained below.

● Example 1: Spot (S)

An alarm will cause the picture of the alarmed camera to be displayed on the designated monitor.

Contents of Example 1 setup:

When Alarm 1 is activated, Monitor 1 displays the picture of Camera 1 at preset position 1.

When a second alarm, Alarm 2, is activated, Monitor 1 switches to the picture of Camera 2, and after 5 seconds again switches to the picture of Camera 1 for 10 seconds. After that Monitor 1 displays the two camera pictures alternately.

Notes:

- If plural Spot Cameras are assigned to a monitor in the event of alarm, it is recommended to program a Tour Sequence in advance.
- To keep the latest alarmed Spot picture on a monitor, do the following:
 1. Set both the Dwell time and Auto Reset time to 30 seconds.
When several alarms are activated within a short period of time, the previous Spot picture may momentarily appear on the monitor.
 2. Make the Auto Reset time shorter than the Dwell time.
If the Auto Reset time expires before the next alarm is activated, the alarm mode will be reset and the Sequence or Spot picture displayed in response to the previous alarm remains on the monitor.

● Example 2: Tour Sequence (T)

An alarm will activate a previously programmed Tour Sequence on the designated monitor.

Contents of Example 2 setup:

When Alarm 3 is activated, Tour Sequence 1 runs on Monitor 2.

● Example 3: Group Sequence (G)

An alarm will activate a previously programmed Group Sequence on the designated monitor.

Contents of Example 3 setup:

When Alarm 4 is activated, Group Sequence 1 runs on Monitors 3 and 4.

Important:

Group Sequences must be assigned to monitors before programming the Setup menu.

● Example 4: Combination of all of the above

An alarm will activate a combination of the above previously programmed functions.

Contents of Example 4 setup:

When Alarm 5 is activated, Monitor 5 display the picture of Camera 3 at preset position 2. At the same time, Tour Sequence 2 runs on Monitor 2 and Group Sequence 2 runs on Monitors 7 and 8.

● Error (E) display

An attempt to assign an incompatible mode to a monitor will cause "E" for Error to be displayed in the table.

Example 5: Error (E)

An attempt was made to assign Tour Sequence 3 to Monitor 9, although Monitor 9 is designated as a Spot monitor.

Example 6: Error (E)

An attempt was made to assign more than one sequence to one monitor. In this case, the first assignment is valid and all subsequent ones are invalid.

● Timer Alarm Schedule

This table is used to enable and disable the Alarm Modes according to the time of day and day of the week.

Note: To be able to set up this table, the Alarm Mode on the Alarm Mode Select table must be set to Off.

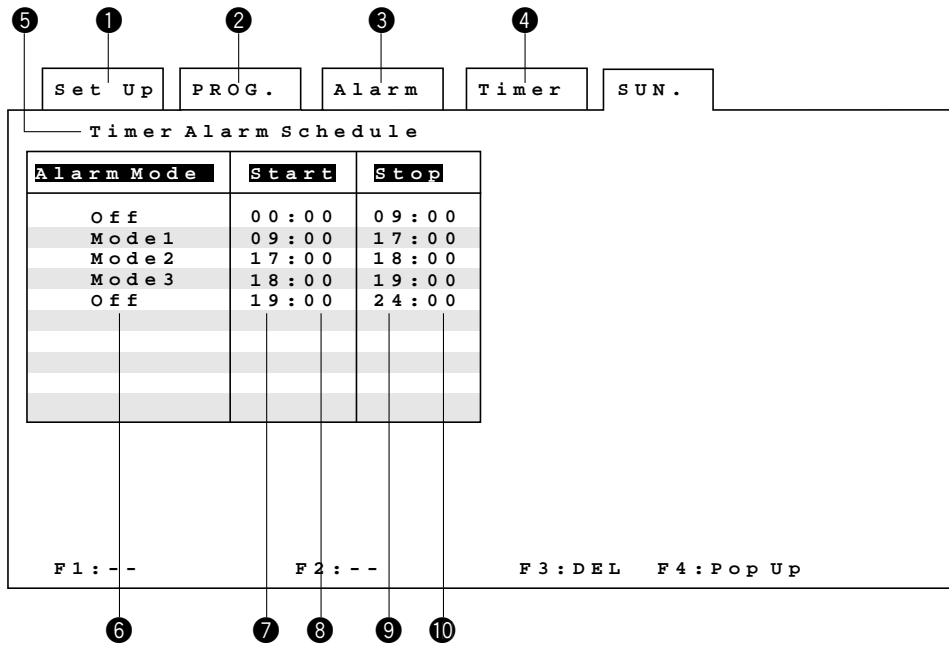

4

To program or edit a Timer Alarm Schedule, do the following:

1. Move the cursor to the desired item (Day or Special Day) by moving the Joystick Controller, then press the **CAM (SET)** key to execute the selection.
The selected item appears on the monitor.
2. Move the cursor to position 5 by moving the Joystick Controller, and then press the **CAM (SET)** key to execute the selection.
3. Move the cursor to position 6 by moving the Joystick Controller.
Press the Function **F4** button to open the Pop Up Window.
Select the desired alarm mode by moving the Joystick Controller, then press the **CAM (SET)** key execute the selection.
4. Move the cursor to position 7, 8, 9 or 10 by moving the Joystick Controller.
Enter the desired hours (24-hour military time) or minutes by pressing the Numeric keys.
5. When satisfied with all alarms, press the **MON (ESC)** key to escape from the programming mode.
Programmed alarms are displayed in chronological order and the cursor returns to position 5.
6. Similarly, repeat the above procedures to program other days and special days.

Note: When programming a timer alarm that extends into the next day, divide the timer alarm into two separate alarms and program both alarms separately.

For example,

Day	Alarm Mode	Start	Stop
Monday	Off	23:00	24:00
Tuesday	Off	0:00	7:00

Caution: An alarm table programmed for special days 1 - 5 will be activated on the date programmed on the Special Days Schedule.

Refer to the Special Days Schedule on page 72.

■ Operator Menu

The operator menu allows access to two items: the level table and operator registration.

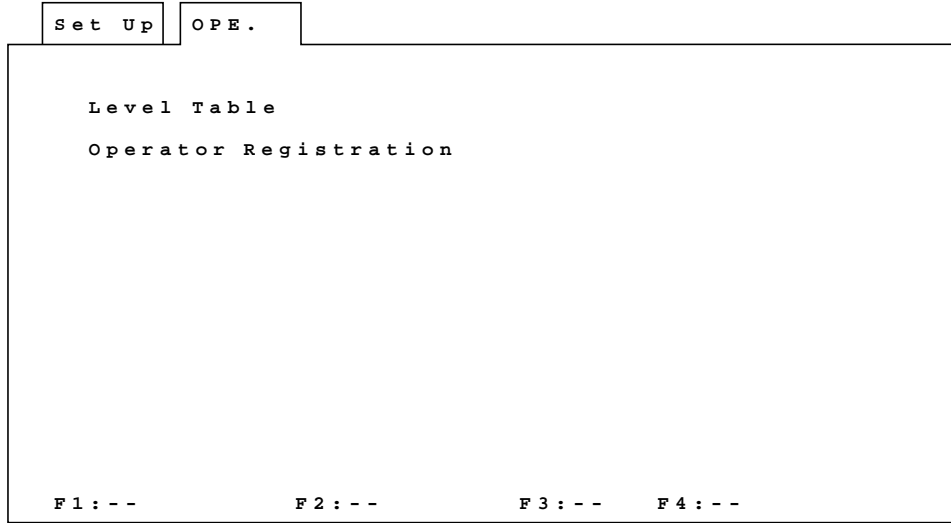

To select an item from the **Operator Menu**:

1. Select the desired item by moving the Joystick Controller.
2. To execute the selection, press the **CAM (SET)** key.
The selected menu appears on the monitor.
3. To return to the Set Up Menu, press the **MON (ESC)** key.

● Level Table

This table is used to determine what setup functions and operations may be performed by the 5 operator levels. There is a total of 23 functions or operation items available in the table.

Set Up	1	2	3	4	5	Operation	1	2	3	4	5
Set Up Menu	<input type="checkbox"/>	<input type="checkbox"/>	<input type="checkbox"/>	<input type="checkbox"/>	<input type="checkbox"/>	Camera Set Up	<input type="checkbox"/>	<input type="checkbox"/>	<input type="checkbox"/>	<input type="checkbox"/>	<input type="checkbox"/>
P-SEQ	<input type="checkbox"/>	<input type="checkbox"/>	<input type="checkbox"/>	<input type="checkbox"/>	<input type="checkbox"/>	CAM Select	<input type="checkbox"/>	<input type="checkbox"/>	<input type="checkbox"/>	<input type="checkbox"/>	<input type="checkbox"/>
T-SEQ	<input type="checkbox"/>	<input type="checkbox"/>	<input type="checkbox"/>	<input type="checkbox"/>	<input type="checkbox"/>	P-SEQ Select	<input type="checkbox"/>	<input type="checkbox"/>	<input type="checkbox"/>	<input type="checkbox"/>	<input type="checkbox"/>
G-SEQ	<input type="checkbox"/>	<input type="checkbox"/>	<input type="checkbox"/>	<input type="checkbox"/>	<input type="checkbox"/>	T-SEQ Select	<input type="checkbox"/>	<input type="checkbox"/>	<input type="checkbox"/>	<input type="checkbox"/>	<input type="checkbox"/>
Timer	<input type="checkbox"/>	<input type="checkbox"/>	<input type="checkbox"/>	<input type="checkbox"/>	<input type="checkbox"/>	G-SEQ Select	<input type="checkbox"/>	<input type="checkbox"/>	<input type="checkbox"/>	<input type="checkbox"/>	<input type="checkbox"/>
Alarm	<input type="checkbox"/>	<input type="checkbox"/>	<input type="checkbox"/>	<input type="checkbox"/>	<input type="checkbox"/>	Alarm ACK/RST	<input type="checkbox"/>	<input type="checkbox"/>	<input type="checkbox"/>	<input type="checkbox"/>	<input type="checkbox"/>
Operator	<input type="checkbox"/>	<input type="checkbox"/>	<input type="checkbox"/>	<input type="checkbox"/>	<input type="checkbox"/>	Priority Lock	<input type="checkbox"/>	<input type="checkbox"/>	<input type="checkbox"/>	<input type="checkbox"/>	<input type="checkbox"/>
Camera Title	<input type="checkbox"/>	<input type="checkbox"/>	<input type="checkbox"/>	<input type="checkbox"/>	<input type="checkbox"/>	MONI in Select	<input type="checkbox"/>	<input type="checkbox"/>	<input type="checkbox"/>	<input type="checkbox"/>	<input type="checkbox"/>
Controller	<input type="checkbox"/>	<input type="checkbox"/>	<input type="checkbox"/>	<input type="checkbox"/>	<input type="checkbox"/>						
EXT Timing	<input type="checkbox"/>	<input type="checkbox"/>	<input type="checkbox"/>	<input type="checkbox"/>	<input type="checkbox"/>						
COMP/VD2	<input type="checkbox"/>	<input type="checkbox"/>	<input type="checkbox"/>	<input type="checkbox"/>	<input type="checkbox"/>						
RS-485 Site	<input type="checkbox"/>	<input type="checkbox"/>	<input type="checkbox"/>	<input type="checkbox"/>	<input type="checkbox"/>						
Commu. Speed	<input type="checkbox"/>	<input type="checkbox"/>	<input type="checkbox"/>	<input type="checkbox"/>	<input type="checkbox"/>						
Clock	<input type="checkbox"/>	<input type="checkbox"/>	<input type="checkbox"/>	<input type="checkbox"/>	<input type="checkbox"/>						
Auto Cleaning	<input type="checkbox"/>	<input type="checkbox"/>	<input type="checkbox"/>	<input type="checkbox"/>	<input type="checkbox"/>						

□...OK ■...NG

F1:-- F2:-- F3:-- F4:Pop Up

To program or edit a Level Table, do the following:

1. Move the cursor to position 3 by moving the Joystick Controller, then press the **CAM (SET)** key to execute the selection.
2. Move the cursor to position 4 by moving the Joystick Controller.
Press the Function **F4** button to open the Pop Up Window.
Select the desired level by moving the Joystick Controller, and then press the **CAM (SET)** key to execute the selection.
 - : Enables the functions or operations.
 - : Disables the functions or operations.
3. Repeat the above procedures until all items are programmed.
4. After completing level assignment, press the **MON (ESC)** key to escape from the programming mode. The cursor returns to position 3.

● Operator Registration

This table is used to establish operator numbers for the users of the system along with associated passwords, operator levels and priorities.

Up to 30 operators may be registered.

Additionally, operator limits for camera access are set on this table.

Operator 01 Page 1 of 2

Level	5					Priority	10					Password	1 2 3 4 5				
CAM	01	02	03	04	05	06	07	08	09	10	11	12	13	14	15	16	
SEL	<input type="checkbox"/>	<input type="checkbox"/>	<input type="checkbox"/>	<input type="checkbox"/>	<input type="checkbox"/>	<input type="checkbox"/>	<input type="checkbox"/>	<input type="checkbox"/>	<input type="checkbox"/>	<input type="checkbox"/>	<input type="checkbox"/>	<input type="checkbox"/>	<input type="checkbox"/>	<input type="checkbox"/>	<input type="checkbox"/>	<input type="checkbox"/>	
CAM	17	18	19	20	21	22	23	24	25	26	27	28	29	30	31	32	
SEL	<input type="checkbox"/>	<input type="checkbox"/>	<input type="checkbox"/>	<input type="checkbox"/>	<input type="checkbox"/>	<input type="checkbox"/>	<input type="checkbox"/>	<input type="checkbox"/>	<input type="checkbox"/>	<input type="checkbox"/>	<input type="checkbox"/>	<input type="checkbox"/>	<input type="checkbox"/>	<input type="checkbox"/>	<input type="checkbox"/>	<input type="checkbox"/>	
CAM	33	34	35	36	37	38	39	40	41	42	43	44	45	46	47	48	
SEL	<input type="checkbox"/>	<input type="checkbox"/>	<input type="checkbox"/>	<input type="checkbox"/>	<input type="checkbox"/>	<input type="checkbox"/>	<input type="checkbox"/>	<input type="checkbox"/>	<input type="checkbox"/>	<input type="checkbox"/>	<input type="checkbox"/>	<input type="checkbox"/>	<input type="checkbox"/>	<input type="checkbox"/>	<input type="checkbox"/>	<input type="checkbox"/>	
CAM	49	50	51	52	53	54	55	56	57	58	59	60	61	62	63	64	
SEL	<input type="checkbox"/>	<input type="checkbox"/>	<input type="checkbox"/>	<input type="checkbox"/>	<input type="checkbox"/>	<input type="checkbox"/>	<input type="checkbox"/>	<input type="checkbox"/>	<input type="checkbox"/>	<input type="checkbox"/>	<input type="checkbox"/>	<input type="checkbox"/>	<input type="checkbox"/>	<input type="checkbox"/>	<input type="checkbox"/>	<input type="checkbox"/>	

..Video & PTZ Cont.
 ..Video Only
 ..Video Lockout

F1:Next Page F2:Pre Page F3:DEL F4:Pop Up

To program or edit the Registration Table, do the following:

1. Move the cursor to position 3 by moving the Joystick Controller.
Enter an operator number (1-30) by pressing the Numeric keys, and then press the **CAM (SET)** key.
2. Move the cursor to position 4 by moving the Joystick Controller.
Enter the desired Level number (1-5) by pressing the Numeric keys.
3. Move the cursor to position 5 by moving the Joystick Controller.
Enter the desired Priority number (1-30) by pressing the Numeric keys.
4. Move the cursor to position 6 by moving the Joystick Controller.
Enter a 5-digit Password Number by pressing the Numeric keys.
5. Move the cursor to position 7 by moving the Joystick Controller.
Press the **INC +1CAM** button or **DEC -1CAM** button repeatedly to select the desired operator limit displayed on the table.
 - : Enables Video and pan/Tilt control.
 - : Enables only Video Control.
 - : Disables control.
6. Repeat the above procedures until all operator limits are completed in this table.
7. After completing the table, press the Function **F1** button to select the next page. Repeat the above procedures until all operator limits have been established.
8. Press the Function **F2** button to back up to the previous page.
9. When satisfied with all of the above steps, press the **MON (ESC)** key to escape from the programming mode.
The cursor returns to position 3.
10. Similarly, repeat the above procedures to register all other operators.

Notes:

- Operator number 00 is allotted to the Timer.
The factory default setting is priority 30.
- If the system is operated by programmed Timer Events, it is recommended to use higher priorities (lower numbers).
If the system is operated manually by an operator, use lower priorities (higher numbers).

Cautions:

- To prevent unauthorized access, be sure to change the Password preset at the factory.
- If an operator's level for access to the item "Set Up Menu" or "Operator" on the Level Table has not been registered, the operator will not be allowed access to the Set Up Menu a second time.

■ Camera Title

This table is used to edit the camera titles to be displayed on the monitor screen.

There are 128 camera titles available.

Each title is composed of 15 characters per line, times 2 lines.

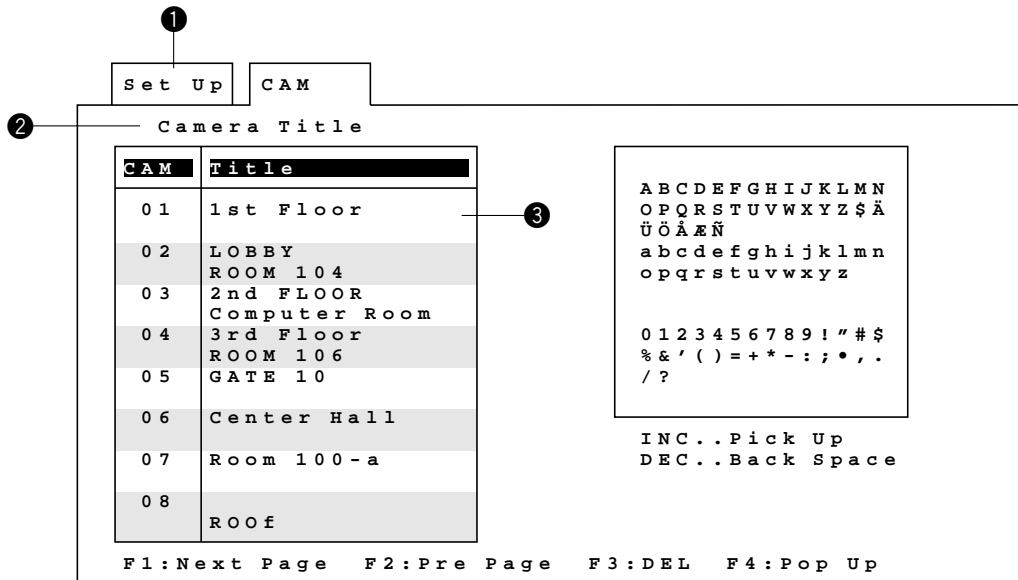

To program or edit the Camera Title Table, do the following:

1. Move the cursor to position 2 by moving the Joystick Controller, then press the **CAM (SET)** key.
2. Move the cursor with the Joystick Controller to the desired camera number to edit a title (position 3).
Press the Function **F4** button to open the Pop Up Window.
The character table appears to the right of the Camera Title table as shown above.
3. Select the desired character from the table by moving the Joystick Controller. Then press the **INC +1CAM** button to pick up the character, and place it in the title editing area.
4. If a wrong character is selected, press the **DEC -1CAM** button to delete the character positioned immediately to the left of the cursor.
Select a character by moving the Joystick, and then press the **INC +1CAM** button to replace the character where the cursor is positioned.
5. Repeat the above procedures until the title for a selected camera is completed.
Then press the **CAM (SET)** key to save that title. The character table disappears.
6. Repeat the above procedures to edit other camera titles on this page.
When satisfied with the titles, press the Function **F1** button to select the next page. Repeat the above procedures until the titles for all cameras are completed.
7. Press the Function **F2** button to go back to the previous page.
8. When satisfied with all the camera titles, press the **MON (ESC)** key to escape from the programming mode.
The cursor returns to position 2.

Alarm Recall

There are 99 alarm records stored in chronological order in 7 pages of tables.

The tables also show all monitor numbers involved when Alarm Mode-3 is activated, and indicate the alarm mode number when Alarm Mode-1 or Alarm Mode-2 is activated.

Set Up		AL REC		
Alarm Recall				Page 1 of 7
NO.	Date	Alarm	Monitor	
53	14 JUN. 23:09:11	1-009	01 02 03 04 05 06 07 08 >	
52	11 JUN. 10:32:37	1-021	06	
51	05 MAY. 01:12:08	0-062	10	
50	03 MAR. 21:59:00	1-012	10 11 12	
49	03 MAR. 12:00:00	1-026	04 16	
48	03 MAR. 11:59:20	1-108	01	
47	26 FEB. 23:59:00	0-008	09	
46	25 FEB. 00:00:00	0-117	16	
45	02 FEB. 12:47:32	0-047	11 15	
44	11 JAN. 02:00:00	1-010	Mode 2	
43	01 JAN. 00:00:01	1-063	Mode 2	
42	25 DEC. 23:00:00	1-059	Mode 2	
41	11 NOV. 08:28:59	1-042	Mode 1	
40	21 AUG. 09:07:16	1-039	Mode 1	
39	11 AUG. 21:09:37	1-011	Mode 1	
38	31 JUL. 11:11:11	1-006	06	

F1: Next Page F2: Pre Page F3: -- F4: --

Press the Function **F1** button to select the next page. Press the Function **F2** button to back up to the previous page.

Note: The Alarm column lists the following:

- 0: Camera Site Alarm with corresponding Camera number.
- 1: Alarm Board Input with alarm input number.

4

Status

This table shows the system status in real time.

Set Up		Status		DEC.07'00 23:59:59		
Status						
MONITOR	CAMERA	MODE	CTRLR	OPERATOR	PRIORITY	
01	11	T 01 F	1	01	05	
02 in	21	SPOT			00	
03	09	T 08 F			--	
04	48	G 2 S			--	
05	63	G 2 S			--	
06	17	G 2 S			--	
07	10	CAM	2	11	01	
08	03	SET	8	02	03	
09	35	T 64 F			00	
10	09	SPOT	4	26	10	
11	49	T 11 F			03	
12	53	G 1 B			02	
13	49	G 1 B			02	
14	26	G 1 B			02	
15	30	P	5	21	30	
16	51	P F			--	

F1: -- F2: -- F3: -- F4: --

Possible active modes, as indicated in this table, are defined below.

- in : Displays video connected to the Video Output Board
- SPOT : Spot
- P : Program Sequence
- T : Tour Sequence
- G : Group Sequence
- CAM : Camera Setting

- SET : Setup
- F : Forward Sequence
- B : Backward Sequence
- S : Paused

Note: If the monitor is connected to the CPU Board, this table is always displayed on the monitor.

■ System Menu

As shown below, the system menu allows access to six items.

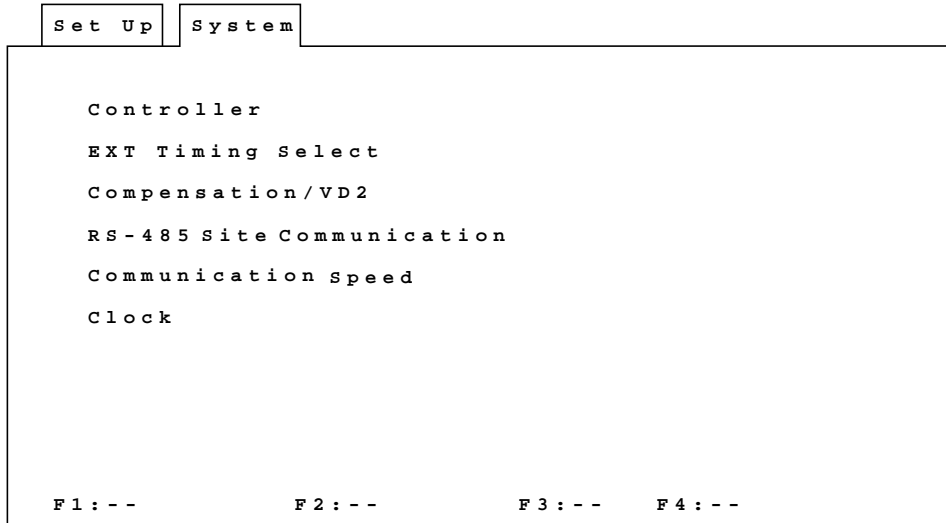

To select an item from the **System Menu**:

1. Select the desired item by moving the Joystick Controller.
2. To execute the selection, press the **CAM (SET)** key.
The selected menu appears on the monitor.
3. To return to the Set Up Menu, press the **MON (ESC)** key.

● Controller (Controller-Monitor Partitioning)

This table is used to prevent specific WV-CU550CJ System controllers from ever controlling the outputs of specific monitors. This feature prevents an operator from unintentionally gaining control over a monitor that may not be associated with his/her station.

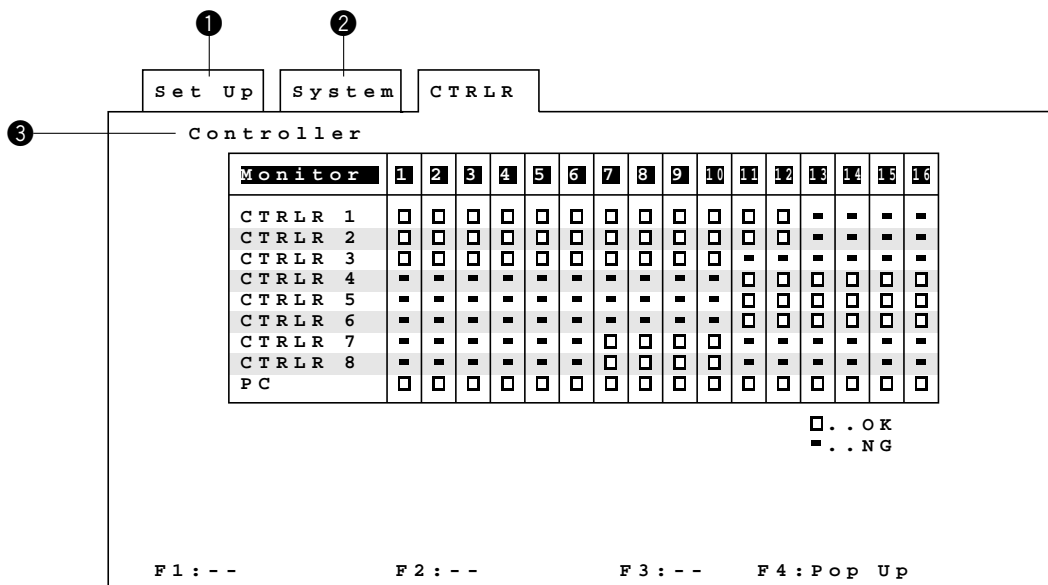

To program or edit the Controller Table, do the following:

1. Move the cursor to position 3 by moving the Joystick Controller, then press the **CAM (SET)** key.
2. Move the cursor to the desired controller and monitor position by moving the Joystick Controller. Press the **INC +1CAM** button or **DEC -1CAM** button repeatedly to select or .
 : Approval (OK)
 : Prohibition (NG)
3. Repeat the above procedure until the table is completed.
4. After completing the table, press the **MON (ESC)** key to escape from the programming mode. The cursor returns to position 3.

● EXT (External) Timing Select

This table permits the sequence dwell time on the selected monitor to be synchronized with the time lapse mode set in the associated Time Lapse VTR.

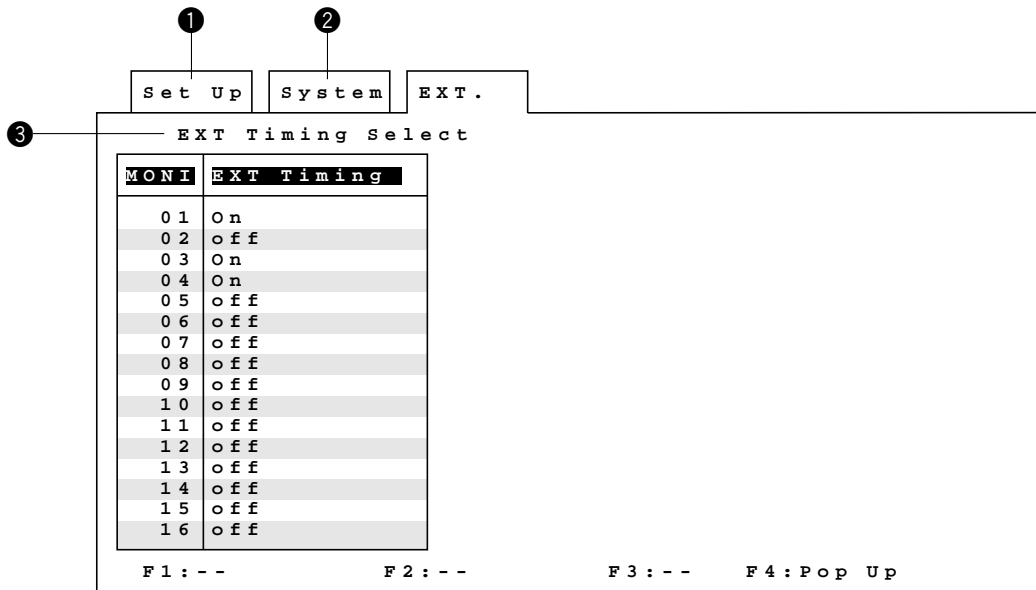

To program or edit the EXT Timing Select Table, do the following:

1. Move the cursor to position 3 by moving the Joystick Controller, then press the **CAM (SET)** key.
2. Move the cursor to the desired monitor position by moving the Joystick Controller.
Press the Function **F4** button to open the Pop Up Window. Select EXT On or Off by moving the Joystick Controller, and then press the **CAM (SET)** key to execute the selection.
3. When satisfied with all settings, press the **MON (ESC)** key to escape from the programming mode.
The cursor returns to position 3.

Note: If External Timing is selected for a monitor, any Dwell Time programmed on the sequence tables for that monitor will be invalid.

Minimum duration for camera switching pulse is one (1) second.

● Compensation/VD2

This table is used to select a cable length for cable loss compensation, and to turn the vertical drive sync signal (VD2) and the control data for the cameras on or off.

Set Up System COM / VD

Compensation / VD2 Page 1 of 2

CAM	01	02	03	04	05	06	07	08	09	10	11	12	13	14	15	16
COMP	L	M	S	M	S	S	S	S	S	S	S	S	S	S	S	S
VD2	<input type="checkbox"/>	<input type="checkbox"/>	<input type="checkbox"/>	<input type="checkbox"/>	<input type="checkbox"/>	<input type="checkbox"/>	<input type="checkbox"/>	<input type="checkbox"/>	<input type="checkbox"/>	<input type="checkbox"/>	<input type="checkbox"/>	<input type="checkbox"/>	<input type="checkbox"/>	<input type="checkbox"/>	<input type="checkbox"/>	<input type="checkbox"/>
CAM	17	18	19	20	21	22	23	24	25	26	27	28	29	30	31	32
COMP	S	S	S	S	S	S	S	S	S	S	S	S	S	S	S	S
VD2	<input type="checkbox"/>	<input type="checkbox"/>	<input type="checkbox"/>	<input type="checkbox"/>	<input type="checkbox"/>	<input type="checkbox"/>	<input type="checkbox"/>	<input type="checkbox"/>	<input type="checkbox"/>	<input type="checkbox"/>	<input type="checkbox"/>	<input type="checkbox"/>	<input type="checkbox"/>	<input type="checkbox"/>	<input type="checkbox"/>	<input type="checkbox"/>
CAM	33	34	35	36	37	38	39	40	41	42	43	44	45	46	47	48
COMP	S	S	S	S	S	S	S	S	S	S	S	S	S	S	S	S
VD2	<input type="checkbox"/>	<input type="checkbox"/>	<input type="checkbox"/>	<input type="checkbox"/>	<input type="checkbox"/>	<input type="checkbox"/>	<input type="checkbox"/>	<input type="checkbox"/>	<input type="checkbox"/>	<input type="checkbox"/>	<input type="checkbox"/>	<input type="checkbox"/>	<input type="checkbox"/>	<input type="checkbox"/>	<input type="checkbox"/>	<input type="checkbox"/>
CAM	49	50	51	52	53	54	55	56	57	58	59	60	61	62	63	64
COMP	S	S	S	S	S	S	S	S	S	S	S	S	S	S	S	S
VD2	<input type="checkbox"/>	<input type="checkbox"/>	<input type="checkbox"/>	<input type="checkbox"/>	<input type="checkbox"/>	<input type="checkbox"/>	<input type="checkbox"/>	<input type="checkbox"/>	<input type="checkbox"/>	<input type="checkbox"/>	<input type="checkbox"/>	<input type="checkbox"/>	<input type="checkbox"/>	<input type="checkbox"/>	<input type="checkbox"/>	<input type="checkbox"/>

S .. Short
M .. Middle VD2 & Data
L .. Long

.. On
 .. Off

F1: Next Page F2: Pre Page F3: -- F4: Pop Up

To program or edit the Compensation/VD2 Table, do the following:

1. Move the cursor to position 3 by moving the Joystick Controller, then press the **CAM (SET)** key.
2. Move the cursor to position 4 by moving the Joystick Controller.

Press the **INC +1CAM** button or **DEC -1CAM** button repeatedly to select the most suitable cable length as shown below.

- S:** Up to 500 m (1 600 ft)
M: 500 m (1 600 ft) to 900 m (2 900 ft)
L: 900 m (2 900 ft) to 1 200 m (4 000 ft)
(using RG-6/U or equivalent cable)

3. Move the cursor to position 5 by moving the Joystick Controller.

Press the **INC +1CAM** button or **DEC -1CAM** button to select VD2 On or Off and Data On or Off.

- VD2:** Select On if the camera is VD2 compatible, otherwise select Off.
Data: Select On if the corresponding camera site units are connected, otherwise select Off.

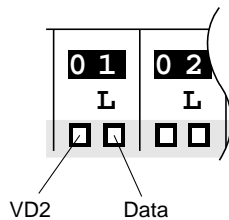

4. Repeat the above procedures until the table is completed.
5. After completing the table, press the Function **F1** button to select the next page. Repeat the above procedures until all camera settings are completed.
6. Press the Function **F2** button to back up to the previous page.
7. When all above settings are completed, press the **MON (ESC)** key to escape from the programming mode. The cursor returns to position 3.

● RS-485 Site Communication

This table is used to set the parameters for communication between the Data Boards installed in the Matrix Switcher and the Camera Site.

RS-485 Site Communication

Board Addr. 1

Camera In Number	F/H Duplex	Delay Time	Baud Rate	Wait Time	Data Bit	Parity Check	Stop Bit
# 1	02 Full	Off	19200	Off	8	None	1
# 2	04 Half	Off	9600	Off	8	None	1
# 3	06 Full	100	19200	Off	8	None	1
# 4	Full	Off	19200	Off	8	None	1
# 5	10 Full	Off	1200	Off	8	None	1
# 6	Full	Off	19200	Off	8	None	1
# 7	Full	Off	19200	Off	8	None	1
# 8	Full	Off	19200	Off	8	None	1

When Daisy Mode is "on" only #1 will be available

F1: -- F2: -- F3: DEL F4: Pop Up

To program or edit the RS-485 Communication Table, do the following:

1. Move the cursor to position 3 by moving the Joystick Controller.
Enter the desired data board number (1-8) by pressing the Numeric key, then press the **CAM (SET)** key.
2. Move the cursor to position 4 by moving the Joystick Controller.
Press the Function **F4** Button to open the Pop Up Window. Select Daisy-Chain connection (On) or Home Run Connection (Off) by moving the Joystick Controller, and then press the **CAM (SET)** key to execute the selection.
3. Move the cursor to position 5 by moving the Joystick Controller.
Enter the desired camera number for site communication by pressing the Numeric keys, and then press the **CAM (SET)** key to execute the selection.
4. Move the cursor to position 6 by moving the Joystick Controller.
Press the Function **F4** button to open the Pop Up Window. Select Full or Half Duplex by moving the Joystick Controller, and then press the **CAM (SET)** key to execute the selection.
5. Move the cursor to position 7 by moving the Joystick Controller.
Press the Function **F4** Button to open the Pop Up Window. Select the desired Delay Time by moving the Joystick Controller, and then press the **CAM (SET)** key to execute the selection.
6. Move the cursor to position 8 by moving the Joystick Controller.
Press the Function **F4** button to open the Pop Up Window. Select the desired Baud Rate by moving the Joystick Controller, and then press the **CAM (SET)** key to execute the selection.
7. Move the cursor to position 9 by moving the Joystick Controller.
Press the Function **F4** button to open the Pop Up Window. Select the desired Wait Time by moving the Joystick Controller, and then press the **CAM (SET)** key to execute the selection.
8. Repeat the above procedures until the table is completed.
9. When all settings are completed, press the **MON (ESC)** key to escape from the programming mode.
The cursor returns to position 3.

● Communication Speed

This table is used to set the parameters for communication between the System Controllers (or PCs) and the Matrix Switcher.

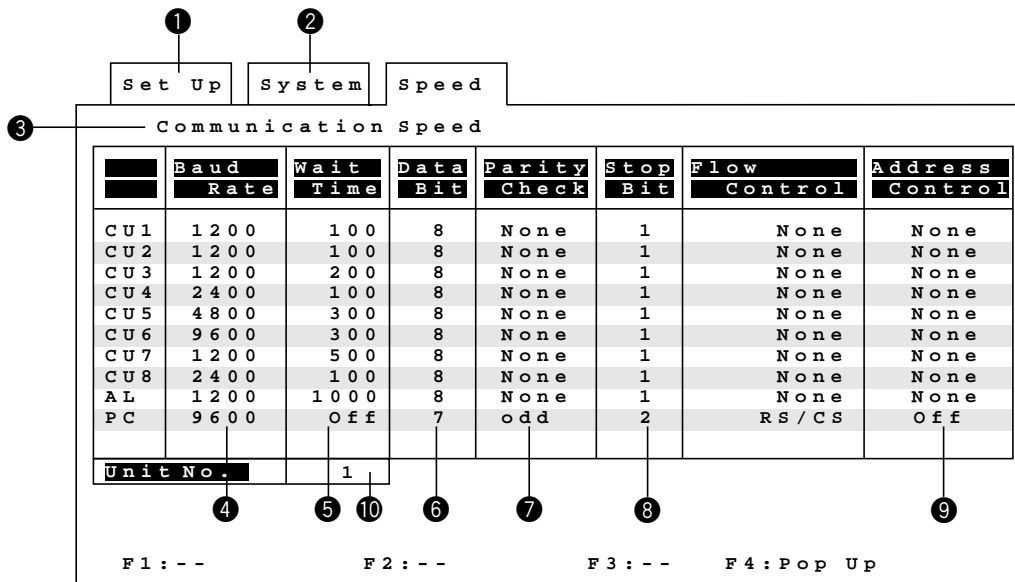

To program or edit the Communication Speed Table, do the following:

1. Move the cursor to position 3 by moving the Joystick Controller, then press the **CAM (SET)** key.
2. Move the Cursor to position 4 by moving the Joystick Controller.
Press the Function **F4** button to open the Pop Up Window. Select the desired Baud Rate by moving the Joystick Controller, and then press the **CAM (SET)** key to execute the selection.
3. Move the Cursor to position 5 by moving the Joystick Controller.
Press the Function **F4** button to open the Pop Up Window. Select the desired Wait Time by moving the Joystick Controller, and then press the **CAM (SET)** key to execute the selection.
4. Move the Cursor to position 6 by moving the Joystick Controller.
Press the Function **F4** button to open the Pop Up Window. Select the desired Data Bit by moving the Joystick Controller, and then press the **CAM (SET)** key to execute the selection.
5. Move the Cursor to position 7 by moving the Joystick Controller.
Press the Function **F4** button to open the Pop Up Window. Select the desired Parity Check by moving the Joystick Controller, and then press the **CAM (SET)** key to execute the selection.
6. Move the Cursor to position 8 by moving the Joystick Controller.
Press the Function **F4** button to open the Pop Up Window. Select the desired Stop Bit by moving the Joystick Controller, and then press the **CAM (SET)** key to execute the selection.
7. Move the cursor to position 9 by moving the Joystick Controller.
Press the Function **F4** button to open the Pop Up Window. Select Address Control On or Off by moving the Joystick Controller, and then press the **CAM (SET)** key to execute the selection.
8. Move the cursor to position 10 by moving the Joystick Controller.
Enter the desired Unit Number (1-16) by pressing the Numeric keys, and then press the **CAM (SET)** key to enter the Unit Address.
9. Repeat the above procedures until the table is completed.
10. When all settings are completed, press the **MON (ESC)** key to escape from the programming mode.
The cursor returns to position 3.

● Clock Set

This table is used to set the current time and date.

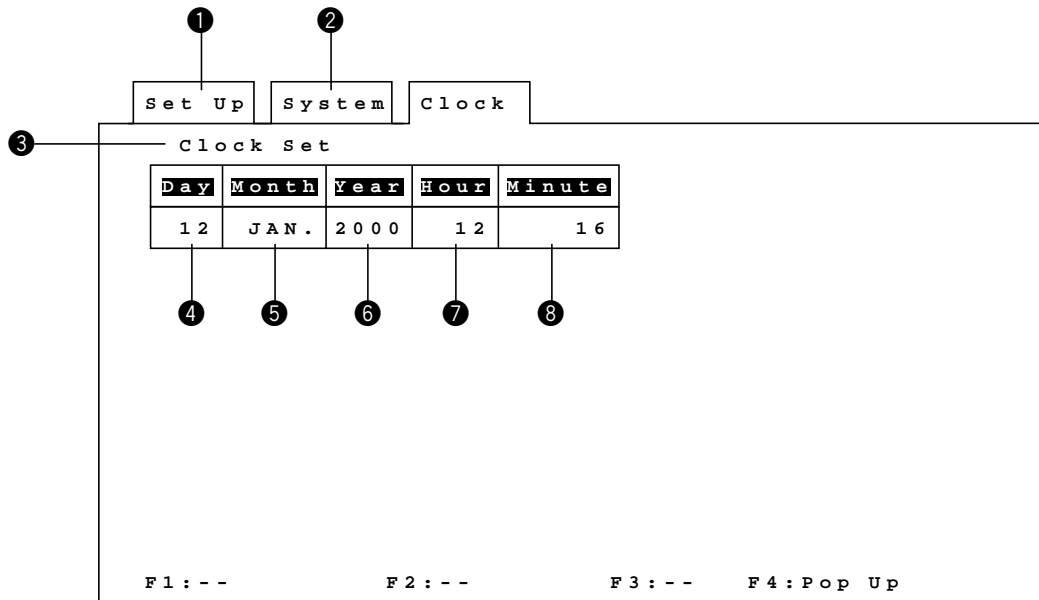

To program or edit the Clock Set Table, do the following:

1. Move the cursor to position 3 by moving the Joystick Controller, then press the **CAM (SET)** key.
2. Move the cursor to position 4 by moving the Joystick Controller.
Enter the desired date by pressing the Numeric keys.
3. Move the cursor to position 5 by moving the Joystick Controller.
Press the Function **F4** button to open the Pop Up Window.
Select the desired month by moving the Joystick Controller, and then press the **CAM (SET)** key to execute the selection.
4. Move the Cursor to position 6 by moving the Joystick Controller.
Enter the desired year by pressing the Numeric key.
5. Move the cursor to position 7 by moving the Joystick Controller.
Enter the desired hours (military time) by pressing the Numeric keys.
6. Move the cursor to position 8 by moving the Joystick Controller.
Enter the desired minutes by pressing the Numeric keys.
7. Press the **MON (ESC)** key to escape from the programming mode.
The cursor returns to position 3.

Note: The date and time are updated when the **MON (ESC)** key is pressed.

■ Auto Cleaning

Auto Cleaning is for cleaning the electric-mechanical contacts of the Panasonic combination cameras. Use this function for maintenance when the camera has been directed at the same spot or panned over the same range for a long time.

This table is used to enable and disable the auto cleaning function of the specified combination cameras at a user-specified time or date.

Auto Cleaning Page Page 1 of 2

	Mode																Hour		Minute	
	Manual																23		00	
CAM 01	01	02	03	04	05	06	07	08	09	10	11	12	13	14	15	16	01	02	00	01
CAM 17	17	18	19	20	21	22	23	24	25	26	27	28	29	30	31	32	03	04	00	01
CAM 33	33	34	35	36	37	38	39	40	41	42	43	44	45	46	47	48	05	06	00	01
CAM 49	49	50	51	52	53	54	55	56	57	58	59	60	61	62	63	64	07	08	00	01

F1: Next Page F2: Pre Page F3: -- F4: --

Now cleaning
To stop Cleaning, Press ESC.

To program or edit the Auto Cleaning Table, do the following:

1. Move the cursor to position 2 by moving the Joystick Controller, then press the **CAM (SET)** key.
2. Move the Cursor to position 3 by moving the Joystick Controller. Select the desired Mode by pressing the **INC +1CAM** button or **DEC -1CAM** button.
 - Manual:** Operator controlled Auto Cleaning
 - Timer:** Timer controlled Auto Cleaning
3. Move the Cursor to position 4 by moving the Joystick Controller. Select the desired Day for timer operation by pressing the **INC +1CAM** button or **DEC -1CAM** button repeatedly.
 - Daily:** Daily Auto Cleaning
 - Sunday - Saturday:** Auto Cleaning on selected days of the week
 - 01 - 31:** Auto Cleaning on selected days of the month
4. Move the Cursor to position 5 by moving the Joystick Controller. Select the desired Hours by pressing the **INC +1CAM** button or **DEC -1CAM** button repeatedly.
5. Move the Cursor to position 6 by moving the Joystick Controller. Select the desired Minutes by pressing the **INC +1CAM** button or **DEC -1CAM** button repeatedly.
6. Move the Cursor to the desired camera number (position 7) by moving the Joystick Controller. Select or by pressing the **INC +1CAM** button or **DEC -1CAM** button.
 - : Cleaning is enabled (Cleaning mode on)
 - : Cleaning is disabled (Cleaning mode off)
7. Repeat the above procedure for other cameras on this page.
8. When satisfied with the settings, press the Function **F1** button to select the next page. Repeat the above procedures until the settings for all cameras are completed.
9. Press the Function **F2** button to go back to the previous page.
10. When satisfied with all camera settings, press the **MON (ESC)** key to escape from the programming mode. The cursor returns to position 2.

- **Display of Cleaning Result**

Cleaning proceeds in the order of the camera numbers, starting with the lowest number.
The table shows the cleaning result for the cameras (position 8).

- : Cleaning is completed.
- : Cleaning is disabled.

Note: While either manually or timer controlled cleaning is in progress, the camera controlled manually or automatically from the system is disabled cleaning.

- **Manual Cleaning**

Move the cursor to position 3 and select Manual, then press the **CAM (SET)** key to execute cleaning manually.
The pop-up window "NOW CLEANING" appears on the table.
To quit cleaning, press the **MON (ESC)** key.

SECTION 5
OPERATING
PROCEDURES

OPERATING PROCEDURE

Before starting the following procedures, all system components should be turned on.

■ Log-in

1. Turn on the power switches of all system components.

Caution: If the WJ-AD550 Extension Unit is used in the system, turn the Extension Unit power on before turning on the power of the WJ-SX550C Matrix Switcher.

2. Turn on the power of the system controller by pressing the Controller On/Off Switch located on the rear of the System Controller to the ON position.
The following displays appear on the LCD display.

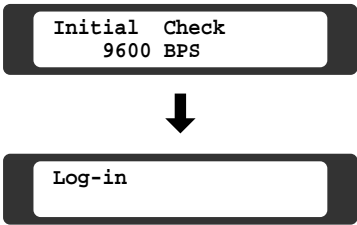

3. Press the **CAM (SET)** key, the Operator No. display now appears on the LCD display.

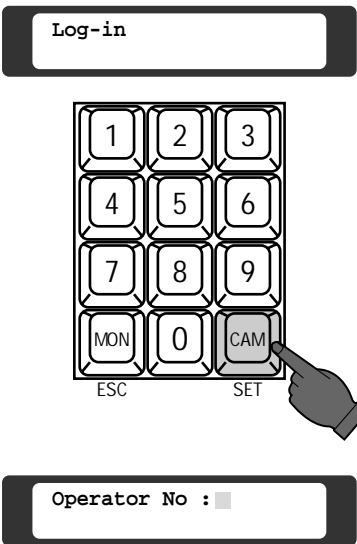

4. Select your registered Operator Number (up to 30) by pressing the Numeric keys, then press the **CAM (SET)** key.
The initial factory setting is 1.

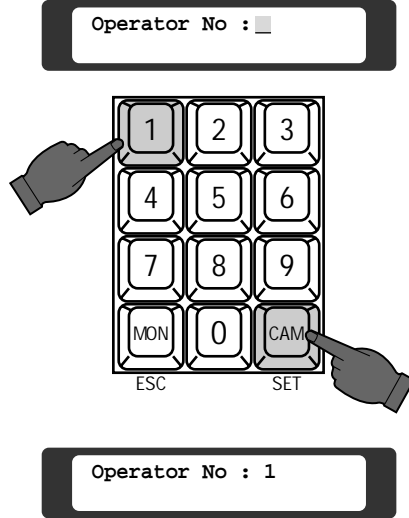

See page 81 for details on registering operator numbers.

5. Select your registered Password (five digits) by pressing the Numeric keys.
The initial factory setting is 12345.

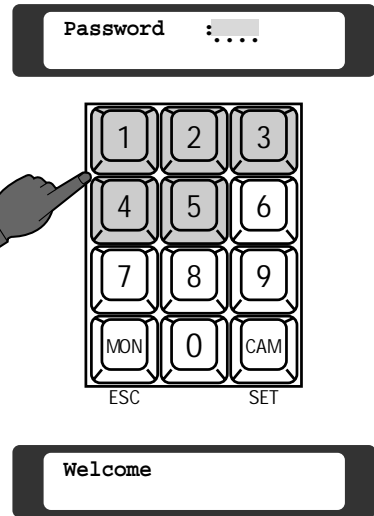

See page 81 for details on registering password numbers.

Note: If the Auto Log-in setting is set to On mode, any operator can Log-in automatically as any operators previously.
Refer to the Auto Log-in Setting on page 124.
The Auto Log-in function may not work, if a previous operator has not logged out properly. In this case, follow the above procedure to log in manually.

If an incorrect operator number or password is selected, "No Entry" is displayed on the LCD display and the Log-in procedure automatically returns to the start.

"Monitor Busy" will appear on the LCD display when another operator, with a higher operator priority, is currently controlling the monitor outputs. The Log-in procedure automatically returns to the start.

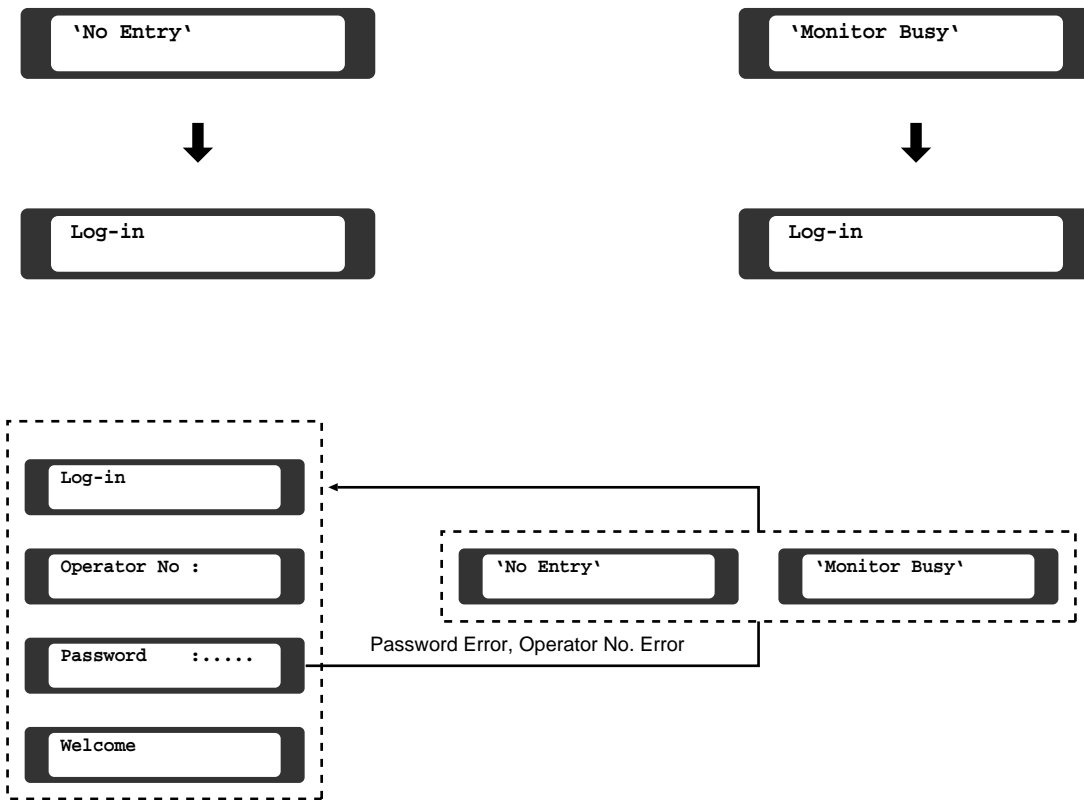

■ Operation Menus

After log-in, the following operation menus are available on the LCD display by pressing the appropriate Direction buttons. For example, to go from the Camera/Monitor Selection Menu (A1) to the Shutter Selection Menu (C1), press the ► button twice.

To go from the G-Seq Selection Menu to the Set Up Menu, press the ▼ button four times.

To actually set the Set Up Menu to the active or on mode, press the F1 button while the Set Up Menu is displayed on the LCD display.

Notes:

- Pressing the ◀ and ▶ buttons simultaneously will display the top left menu on the LCD display.
- After selecting the menu by pressing the appropriate Direction buttons, the Menu Number (A1 to D5) will be displayed for 2 seconds in the upper right corner of the LCD display.

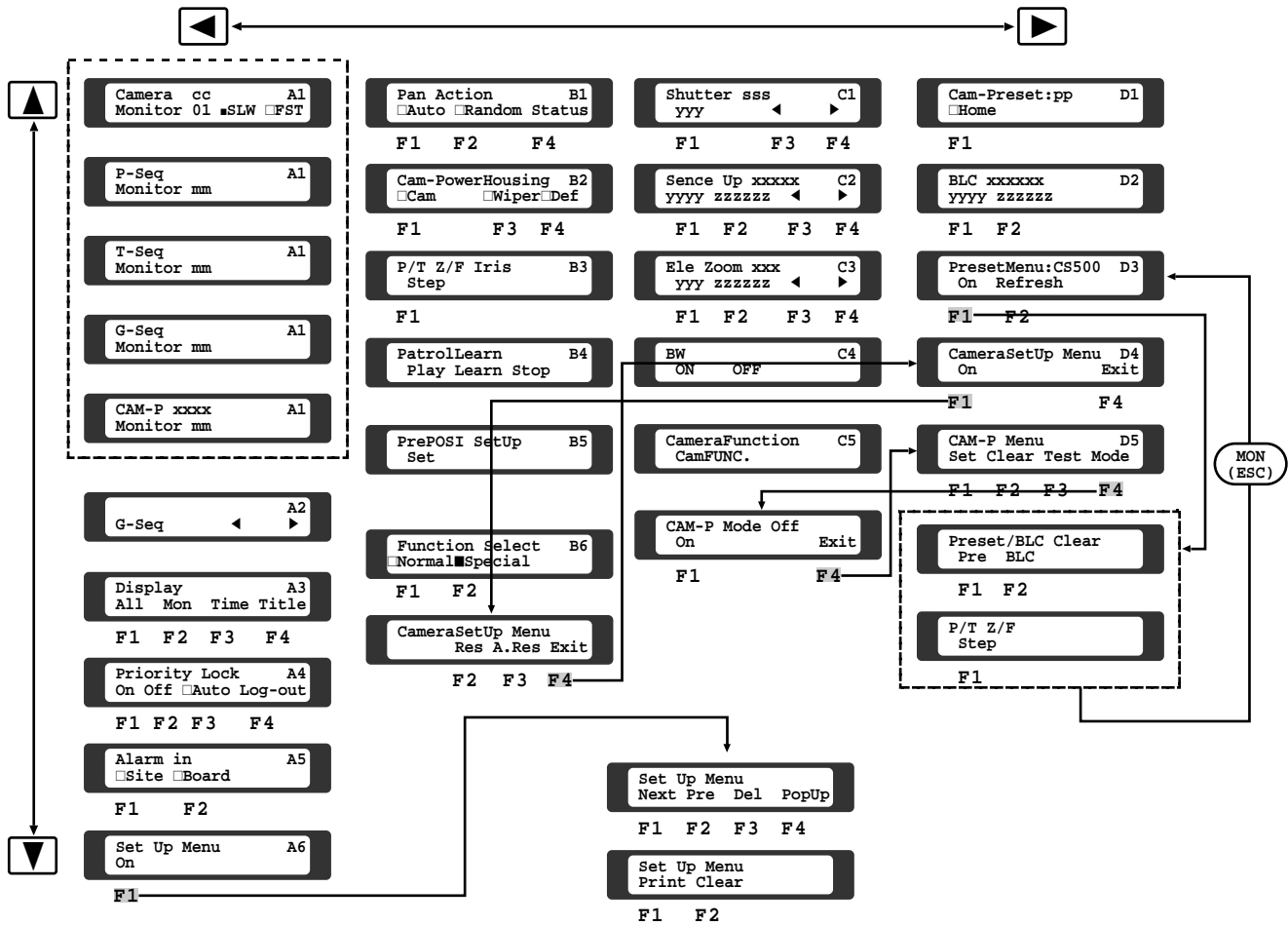

Note: The CAM-P Menu (D5) is shown only when the Mode Selection Switch on the rear of the controller is set to the CAM-P Mode. Refer to the Mode Selection on page 52.

■ Monitor Selection

Select the desired Monitor Number (1 to 16) by pressing the Numeric keys, then press the **MON (ESC)** key to execute the selection.

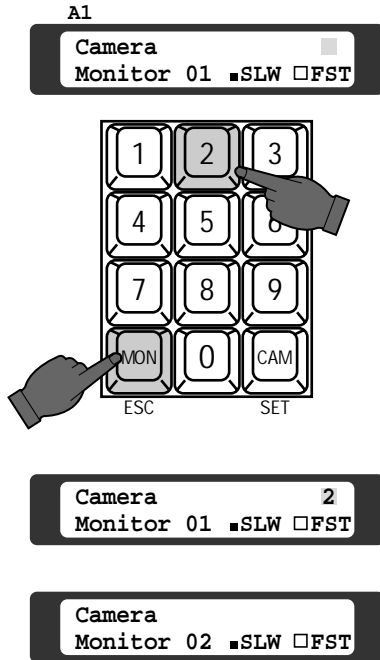

Notes:

- "Monitor Busy" appears on the LCD display, if the monitor is selected by a higher priority operator. Control of the same monitor is denied to an operator with a lower priority.
- If the CAM-P Mode is in On mode, press the Function (**F1**) button instead of the **MON (ESC)** key.

■ Camera Selection

1. Select the desired camera number by pressing the Numeric keys, then press the **CAM (SET)** key. The selected camera picture appears on the active monitor.

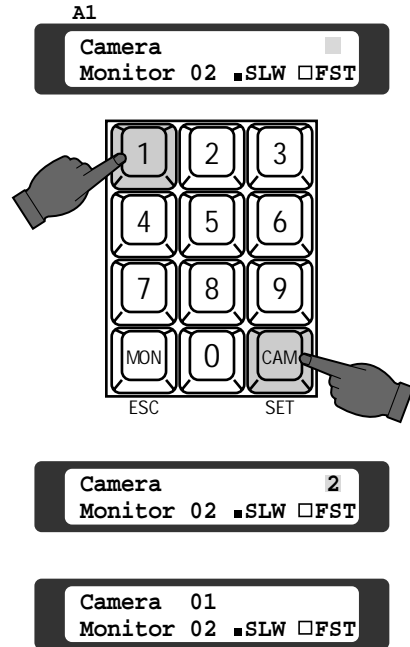

2. Press the **INC +1CAM** button to replace the currently selected camera with the next higher camera number.

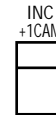

3. Press the **DEC -1CAM** button to replace the currently selected camera with the next lower camera number.



Notes:

- "PROHIBITED" is displayed on the LCD display, if control of the selected camera is disabled due to limited operator authorization.
- "Camera Busy" is displayed on the LCD display of the camera is selected by a higher priority operator. Control of the same camera is denied to an operator with a lower priority.

■ Contrast and Backlight Adjustment of LCD Display

The following procedure lets you adjust contrast and backlight of the controller's LCD display.

Pressing the Direction (◀, ▲, ▶) buttons at the same time will display the following on the LCD display.

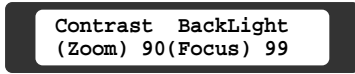

a) Contrast Adjustment

Pressing the **ZOOM TELE/WIDE** Control while holding down the Direction (◀, ▲, ▶) buttons at the same time will adjust the contrast of the characters displayed on the LCD display.

- TELE:** Increases the character contrast (00 → 99)
- WIDE:** Decreases the character contrast (99 → 00)

b) Backlight Adjustment

Pressing the **FOCUS NEAR/FAR** Control while holding down the Direction (◀, ▲, ▶) buttons at the same time will adjust the backlight of the LCD display.

- NEAR:** Increases the backlight brightness (00 → 99)
- FAR:** Decreases the backlight brightness (99 → 00)

2. Select the Function Select (**B6**) Menu on the LCD display by pressing the appropriate Direction buttons.

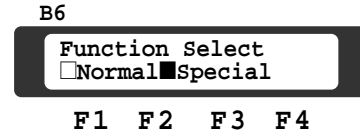

3. Press the **FOCUS NEAR/FAR** Control while observing the active monitor to adjust the lens focus to achieve a sharply focused picture.



Pressing the Top button on the Joystick Controller or the **PRESET/AF** button will automatically set the lens focus, if the specified camera with the auto focus feature is used.

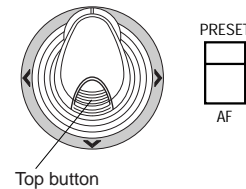

4. Moving the **Zoom Wheel** Controller can adjust the lens zoom to achieve the desired picture, while observing the active monitor.

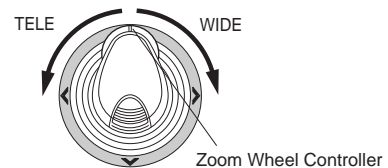

Move it rightward to zoom in the image.
Move it leftward to zoom out the image.

Pressing the **ZOOM TELE/WIDE** Control can also adjust the lens zoom.

Press the control to the **TELE** position to zoom in the image.

Press the control to the **WIDE** position to zoom out the image.



■ Controlling Camera Site Accessories

Controls for camera site accessories are located on the right side of the front panel of the System Controller. Included are Zoom Control, Focus Control, Iris Control, Preset and Pan/Tilt Controls. Normally combination cameras equipped with the specific feature of a WV-RC100, WV-RC150 or WV-RC170 Receiver are required to utilize these functions.

● Lens Control

Confirm that the specified lens with power zoom/focus functions is mounted on the camera. Also confirm that the Lens Selection Switch (DC/VIDEO) on the camera is set to the DC position.

Function capabilities vary between cameras. Referring to the operating instructions of each camera is recommended.

1. Select the desired monitor and camera.
Refer to the Monitor Selection and Camera Selection on page 98.

- Press the **IRIS CLOSE/OPEN** buttons to close/open the lens iris. Adjust the lens iris by using these buttons to obtain the proper picture exposure.

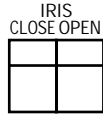

Pressing these buttons at the same time for three seconds or more will reset the lens iris to the factory default setting.

Note: When a camera, with an ALC Lens, has AGC turned on, the iris close, open function will operate more slowly. By pressing the above buttons repeatedly (instead of holding down), this function will operate faster.

- If Lens Control needs fine adjustment, follow the procedures shown below.
 - Select the desired monitor and camera.
 - Select the P/T Z/F Iris (**B3**) Menu on the LCD display by pressing the Direction buttons.



- Pressing the **Focus, Zoom** or **Iris** control while holding down the Function (**F1**) button will adjust the focus, zoom or lens iris step by step.

Note: Holding down the **STOP/SLOW** button and pressing the **Focus, Zoom** or **Iris** control, while the **ALT** indicator is on, will adjust the focus, zoom or lens iris step by step without displaying the P/T Z/F Iris Menu.

● Pan/Tilt Control (Manual Operation)

- Select the desired monitor and camera. Refer to the Monitor Selection and Camera Selection on page 98.
- Select a mode by pressing the [**F3**] or [**F4**] button. "□" indicates the currently selected mode.

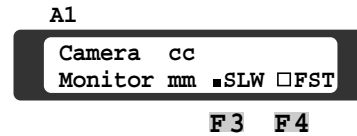

SLW: Moves the Pan/Tilt Head at lower speed.
FST: Moves the Pan/Tilt Head at higher speed.

Note: This function is available with the WV-CU550CJ system controller.

- Move the Joystick Controller to move the Pan/Tilt Head in the desired direction. If the joystick is positioned in between **▲** and **▼**, the Pan/Tilt Head moves diagonally upward and to the right. Eight directions are available: Up/Down/Right/Left/Up-Right/Up-Left/Down-Right/Down-Left.

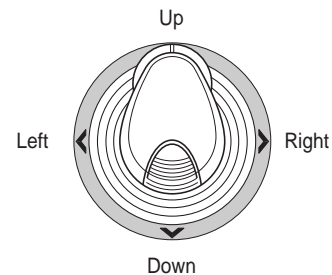

Note: When FST mode is selected, moving the Joystick Controller while holding down the **STOP/SLOW** button will move the Pan/Tilt Head at lower speed.

- If the Pan/Tilt Control needs fine adjustment, follow the procedures shown below.
 - Select the desired monitor and camera.
 - Select the P/T Z/F Iris (**B3**) Menu on the LCD display by pressing the Direction buttons.

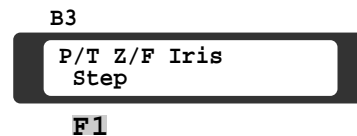

- Moving the Joystick Controller while holding down the Function (**F1**) button will move the Pan/Tilt Head step by step.

Note: Holding down the **STOP/SLOW** button and moving the Joystick Controller, while the **ALT** indicator is on, will move the Pan/Tilt Head step by step without displaying the P/T Z/F Iris Menu.

● Pan/Tilt Control (Preset Operation)

The following function requires the use of cameras equipped with the specific feature.

1. Select the desired monitor and camera.
Refer to the Monitor Selection and Camera Selection.
2. Select the preset position number by pressing the Numeric keys.

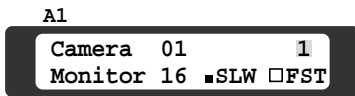
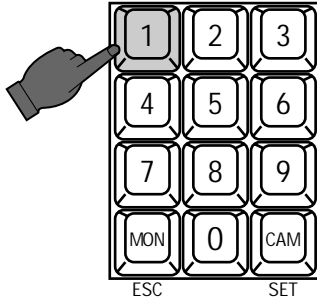

3. Press the **PRESET/AF** button to move the camera to the preset position on the active monitor.

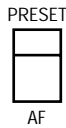

Note: To be able to use the above function, the preset position number must have been set for that camera.

● Pan/Tilt Control (Home Position)

The following function requires the use of cameras equipped with the specific feature.

1. Select the desired monitor and camera.
Refer to the Monitor Selection and Camera Selection.
2. Select the Cam-Preset (**D1**) Menu on the LCD display by pressing the appropriate Direction button.

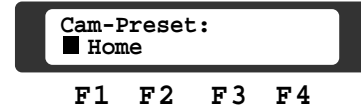

3. Press the Function (**F1**) button to move a camera to the Home Position.

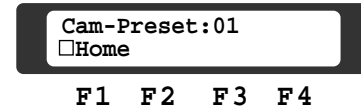
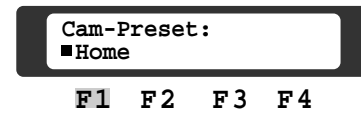

ON: Home
OFF: Home

Notes:

- Pressing the **AUX 1** button while the **ALT** indicator is on will move a camera to the home position without displaying the Cam-Preset Menu.
- To be able to use the above function, the home position must have been set for that camera.

● Pan/Tilt Control (Camera Position Operation)

The following function is available only when the Mode Selection Switch located on the rear of the controller is set to CAM-P Mode, and requires the use of cameras equipped with the specific feature.

1. Select the desired monitor.
Refer to the Monitor Selection.
2. Select the CAM-P (**D5**) Menu on the LCD display by pressing the Direction buttons.

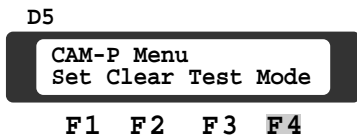

3. Press the Function (**F4**) button to display the menu shown below.

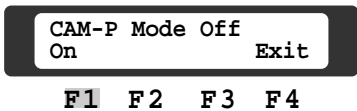

4. Select CAM-P Mode On by pressing the Function (**F1**) button repeatedly.

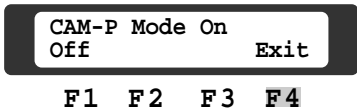

Note: Selecting On mode on the LCD display enables the **MON (ESC)** key to execute the selection. When selecting the monitor, enter the desired monitor number by pressing the Numeric keys, and then press the Function (**F1**) button instead of the **MON (ESC)** key while the Monitor Selection (**A1**) Menu is displayed.

5. Select the desired camera position number by pressing the Numeric keys, then press the **MON (ESC)** key to move the camera to the preset position. The selected camera position appears on the active monitor.

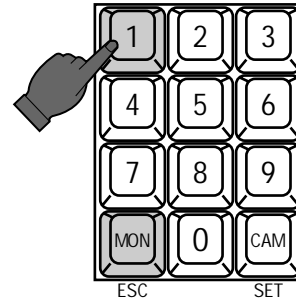

6. Press the Function (**F4**) button to return to the CAM-P Menu.

Note: To use the above functions, it is necessary to register the preset position number with the camera number.

Refer to the Mode Selection Switch Setting on page 52 and the Camera Position Number Setting on page 121 for further details.

● Pan/Tilt Control (Auto/Random Panning)

The functions described below require the use of the specified Pan/Tilt Head or camera equipped with the specific feature.

MODEL	AUTO-PAN	RANDOM-1	RANDOM-2
WV-BS200	○	Not available	○
WV-CS300	○	Not available	○
WV-CS400	○	Not available	Not available
WV-CS500	○	○	○
WV-CS600	○	Not available	Not available
WV-CS650	○	Not available	Not available
WV-CS850	○	Not available	Not available
WV-CS850A	○	Not available	Not available
WV-7220D	*○	*○	*○
WV-7225	*○	*○	*○
WV-7230D	*○	*○	*○
WV-7260D	*○	*○	*○

Notes:

*○: Function is available in combination with the WV-RC100, WV-RC150 or WV-RC170 Receiver.

Random-1: Auto Panning Head pans for a predetermined time, "X" (set by the receiver), stops for 2X, and continues in the same direction for "X" period, unless Pan Limit Switch is closed, in which case unit will pan in reverse direction for remainder of X time.

Random-2: Panning direction and time are almost impossible to predict.

1. Select the desired monitor and camera.
Refer to the Monitor Selection and Camera Selection.
2. Select the Pan Action (**B1**) Menu on the LCD display by pressing the Direction buttons.

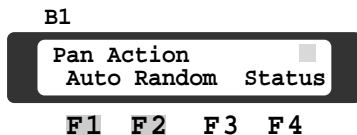

3. Pressing the Function (**F1**) button will toggle the Auto Panning function on and off.



On: **Auto**
Off: **Auto**

Note: Pressing the **AUX 2** button while the **ALT** indicator is on will toggle the Auto Panning function on and off without displaying the Pan Action Menu.

4. Pressing the Function (**F2**) button will toggle the Random Panning function on and off.



On: **Random**
Off: **Random**

5. Additionally the following panning functions are available when the camera with specified function is equipped in a system.

• Sort Mode

The camera operates in the sequence of preset positions counterclockwise from Pan/Tilt Starting Point. Select **2** by pressing the numeric key, and then press the Function (**F1**) button to toggle the sort mode on and off.

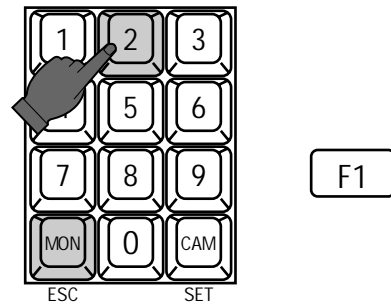

• Sequence Mode

The camera operates in the numerical order of preset positions. Select **3** by pressing the numeric key, and then press the Function (**F1**) button to toggle the sequence mode on and off.

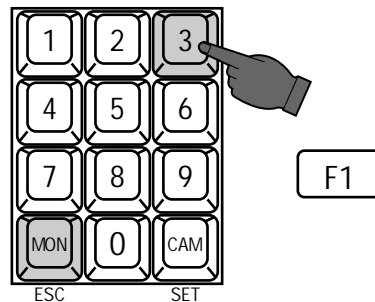

Note: To be able to use the above function, the preset position number must have been set for that camera.

● Direct Preset Setup

The following function requires the use of cameras equipped with the specific feature.

This function enables registering of preset position number without opening the camera setup menu.

1. Select the desired monitor and camera.
Refer to the Monitor Selection and Camera Selection.
2. Move the camera to the preset position by moving the Joystick Controller, and then adjust the lens zoom and focus.
3. Select the PrePOSI Setup **(B5)** Menu on the LCD display by pressing the Direction buttons.
4. Select the desired preset position number by pressing the Numeric keys, then press the Function **(F1)** button to register the position.

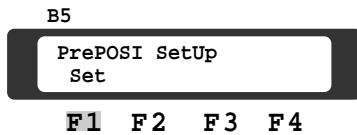
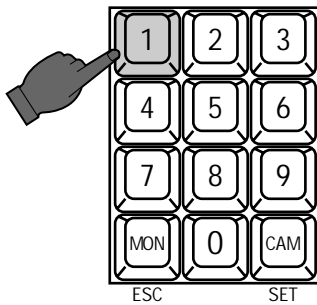

Note: If the position number entered has been registered previously, the old position will be overwritten by the new one.

● Patrol Learn and Play

The following function requires the use of cameras equipped with the specific feature.

A routine of manual operations can be stored for a specific time and later reproduced repetitively.

1. Select the desired monitor and camera.
Refer to the Monitor Selection and Camera Selection.
2. Select the Patrol Learn **(B4)** Menu on the LCD display by pressing the Direction buttons.

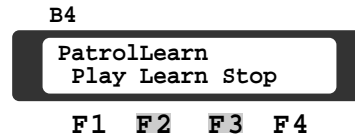

3. Press the Function **(F2)** button to start Patrol Learn .
"LEARNING" appears on the active monitor.
4. Operate the camera manually. Operations data is stored.
The stored data is as show below.
Pan/Tilt, Lens Iris, Focus, Zoom and Preset Position
5. Press the Function **(F3)** button to end the storage.

To reproduce the stored data, follow the procedure shown below.

1. Select the desired monitor and camera.
Refer to the Monitor Selection and Camera Selection.
2. Select the Patrol Learn **(B4)** Menu on the LCD display by pressing the Direction buttons.

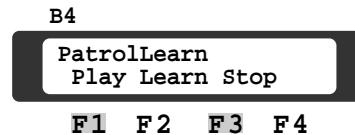

3. Press the Function **(F1)** button to reproduce the stored Patrol function.
4. Press the Function **(F3)** button to end the reproduction.

● Camera Power and Housing Control

For remote camera power operation, a 24 V AC powered camera must be installed in the housing.

1. Select the desired monitor and camera.
Refer to the Monitor Selection and Camera Selection.
2. Select the Cam-Power Housing (**B2**) Menu on the LCD display by pressing the Direction buttons.

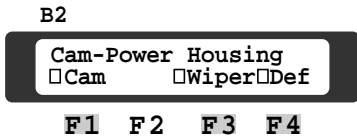

3. Press the Function (**F1**) button to toggle the camera power on and off.

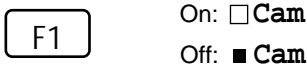

4. Press the Function (**F3**) button to toggle the housing wiper on and off.

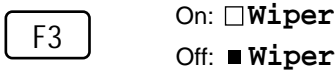

5. Press the Function (**F4**) button to toggle the housing defroster on and off.

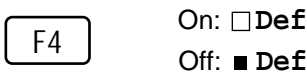

Caution

To prevent premature wearing of the wiper blades, be sure to turn off the wiper when it is not needed or before selecting another camera for viewing.

■ Running a Sequence

● Program Sequence

The following functions are available only if a Program Sequence has been previously established through the Set Up Menu.

As described on page 67, the Program Sequence can display up to 128 cameras in a predetermined series on a selected monitor.

1. Select the desired monitor.
Refer to the Monitor Selection.
2. Select **0** by pressing the Numeric key.

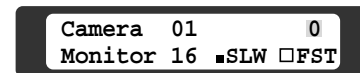
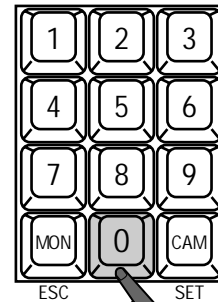
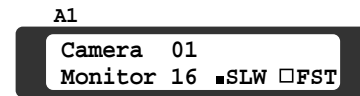

3. Press the **FORWARD SEQ** button to run the assigned Program Sequence in forward direction on the active monitor.

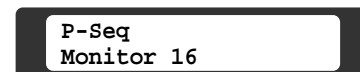
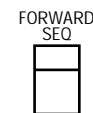

- 4. Press the **STOP** button to pause the sequence that is being run on the active monitor.

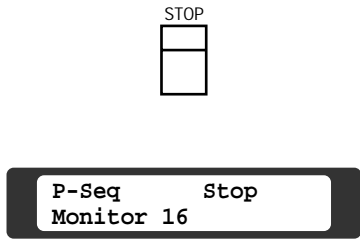

- 5. Press the **FORWARD SEQ** button to restart the sequence forward from the step that was previously paused by pressing the STOP button.

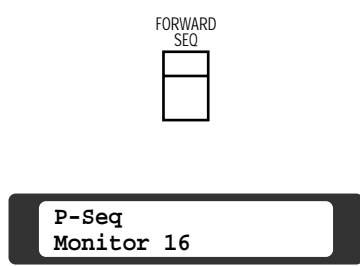

- 6. Press the **BACK SEQ** button to restart the sequence backward from the step that was previously paused by pressing the STOP button.

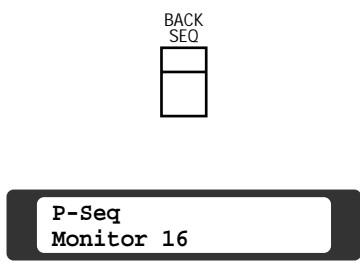

- 7. Press the **INC +1CAM** button to move the sequence one frame to the next step (in forward or reverse run direction) from the step that was previously paused by pressing the STOP button.

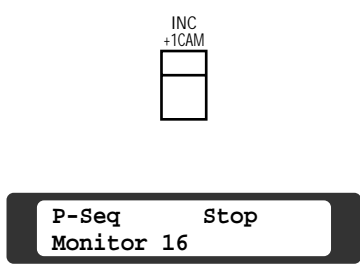

- 8. Press the **DEC -1CAM** button to move the sequence one frame to the previous step (in forward or reverse run direction) from the step that was previously paused by pressing the STOP button

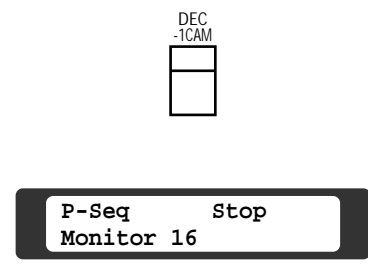

- 9. Press the **FORWARD SEQ** button while the **ALT** indicator is on to restart the sequence forward from the beginning of the sequence step that was previously paused by pressing the STOP button.

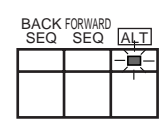

- 10. To return to Spot monitoring, select a camera. Refer to the Camera Selection.

● Tour Sequence

The following functions are available only if a Tour Sequence has been previously established through the Set Up Menu.

As described on page 68, any one of 32 tours can be assigned to any one of 16 monitors.

1. Select the desired monitor.
Refer to the Monitor Selection.
2. Select the desired Tour Sequence number by pressing the Numeric keys.

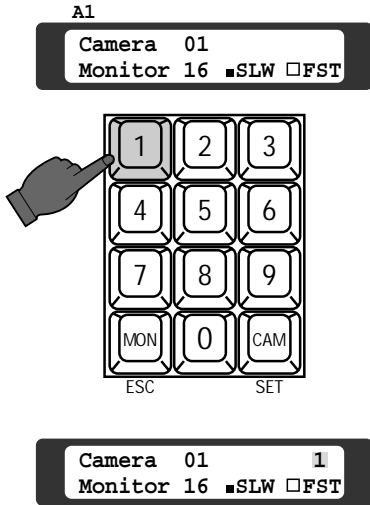

3. Press the **FORWARD SEQ** button to run the Tour Sequence in forward direction on the active monitor.

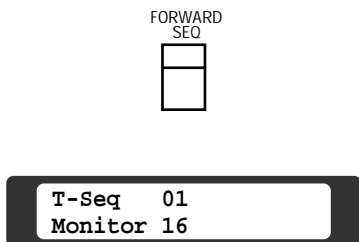

4. Press the **STOP** button to pause a Tour Sequence that is being run on the active monitor.

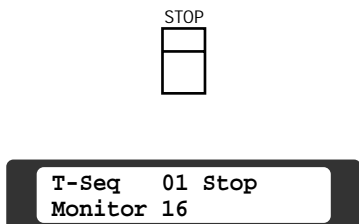

5. Press the **FORWARD SEQ** button to restart a Tour Sequence forward from the step that was previously paused by pressing the STOP button.

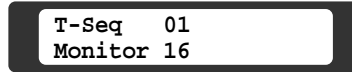

6. Press the **BACK SEQ** button to restart a Tour Sequence backward from the step that was previously paused by pressing the STOP button.

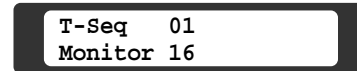

7. Press the **INC +1CAM** button to move the sequence one frame to the next step (in forward or reverse run direction) from the step that was previously paused by pressing the STOP button.

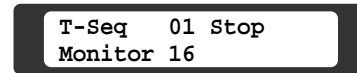
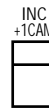

8. Press the **DEC -1CAM** button to move the sequence one frame to the previous step (in forward or reverse run direction) from the step that was previously paused by pressing the STOP button.

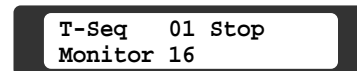
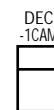

- Press the **FORWARD SEQ** button while the **ALT** indicator is on to restart the sequence forward from the beginning of the sequence step that was previously paused by pressing the STOP button.

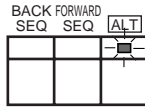

- To return to Spot monitoring, select a camera. Refer to the Camera Selection.

● Group Sequence

The following functions are available only if a Group Sequence has been previously established through the Set Up Menu.

As described on page 69, up to 8 Group Sequences can be set up.

- As described earlier, the Group Sequence determines which monitor is to be connected to which camera. Therefore, selecting a monitor is not required.
- Select G-seq (**A2**) Menu on the LCD display by pressing the Direction buttons.

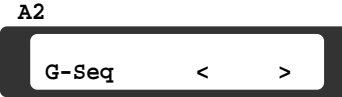

- Select the desired Group Sequence number by pressing the Function buttons (**F3/F4**) or the Numeric keys.

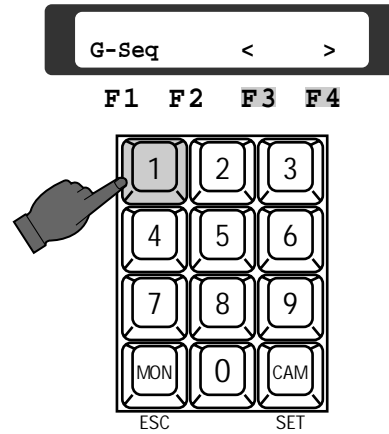

- Press the Function (**F1**) button to run a Group Sequence forward on the assigned monitors.

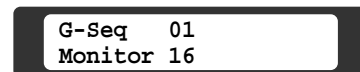

5. Press the **STOP** button to pause a Group Sequence that is being run on the assigned monitor.

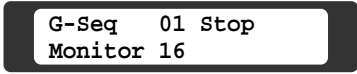

6. Press the **FORWARD SEQ** button to restart a Group Sequence forward from the step that was previously paused by pressing the STOP button.

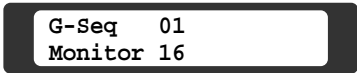

7. Press the **BACK SEQ** button to restart a Group Sequence backward from the step that was previously paused by pressing the STOP button.

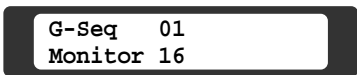
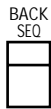

8. Press the **INC +1CAM** button to move the sequence one frame to the next step (in forward or reverse run direction) from the step that was previously paused by pressing the STOP button.

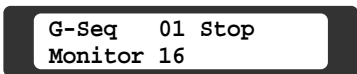

9. Press the **DEC -1CAM** button to move the sequence one frame to the previous step (in forward or reverse run direction) from the step that was previously paused by pressing the STOP button.

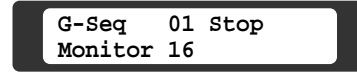
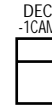

10. Press the **FORWARD SEQ** button while the **ALT** indicator is on to restart the sequence forward from the beginning of the sequence step that was previously paused by pressing the STOP button.

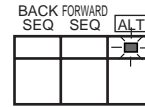

11. To return to Spot monitoring, select a camera. Refer to the Camera Selection.

■ Displaying Playback Video

If the VTR's Video Output is connected to the Monitor Input **(MONITOR IN)** Connector on the WV-PB5504AE Video Output Board, the VTR's video can be displayed on the monitor by the following procedures.

When this function is selected, the Camera Title, Date, and Time are not displayed on the active monitor.

1. Select the monitor connected to the Monitor Output **(MONITOR OUT)** Connector systemized with the connected VTR's Monitor Input **(MONITOR IN)** Connector. Refer to the Monitor Selection.

2. Press the **ALT** button (indicator is on), then press the **MON (ESC)** key.

The picture on the active monitor will be replaced by the video output connected to the Video Output Board. The display "in" appears on the LCD display as shown below.

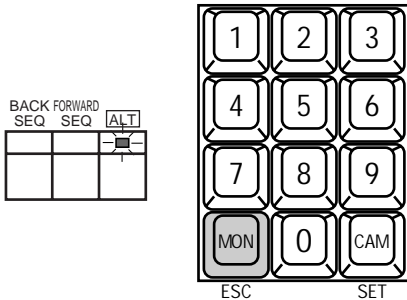

A1

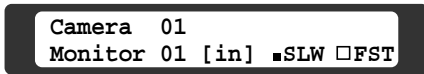

3. Press the **ALT** button again (indicator is off) to return to the original picture.

■ Title Display

1. Select the desired monitor and camera. Refer to the Monitor Selection and Camera Selection.
2. Select the Display **(A3)** Menu on the LCD display by pressing the Direction buttons.

A3

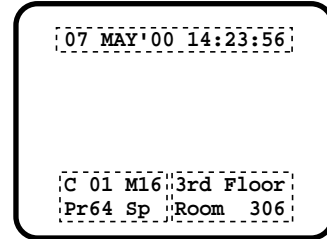
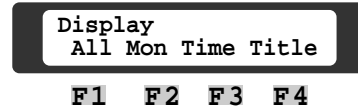

3. Press the Function **(F1)** button to toggle all items displayed on the active monitor on and off.

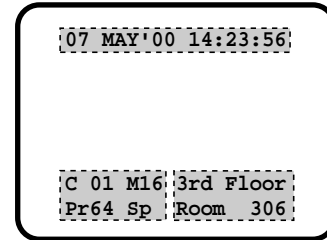

4. Press the Function **(F2)** button to toggle the monitor status display on the active monitor on and off.

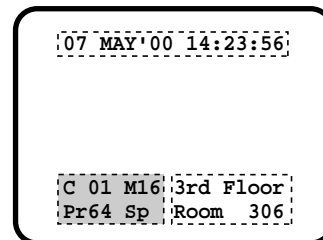

5. Press the Function (**F3**) button to toggle the date and time display on the active monitor on and off.

F3



6. Press the Function (**F4**) button to toggle the camera title display on the active monitor on and off.

F4

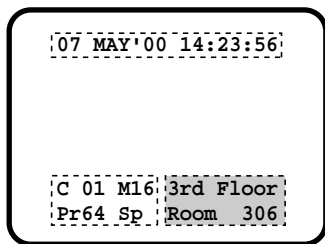

■ Camera Status Display

1. Select the desired monitor and camera. Refer to the Monitor Selection and Camera Selection.
2. Select the Pan Action (**B1**) Menu on the LCD display by pressing the appropriate Direction buttons.

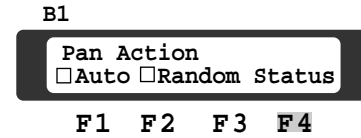

3. Press the Function (**F4**) button to toggle the camera status display shown below on and off.

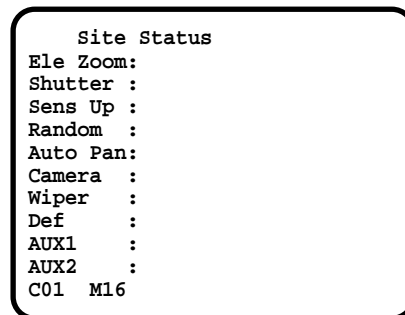

■ Camera Function Operation

● Electronic Shutter Mode

The following function requires the use of cameras equipped with the specific feature.

1. Select the desired monitor and camera.
Refer to the Monitor Selection and Camera Selection.
2. Select the Shutter (**C1**) Menu on the LCD display by pressing the appropriate Direction buttons.

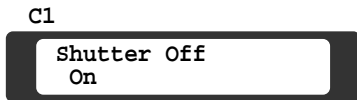

3. Select Shutter On mode by pressing the Function (**F1**) button.
Pressing the Function (**F3**) button will select slower shutter speeds, or pressing the Function (**F4**) button will select faster shutter speeds.

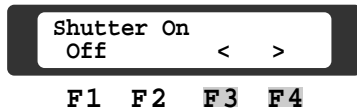
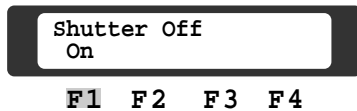

F3: 1/10 000 → 1/4 000 → 1/2 000 → 1/1 000 → 1/500
→ 1/250 → 1/120

F4: 1/120 → 1/200 → 1/400 → 1/1 000 → 1/2 000
→ 1/4 000 → 1/10 000

Note: The shutter speed varies by the selected cameras.

4. Press the Function (**F1**) button to turn the electronic shutter mode off.

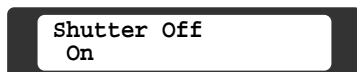
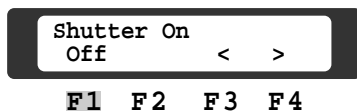

● Electronic Sensitivity Up Mode

The following function requires the use of cameras equipped with the specific feature.

1. Select the desired monitor and camera.
Refer to the Monitor Selection and Camera Selection.
2. Select the Sens Up (**C2**) Menu on the LCD display by pressing the appropriate Direction buttons.

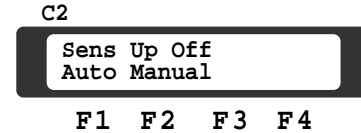

3. Press the Function (**F1**) button to toggle the Auto Sensitivity Up Mode on and off.

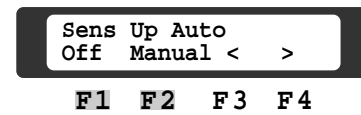
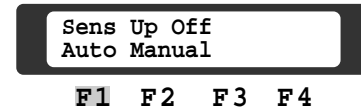

4. Press the Function (**F2**) button to toggle the Manual Sensitivity Up Mode on and off.

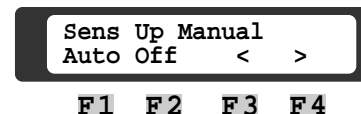
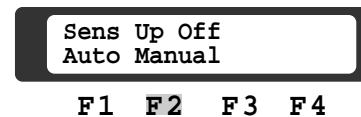

5. In the On mode, pressing the Function (**F3**) button will select a lower sensitivity setting, or pressing the Function (**F4**) button will select a higher sensitivity setting in the selected mode.

F3: X10 → X6 → X4 → X2 → X1

F4: X1 → X2 → X4 → X6 → X10

Note: The sensitivity varies by the selected cameras.

6. Press the Function (**F1**) button (or Function (**F2**) button) to turn the Sensitivity Up Mode off.

● Electronic Zoom Mode

The following function requires the use of cameras equipped with the specific feature.

a) Selecting Area after Zooming Procedures:

1. Select the desired monitor and camera.
Refer to the Monitor Selection and Camera Selection.
2. Select the Ele Zoom **(C3)** Menu on the LCD display by pressing the appropriate Direction buttons.

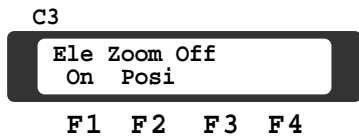

3. Select Ele Zoom On mode by pressing the Function **(F1)** button.
A Zoomed picture appears on the active monitor with the area that was last selected.

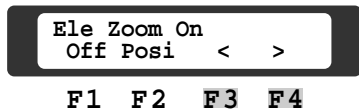
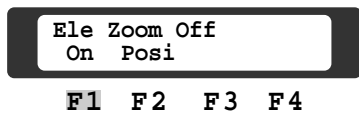

4. Press the Function **(F3 or F4)** button repeatedly to select the desired zoomed area.
The zoomed area is switched over as shown in the following table.

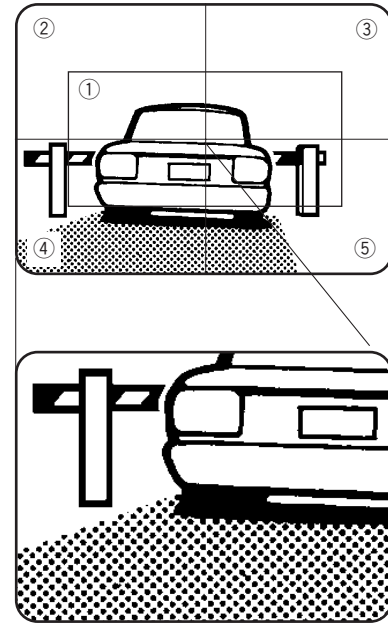

Key No.	Selected Area
F3	⑤ → ④ → ③ → ② → ①
F4	① → ② → ③ → ④ → ⑤

5. Press the Function **(F1)** button to turn the Electronic Zoom Mode off.

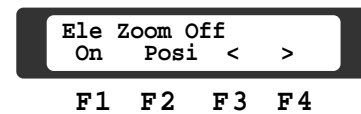
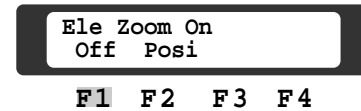

b) Selecting Area before Zooming Procedures:

1. Select the desired monitor and camera.
Refer to the Monitor Selection and Camera Selection.
2. Select the Ele Zoom (C3) Menu on the LCD display by pressing the appropriate Direction buttons.
3. Press the Function (F2) button to select the Zooming Position Mode.

C3
 Ele Zoom Off
 On Posi
 F1 F2 F3 F4

Ele Zoom Posi
 On Off < >
 F1 F2 F3 F4

4. Press the Function (F3 or F4) button repeatedly to select the desired zooming area.
The emphasized area is switched over on the monitor as shown in the previous table.
5. Press the Function (F1) button to select the Electronic Zoom Mode.
A zoomed picture of the area selected in step 4 above appears on the monitor.

Ele Zoom Posi
 On Off < >
 F1 F2 F3 F4

Ele Zoom On
 Off Posi < >
 F1 F2 F3 F4

6. Press the Function (F1) button to turn the Electronic Zoom Mode off.

Ele Zoom On
 Off Posi < >
 F1 F2 F3 F4

Ele zoom OFF
 ON Posi
 F1 F2 F3 F4

● Backlight Compensation (BLC) Mode

The following function requires the use of cameras equipped with the specific feature.

1. Select the desired Monitor and camera.
Refer to the Monitor Selection and Camera Selection.
2. Select the BLC (D2) Menu on the LCD display by pressing the appropriate Direction button.

D2
 BLC Off
 Auto Preset
 F1 F2 F3 F4

3. Press the Function (F1) button to toggle the Auto BLC Mode on and off.

BLC Off
 Auto Preset
 F1 F2 F3 F4

BLC Auto
 Off Preset
 F1 F2 F3 F4

4. Press the Function (F2) button to toggle the Preset BLC Mode on and off.

BLC Off
 Auto Preset
 F1 F2 F3 F4

BLC Preset
 Auto Off
 F1 F2 F3 F4

● Camera Setup

The following function requires the use of cameras equipped with the specific feature.

1. Select the desired monitor and camera.
Refer to the Monitor Selection and Camera Selection.
2. Select the Camera Set Up (**D4**) Menu on the LCD display by pressing the appropriate Direction button.

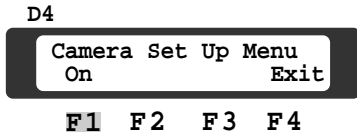

Note: The default setting for the Camera Setup Menu is On. Pressing the Function (**F1**) button at this moment will allow access to the Camera Set up menu if such access is authorized by the operator's level.

If "PROHIBITED" appears on the LCD display, press the **MON (ESC)** key to return the Camera Set Up Menu display.

3. Press the Function (**F1**) button to gain access to the Camera Set Up Menu.
The menu displayed may look as follows:

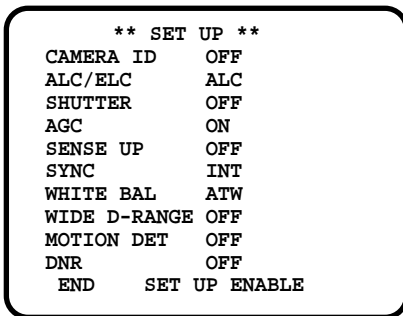
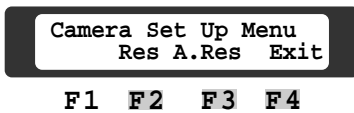

4. Select the desired item parameter by moving the Joystick Controller **^** and **v**, and then select the desired mode by moving the Joystick Controller **<** and **>**.

Press the **CAM (SET)** key to execute the setting or enter sub menu, and press the **MON (ESC)** key to escape from the setup mode or menu.

5. Press the Function (**F2**) button to reset the selected menu, or press the Function (**F3**) button to reset all settings to factory default setting.
6. Press the Function (**F4**) button to return to the original screen.

Notes:

- Refer to the Operating Instructions of the selected camera for further details.
- If camera setup is started with buttons on the camera, all settings must be made with the buttons on the camera's.
If camera setup is started with a Matrix Switcher, all settings must be made with the Matrix Switcher.

● Changing to Black and White Pictures

The following function is available only when specified cameras with colour-black and white switching feature are used.

1. Select the desired monitor and camera.
Refer to the Monitor Selection and Camera Selection.
2. Select the BW (**C4**) Menu on the LCD display by pressing the Direction buttons.

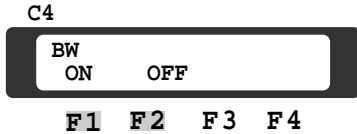

3. Press the Function (**F1**) button.
The picture will change from colour to black and white picture on the active monitor.
4. Press the Function (**F2**) button.
The black and white picture changes back to colour on the monitor.

Note: When the black and white parameter is set to AUTO in the camera setup menu, this function is disabled.

■ Auxiliary Control

The following function is available only when WV-RC100, WV-RC150 or WV-RC170 Receivers are included in the system.

1. Select the desired monitor and camera.
Refer to the Monitor Selection and Camera Selection.
2. Pressing the **AUX 1** or **2** button will toggle the user's auxiliary switch in the Receiver (WV-RC100, WV-RC150 or WV-RC170) on and off.

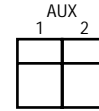

● Camera Function (Shortcut Function)

The following function is available only when specified cameras with the camera function feature is used. This function enables executing camera functions via a shortcut.

1. Select the desired monitor and camera.
Refer to the Monitor Selection and Camera Selection.
2. Select the Camera Function (**C5**) Menu on the LCD display by pressing the Direction buttons.

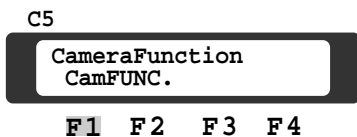

3. Select an assigned function number by pressing the Numeric keys, then press the Function (**F1**) button.
For example, enter 175 for AGC on.
The selected function will be executed on the active monitor.

Note: For further information, refer to the Operating Instructions for that camera.

■ Alarm Control

● Alarm Input Selection

The following settings enable or disable alarm inputs from the camera site or Alarm Board after the Alarm Mode Select item has been set in the Setup Menu.

1. Select the Alarm in **(A5)** Menu on the LCD display by pressing the appropriate Direction button.

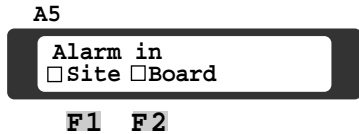

2. Press the Function **(F1)** button to toggle the Camera Site Alarm on and off.
3. Press the Function **(F2)** button to toggle the Interface Alarm (Alarm Board) on and off.

On: Site Board
Off: Site Board

● Alarm Operation

When an alarm is activated, the **ALARM** indicator on the controller blinks. The indicator keeps blinking until all alarms are cleared by pressing the **ACK RESET** button.



● To Cancel Alarm (Single Monitor)

1. The alarmed monitor(s) must first be selected. Refer to the Monitor Selection.
2. Press the **ACK RESET** button once for alarm acknowledgment. The LED indicator on the button blinks rapidly.
3. Press the **ACK RESET** button once again for alarm reset. The ALARM indicator goes off, and the LED indicator on the button goes off.

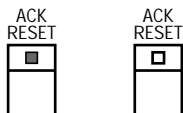

Note: "ALO" or "AL1" is displayed in the upper right corner of the alarmed monitor.

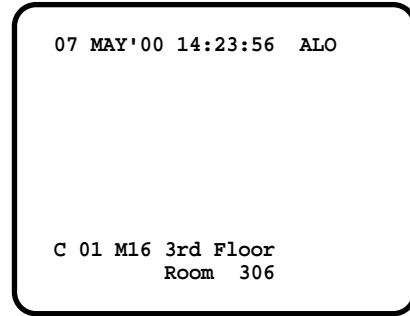

● To Cancel Alarm (Plural Monitors)

The following function is used to cancel alarm in a lump when Alarm Mode 1 or 2 is activated.

1. Select the alarmed monitor. Select Monitor 1 if Alarm Mode 1 is activated, or one of Monitors 1 - 4 if Alarm Mode 2 is activated.
2. Press the **ALT** button. The LED indicator on the button lights.
3. Press the **ACK RESET** button once for alarm acknowledgment. The LED indicator on the button blinks rapidly.
4. Press the **ACK RESET** button once again for alarm reset. The LED indicator on the button goes off.

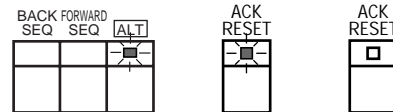

Note: Select one of the monitors that is running the Group Sequence by activating the Alarm Mode 3, then follow the steps above to cancel the alarmed monitors at once.

■ Preset Setting (WV-CS500 Only)

The following function is only available with the WV-CS500 camera that has preset panning functions.

● Preset Menu Setting

1. Select the desired monitor and camera.
Refer to the Monitor Selection and Camera Selection.
2. Select the Preset (**D3**) Menu on the LCD display by pressing the appropriate Direction buttons.

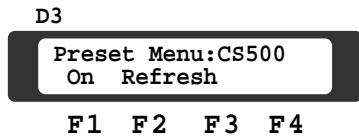

3. Press the Function (**F1**) button to select the Preset Program Mode.
The PRESET PROGRAM Menu appears on the active monitor.
Refer to the Preset Program Menu shown below.

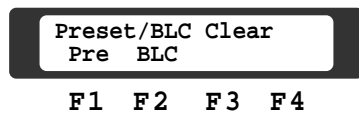
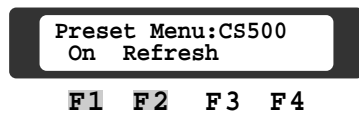

Press the Function (**F2**) button to select the Refresh Mode.
The Pan/Tilt/Zoom/Focus functions of the selected camera are automatically activated.

Note: Use the refresh mode if the preset positions become slightly different from the default positions.

● Preset Program Menu

As shown below, the Preset Program Menu has three sub-menus:
SET UP PRESET, SET HOME POSI (Position), and PRESET TEST.

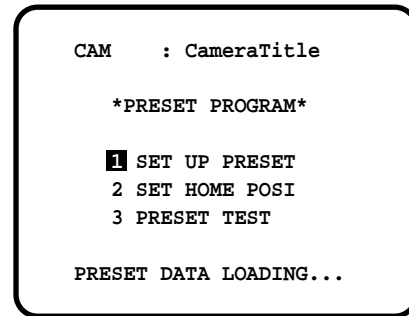

The menu items explained below.

1. SET UP PRESET
Sets up the preset position or preset BLC (Backlight Compensation) for the camera.
2. SET HOME POSI
Sets up the Home Position for the camera
3. PRESET TEST
Tests all selected preset positions.

To select an item from the Preset Program Menu:

1. Move the cursor to the desired item by moving the Joystick Controller.
2. To execute the selection, press the **CAM (SET)** key.
The selected item appears on the monitor.
3. To escape from the menu without changing any settings, press the **MON (ESC)** key.

● Setting Up Preset Positions

In the PRESET PROGRAM menu, select SET UP PRESET, and then press the **CAM (SET)** key. The PRESET NUMBER SET table shown below appears on the active monitor.

CAM : CameraTitle			
PRESET NUMBER SET			
1#	2#	3#	4#
5#	6#	7#	8#
9#	10#	11#	12#
13#	14#	15#H	16#
17	18	19	20#
21	22	23	24
25	26	27	28
29	30	31	32

1. Move the cursor to the desired preset number by moving the Joystick Controller.
2. Press the **CAM (SET)** key. The Preset Position Setting table shown below appears on the monitor.

CAM : CameraTitle	
POSITION NUMBER : 12	
PAN/TILT/ZOOM/FOCUS	
SET UP POSITION	

3. Move the camera to the preset position to be registered by moving the Joystick Controller, and adjust the zoom and focus by pressing the **ZOOM TELE/WIDE** and **FOCUS NEAR/ FAR** Control.
4. When satisfied with the position, press the **CAM (SET)** key.
The Preset BLC (Backlight Compensation) Setting table shown below appears on the monitor.

5. Move the cursor to the area, where backlight is bright, by moving the Joystick Controller.
6. Press the **INC +1CAM** button or **DEC -1CAM** button to toggle a mask on and off.
7. Repeat the above procedures until mask setting is completed.
8. Press the **CAM (SET)** key to execute the setting.
The monitor screen returns to the previous PRESET NUMBER SET table.
9. Repeat the above procedures to register positions for other preset numbers.
10. Press the **MON (ESC)** key to return to the previous Preset Program Menu.

● Home Position Setting

In the PRESET PROGRAM menu, select SET HOME POSI, and then press the **CAM (SET)** key. The HOME POSITION table shown below appears on the active monitor.

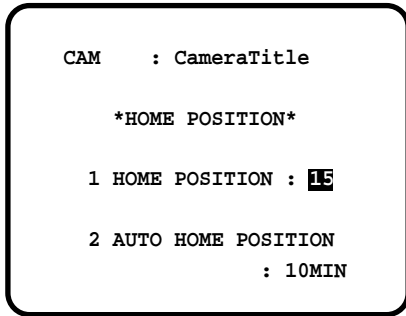

1. Move the cursor to the HOME POSITION parameter by moving the Joystick Controller, then select the desired position number by pressing the Numeric keys.
2. Move the cursor to the AUTO HOME POSITION parameter by moving the Joystick Controller, then select either mode Off or a desired time by pressing the **INC +1CAM** button or **DEC -1CAM** button.
3. Press the **CAM (SET)** key to execute the selection and return to the previous Preset Program Menu.

Note: When the auto home position function is enabled a camera will move to the designated home position automatically after a predetermined period of time.

● Preset Test Mode

In the PRESET PROGRAM menu, select PRESET TEST, and then press the **CAM (SET)** key. The table shown below appears on the active monitor.

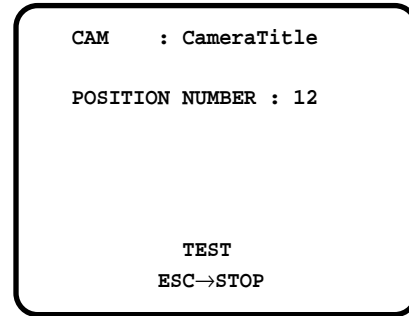

1. Press the **CAM (SET)** key to activate the test mode. The selected camera moves to all preset positions, proceeding from the lowest preset number to the highest. The above function will automatically end after ten minutes.
2. Press the **MON (ESC)** key to escape from the preset test mode.
3. Press the **MON (ESC)** key again to return to the previous Preset Program Menu.

● Clearing Preset Settings

1. Select the desired monitor and camera.
Refer to the Monitor Selection and camera Selection.
2. Select the Preset (**D3**) Menu on the LCD display by pressing the appropriate Direction buttons.

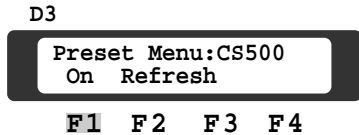

3. Press the Function (**F1**) button to select the Preset Program Mode.
The Preset Program Menu is displayed on the active monitor, and the LCD display reads as shown below.
4. Move the cursor to SET UP PRESET by moving the Joystick Controller, then press the **CAM (SET)** key.
The PRESET NUMBER SET table appears on the active monitor.
5. Move the cursor to the desired preset number by moving the Joystick Controller, then press the **CAM (SET)** key to select the Preset Position Setting table shown below.

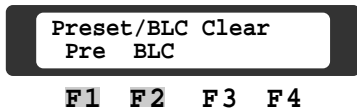
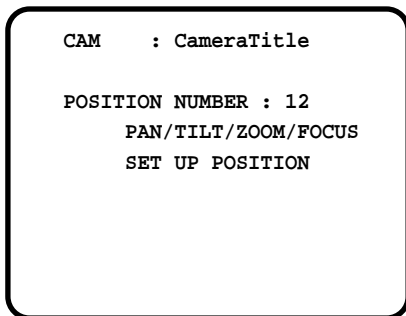

6. Press the Function (**F1**) button to clear the presets for the selected position number.
To clear only the BLC setting, press the Set **CAM (SET)** key to select the Preset BLC Setting table, and then press the Function (**F2**) button instead of (**F1**).
7. Pressing the **MON (ESC)** key repeatedly will return to the previous setup table or menu.

■ Camera Position Number Setting

The following function is available only when the Mode Selection Switch located on the rear of the controller is set to CAM-P Mode, and cameras equipped with the specific feature are used.

Refer to the Mode Selection on page 52.

● Register Camera Position Number

1. Select the desired monitor.
Refer to the Monitor Selection.
2. Select the CAM-P (**D5**) Menu on the LCD display by pressing the appropriate Direction button.

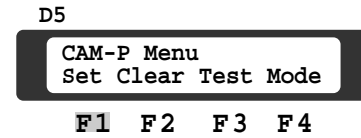

3. Pressing the Function (**F1**) button will display the menu shown below on the LCD display.
Select the camera number by pressing the Numeric keys, then press the **CAM (SET)** key.

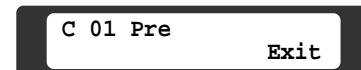

4. Select the preset position number by pressing the Numeric keys, then press the **CAM (SET)** key.
The picture at the selected camera preset position appears on the active monitor, and the LCD display reads as shown below.

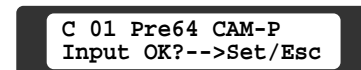

- Select the Camera Position Number by pressing the Numeric keys.
After completing the above steps, press the **CAM (SET)** key to execute the selection.
If a mistake was made in the above steps, press the **MON (ESC)** key to cancel the selection.



Note: Up to 1 000 positions can be registered on this menu.
If an attempt is made to register more than 1 000 positions, "Data Full" appears on the LCD display.

- Repeat the above steps for other camera positions.
When satisfied with all positions, press the Function (**F4**) button to exit from the programming mode.

● Delete Camera Position Number

- Select the desired monitor.
Refer to the Monitor Selection.
- Select the CAM-P (**D5**) Menu shown below on the LCD display by pressing the appropriate Direction buttons.

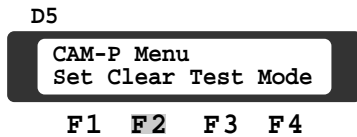

- Pressing the Function (**F2**) button will display the menu shown below on the LCD display.

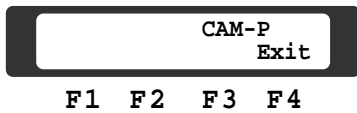

- Enter the camera position number to be deleted by pressing the Numeric keys, and then press the **CAM (SET)** key. The picture at the selected camera position appears on the active monitor, and the LCD display reads as shown below.

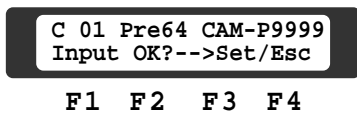

- Confirm the display on the LCD display, then press the **CAM (SET)** key to delete the selected Camera Position Number.
If a mistake was made in the above steps, press the **MON (ESC)** key to cancel the selection.
- Repeat the above steps for other camera position numbers.
When satisfied with all positions, press the Function (**F4**) button to exit from the programming mode.

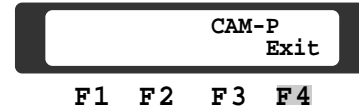

● Camera Position Test Mode

- Select the desired monitor.
Refer to the Monitor Selection.
- Select the CAM-P (**D5**) Menu shown below on the LCD display by pressing the appropriate Direction button.

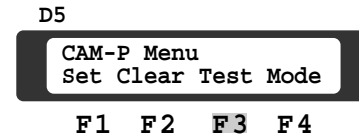

- Pressing the Function (**F3**) button will display the menu shown below on the LCD display.

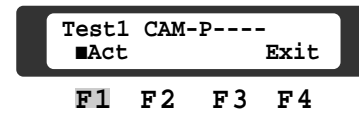

- Press the Function (**F1**) button to toggle the test mode on and off.
If On mode is selected, the picture at each of the selected camera positions is displayed on the active monitor at intervals of 3 seconds, proceeding from the lowest camera position number to the highest.

On: Act
Off: Act

- The test function stops automatically, and the LCD display reads as shown below.
Press the Function **(F4)** button to exit from the test mode. The display will return to the previous CAM-P Menu.

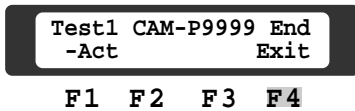

● Camera Position Mode Selection

Operation by camera position number is available only when CAM-P Mode is set to On mode.

- Select the CAM-P **(D5)** Menu shown below on the LCD display by pressing the appropriate Direction button.

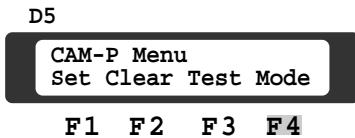

- Pressing the Function **(F4)** button will display the menu shown below on the LCD display.

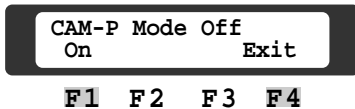

Press the Function **(F1)** button to toggle the mode on and off.

- Press the Function **(F4)** button to exit from the setup mode. The display will return to the previous CAM-P Menu.

Note: Selecting On mode on the LCD display enables the **MON (ESC)** key to execute the selection. When selecting the monitor, enter the desired monitor number by pressing the Numeric keys, and then press the Function **(F1)** button instead of the **MON (ESC)** key while the Monitor Selection **(A1)** Menu is displayed.

■ Priority Lock

This function is used by an operator to retain control of a monitor, even after that operator has selected another monitor or has logged out.

- Select the Priority Lock **(A4)** Menu on the LCD display by pressing the appropriate Direction button.
- Press the Function **(F1)** button to select the Priority Lock mode on the active monitor.
The monitor number is inversely displayed on the active monitor, as shown below.

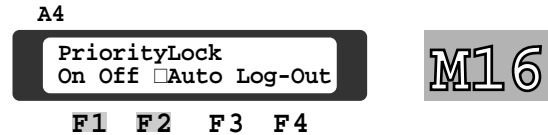

- Press the Function **(F2)** button to release the priority lock.
The monitor number is displayed normally on the monitor.

Note: This function will prevent operators with a lower priority from gaining control of a monitor. However, higher priority operators may still gain control of that monitor.

■ Log-Out

This function is used when an operator is leaving the controller, or no longer requires access to the system.

1. Select the Log-Out (**A4**) Menu by pressing the appropriate Direction button.
2. Press the Function (**F4**) button to log out. The LCD display shows the Log-in Display.

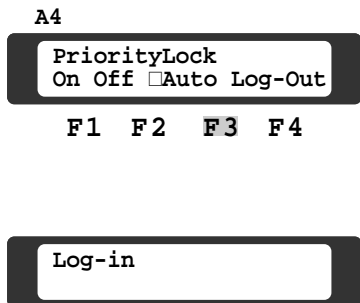

• Auto Log-in Setting

If the Auto Log-in setting is set to On mode, any operator can Log-in automatically as any operators previously. The auto log-in function may not work, if a previous operator has not logged out properly

Select On or Off mode to meet system requirements.

1. Select the Log-Out (**A4**) Menu by pressing the appropriate Direction buttons.

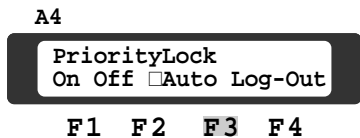

2. Press the Function (**F3**) button to toggle the Auto Log-in On and Off mode.

On: Auto
Off: Auto

SECTION 6

TROUBLESHOOTING

TROUBLESHOOTING

A majority of the problems encountered in operating a matrix switcher can be traced to incorrect hardware or software setup. Therefore, please read this section to see if your problem has a simple solution before requesting service.

● Initialization Problems

Symptom: Matrix Switcher will not power up.

1. Check the AC power cord connection with the AC outlet.
2. Check the fuse, located in the fuse holder in the rear of the WJ-SX550C Matrix Switcher.

Symptom: System Controller(s) will not power up.

1. Check the AC power cord connection with the AC outlet.
2. Check that the ON/OFF switch, located in the rear of the WV-CU550CJ System Controller, is turned on.

Symptom: System Controller(s) will not log-in.

1. Ensure that the System Controller(s) is (are) plugged into the correct ports on the Control Board of the WJ-SX550C Matrix Switcher. The two ports labeled "Test" do not support System Controller inputs.
2. If not using the factory supplied data cable assembly, make sure that the distance from the Control Board to the System Controller does not exceed the maximum recommended distance. Check that the proper grade of data cable is installed. Also, check that the correct wiring sequences are maintained at all cable installed. Also, check that the correct wiring sequences are maintained at all cable splices, junctions and connectors.

● Operational Problems

Symptom: Video from a specific camera cannot be displayed on a specific monitor.

1. If the camera cannot be displayed on any monitor, check the Operator Registration table and make sure that the operator is authorized access to the camera in question.
2. If a monitor cannot display any camera selected, check the Controller Table and make sure that controller can control the output of the monitor.
3. Check if the monitor has a Priority Lock set by another operator.
4. If the camera can be displayed on another monitor there may be a problem with the Video Output Board, call qualified service personnel.

Symptom: No Pan/Tilt/Zoom control of a camera.

1. If the prompt field "PROHIBITED" appears on the LCD display of the System Controller this indicates that the operator is not authorized access to the Pan/Tilt/Zoom functions for that camera. If needed, change the Operator Registration table programming for that operator.

Symptom: Can't run a Program Sequence.

1. Check that the level of the operator allows access to running a Program Sequence.
2. Make sure that a Program Sequence has been programmed to run on that monitor.

Symptom: Camera does not reach the designated preset position and the preset number is not displayed on the monitor, even though the preset position setting is specified in the Tour or Group Sequence programming.

1. The programmed Dwell Time in the Tour or Group Sequence is not sufficiently long enough to allow the preset position to be reached. Increase the Dwell Time.

Symptom: The Sequences (Program, Tour, Group) will not run at all or will not run properly, with respect to the Dwell Time set, on a specific monitor.

1. Check in the External Timing Select Table if the monitor has EXT TIMING ON selected. If so, the dwell time of the monitor is synchronized with time lapse mode set in the associated Time Lapse VTR.

Symptom: The Preset Test stops after one minute with the WV-CS500 Combination Camera

1. Make sure that the Control Site Mode Selection Switch (SW2) is set to the Multi-Site Mode On position.

Symptom: While running the Preset Test, the WV-CS500 Combination Camera stops at preset positions for extended periods of time.

1. If the WV-CS500 had preset positions originally programmed by the other System, there are dwell times associated with those positions that will determine how long the Preset Test will take.
Re-program the presets by using the Matrix Switcher to eliminate the dwell times.

Symptom: The Timer Event mode will not activate.

1. The Timer Event is defined in this system as Operator 00. Initially, the priority of operator 00 is set to 30 at the factory (the lowest priority). If another operator with a higher priority is currently operating the desired devices, the Timer Event will not occur (however, a backslash symbol “/” with either a Tour or Group Sequence number will appear in the upper-right corner of the monitor screen, for example: /T02). Increase the priority of operator 00 through use of the Operator Registration Table to enable the Timer Event.
2. If a Special Day Schedule is programmed, make sure that the month, day, and year are all filled out.
3. The order of priority for days of the week and special days is: Special Day has a higher priority than a regular day. Also, a Special Day entered in the Special Day Schedule Table before another Special Day is entered has a higher priority.

Symptom: The printer will not stop printing even though the Escape MON (ESC) key is pressed.

1. The characters that are already sent to the buffer in the printer will be printed out, regardless of the **MON (ESC)** key being pressed. This is normal.

Symptom: PROHIBIT appears on the LCD display.

1. The function attempted is not allowed because of the operator's level or there is operator's lockout of camera video and/or Pan/Tilt Control. Press the **MON (ESC)** key to clear the display. Change the operator's level and/or video lockout setup.

Symptom: WARNING! PROHIBITED! appears on the monitor screen.

1. The System Controller is not allowed to access a particular monitor due to Keyboard/Monitor partitioning. Change Keyboard/Monitor partitioning in the Set Up Menu.

Symptom: When Log-in is attempted, “No Entry” appears on the LCD display.

1. An incorrect password or operator number is used during log-in. Use the correct password and operator number.

Symptom: When Log-in is attempted, “Monitor Busy” appears on the LCD display.

1. All monitors are currently being used by an operator or event with a higher priority than this operator. Either change the priority of the operator to an equal or higher priority or wait for the current operator or event to complete their use of the monitors.

Symptom: “Monitor (#) Busy” appears on the LCD display and the Busy LED also lights.

1. Another operator with greater priority is using that monitor. Wait until higher priority operator releases the monitor.
2. Another operator with equal priority has taken control over that monitor. Re-take control from that operator.

Symptom: “Camera (#) Busy” appears on the LCD display and the Busy LED also lights.

1. Another operator with greater priority is using that camera. Wait until higher priority operator releases the camera.
2. Another operator with equal priority has taken control over that camera. Re-take control from that operator.

Symptom: The Busy LED lights up.

1. All monitors are busy. Wait until event or operator releases control over all monitors.

Symptom: “NOT AVAILABLE” appears on the LCD display.

1. A Priority Lock is in effect for that monitor. Select another monitor.

Symptom: The Alarm LED lights up.

1. An alarm has been received. To clear the alarm, first select the alarmed monitor, acknowledge the alarm with the **ACK RESET** button. Then, clear the alarm by again pressing the **ACK RESET** button or wait until the Auto Reset function clears the alarm after a predetermined amount of time has passed.

Symptom: The Alarm does not work.

1. Check that the Alarm Mode is set to "Mode 1 - 3" or Timer on the Alarm Mode Select Menu of the Setup Menu.
2. Check that the Alarm Input (Site or Board) is set to "On" on the Alarm Mode Select Menu of the Setup Menu.

Symptom: The sequence does not stop after the programmed time.

1. A timer activated sequence will continue beyond the stop time until the next automatic or manual operation is performed.

Symptom: The Group Sequence does not run to synchronized on the monitors that is made the EXT Timing setting from the connected VTR.

1. A Group Sequence synchronizes with the EXT Timing on a lowest number of monitor that is assigned to run the sequence of group monitors.

Symptom: Can't operate the cameras by the Camera Position Numbers.

1. Check that the CAM-P Mode is set to "On" mode in the CAM-P Menu on the LCD display.
2. Check that the Camera Position Numbers are registered correctly by using the Camera Position Test Mode in the CAM-P Menu on the LCD display.

SECTION 7
SPECIFICATIONS

SPECIFICATIONS

■ WJ-SX550C Matrix Switcher

General

Power Supply:	220 - 240 V AC 50 Hz
Power Consumption:	Approx. 20 W (Max. 75 W with all optional boards installed)
Max. Number of Video Input Boards:	8 (total 64 Inputs)
Max. Number of Video Output Boards:	4 (total 16 Outputs)
Max. Number of Alarm Boards:	1 (total 64 alarm Inputs)
Max. Number of System Controllers:	8 (WV-CU550CJ)
RS-232C:	25-pin D-Sub Connector
Printer:	25-pin D-Sub Connector
Time Adjust In (for VTR):	2-pin Pair-Cable
VD/VS In/Out:	2 (BNC)
VD Out:	Video Level 4 V[p-p]/75 Ω (BNC)

Camera Switching

Dwell Time:	Min. 1 second/max. 30 seconds
Max. Number of Sequences:	16 Program Sequences (1 program/monitor) 32 Tour Sequences (any monitors) 8 Group Sequences (any monitors)
Number of Programming Steps:	64

Time Event Program

Time Events (Start & Stop):	45/day
Formats of Time Event Program:	Day of week + 5 special days

Alarm Program

Max. Number of Alarm Inputs:	64
Max. Number of Alarm Recalls:	99
Alarm Activations:	Mode-1: Any alarms to 1 monitor Mode-2: Any alarms to 4 monitors Mode-3: Any alarms to any monitors (max. 110 patterns)
Time Alarms (Start & Stop):	10/day
Formats of Time Alarm Program:	Day of week + 5 special days

Operator Setup

Max. Operator Registrations:	30 operators with 5 digits, password and priority
Operator Access Levels:	5 levels
Ambient Operating Temperature:	-10°C - +50°C (14°F - 122°F)
Ambient Operating Humidity:	Less than 90 %
Dimensions:	480 mm (W) x 265 mm (H) x 371 mm (D) 18-7/8" (W) x 10-7/16" (H) x 14-5/8" (D)
Weight:	13.5 kg (29.7 lbs.)
Option:	Blank Panel WV-Q63E

■ WV-PB5508E Video Input Board

Camera Input (1 - 8):	1.0 V[p-p]/75 Ω composite video signal 0.5 V[p-p]/75 Ω data signal and 2.5 V[p-p]/75 Ω vertical timing pulse multiplexed
Video Output (1 - 2):	1.0 V[p-p]/75 Ω composite video signal 9-pin D-Sub Connector
Functions:	Camera Site Control: All Inputs Cable Compensation: S, M, L (Short, Middle, Long) Vertical Drive (VD2) Output: On/Off Control Data Output: On/Off
Dimensions:	24.5 mm (W) x 265 mm (H) x 260 mm (D) 15/16" (W) x 10-7/16" (H) x 10-1/4" (D)
Weight:	450 g (1.0 lbs.)
Option:	Loop-Through Cable WV-CA64

■ WV-PB5504AE Video Output Board

Monitor Output (1 - 4):	1.0 V[p-p]/75 Ω composite video signal
Monitor Input (1 - 4):	1.0 V[p-p]/75 Ω composite video signal
Alarm Output (1 - 4):	Open collector output: 16 V DC 100 mA max.
Reset Output (1 - 4):	Pulse (VTR): +5 V DC 500 ms or Open collector output: 16 V DC 100 mA max.
External Timing Input (1 - 4):	Pulse 5 V[p-p] interval time more than one second
Recover Input (1 - 4) :	Make Contact or Open collector Input Contact time more than 0.5 second Interval time more than two seconds
Character Generator:	Camera ID; 30 characters (15 x 2 lines) Character Style; White with Black Border Black with White Border
Dimensions:	24.5 mm (W) x 265 mm (H) x 260 mm (D) 15/16" (W) x 10-7/16" (H) x 10-1/4" (D)
Weight:	400 g (0.9 lbs.)

■ WV-PB5564E Alarm Board

Alarm Input (1 - 64):	Normally open or normally closed selectable (contact time more than 100 ms.) 37-pin D-Sub connector (x2)
Dimensions:	24.5 mm (W) x 265 mm (H) x 260 mm (D) 15/16" (W) x 10-7/16" (H) x 10-1/4" (D)
Weight:	400 g (0.9 lbs.)

■ WV-CU550CJ System Controller

Power Supply :	220-240 V AC 50 Hz
Power Consumption :	Approx. 5 W
Data Input/Output :	6-conductor Modular Jack (RS-485, 4 Lines)
Switching Functions :	Program Sequence/Tour Sequence Group Sequence/Backward Sequence Forward Sequence/Inc Dec
Camera Functions :	Electronic Shutter : On/Off, Shutter Speed Select Electronic Sensitivity Up Mode Select : Auto/Manual/Off Electronic Zoom : On/Off, Zoom Position : Area Select Backlight Compensation : Auto/Preset/Off
Lens Functions :	Iris: Open/Close/Preset (only with DC control lens) Focus : Near/Far Zoom : Tele/Wide Auto Focus: Activate
Housing :	Wiper :On/Off, Defroster : On/Off, Camera : On/Off
Pan/Tilt :	Manual Pan : Right/Left, Manual Tilt : Up/Down Auto Pan : On/off, Random Pan : On/Off, Preset, Home AUX 1-2 : On/Off
Auxiliary Switch :	
Unit Number :	1 - 8
Ambient Operating Temperature :	-10°C - +50°C (14°F - 122°F)
Ambient Operating Humidity :	Less than 90 %
Dimensions :	370 mm (W) x 129 mm (H) x 221 mm (D) 14-9/16" (W) x 5-1/8" (H) x 8-11/16" (D)
Weight :	2.2 kg (4.8 lbs.)

■ WV-PB5548E Data Board

Data Input/Output (1 - 8):	RS-485 (Full Duplex or Half Duplex, selectable by internal switch) [5-pin T(A), T(B), R(A), R(B), GND] X8 use with shielded, twisted pair data cable Transmitting Speed (Baud Rate); 1 200 - 19 200 bps
Max. Cable Length:	1 200 m (4 000 ft)
Max. Number of Boards:	8 (Address 1 - 8, Total 1 - 64 Data Input/Output)
Dimensions:	24.5 mm (W) x 265 mm (H) x 260 mm (D) 15/16" (W) x 10-7/16" (H) x 10-1/4" (D)
Weight:	400 g (0.9 lbs.)

■ WV-Q62E Rack Mount Bracket

Dimensions:	90 mm (W) x 177 mm (H) x 30 mm (D) 3-9/16" (W) x 6-15/16" (H) x 1-3/16" (D)
Weight:	720 g (1.6 lbs.)

■ WV-Q63E Blank Panel

Dimensions:	25.4 mm (W) x 263 mm (H) x 6 mm (D) 1" (W) x 10-3/8" (H) x 1/4" (D)
Weight:	50 g (0.1 lbs.)

Weight and dimensions shown are approximate.
Specifications are subject to change without notice.

Matsushita Electric Industrial Co., Ltd.

Web Site : <http://www.panasonic.co.jp/global/>

N0901-2042 V8QA5860CN
Ⓝ 19

Printed in Japan
Gedruckt in Japan
Imprimé au Japon