

WL2815

Low power consumption, CMOS LDO

[Http://www.sh-willsemi.com](http://www.sh-willsemi.com)

Descriptions

The WL2815 series are low dropout linear regulators and optimized to provide a high performance solution for battery power system to deliver low quiescent current. The devices offer a new level of cost effective performance in cellular phones, laptop and notebook computers, and other portable devices.

The WL2815 series are designed to make use of low cost ceramic capacitors which ensure the stability of the output current, and enhance the efficiency in order to prolong the battery life of those portable devices.

The WL2815 regulators are available in DFN1x1-4L packages. Standard products are Pb-free and Halogen free products.



DFN1X1-4L

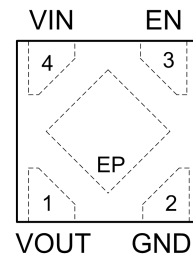

Features

- Quiescent current : 1.5 μ A Typ.
- Input voltage : 2.1V ~ 5.5V
- Output voltage : 1.1V ~ 3.3V
- Output current : 300mA @ $V_{OUT}=3.3V$
- Output current : 200mA @ $V_{OUT}=2.0V$
- Output current : 150mA @ $V_{OUT}=1.5V$
- Dropout voltage : 100mV @ 100mA
- Recommend capacitor : 1 μ F or more
- Operating Temperature : -40 ~ +85 °C
- Output short protection

Applications

- MP3/MP4 Players
- Cell phones
- Bluetooth earphone
- Wireless mouse
- Others electronics devices

Pin Configuration (Top View)

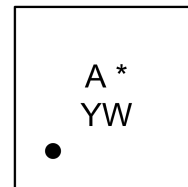

A: Device Code
*** : Voltage Code**
Y : Year Code
W: Week Code

For detail marking information, please see page 7.

Marking

For detail order information, please see page 8.

Order Information

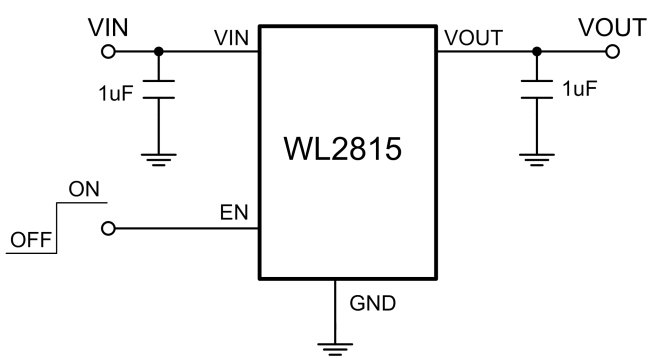
Typical Application
Pin Description

DFN1X1-4L

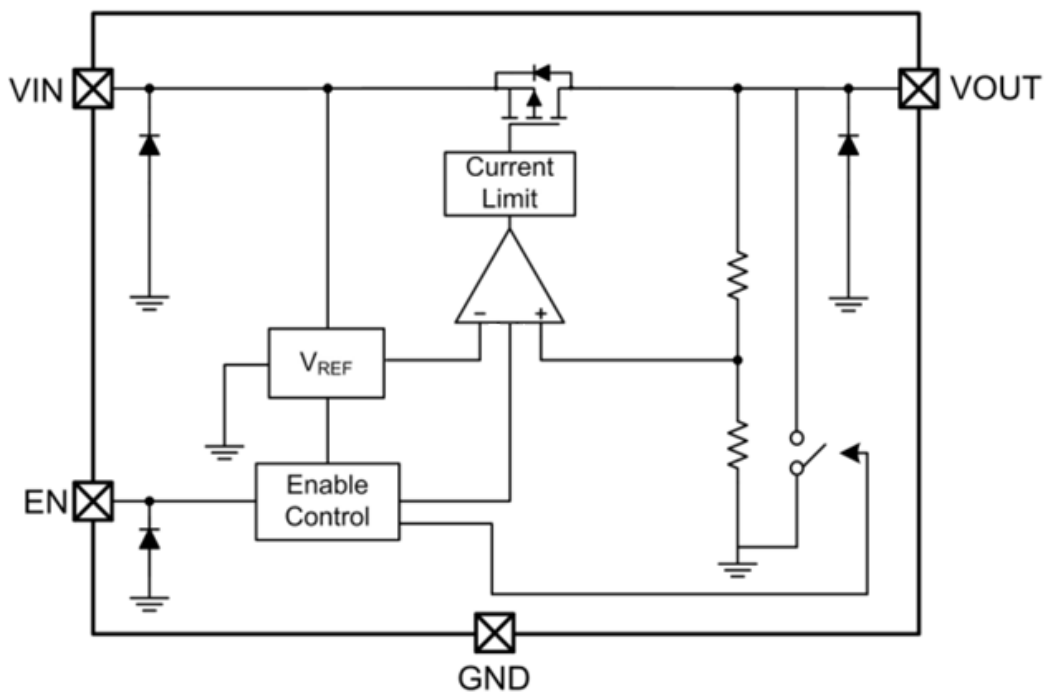
PIN	Symbol	Description
1	VOUT	Output
2	GND	Ground
3	EN	Enable (Active high, not floating)
4	VIN	Input
EP		GND level, this pin must connect to GND.

Block Diagram

Absolute Maximum Ratings

Parameter	Value	Unit
Power Dissipation	400	mW
V _{IN} Range	-0.3~6.5	V
V _{EN} Range	-0.3~V _{IN}	V
V _{OUT} Range	-0.3~V _{IN}	V
Lead Temperature	260	°C
Storage Temperature	-65 ~ 150	°C
Operating Junction Temperature	150	°C
ESD Capability, Human Body Model	7000	V
ESD Capability, Machine Model	400	V

Operating Range

Parameter	Value	Unit
Thermal Resistance, R _{θJA}	250	°C/W
Input Voltage	2.1 ~ 5.5	V
Operating Temperature Range	-40~85	°C

Electronics Characteristics (V_{IN} = V_{OUT} +1V, C_{IN}=C_{OUT}=1uF, T_A=25°C, unless otherwise noted)

Parameter	Symbol	Condition	Min.	Typ.	Max.	Unit
Output Voltage	V _{OUT}	V _{out} <2V, I _{OUT} =1mA	-3%		+3%	
		V _{out} ≥2V, I _{OUT} =1mA	-2%		+2%	
Output Current	I _{OUT}	V _{OUT} =1.2V	150			mA
		V _{OUT} =2.0V	200			
		V _{OUT} =3.3V	300			
Output short current limiter	I _{LIM}	V _{OUT} =GND		80		mA
Dropout Voltage	V _{DROP}	I _{OUT} =100mA, V _{OUT} =3.3V		75		mV
		I _{OUT} =300mA, V _{OUT} =3.3V		230		
Line Regulation	ΔV _{LINE}	V _{IN} =V _{OUT} +1V~5.5V, I _{OUT} =40mA		0.1		%/V
Load Regulation	ΔV _{LOAD}	I _{OUT} = 1~ 300mA		20		mV
Quiescent Current	I _Q	V _{IN} = V _{OUT} +1V, I _{OUT} =0A		1.5	2.5	uA
Output Voltage Temperature Coefficient	TC	-40°C≤T _a ≤125°C		100		ppm/°C
Power Supply Ripple Rejection	PSRR	V _{p-p} =1V, F=100Hz, I _{OUT} =10mA		65		dB
		V _{p-p} =1V, F=1KHz, I _{OUT} =10mA		45		dB
Output Noise Voltage	V _{NO}	BW=10Hz to 100kHz I _{OUT} =10mA		50		uV _{rms}
Shut Down Current	I _{SD}	V _{EN} =0V		0.01	1.0	uA
Soft-Start Time	T _{SS}	V _{OUT} =10%-90%		500		us
EN Logic High Voltage	V _{ENH}	V _{IN} =5.5V, I _{OUT} =1mA	1.2			V
EN Logic Low Voltage	V _{ENL}	V _{IN} =5.5V, V _{OUT} =0V			0.4	V
Output Discharge resistance	R _{DIS}	V _{IN} =4.0V, V _{EN} =0V		120		Ω

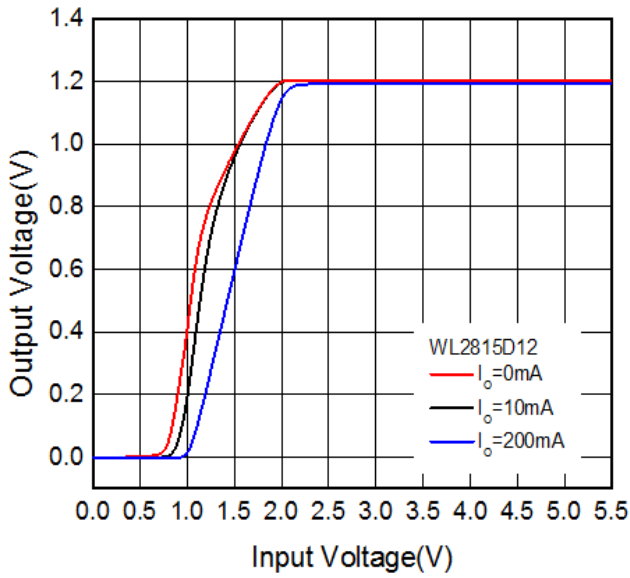
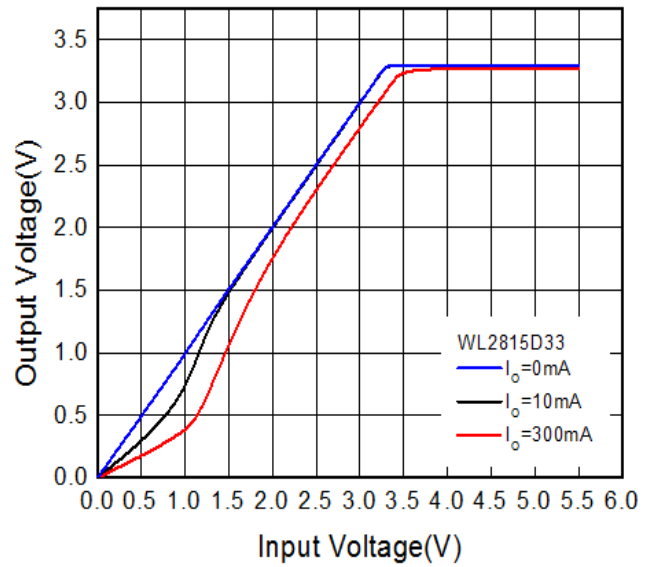
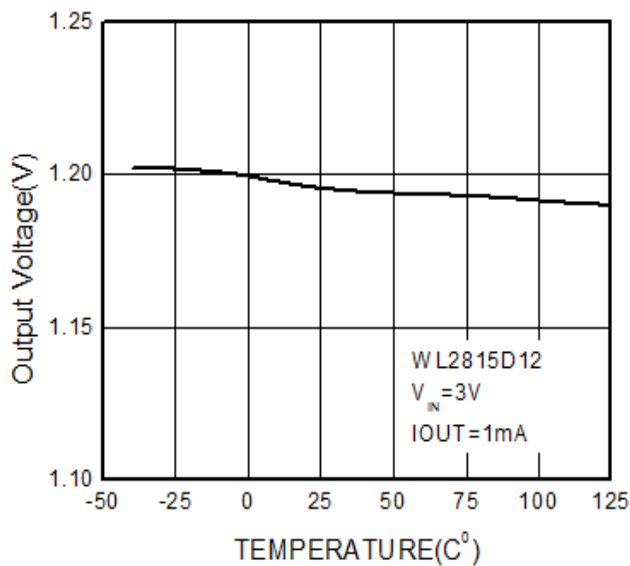
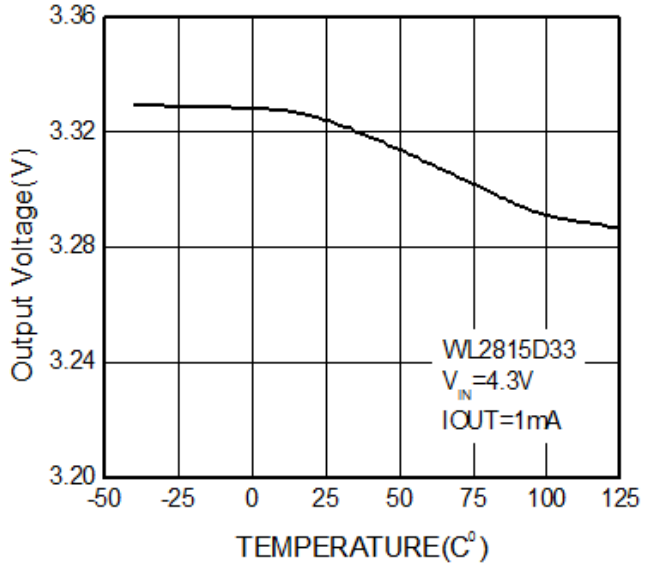
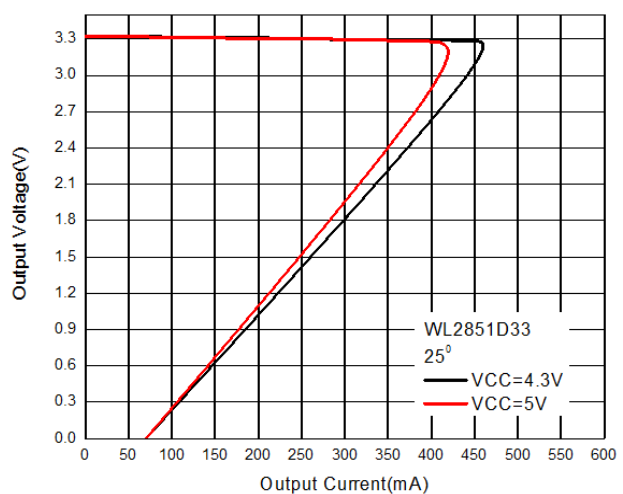
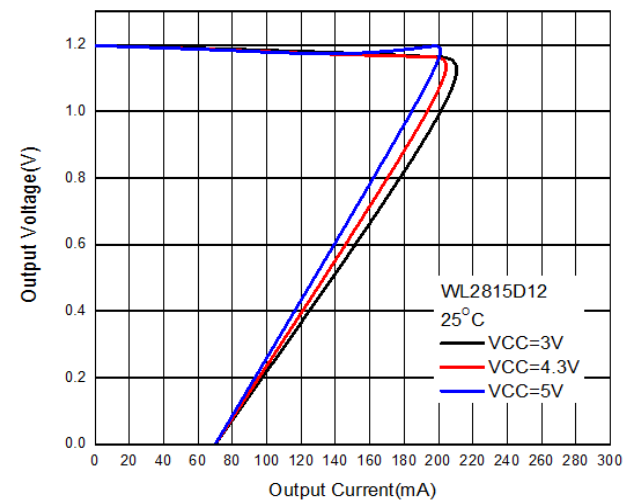
Typical Characteristics ($T_A=25^\circ\text{C}$, unless otherwise noted)

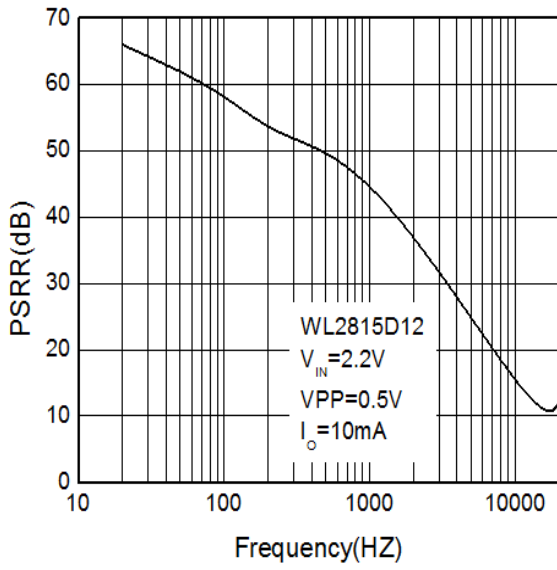
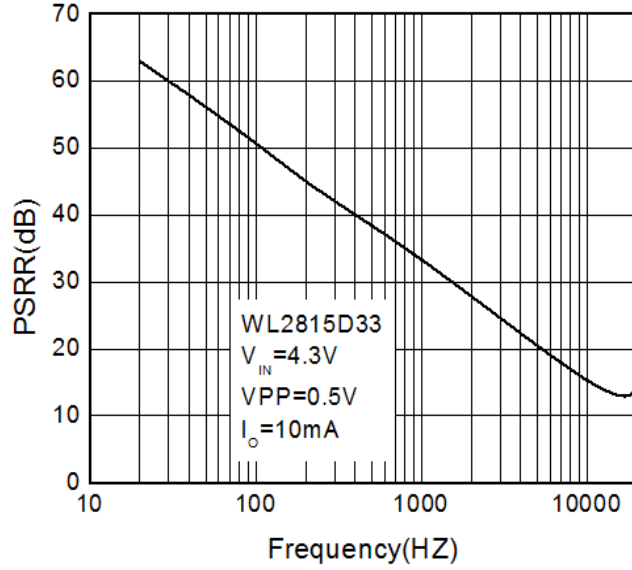
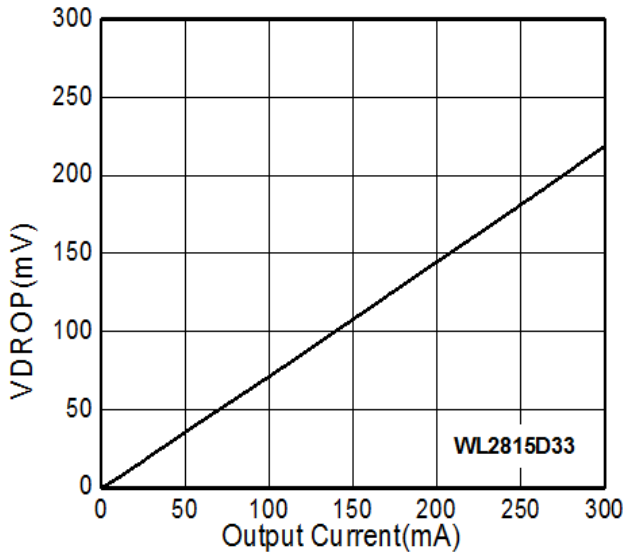
Output Voltage vs. Input Voltage

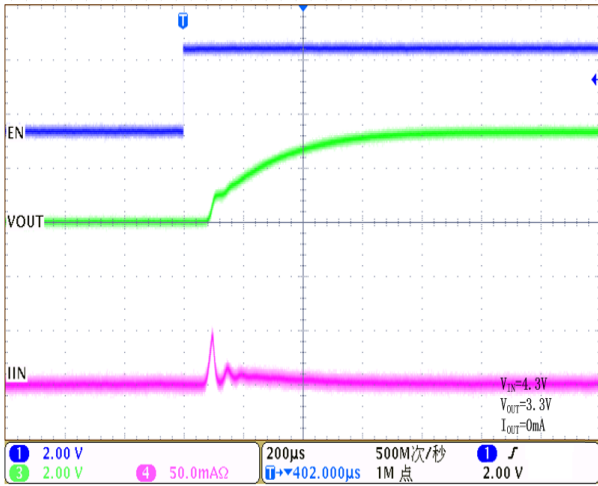
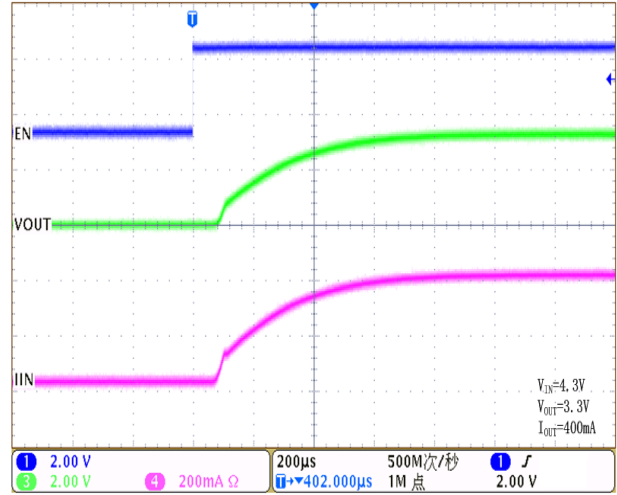
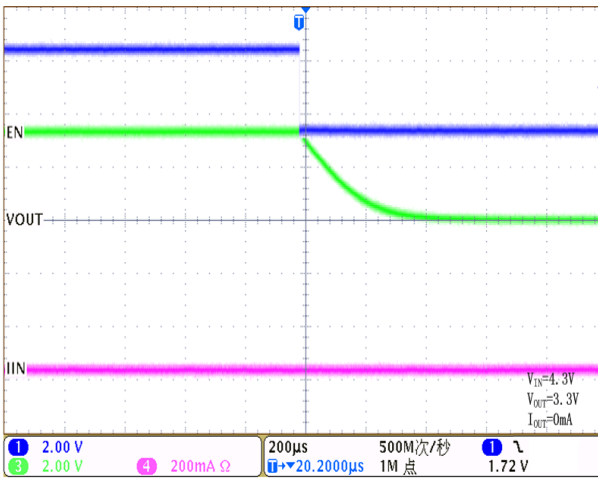
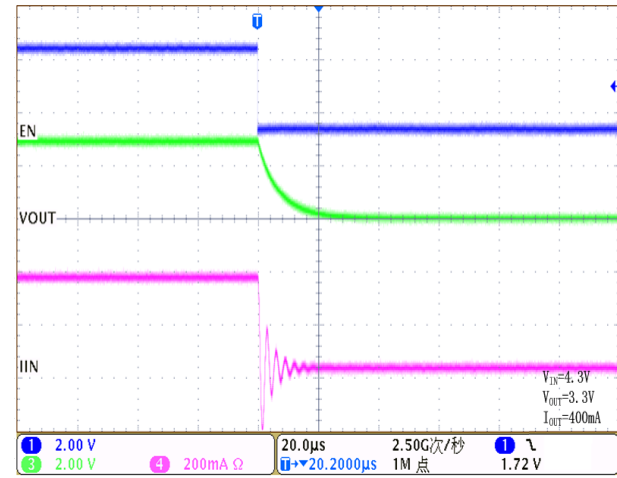
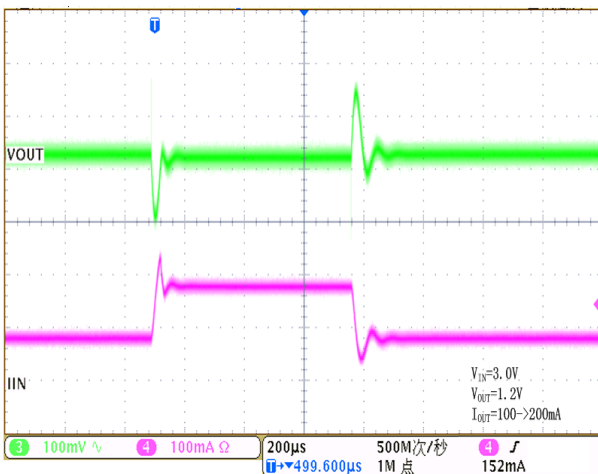
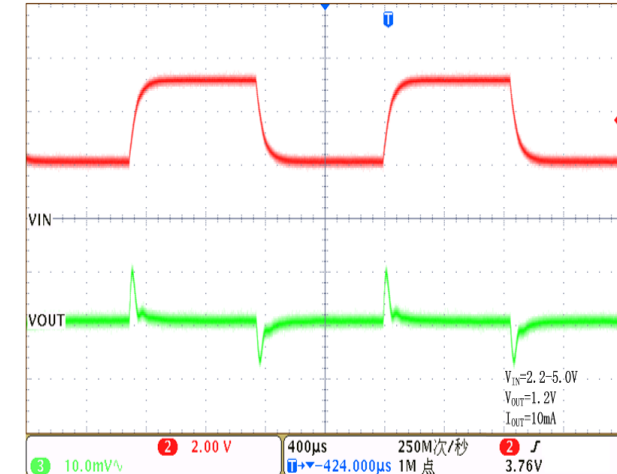
Output Voltage vs. Input Voltage

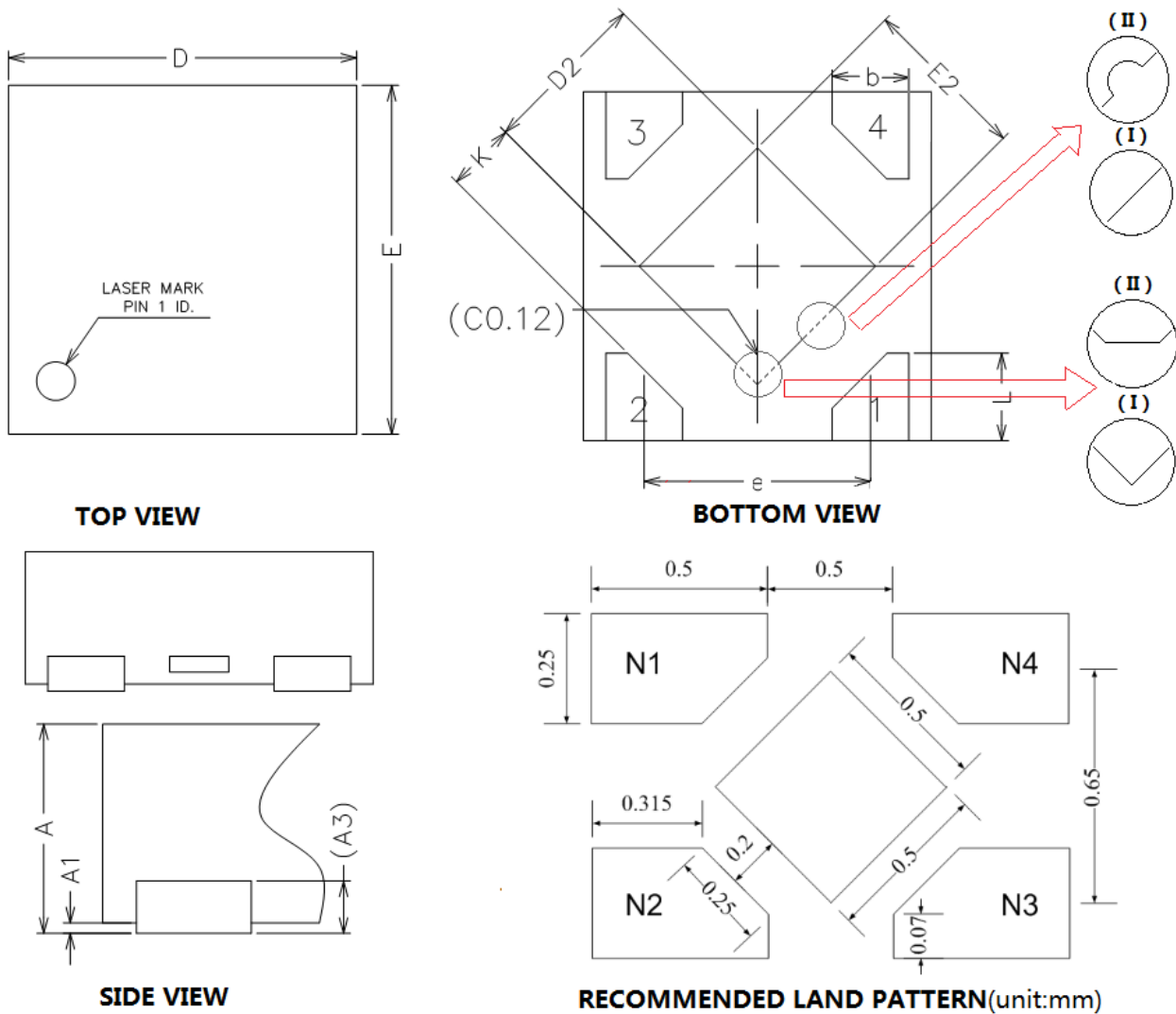
Output Voltage vs. Temperature

Output Voltage vs. Temperature

Output Voltage vs. Output Current

PSRR vs. Frequency
Output Voltage vs. Output Current

PSRR vs. Frequency

Dropout Voltage vs. Output Current

Turn On

Turn On

Turn Off

Turn Off

Load Step

Line Step

Packaging Information
DFN1x1-4L

Symbol	Dimensions In Millimeters		
	Min.	Typ.	Max.
A	0.34	0.37	0.40
A1	0.00	0.02	0.105
A3	0.10 REF		
b	0.17	0.22	0.27
D	0.95	1.00	1.05
E	0.95	1.00	1.05
D2	0.43	0.48	0.53
E2	0.43	0.48	0.53
L	0.20	0.25	0.30
e	0.60	0.65	0.70
K	0.15	-	-

Order Information

Ordering No.	Vout (V)	Package	Operating Temperature	Marking	Shipping
WL2815D11-4/TR	1.1	DFN-1X1-4L	-40~+85°C	AD YW	10,000 Tape & Reel
WL2815D12-4/TR	1.2	DFN-1X1-4L	-40~+85°C	AE YW	10,000 Tape & Reel
WL2815D15-4/TR	1.5	DFN-1X1-4L	-40~+85°C	AG YW	10,000 Tape & Reel
WL2815D18-4/TR	1.8	DFN-1X1-4L	-40~+85°C	AH YW	10,000 Tape & Reel
WL2815D20-4/TR	2.0	DFN-1X1-4L	-40~+85°C	AI YW	10,000 Tape & Reel
WL2815D25-4/TR	2.5	DFN-1X1-4L	-40~+85°C	AK YW	10,000 Tape & Reel
WL2815D28-4/TR	2.8	DFN-1X1-4L	-40~+85°C	AL YW	10,000 Tape & Reel
WL2815D30-4/TR	3.0	DFN-1X1-4L	-40~+85°C	AM YW	10,000 Tape & Reel
WL2815D33-4/TR	3.3	DFN-1X1-4L	-40~+85°C	AN YW	10,000 Tape & Reel

Marking:

A: Device Code

*** : Voltage Code**

Y : Year Code

W: Week Code

制 修 订 记 录					
文件版本	制修日期	变更内容			
Rev.1.5	2016/06/17	所有 VDD 改成 VIN, Tape & Reel 改成 10,000			
Rev.1.6	2017/03/2	添加 1.1V 电压输出版本			
批准		审核		编制	
日期		日期		日期	
各部门会签					
应用部	品质部封装组	市场部	生产管理部		