

Features

- Low Power Consumption: 2 μ A (Typ)
- Maximum Output Current: 350mA
- Small Dropout Voltage
350mV@100mA (Vout=3.3V)
- High Input Voltage: Up to55V
- High Accurate:
WL9200 (B) \pm 2% Output Voltage
WL9200 (A) \pm 1% Output Voltage
- RoHS Compliant and Lead (Pb) Free
- Good Transient Response
- Integrated Short-Circuit Protection
- Over-Temperature Protection
- Output Current Limit
- Stable with Ceramic Capacitor
- Support Fixed Output Voltage
1.8,2.5,2.8,3.0,3.3,3.6,4.0,4.2 and 5.0V
- Available Package
SOT23-3 \ SOT89-3

Application

- Portable, Battery Powered Equipment
- Battery-powered equipment
- Weighting Scales
- Smoke detector and sensor
- Audio/Video Equipmen
- Home Automation

Description

The WL9200 series is a high voltage, ultralow-power, low dropout voltage regulator. The device can deliver 350mA output current with a dropout voltage of 350mV and allows an input voltage as high as 55V. The typical quiescent current is only 2 μ A. The device is available in fixed output voltages of 1.8,2.5,2.8,3.0,3.3,3.6,4.0,4.2,4.4 and 5.0V.The device features integrated short-circuit and thermal shutdown protection.Although designed primarily as fixed voltage regulators, the device can be used with external components to obtain variable voltages.

Application Circuits

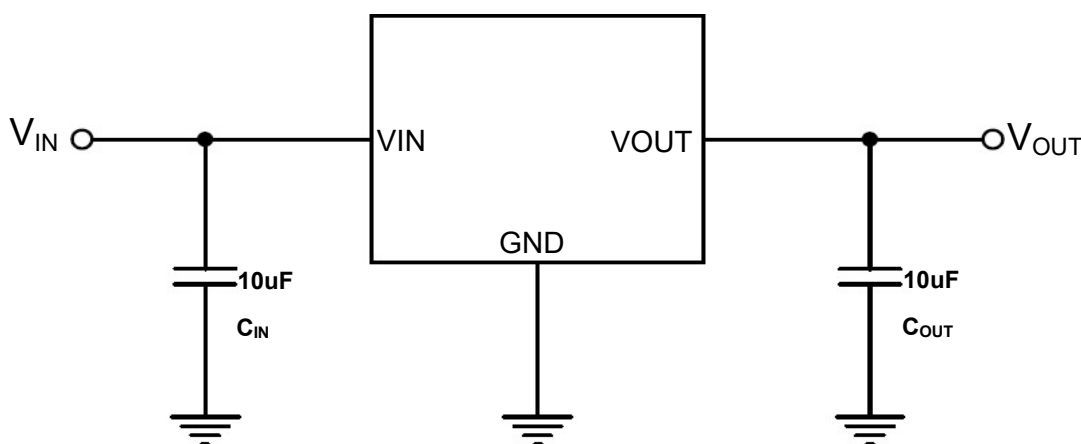

Pin Configuration

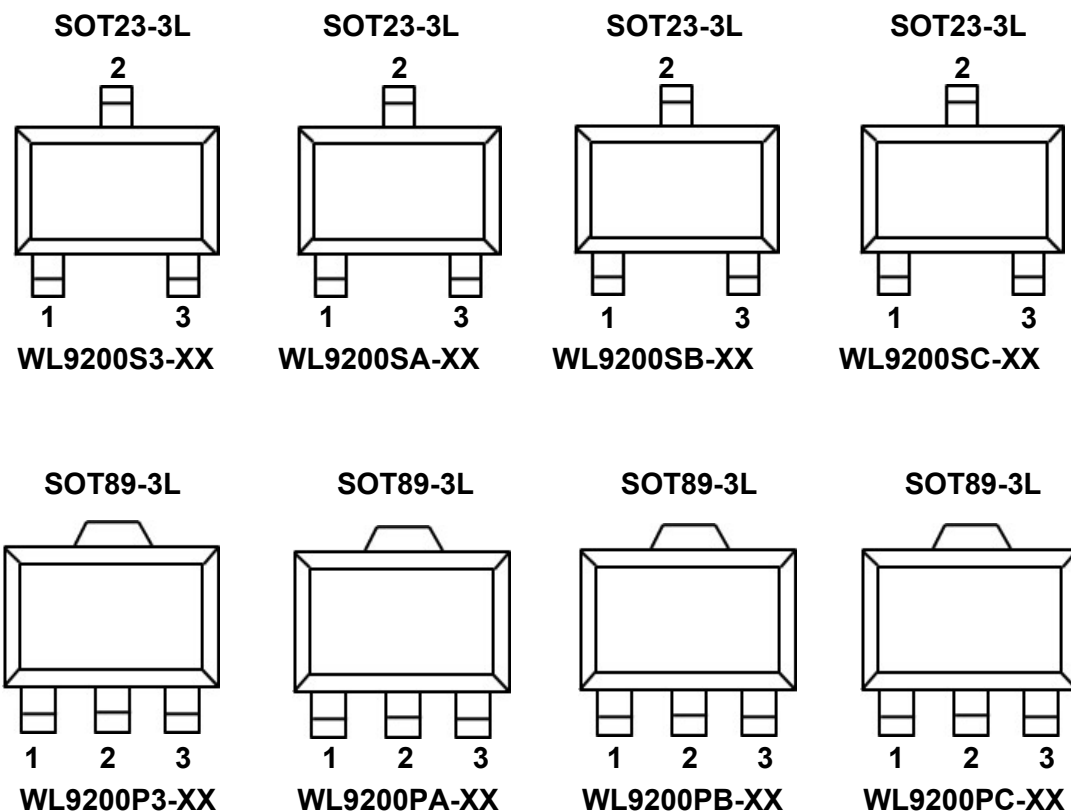

Pin Description

| SOT23-3L Pin No. | | | | Pin Name | Pin Function |
|------------------|--------------|--------------|--------------|----------|----------------------|
| WL9200S3-XX | WL9200SA-XX* | WL9200SB-XX* | WL9200SC-XX* | | |
| 1 | 3 | 2 | 2 | GND | Ground. |
| 2 | 2 | 1 | 3 | VIN | Supply voltage input |
| 3 | 1 | 3 | 1 | VOUT | Voltage Output |
| SOT89-3L Pin No. | | | | Pin Name | Pin Function |
| WL9200P3-XX | WL9200PA-XX* | WL9200PB-XX* | WL9200PC-XX* | | |
| 1 | 3 | 2 | 2 | GND | Ground. |
| 2 | 2 | 1 | 3 | VIN | Supply voltage input |
| 3 | 1 | 3 | 1 | VOUT | Voltage Output |

NOTE: (*) It needs to be customized

Order Information

WL9200①②-③④⑤

| Designator | Symbol | Description |
|------------|---------|---|
| ①② | S3/P3 | SOT23-3L / SOT89-3L |
| ③④ | Integer | Output Voltage 1.8,2.5,2.8,3.0,3.3,3.6,4.0,4.2 and 5.0V |
| ⑤ | A | Accurate ±1% |
| | B | Accurate ±2% |

| Model | Marking | Description | Package | T/R Qty |
|--------------|----------|---|----------|-----------|
| WL9200S3-XX* | AHXXA(B) | WL9200 55V;2μA IQ, 350mA Low-Dropout LDO | SOT23-3L | 3,000 PCS |
| WL9200P3-XX* | AHXXA(B) | | SOT89-3L | 1,000 PCS |

Note: (*) XX Represents the Output Voltage

Marking Information ①②③④⑤

①②Represents the product name

| Mark ①② | Product Series |
|---------|----------------|
| AH | WL9200 S3 / P3 |

③④Represents the Output Voltage

| Mark | Output Voltage (V) | | | Mark | Output Voltage (V) | | |
|------|--------------------|-----|---|------|--------------------|-----|---|
| 18 | — | 1.8 | — | 36 | — | 3.6 | — |
| 25 | — | 2.5 | — | 40 | — | 4.0 | — |
| 28 | — | 2.8 | — | 42 | — | 4.2 | — |
| 30 | — | 3.0 | — | 50 | — | 5.0 | — |
| 33 | — | 3.3 | — | — | — | — | — |

⑤Represents the Output Voltage Accurate

| Mark⑤ | | Product Series |
|--------------------|--------------------|-----------------|
| ±1% Output Voltage | ±2% Output Voltage | WL9200 (A or B) |
| A | B | |

Absolute Maximum Ratings ^{(1) (2)}

| Parameter | | Symbol | Maximum Rating | Unit |
|------------------------------|---------|---------------------------------|--|------|
| Input Voltage | | V _{IN} | V _{SS} -0.3~V _{SS} +55.0 | V |
| | | V _{OUT} | V _{SS} -0.3~V _{SS} +6.0 | V |
| Output Current | | I _{OUT} | 350 | mA |
| Power Dissipation | SOT23-3 | P _d | 400 | mW |
| | SOT89-3 | | 500 | |
| Thermal Resistance | SOT23-3 | R _{θJA} ⁽³⁾ | 250 | °C/W |
| | SOT89-3 | | 200 | °C/W |
| Operating Temperature | | T _{opr} | -40~85 | °C |
| Storage Temperature | | T _{stg} | -40~125 | °C |
| Soldering Temperature & Time | | T _{solder} | 260°C, 10s | |

Note (1): Exceeding these ratings may damage the device.

Note (2): The device is not guaranteed to function outside of its operating conditions

Note (3): The package thermal impedance is calculated in accordance to JESD 51-7.

ESD Ratings

| Item | Description | Value | Unit |
|------------------------|--|-------|------|
| V _(ESD-HBM) | Human Body Model (HBM) ANSI/ESDA/JEDEC JS-001-2014 Classification, Class: 2 | ±4000 | V |
| V _(ESD-CDM) | Charged Device Mode (CDM) ANSI/ESDA/JEDEC JS-002-2014 Classification, Class: C0b | ±200 | V |
| I _{LATCH-UP} | JEDEC STANDARD NO.78E APRIL 2016 Temperature Classification, Class: I | ±150 | mA |

ESD testing is performed according to the respective JEDEC22 JEDEC standard. The human body model is a 100 pF capacitor discharged through a 1.5kΩ resistor into each pin. The machine model is a 200pF capacitor discharged directly into each pin.

Recommended Operating Conditions

| Parameter | MIN. | MAX. | Units |
|--|------|------|-------|
| Supply voltage at V _{IN} | 3.0 | 24 | V |
| Operating junction temperature range, T _j | -40 | 125 | °C |
| Operating free air temperature range, T _A | -40 | 85 | °C |

Note : All limits specified at room temperature (T_A = 25°C) unless otherwise specified. All room temperature limits are 100% production tested. All limits at temperature extremes are ensured through correlation using standard Statistical Quality Control (SQC) methods. All limits are used to calculate Average Outgoing Quality Level (AOQL).

Electrical Characteristics

(Test Conditions: $V_{IN} = V_{set} + 1V$, $V_{OUT} = V_{set}$, $C_{IN} = 10\mu F$, $C_{OUT} = 10\mu F$, $T_A = 25^\circ C$, unless otherwise specified.)

| Parameter | Symbol | Conditions | Min | Typ | Max | Units |
|--|--|--|------------------|-----------|------------------|-----------------|
| Input Voltage | V_{IN} | | 3.0 | | 55 | V |
| Supply Current | I_Q | $V_{IN} = 12V$ $I_{LOAD} = 0mA$ | — | 2.0 | 3.0 | μA |
| Output Voltage WL9200 (A) | V_{OUT1} | $V_{IN} = 12V$ $I_{OUT} = 10mA$ | $V_{set} * 0.99$ | V_{set} | $V_{set} * 1.01$ | V |
| Output Voltage WL9200 (B) | V_{OUT2} | $V_{IN} = 12V$ $I_{OUT} = 10mA$ | $V_{set} * 0.98$ | V_{set} | $V_{set} * 1.02$ | V |
| Maximum Output Current | $I_{OUT(Max)}$ | — | 300 | 350 | — | mA |
| Dropout Voltage | $V_{DROP}^{(1)}$ $V_{OUT} = 3.3V$ | $V_{IN} = V_{set} - 0.1V$ $I_{OUT} = 10mA$ | — | 35 | — | mV |
| | | $V_{IN} = V_{set} - 0.1V$ $I_{OUT} = 100mA$ | — | 350 | — | |
| Line Regulation | $\frac{\Delta V_{OUT}}{\Delta V_{IN} \cdot V_{OUT}}$ | $I_{OUT} = 1mA$ $(V_{set} + 0.5V) \leq V_{IN} \leq 55V$ | — | 0.01 | — | %/V |
| Load Regulation | ΔV_{OUT} | $V_{IN} = 12V$ $1mA \leq I_{OUT} \leq 100mA$ | — | 0.02 | — | %/ mA |
| Short Current | I_{SHORT} | $R_L = 1\Omega$ | — | 100 | — | mA |
| Output Noise Voltage | e_{NO} | $C_{OUT} = 1\mu F$ $BW = 300Hz \sim 50kHz$ | — | 50 | — | μV_{RMS} |
| Output Voltage Temperature Coefficient | $\frac{\Delta V_{OUT}}{\Delta T \cdot V_{OUT}}$ | $I_{OUT} = 10mA$ | — | 100 | — | ppm/ $^\circ C$ |

Note: (1) Dropout Voltage is the voltage difference between the input and the output at which the output voltage drops 2% below its nominal value.

Typical Performance Characteristics:

Test Condition: TA=25°C, Iout=1mA, COUT=10uF, unless otherwise noted

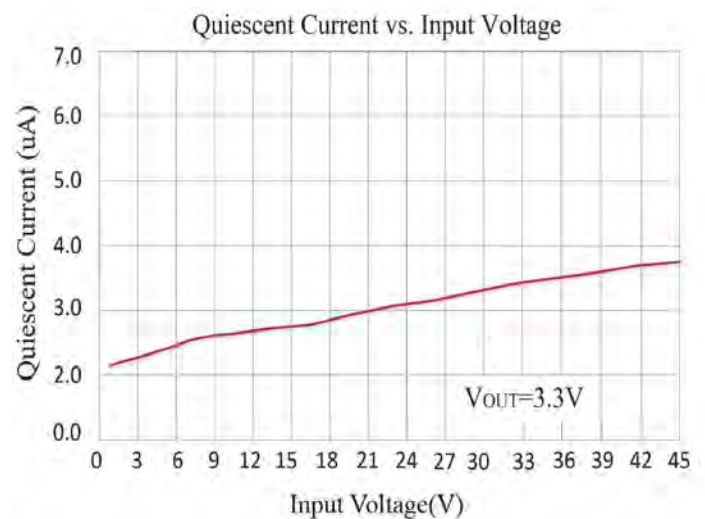
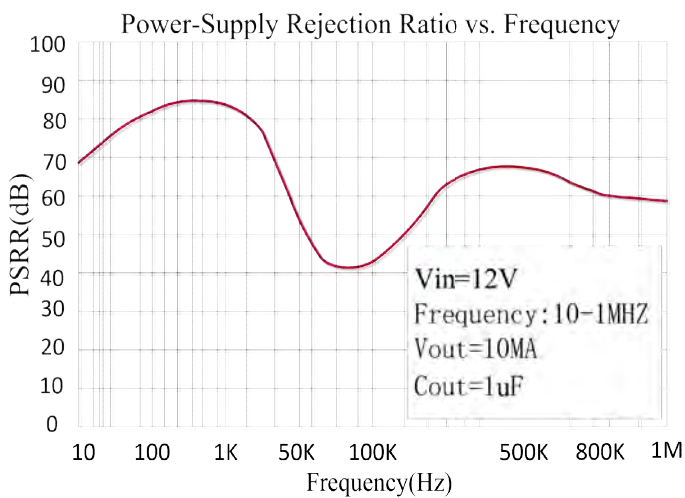
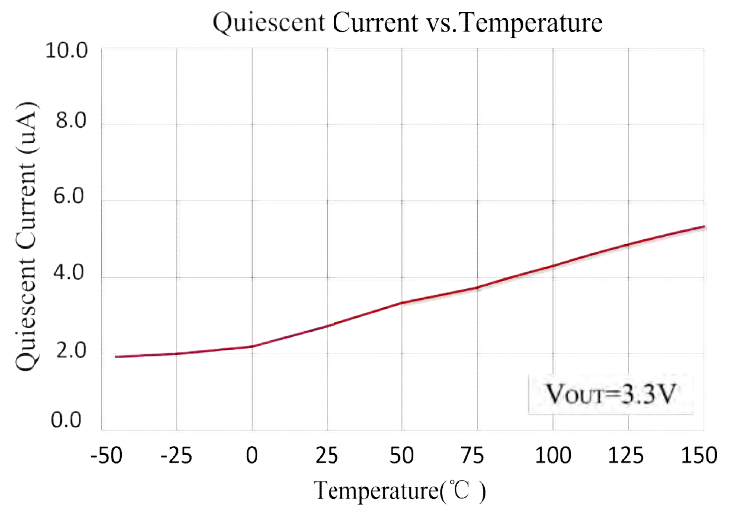
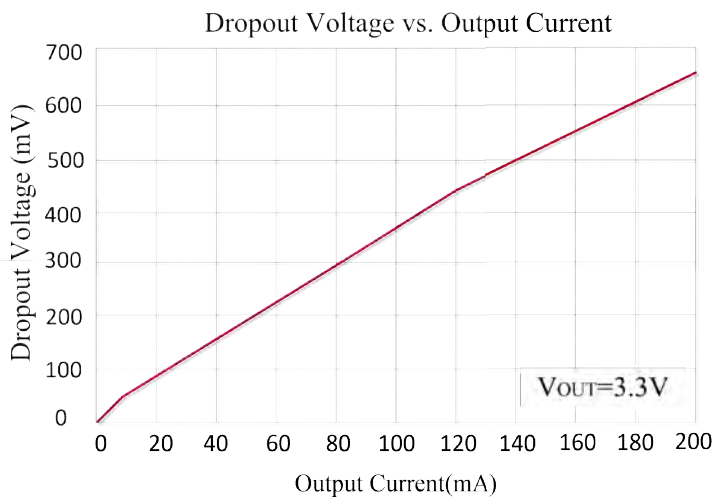
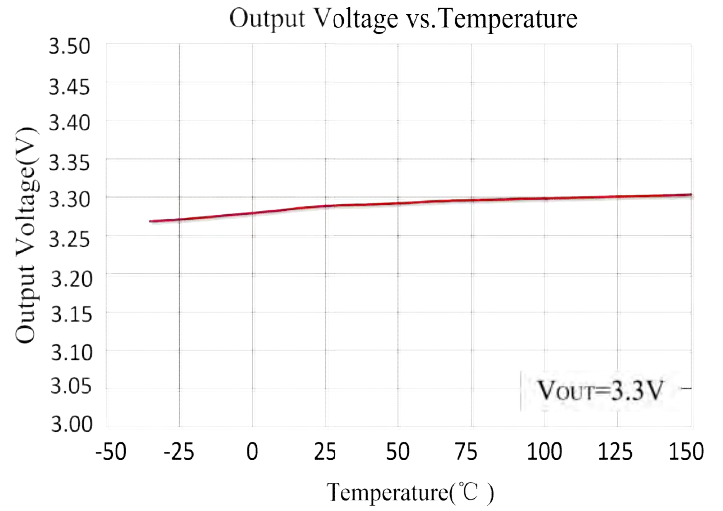
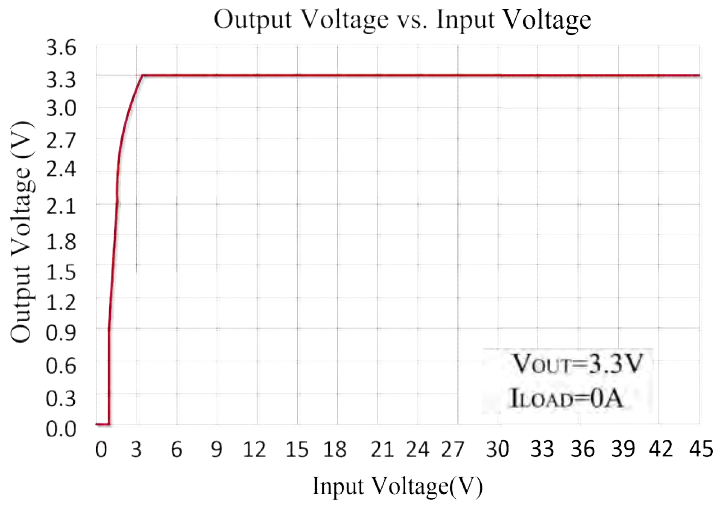

Line Transient Response ($V_{IN}=5$ to 24V $V_{OUT}=3.3V$)

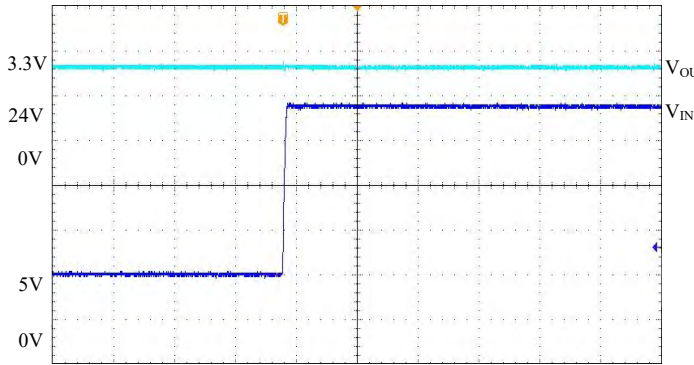

Line Transient Response ($V_{IN}=24$ to 5V $V_{OUT}=3.3V$)

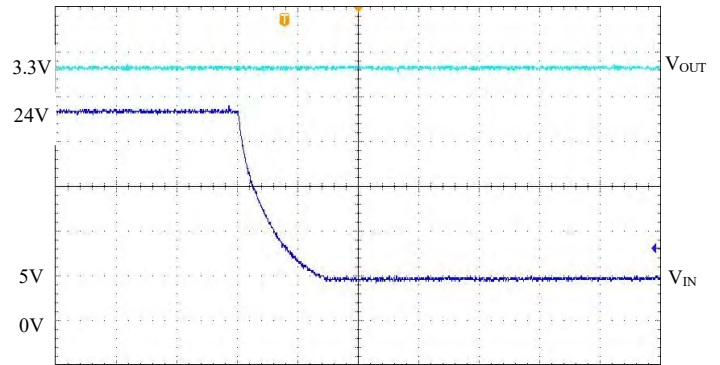

Load Transient Response ($V_{IN}=5V$ $V_{OUT}=0V$ $I_{OUT}=140mA$)

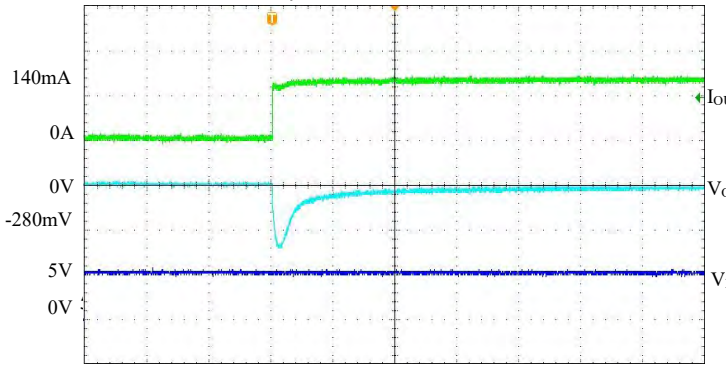

Load Transient Response ($V_{IN}=5V$ $V_{OUT}=0V$ $I_{OUT}=140-0mA$)

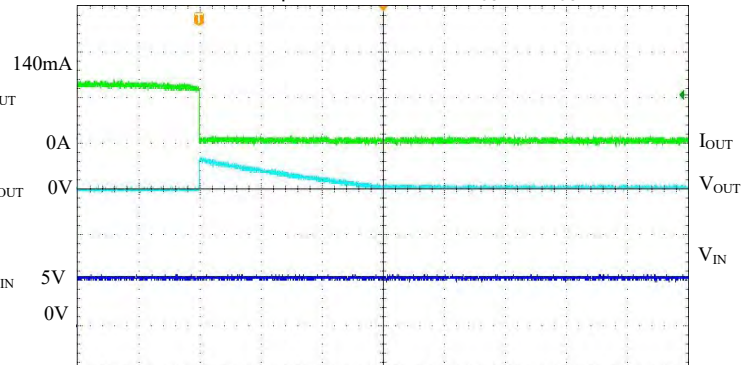

Start Up ($V_{IN}=24V$ $V_{OUT}=3.3V$)

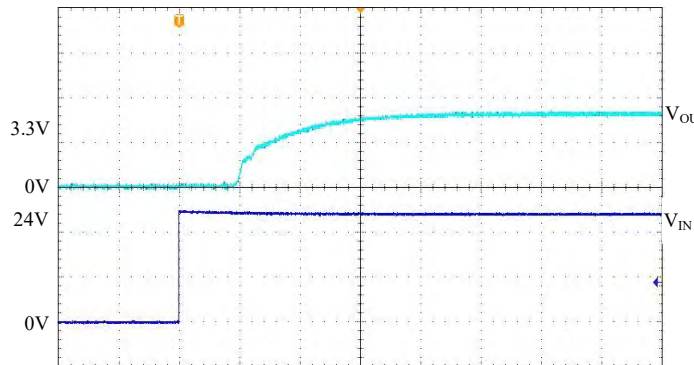

Start Up ($V_{IN}=24V$ $V_{OUT}=3.3V$ $I_{OUT}=150mA$)

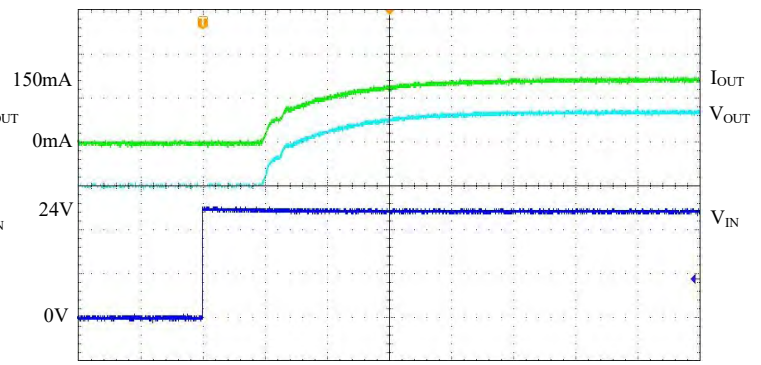

Short Circuit Protection ($V_{IN}=5V$ $V_{OUT}=3.3V$ to short)

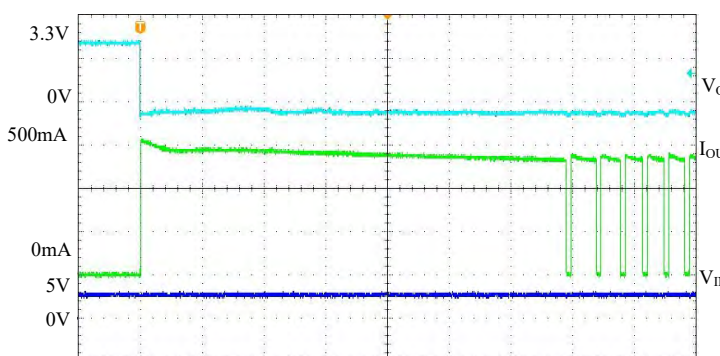

Short Circuit Protection ($V_{IN}=6V$ $V_{OUT}=\text{short to } 3.3V$)

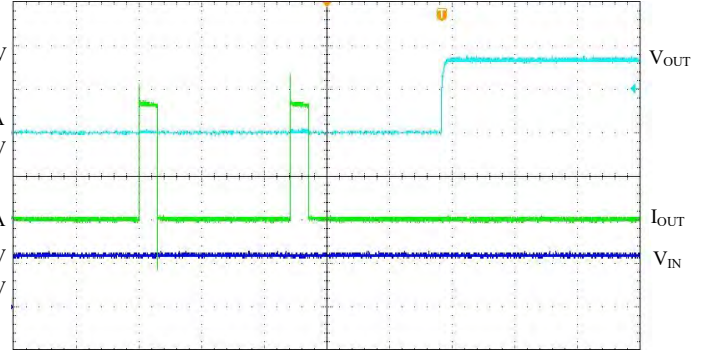

Function Block Diagram

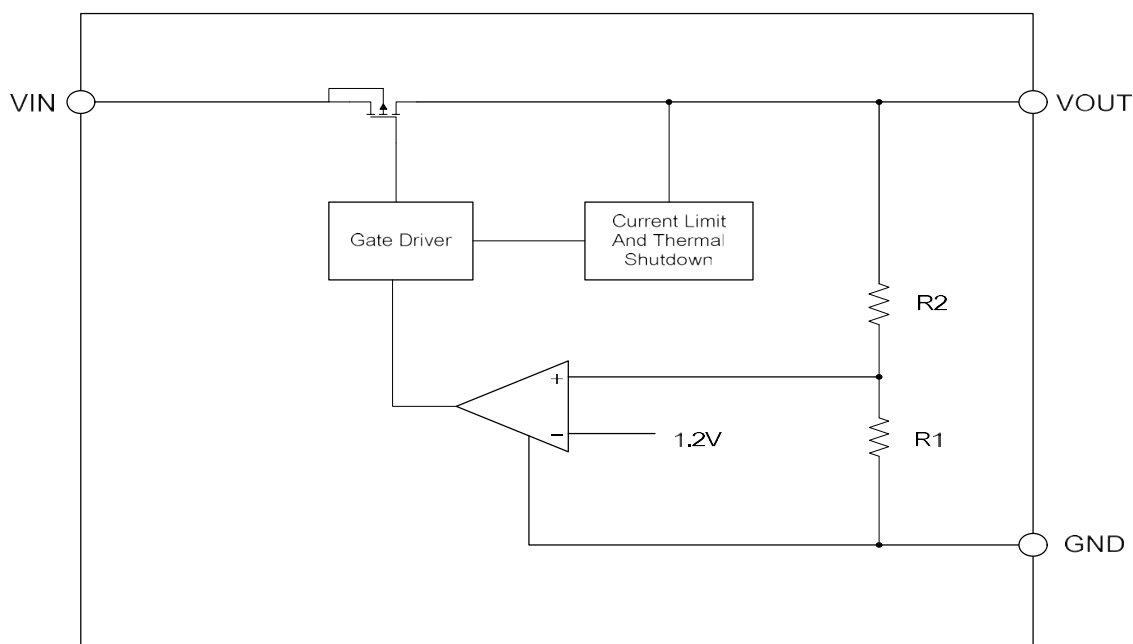

Application Guideline

Input Capacitor

A 10μF ceramic capacitor is recommended to connect between V_{DD} and GND pins to decouple input power supply glitch and noise. The amount of the capacitance may be increased without limit. This input capacitor must be located as close as possible to the device to assure input stability and less noise. For PCB layout, a wide copper trace is required for both VIN and GND.

Output Capacitor

An output capacitor is required for the stability of the LDO. The recommended output capacitance is 10μF, ceramic capacitor is recommended, and temperature characteristics are X7R or X5R. Higher capacitance values help to improve load/line transient response. The output capacitance may be increased to keep low undershoot/overshoot. Place output capacitor as close as possible to VOUT and GND pins.

Dropout Voltage

The dropout voltage refers to the voltage difference between the VIN and VOUT pins while operating at specific output current. The dropout voltage V_{DROP} also can be expressed as the voltage drop on the pass-FET at specific output current (I_{RATED}) while the pass-FET is fully operating at ohmic region and the pass-FET can be characterized as a resistance $R_{DS(ON)}$. Thus the dropout voltage can be defined as ($V_{DROP} = V_{IN} - V_{OUT} = R_{DS(ON)} \times I_{RATED}$). For normal operation, the

suggested LDO operating range is ($V_{IN} > V_{OUT} + V_{DROP}$) for good transient response and PSRR ability. Vice versa, while operating at the ohmic region will degrade the performance severely.

Thermal Application

For continuous operation, do not exceed the absolute maximum junction temperature. The maximum power dissipation depends on the thermal resistance of the IC package, PCB layout, rate of surrounding airflow, and difference between junction and ambient temperature. The maximum power dissipation can be calculated as below: $T_A = 25^\circ\text{C}$, PCB,

The max PD = $(125^\circ\text{C} - 25^\circ\text{C}) / (\text{Thermal Resistance } ^\circ\text{C/W})$

Power dissipation (PD) is equal to the product of the output current and the voltage drop across the output pass element, as shown in the equation below:

$$PD = (V_{IN} - V_{OUT}) \times I_{OUT}$$

Layout Consideration

By placing input and output capacitors on the same side of the PCB as the LDO, and placing them as close as is practical to the package can achieve the best performance. The ground connections for input and output capacitors must be back to the WL9200 ground pin using as wide and as short of a copper trace as is practical. Connections using long trace lengths, narrow trace widths, and/or connections through via must be avoided. These add parasitic inductances and resistance that results in worse performance especially during transient conditions.

Packaging Information

SOT23-3L

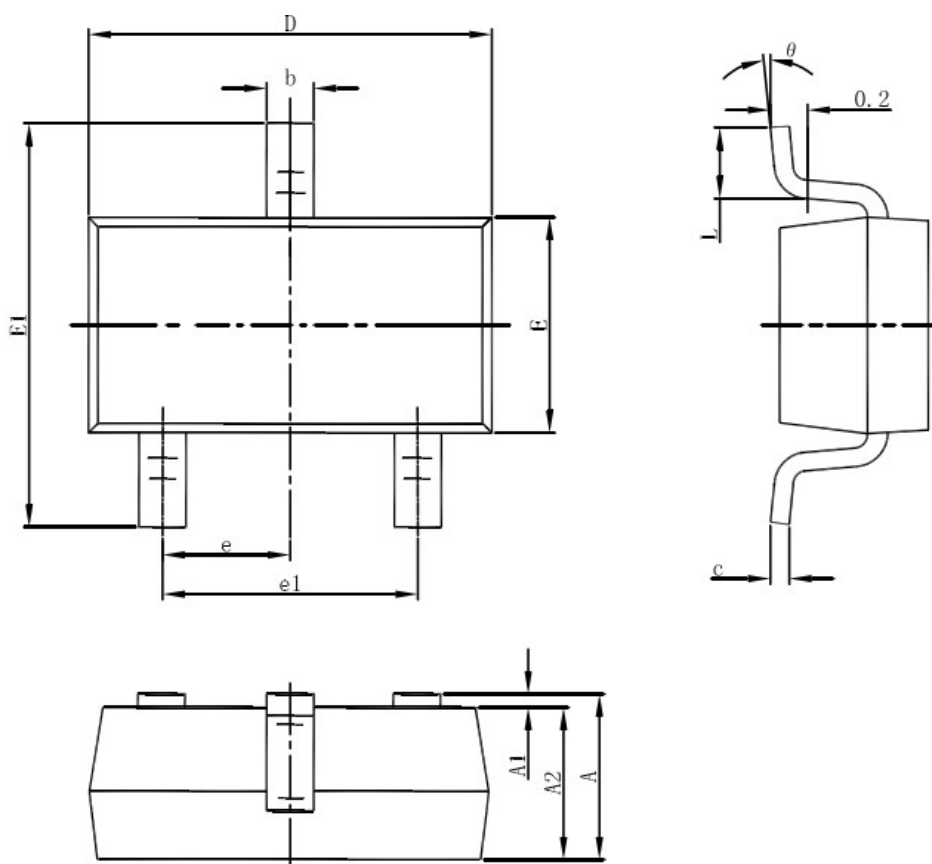

| Symbol | Dimensions In Millimeters | | Dimensions In Inches | |
|----------|---------------------------|-------|----------------------|-------|
| | Min | Max | Min | Max |
| A | 1.050 | 1.250 | 0.041 | 0.049 |
| A1 | 0.000 | 0.100 | 0.000 | 0.004 |
| A2 | 1.050 | 1.150 | 0.041 | 0.045 |
| b | 0.300 | 0.500 | 0.012 | 0.020 |
| c | 0.100 | 0.200 | 0.004 | 0.008 |
| D | 2.820 | 3.020 | 0.111 | 0.119 |
| E | 1.500 | 1.700 | 0.059 | 0.067 |
| E1 | 2.650 | 2.950 | 0.104 | 0.116 |
| e | 0.950(BSC) | | 0.037(BSC) | |
| e1 | 1.800 | 2.000 | 0.071 | 0.079 |
| L | 0.300 | 0.600 | 0.012 | 0.024 |
| θ | 0° | 8° | 0° | 8° |

Packaging Information

SOT89-3L

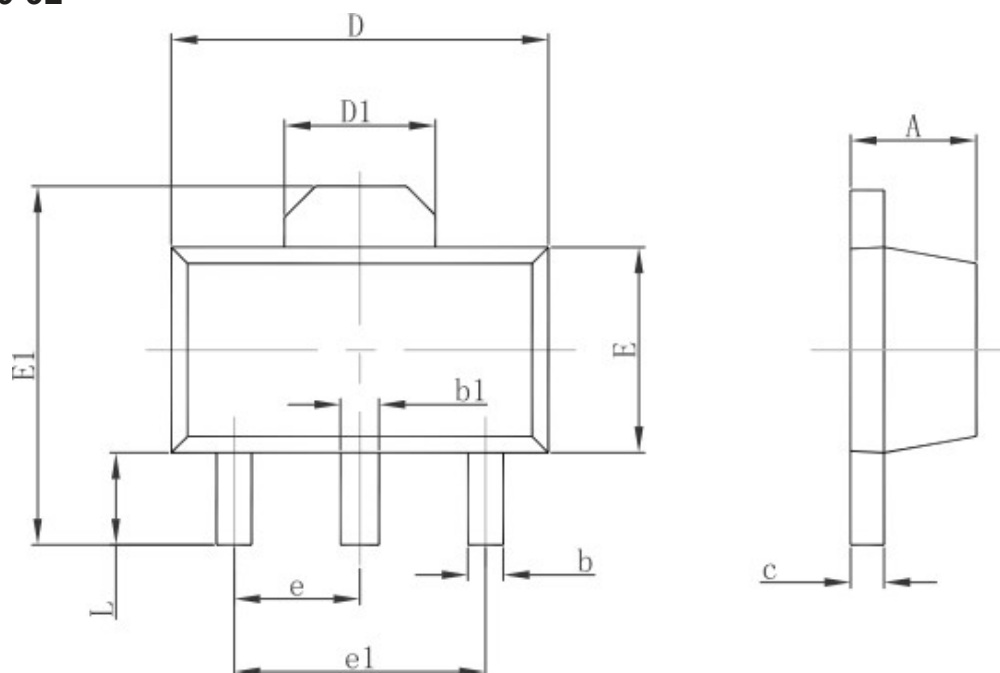

| Symbol | Dimensions In Millimeters | | Dimensions In Inches | |
|--------|---------------------------|-------|----------------------|-------|
| | Min. | Max. | Min. | Max. |
| A | 1.400 | 1.600 | 0.055 | 0.063 |
| b | 0.320 | 0.520 | 0.013 | 0.020 |
| b1 | 0.400 | 0.580 | 0.016 | 0.023 |
| c | 0.350 | 0.440 | 0.014 | 0.017 |
| D | 4.400 | 4.600 | 0.173 | 0.181 |
| D1 | 1.550 REF. | | 0.061 REF. | |
| E | 2.300 | 2.600 | 0.091 | 0.102 |
| E1 | 3.940 | 4.250 | 0.155 | 0.167 |
| e | 1.500 TYP. | | 0.060 TYP. | |
| e1 | 3.000 TYP. | | 0.118 TYP. | |
| L | 0.900 | 1.200 | 0.035 | 0.047 |

WPMtek reserves the right to make changes to the product specification and data in this document without notice. WPMtek makes no warranty, representation or guarantee regarding the suitability of its products for any particular purpose, nor does WPMtek assume any liability arising from the application or use of any products or circuits, and specifically disclaims any and all liability, including without limitation special, consequential or incidental damages. Any enquiry, please write to sales@wpmtek.com for further information.