



WM2639 12-Bit Parallel Input Voltage Output DAC with Internal Reference

Production Data, July 1999, Rev 1.0

FEATURES

- 12-bit voltage output DAC
- Single supply 2.7V to 5.5V operation
- DNL ± 0.3 LSBs, INL ± 1.2 LSBs
- Internal programmable voltage reference
- Settling time $1\mu\text{s}$ typical
- 12-bit microprocessor compatible interface
- Power down mode 10nA

APPLICATIONS

- Battery powered test instruments
- Digital offset and gain adjustment
- Battery operated/remote industrial controls
- Machine and motion control devices
- Wireless telephone and communication systems
- Speech synthesis
- Arbitrary waveform generation
- Mass storage devices

ORDERING INFORMATION

DEVICE	TEMP. RANGE	PACKAGE
WM2639CDT	0° to 70°C	20-pin TSSOP
WM2639IDT	-40° to 85°C	20-pin TSSOP

BLOCK DIAGRAM

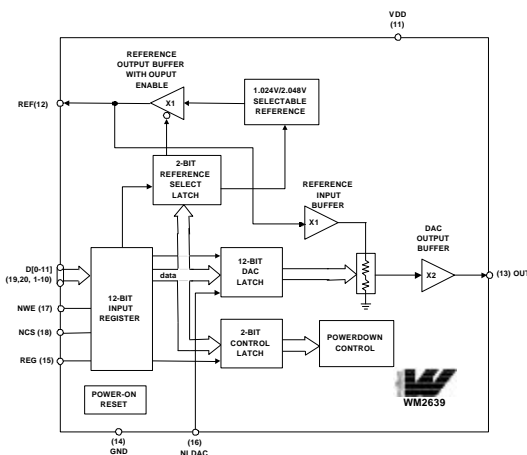

DESCRIPTION

The WM2639 is a 12-bit voltage output, resistor string, digital-to-analogue converter. A hardware controlled power down mode is provided that reduces current consumption to 10nA. The device has been designed to interface efficiently to industry standard microprocessors and DSPs.

The WM2639 features an internal programmable voltage reference simplifying overall system design. The reference voltage can also be supplied externally.

Excellent performance is delivered with a typical DNL of 0.3 LSBs and typical INL of 1.2 LSBs. The output stage is buffered by a x2 gain near rail-to-rail amplifier, which features a Class A output stage (slow mode, Class AB). The 12 data bits are double buffered enabling the output to be asynchronously updated under hardware control. The settling time of the DAC is software programmable to allow the designer to optimise speed versus power dissipation.

The device is available in a 20-pin TSSOP package. Commercial temperature (0° to 70°C) and Industrial temperature (-40° to 85°C) variants are supported.

TYPICAL PERFORMANCE

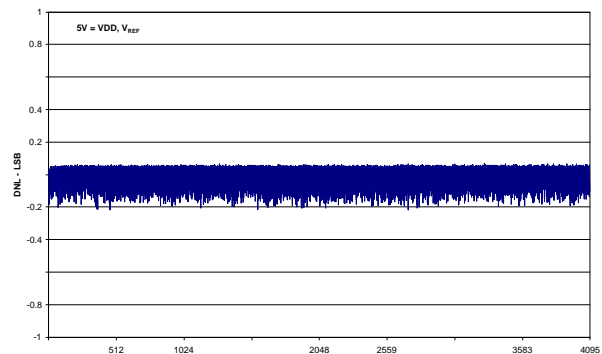

WOLFSON MICROELECTRONICS LTD
Lutton Court, Bernard Terrace, Edinburgh, EH8 9NX, UK
Tel: +44 (0) 131 667 9386
Fax: +44 (0) 131 667 5176
Email: sales@wolfson.co.uk
http://www.wolfson.co.uk

Production Data contain final specifications current on publication date. Supply of products conforms to Wolfson Microelectronics' Terms and conditions..

Master 15/07/99 15:02

©1999 Wolfson Microelectronics Ltd.

PIN CONFIGURATION

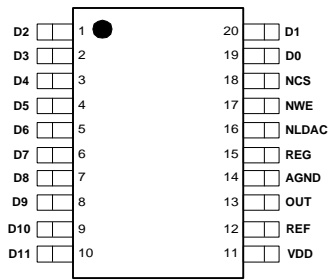

PIN DESCRIPTION

PIN NO	NAME	TYPE	DESCRIPTION
1	D2	Digital input	Data input.
2	D3	Digital input	Data input.
3	D4	Digital input	Data input.
4	D5	Digital input	Data input.
5	D6	Digital input	Data input.
6	D7	Digital input	Data input.
7	D8	Digital input	Data input.
8	D9	Digital input	Data input.
9	D10	Digital input	Data input.
10	D11	Digital input	Data input.(MSB)
11	VDD	Supply	Positive power supply.
12	REF	Analogue I/O	Analogue reference voltage input/output.
13	OUT	Analogue output	DAC analogue voltage output.
14	AGND	Supply	Analogue Ground.
15	REG	Digital input	Register select. Digital input used to access control register.
16	NLDAC	Digital input	Load DAC. Digital input active low. NLDAC must be taken low to update the DAC latch from the holding latches.
17	NWE	Digital input	Write enable. Digital input active low.
18	NCS	Digital input	Chip select. Digital input active low.
19	D0	Digital input	Data input. (LSB)
20	D1	Digital input	Data input.

ABSOLUTE MAXIMUM RATINGS

Absolute Maximum Ratings are stress ratings only. Permanent damage to the device may be caused by continuously operating at or beyond these limits. Device functional operating limits and guaranteed performance specifications are given under Electrical Characteristics at the test conditions specified



ESD Sensitive Device. This device is manufactured on a CMOS process. It is therefore generically susceptible to damage from excessive static voltages. Proper ESD precautions must be taken during handling and storage of this device.

CONDITION		MIN	MAX
Digital supply voltages, VDD to GND			7V
Reference input voltage		-0.3V	VDD + 0.3V
Digital input voltage range to GND		-0.3V	VDD + 0.3V
Operating temperature range, T _A	WM2639CDT	0°C	70°C
	WM2639IDT	-40°C	85°C
Storage temperature		-65°C	150°C
Lead temperature 1.6mm (1/16 inch) soldering for 10 seconds			260°C

RECOMMENDED OPERATING CONDITIONS

PARAMETER	SYMBOL	TEST CONDITIONS	MIN	TYP	MAX	UNIT
Supply voltage	VDD		2.7		5.5	V
High-level digital input voltage	V _{IH}	VDD = 2.7V to 5.5V	2			V
Low-level digital input voltage	V _{IL}	VDD = 2.7V to 5.5V			0.8	V
Reference voltage to REF	V _{REF}	See Note			VDD - 1.5	V
Load resistance	R _L		2			kΩ
Load capacitance	C _L				100	pF
Operating free-air temperature	T _A	WM2639CDT	0		70	°C
		WM2639IDT	-40		85	°C

Note: Reference voltages greater than VDD/2 will cause output saturation for large DAC codes.

ELECTRICAL CHARACTERISTICS**Test Conditions:**

$R_L = 10k\Omega$, $C_L = 100pF$. $V_{DD} = 5V \pm 10\%$, $V_{REF} = 2.048V$ and $V_{DD} = 3V \pm 10\%$, $V_{REF} = 1.024V$ over recommended operating free-air temperature range (unless noted otherwise)

PARAMETER	SYMBOL	TEST CONDITIONS	MIN	TYP	MAX	UNIT
Static DAC Specifications						
Resolution			12			bits
Integral non-linearity	INL	See Note 1		± 1.2	± 3	LSB
Differential non-linearity	DNL	See Note 2		± 0.3	± 0.5	LSB
Zero code error	ZCE	See Note 3		3	± 20	mV
Gain error	GE	See Note 4			± 0.3	% FSR
d.c. power supply rejection ratio	DC PSRR	See Note 5		0.5		mV/V
Zero code error temperature coefficient		See Note 6		20		ppm/ $^{\circ}C$
Gain error temperature coefficient		See Note 6		20		ppm/ $^{\circ}C$
DAC Output Specifications						
Output voltage range			0		$V_{DD} - 0.4$	V
Output load regulation		2k Ω to 10k Ω load See Note 7		0.1	0.3	%
Power Supplies						
Active supply current	I_{DD}	No load, $V_{IH} = V_{DD}$, $V_{IL} = 0V$ $V_{DD} = 5V$, $V_{REF} = 2.048V$, Internal Slow Fast $V_{DD} = 5V$, $V_{REF} = 2.048V$, External Slow Fast $V_{DD} = 3V$, $V_{REF} = 1.024V$, Internal Slow Fast $V_{DD} = 3V$, $V_{REF} = 1.024V$, External Slow Fast See Note 8		1.3 2.3 0.9 1.9 1.2 2.1 0.9 1.8	1.6 2.8 1.2 2.4 1.5 2.6 1.1 2.3	mA mA mA mA mA mA mA mA
Power down supply current		No load, all inputs 0V or VDD See Note 9		0.01	1	μA
Dynamic DAC Specifications						
Slew rate		DAC code 32-4095, 10%-90% Slow Fast See Note 10	1.2 6.0	1.7 10		V/ μs V/ μs
Settling time		DAC code 32-4095 Slow Fast See Note 11		3.5 1		μs μs
Glitch energy		Code 2047 to 2048		5		nV-s

Test Conditions:

$R_L = 10k\Omega$, $C_L = 100pF$. $V_{DD} = 5V \pm 10\%$, $V_{REF} = 2.048V$ and $V_{DD} = 3V \pm 10\%$, $V_{REF} = 1.024V$ over recommended operating free-air temperature range (unless noted otherwise)

PARAMETER	SYMBOL	TEST CONDITIONS	MIN	TYP	MAX	UNIT
Signal to noise ratio	SNR	$f_s = 480ksp/s$, $f_{OUT} = 1kHz$, $BW = 20kHz$, $T_A = 25^\circ C$ See Note 12	73	78		dB
Signal to noise and distortion ratio	SNRD	$f_s = 480ksp/s$, $f_{OUT} = 1kHz$, $BW = 20kHz$, $T_A = 25^\circ C$ See Note 12	61	67		dB
Total harmonic distortion	THD	$f_s = 480ksp/s$, $f_{OUT} = 1kHz$, $BW = 20kHz$, $T_A = 25^\circ C$ See Note 12		-69	-62	dB
Spurious free dynamic range	SPFDR	$f_s = 480ksp/s$, $f_{OUT} = 1kHz$, $BW = 20kHz$, $T_A = 25^\circ C$ See Note 12	63	74		dB
Reference configured as input						
Reference input resistance	R_{REFIN}			10		$M\Omega$
Reference input capacitance	C_{REFIN}			55		pF
Reference feedthrough		$V_{REF} = 1V_{PP}$ at 1kHz + 1.024Vdc, DAC code 0		-60		dB
Reference input bandwidth		$V_{REF} = 0.2V_{PP} + 1.024V$ d.c. DAC code 2048 Slow Fast		500 900		kHz kHz
Reference configured as output						
Low reference voltage	$V_{REFOUTL}$		1.003	1.024	1.045	V
High reference voltage	$V_{REFOUTH}$	$V_{DD} > 4.75V$	2.027	2.048	2.069	V
Output source current	I_{REFSRC}				1	mA
Output sink current	I_{REFSNK}		-1			mA
Load Capacitance					100	pF
PSRR				-48		dB
Digital Inputs						
High level input current	I_{IH}	Input voltage = V_{DD}			1	μA
Low level input current	I_{IL}	Input voltage = 0V			-1	μA
Input capacitance	C_I			8		pF

Notes:

- Integral non-linearity (INL)** is the maximum deviation of the output from the line between zero and full scale (excluding the effects of zero code and full scale errors).
- Differential non-linearity (DNL)** is the difference between the measured and ideal 1LSB amplitude change of any adjacent two codes. A guarantee of monotonicity means the output voltage changes in the same direction (or remains constant) as a change in digital input code.
- Zero code error** is the voltage output when the DAC input code is zero.
- Gain error** is the deviation from the ideal full scale output excluding the effects of zero code error.
- Power supply rejection ratio** is measured by varying V_{DD} from 4.5V to 5.5V and measuring the proportion of this signal imposed on the zero code error and the gain error.
- Zero code error** and **Gain error** temperature coefficients are normalised to full scale voltage.
- Output load regulation** is the difference between the output voltage at full scale with a 10k Ω load and 2k Ω load. It is expressed as a percentage of the full scale output voltage with a 10k Ω load.
- I_{DD} is measured while continuously writing code 2048 to the DAC. For $V_{IH} < V_{DD} - 0.7V$ and $V_{IL} > 0.7V$ supply current will increase.
- Typical supply current** in power down mode is 10nA. Production test limits are wider for speed of test.
- Slew rate** results are for the lower value of the rising and falling edge slew rates.
- Settling time** is the time taken for the signal to settle to within 0.5LSB of the final measured value for both rising and falling edges. Limits are ensured by design and characterisation, but are not production tested.

12. SNR, SNRD, THD and SPFDR are measured on a synthesised sine wave at frequency f_{OUT} generated with a sampling frequency f_s .

SERIAL INTERFACE

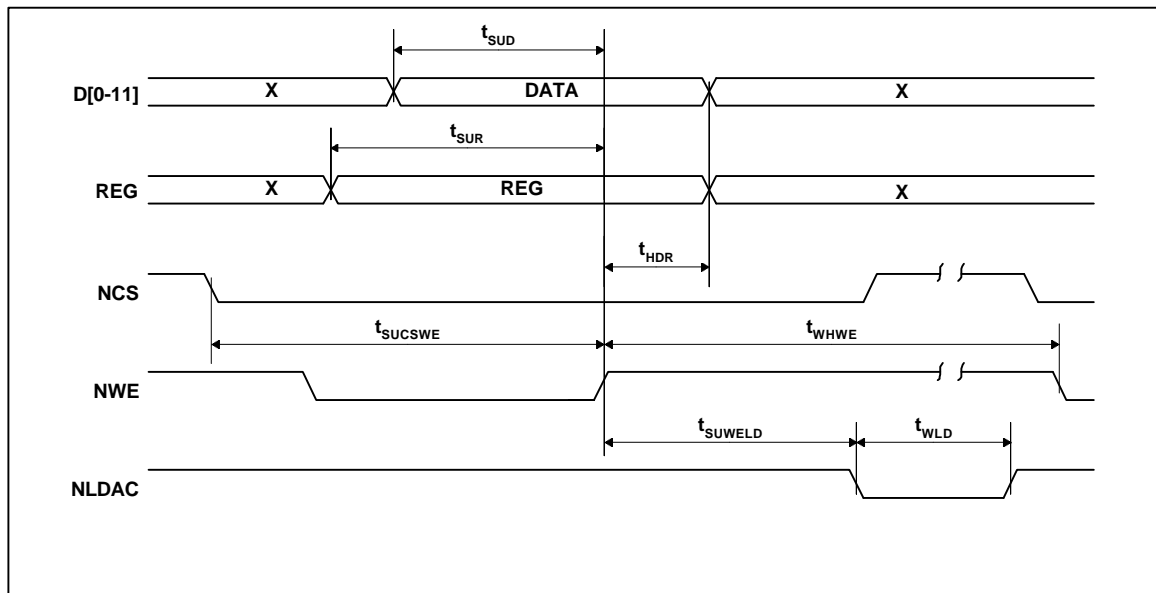

Figure 1 Timing Diagram

Test Conditions:

$R_L = 10k\Omega$, $C_L = 100pF$. $V_{DD} = 5V \pm 10\%$, $V_{REF} = 2.048V$ and $V_{DD} = 3V \pm 10\%$, $V_{REF} = 1.024V$ over recommended operating free-air temperature range (unless noted otherwise)

SYMBOL	TEST CONDITIONS	MIN	TYP	MAX	UNIT
t_{SUCSWE}	Setup time NCS low before positive NWE edge	15			ns
t_{SUD}	Setup time data ready before positive NWE edge	10			ns
t_{SUR}	Setup time REG ready before positive NWE edge	20			ns
t_{HDR}	Data and REG hold after positive NWE edge	5			ns
t_{SUWELD}	Setup time NWE high before NLDAC low	5			ns
t_{WHWE}	High pulse width of NWE	20			ns
t_{WLD}	Low pulse width of NLDAC	23			ns

TYPICAL PERFORMANCE GRAPHS

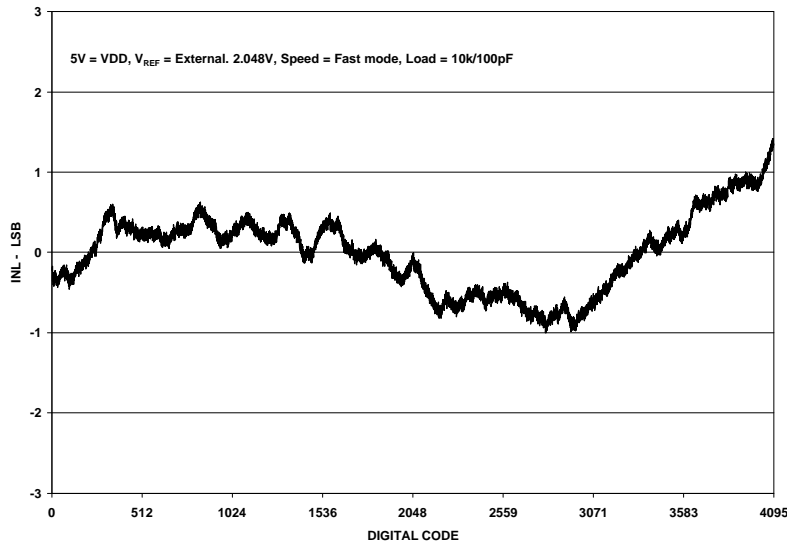

Figure 2 Integral Non-Linearity

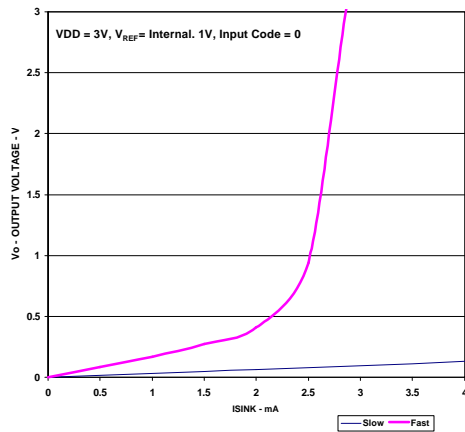

Figure 3 Sink Current VDD = 3V

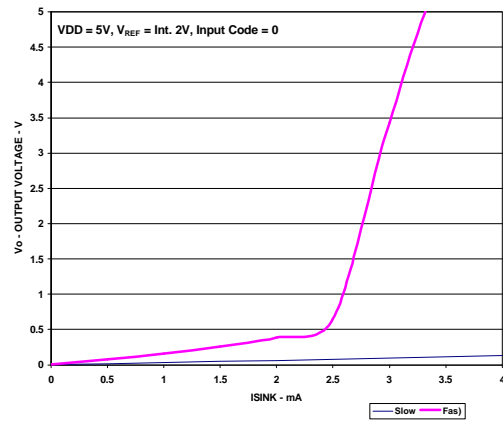

Figure 4 Sink Current VDD = 5V

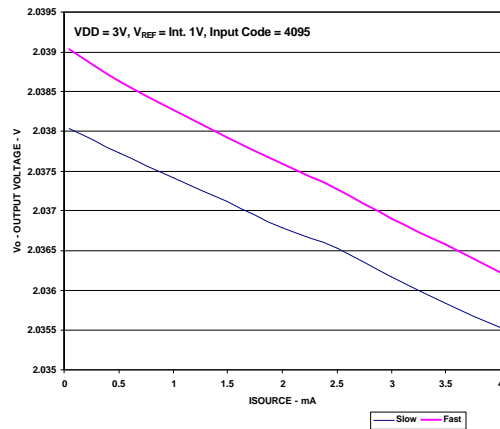

Figure 5 Source Current VDD = 3V

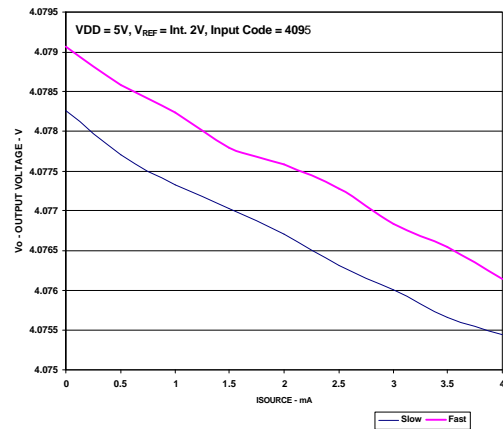

Figure 6 Source Current VDD = 5V

DEVICE DESCRIPTION

GENERAL FUNCTION

The device uses a resistor string network buffered with an op amp to convert 12-bit digital data to analogue voltage levels (see Block Diagram). The output voltage is determined by the reference input voltage and the input code according to the following relationship:

$$\text{Output voltage} = 2(V_{\text{REF}}) \frac{\text{CODE}}{4096}$$

INPUT			OUTPUT
1111	1111	1111	$2(V_{\text{REF}}) \frac{4095}{4096}$
	:		:
1000	0000	0001	$2(V_{\text{REF}}) \frac{2049}{4096}$
1000	0000	0000	$2(V_{\text{REF}}) \frac{2048}{4096} = V_{\text{REF}}$
0111	1111	1111	$2(V_{\text{REF}}) \frac{2047}{4096}$
	:		:
0000	0000	0001	$2(V_{\text{REF}}) \frac{1}{4096}$
0000	0000	0000	0V

Table 1 Binary Code Table (0V to 2V_{REF} Output), Gain = 2

POWER ON RESET

An internal power-on-reset circuit resets the DAC register to all 0s on power-up.

BUFFER AMPLIFIER

The output buffer has a near rail-to-rail output with short circuit protection and can reliably drive a 2kΩ load with a 100pF load capacitance.

HARDWARE CONFIGURATION OPTIONS

The WM2639 has one configuration option that is controlled by a device pin.

DAC UPDATE

The NLDAC pin (Pin 16) can be held high to prevent word writes from updating the DAC latch. By writing the new value to the DAC then pulling NLDAC low, the new DAC code is loaded into the DAC latch.

PARALLEL INTERFACE

The device registers data on the positive edge of NWE (Pin 17). It must be enabled with NCS (Pin 18) low. Whether the data is written to the DAC holding latch or the control register, depends on the state of input pin REG (Pin 15). REG = 0 selects the DAC holding latch, REG = 1 selects the control register.

SOFTWARE CONFIGURATION OPTIONS

DATA FORMAT

The WM2639 writes data either to the DAC holding latch or to the control register depending on the state of input pin REG.

REG (PIN 15)	DATA DESTINATION
0	DAC holding latch
1	Control register

D11	D10	D9	D8	D7	D6	D5	D4	D3	D2	D1	D0
X	X	X	X	X	X	X	REF1	REF0	X	PWR	SPD

Table 1 Register Bits

PROGRAMMABLE SETTLING TIME

Settling time is a software selectable 3.5 μ s or 1 μ s, typical to within ± 0.5 LSB of final value. This is controlled by the value of SPD – Bit D0. A ONE defines a settling time of 1 μ s, a ZERO (default) defines a settling time of 3.5 μ s.

PROGRAMMABLE POWER DOWN

The power down function can be controlled by PWR. A ZERO configures the device as active, or fully powered up, a ONE configures the device into power down mode. When the power down function is released the device reverts to the DAC code set prior to power down.

PROGRAMMABLE INTERNAL REFERENCE

The reference can be sourced internally or externally under software control. If an external reference voltage is applied to the REF pin, the device must be configured to accept this.

If an external reference is selected, the reference voltage input is buffered which makes the DAC input resistance independent of code. The REF pin has an input resistance of 10M Ω and an input capacitance of typically 55pF. The reference voltage determines the DAC full-scale output.

If an internal reference is selected, a voltage of 1.024V or 2.048 is available. The internal reference can source up to 1mA and can therefore be used as an external system reference.

REF1	REF0	REFERENCE
0	0	External (default)
0	1	1.024V
1	0	2.048V
1	1	External

Table 2 Programmable Internal Reference

PACKAGE DIMENSIONS

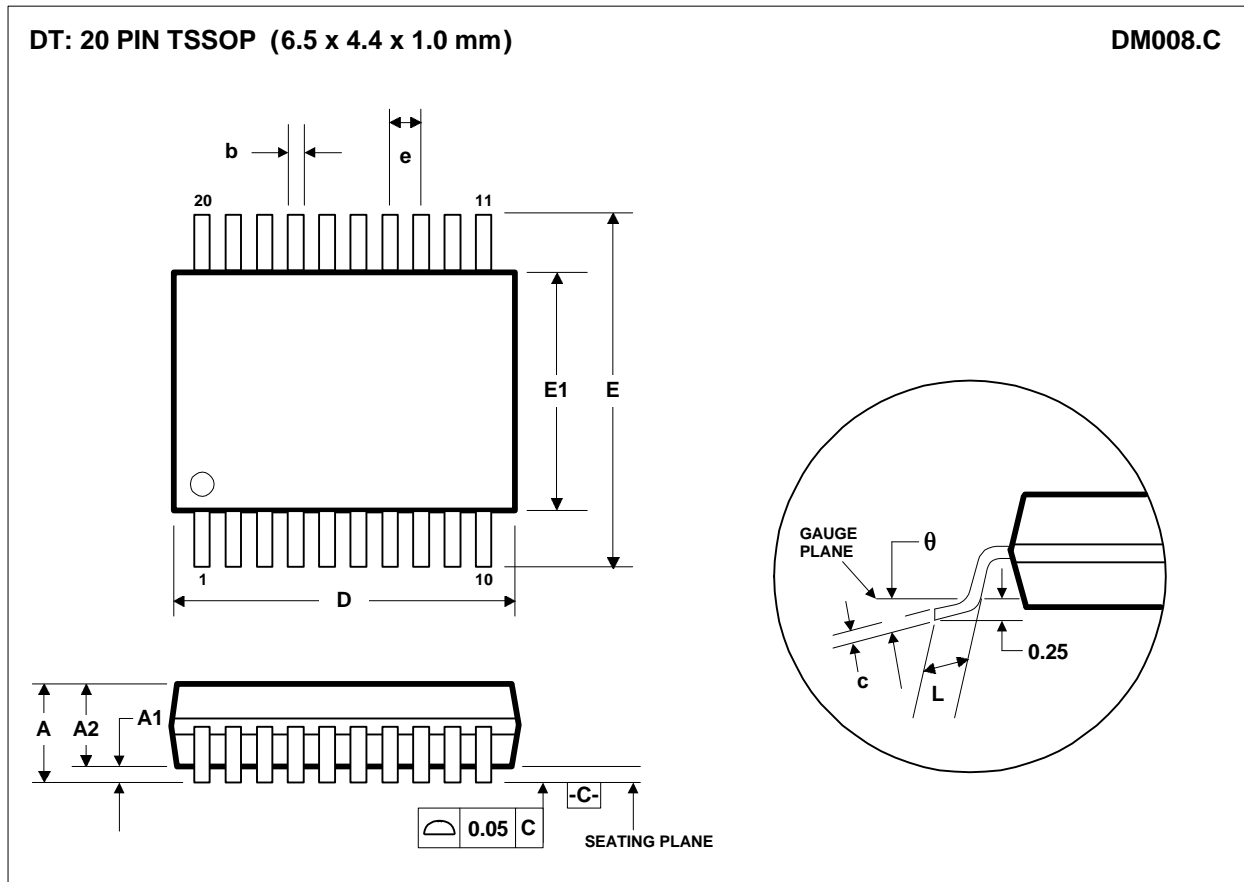

Symbols	Dimensions (mm)		
	MIN	NOM	MAX
A	----	----	1.20
A₁	0.05	----	0.15
A₂	0.80	1.00	1.05
b	0.19	----	0.30
c	0.09	----	0.20
D	6.40	6.50	6.60
e	0.65 BSC		
E	6.4 BSC		
E₁	4.30	4.40	4.50
L	0.45	0.60	0.75
θ	0°		8
REF:			

- NOTES:
 A. ALL LINEAR DIMENSIONS ARE IN MILLIMETERS.
 B. THIS DRAWING IS SUBJECT TO CHANGE WITHOUT NOTICE.
 C. BODY DIMENSIONS DO NOT INCLUDE MOLD FLASH OR PROTRUSION, NOT TO EXCEED 0.25MM.
 D. MEETS JEDEC.95 MO-153, VARIATION = AC. REFER TO THIS SPECIFICATION FOR FURTHER DETAILS.