

600V 1.0Ω Super Junction Power MOSFET

Description

WMOS™ VD is Wayon's new high voltage power MOSFET family that is utilizing advanced technology for extremely low on-resistance and low gate charge performance. WMOS™ VD is suitable for applications which require superior power density and outstanding efficiency.

Features

- $V_{DS} = 650V @ T_{j,max}$
- $I_{DM} = 10.5A$
- Typ. $R_{DS(on)} = 1.0\Omega$
- 100% UIS tested
- Pb-free plating, Halogen free

Applications

LED Lighting, Charger, Adapter, PC, LCD TV, Server

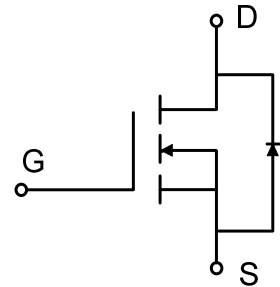
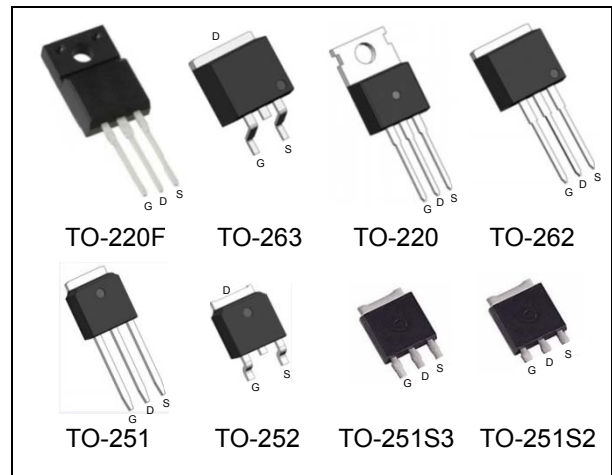

Absolute Maximum Ratings

Parameter	Symbol	WMH_M_O_P_G_N_K	WML	Unit
Drain-source voltage	V_{DSS}	600		V
Continuous drain current ¹⁾ ($T_C = 25^\circ C$)	I_D	6.5		A
		3		A
Pulsed drain current ²⁾	I_{DM}	10.5		A
Gate-source voltage	V_{GS}	± 30		V
Avalanche energy, single pulse ³⁾	E_{AS}	15		mJ
Avalanche energy, repetitive ²⁾	E_{AR}	0.1		mJ
Avalanche current, repetitive ²⁾	I_{AR}	0.7		A
Power dissipation ($T_C = 25^\circ C$)	P_D	42	23	W
Operating and storage temperature range	T_i, T_{stg}	-55 to +150		$^\circ C$
Continuous diode forward current ¹⁾	I_S	6.5		A
Diode pulse current ²⁾	$I_{S,pulse}$	10.5		A

Thermal Characteristics

Parameter	Symbol	WMH_M_O_P_G_N_K	WML	Unit
Thermal resistance, junction-to-case	$R_{\theta JC}$	3	5.4	$^\circ C/W$
Thermal resistance, junction-to-ambient	$R_{\theta JA}$	62	80	$^\circ C/W$

Electrical Characteristics $T_c = 25^\circ\text{C}$, unless otherwise noted

Parameter	Symbol	Test Condition	Min.	Typ.	Max.	Unit
Static characteristics						
Drain-source breakdown voltage	BV_{DSS}	$V_{GS}=0\text{ V}, I_D=0.25\text{ mA}$	600	-	-	V
Gate threshold voltage	$V_{GS(th)}$	$V_{DS}=V_{GS}, I_D=0.25\text{ mA}$	2.5	3.3	4.5	V
Drain cut-off current	I_{DSS}	$V_{DS}=600\text{ V}, V_{GS}=0\text{ V},$ $T_j = 25^\circ\text{C}$ $T_j = 125^\circ\text{C}$	-	-	1	μA
Gate leakage current, forward	I_{GSSF}	$V_{GS}=30\text{ V}, V_{DS}=0\text{ V}$	-	-	100	nA
Gate leakage current, reverse	I_{GSSR}	$V_{GS}=-30\text{ V}, V_{DS}=0\text{ V}$	-	-	-100	nA
Drain-source on-state resistance	$R_{DS(on)}$	$V_{GS}=10\text{ V}, I_D=1\text{ A}$ $T_j = 25^\circ\text{C}$	-	1.0	1.13	Ω
Dynamic characteristics						
Input capacitance	C_{iss}	$V_{DS}=25\text{ V}, V_{GS}=0\text{ V},$	-	299	-	pF
Output capacitance	C_{oss}	$f = 1\text{ MHz}$	-	265	-	
Reverse transfer capacitance	C_{rss}		-	3	-	
Turn-on delay time	$t_{d(on)}$	$V_{DD} = 300\text{ V}, I_D = 2\text{ A}$	-	5	-	ns
Rise time	t_r	$R_G = 25\Omega, V_{GS}=10\text{ V}$	-	16	-	
Turn-off delay time	$t_{d(off)}$		-	24	-	
Fall time	t_f		-	12	-	
Gate charge characteristics						
Gate to source charge	Q_{gs}	$V_{DD}=480\text{ V}, I_D=2\text{ A},$	-	1.6	-	nC
Gate to drain charge	Q_{gd}	$V_{GS}=0\text{ to }10\text{ V}$	-	1.7	-	
Gate charge total	Q_g		-	5.8	-	
Gate plateau voltage	$V_{plateau}$		-	5	-	V
Reverse diode characteristics						
Diode forward voltage	V_{SD}	$V_{GS}=0\text{ V}, I_F=2\text{ A}$	-	-	1.2	V
Reverse recovery time	t_{rr}	$V_R=50\text{ V}, I_F=2\text{ A},$	-	163	-	ns
Reverse recovery charge	Q_{rr}	$dI_F/dt=100\text{ A}/\mu\text{s}$	-	0.84	-	μC
Peak reverse recovery current	I_{rrm}		-	10.3	-	A

Notes:

- Limited by $T_{j\text{max}}$. Maximum duty cycle $D=0.5$.
- Repetitive rating: pulse width limited by maximum junction temperature
- $I_{AS} = 0.7\text{ A}, V_{DD} = 50\text{ V}, R_G = 25\Omega$, starting $T_j = 25^\circ\text{C}$

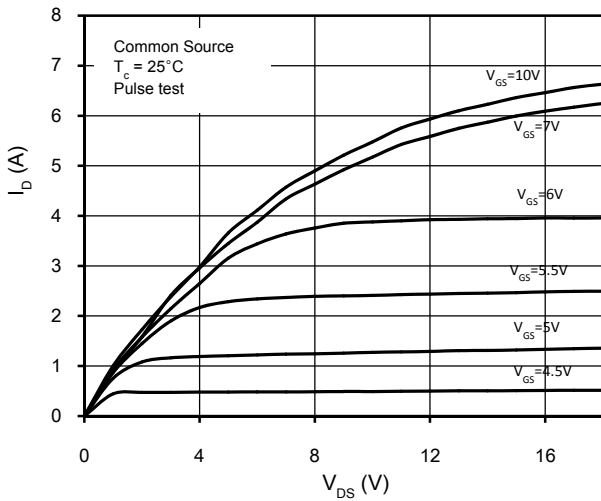

Figure 1. On-Region Characteristics

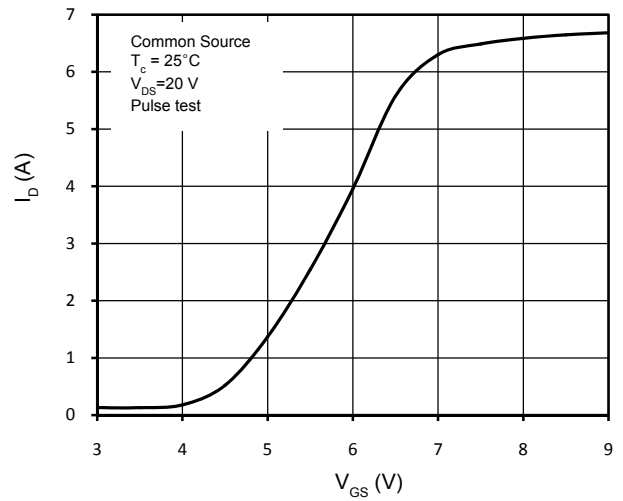

Figure 2. Transfer Characteristics

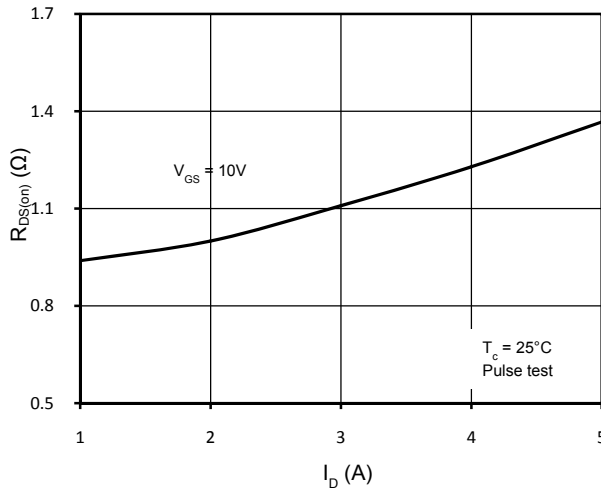

Figure 3. Static Drain-Source On Resistance

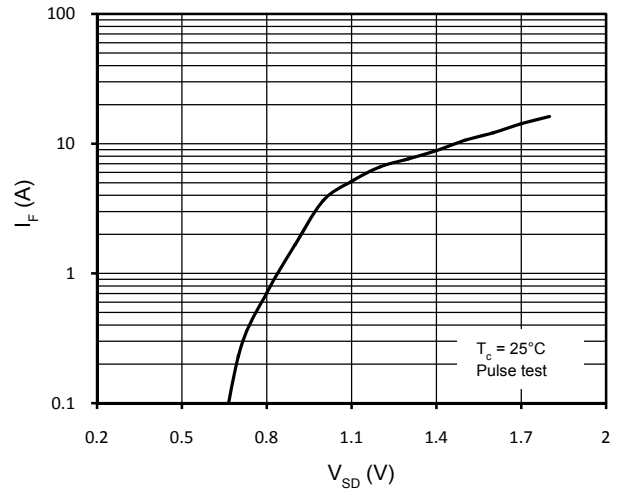

Figure 4. Body-Diode Forward Characteristics

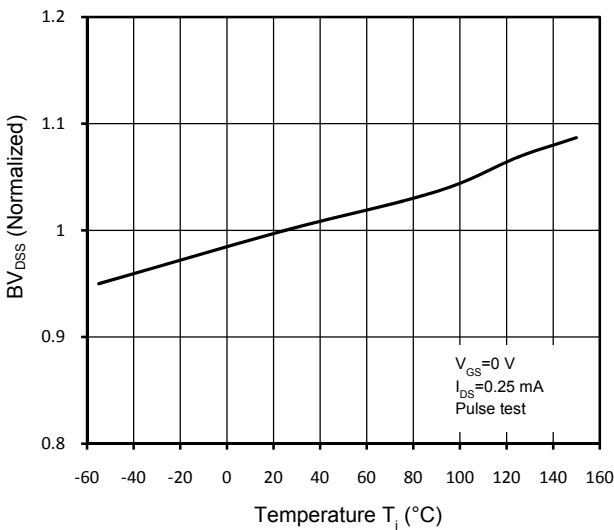

Figure 5. Normalized BV_{DS} vs. Temperature

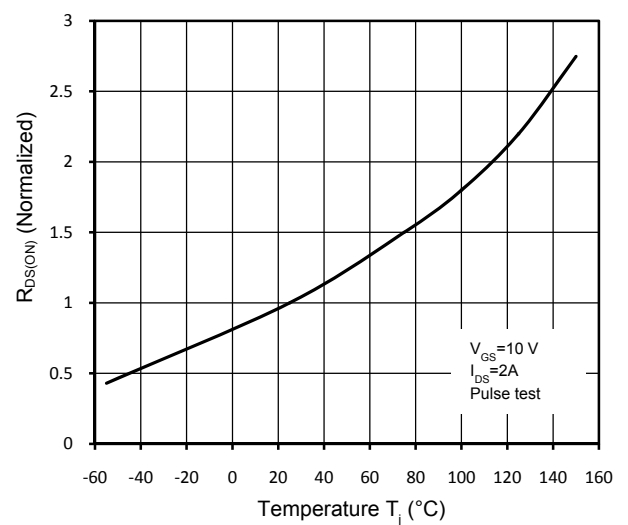

Figure 6. Normalized $R_{DS(on)}$ vs. Temperature

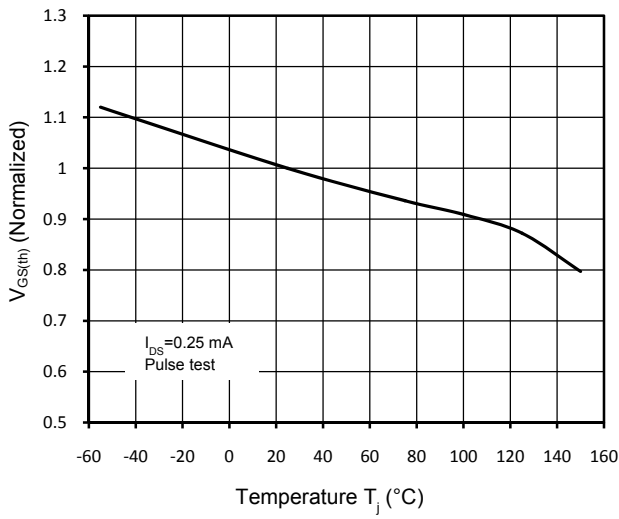

Figure 7. Threshold Voltage vs. Temperature

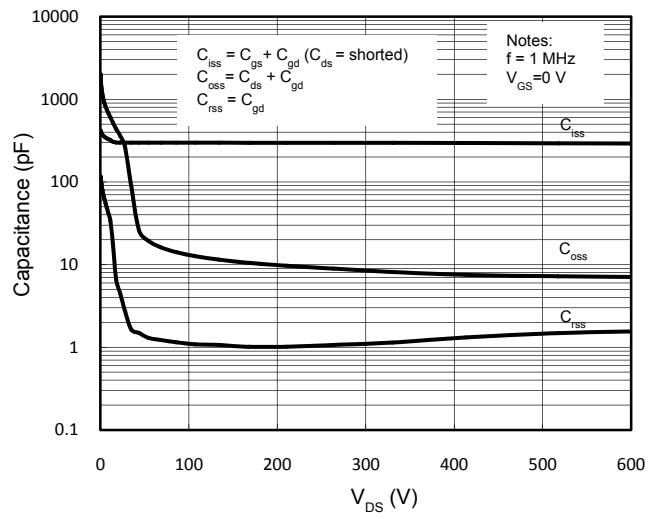

Figure 8. Capacitance Characteristics

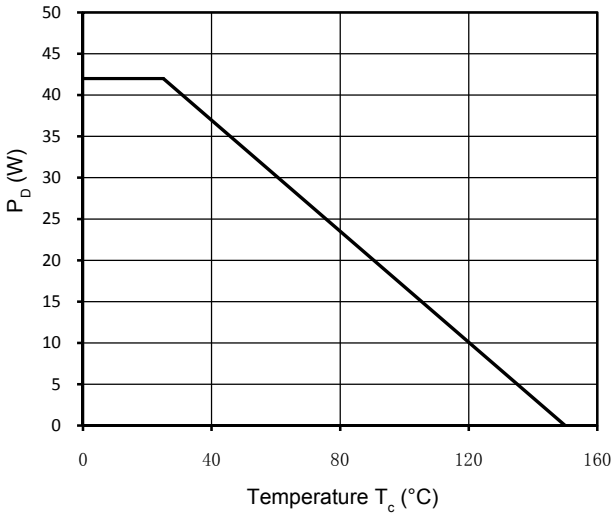

Figure 9. Power Dissipation

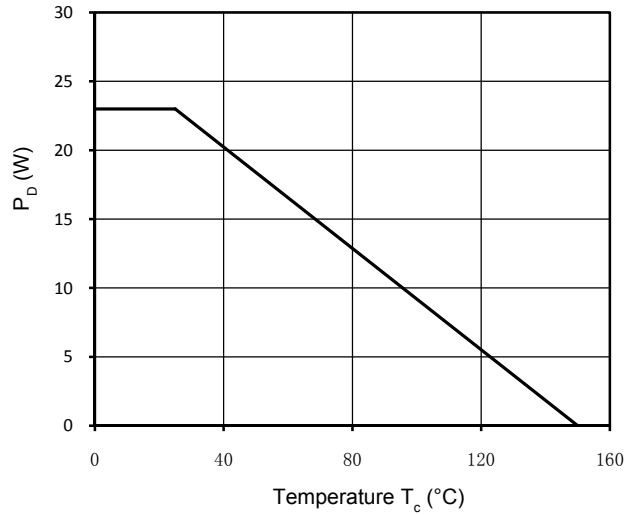

Figure 10. Power Dissipation (TO-220F)

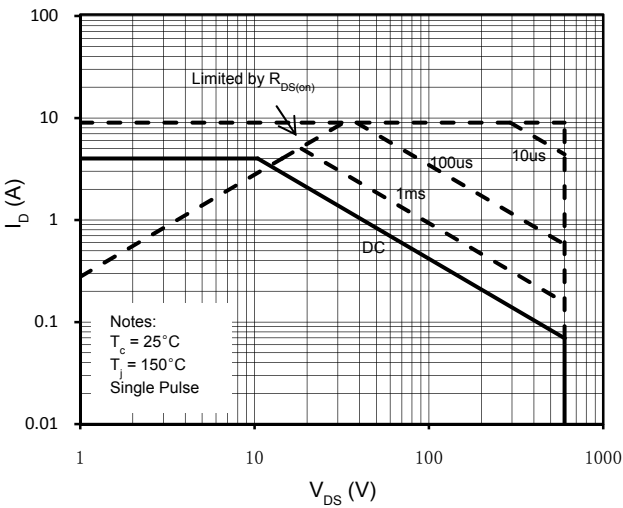

Figure 11. Maximum Safe Operating Area

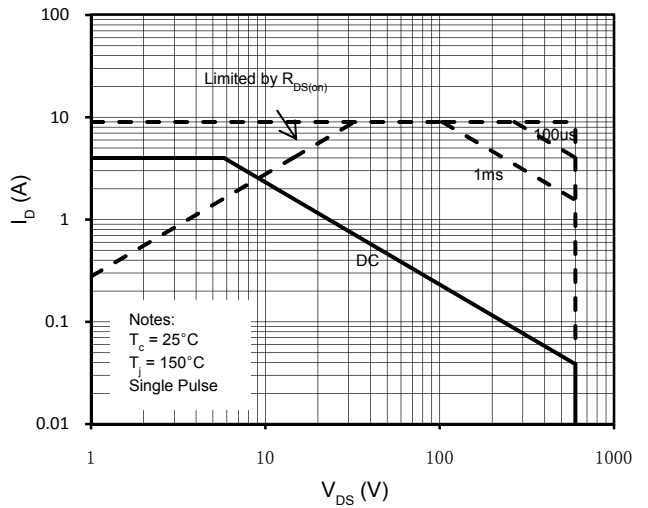

Figure 12. Maximum Safe Operating Area (TO-220F)

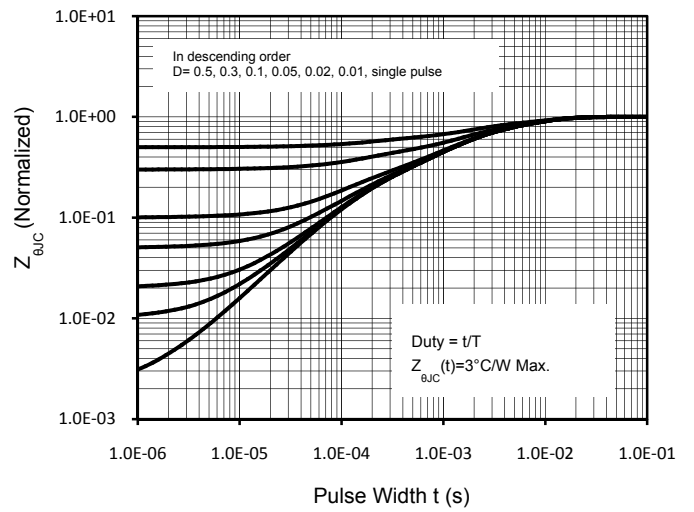
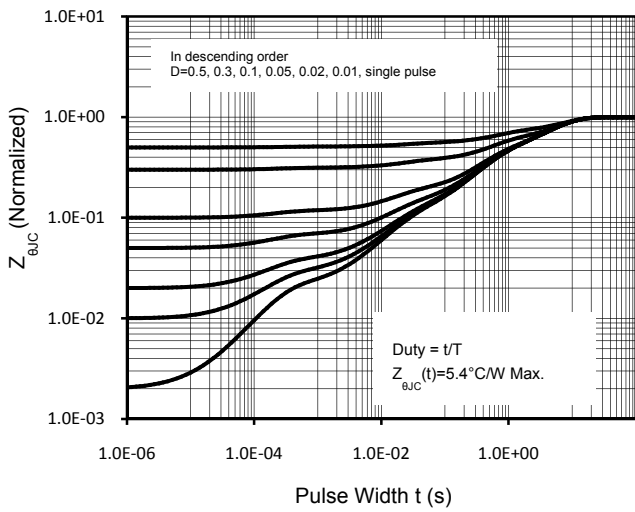

Figure 13. Transient Thermal Response Curve (TO-220F) Figure 14. Transient Thermal Response Curve

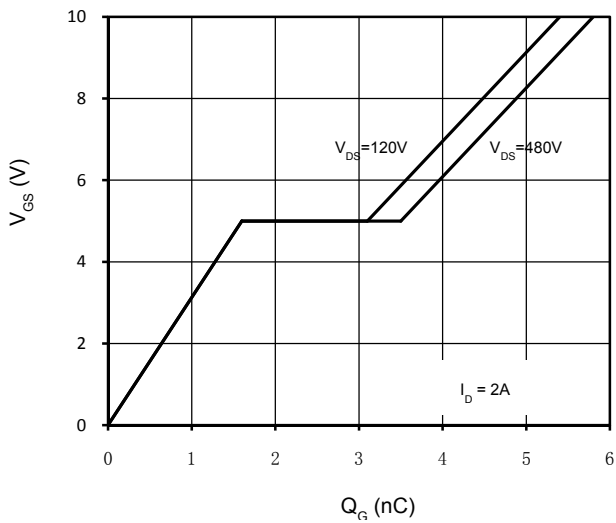

Figure 15. Gate Charge Characteristics

Gate Charge Test Circuit & Waveform



Switching Test Circuit & Waveforms



Unclamped Inductive Switching Test Circuit & Waveforms



Mechanical Dimensions for TO-220F

COMMON DIMENSIONS

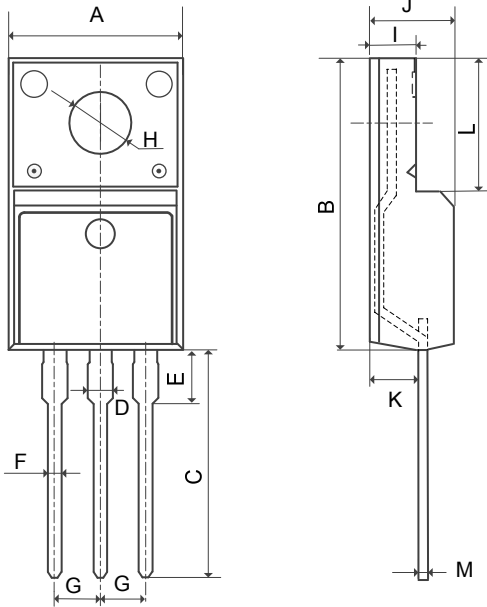

SYMBOL	MM	
	MIN	MAX
A	9.96	10.36
B	15.67	16.07
C	12.70	13.30
D	1.12	1.32
E	1.85	2.15
F	0.59	0.79
G	2.39	2.69
H	3.08	3.29
I	2.34	2.74
J	4.50	4.90
K	2.61	2.91
L	6.50	6.90
M	0.40	0.60

Mechanical Dimensions for TO-263

COMMON DIMENSIONS

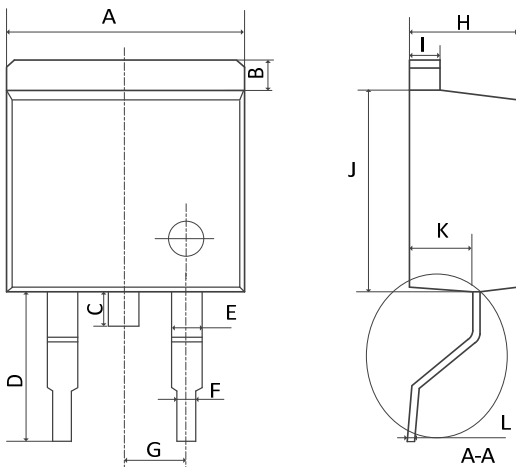

SYMBOL	MM	
	MIN	MAX
A	10.00	10.40
B	1.11	1.41
C	1.25	1.55
D	5.10	5.50
E	1.12	1.42
F	0.71	0.92
G	2.39	2.69
H	4.49	4.89
I	1.17	1.37
J	8.45	8.85
K	2.54	2.84
L	0.28	0.49

Mechanical Dimensions for TO-251



COMMON DIMENSIONS

SYMBOL	MM	
	MIN	MAX
A	6.40	6.80
B	5.13	5.46
C	0.88	1.28
D	5.90	6.22
E	0.68	1.10
F	0.68	0.91
G	2.29REF	
H	9.00	9.65
I	0.90	1.17
J	0.40	0.61
K	2.10	2.50

Mechanical Dimensions for TO-252

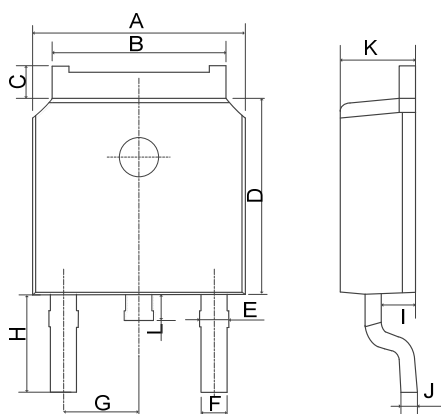

COMMON DIMENSIONS

SYMBOL	MM	
	MIN	MAX
A	6.40	6.80
B	5.13	5.50
C	0.88	1.28
D	5.90	6.22
E	0.68	1.10
F	0.68	0.91
G	2.29REF	
H	2.90REF	
I	0.85	1.17
J	0.51REF	
K	2.10	2.50
L	0.40	1.00

Mechanical Dimensions for TO-262

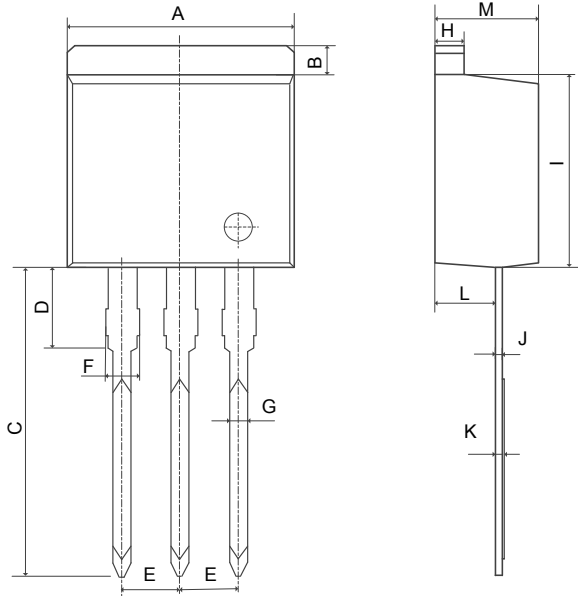

COMMON DIMENSIONS

SYMBOL	MM	
	MIN	MAX
A	10.00	10.40
B	1.11	1.41
C	13.56	14.16
D	3.58	3.98
E	2.39	2.69
F	1.07	1.47
G	0.71	0.92
H	1.17	1.37
I	8.45	8.85
J	0.28	0.49
K	0.32	0.52
L	2.54	2.85
M	4.50	4.90

Mechanical Dimensions for TO-220

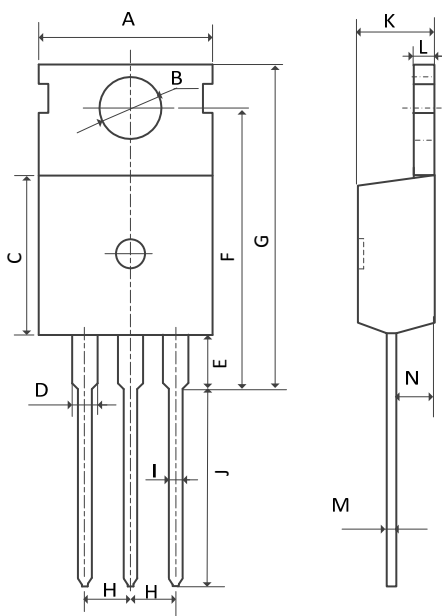

COMMON DIMENSIONS

SYMBOL	MM	
	MIN	MAX
A	9.70	10.20
B	3.40	3.80
C	8.90	9.40
D	1.17	1.47
E	2.60	3.40
F	15.10	16.70
G	19.55MAX	
H	2.54REF	
I	0.70	0.95
J	9.35	11.00
K	4.30	4.77
L	1.20	1.45
M	0.40	0.65
N	2.20	2.60

Mechanical Dimensions for TO-251S3

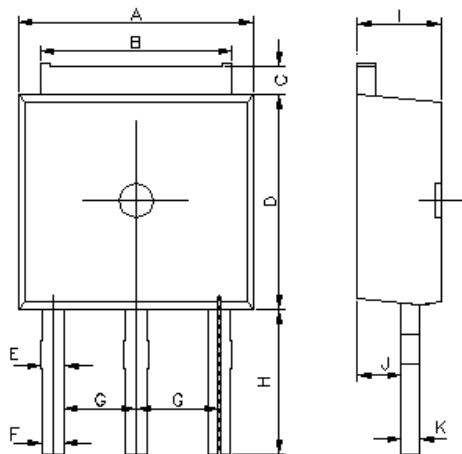

COMMON DIMENSIONS

SYMBOL	MM	
	MIN	MAX
A	6.40	6.80
B	5.15	5.48
C	0.71	1.02
D	5.95	6.35
E	0.70	1.00
F	0.70	0.90
G	2.13	2.44
H	3.20	3.80
I	2.10	2.50
J	0.85	1.15
K	0.40	0.61

Mechanical Dimensions for TO-251S2

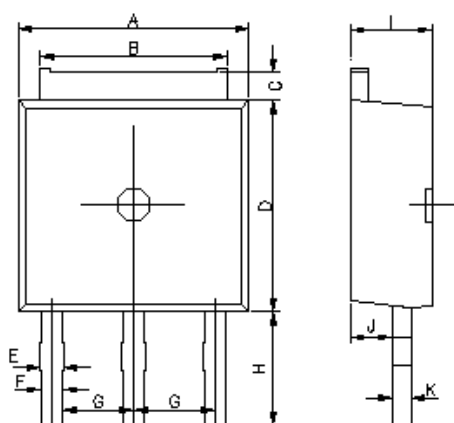

COMMON DIMENSIONS

SYMBOL	MM	
	MIN	MAX
A	6.40	6.80
B	5.15	5.48
C	0.71	1.02
D	5.95	6.35
E	0.70	1.00
F	0.70	0.90
G	2.13	2.44
H	2.20	2.80
I	2.10	2.50
J	0.85	1.15
K	0.40	0.61

Ordering Information

Part	Package	Marking	Packing method
WML09N60VD	TO-220F	WML09N60VD	Tube
WMM09N60VD	TO-263	WMM09N60VD	Tape and Reel
WMK09N60VD	TO-220	WMK09N60VD	Tube
WMN09N60VD	TO-262	WMN09N60VD	Tube
WMO09N60VD	TO-252	WMO09N60VD	Tape and Reel
WMP09N60VD	TO-251	WMP09N60VD	Tube
WMG09N60VD	TO-251S3	WMG09N60VD	Tube
WMH09N60VD	TO-251S2	WMH09N60VD	Tube

Marking Information

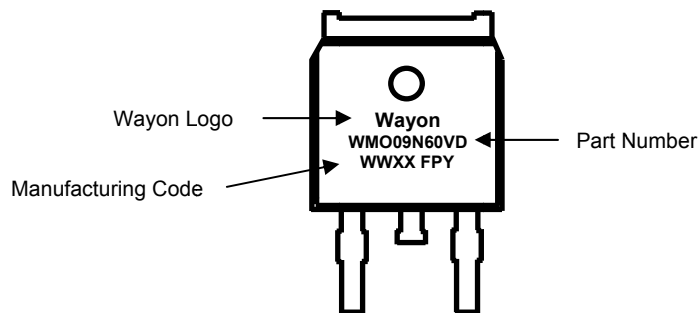

Contact Information

CYG WAYON CIRCUIT PROTECTION CO., LTD.

No.1001, Shiwan(7) Road, Pudong District, Shanghai, P.R.China.201202

Tel: 86-21-50310888 Fax: 86-21-50757680 Email: market@way-on.com

WAYON website: <http://www.way-on.com>

For additional information, please contact your local Sales Representative.

CYG WAYON ® is registered trademarks of Wayon Corporation.

Disclaimer

CYG WAYON reserves the right to make changes without further notice to any Products herein to improve reliability, function, or design. The Products are not designed for use in hostile environments, including, without limitation, aircraft, nuclear power generation, medical appliances, and devices or systems in which malfunction of any Product can reasonably be expected to result in a personal injury. The information given in this document shall in no event be regarded as a guarantee of conditions or characteristics. CYG WAYON does not assume any liability for infringement of patents, copyrights, or other intellectual property rights of third parties by or arising from the use of Products or technical information described in this document.