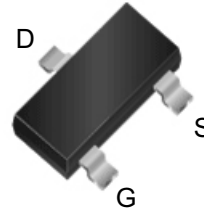
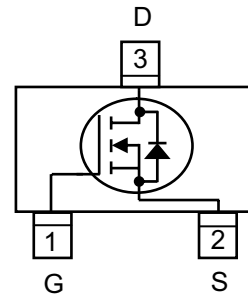
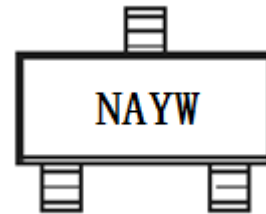

WNM01N10
Single N-Channel, 100V, 1.7A, Power MOSFET
[Http://www.sh-willsemi.com](http://www.sh-willsemi.com)

V _{DS} (V)	Typical R _{ds(on)} (Ω)
100	0.235@ V _{GS} =10V
	0.255@ V _{GS} =4.5V

SOT-23

Pin configuration (Top view)

NA = Device Code
Y = Year
W = Week

Marking
Order information

Device	Package	Shipping
WNM01N10-3/TR	SOT-23	3000/Reel&Tape

Descriptions

The WNM01N10 is N-Channel enhancement MOS Field Effect Transistor. Uses advanced trench technology and design to provide excellent R_{DS(ON)} with low gate charge. This device is suitable for use in DC-DC conversion, power switch and charging circuit. Standard Product WNM01N10 is Pb-free and Halogen-free.

Features

- Trench Technology
- Supper high density cell design
- Excellent ON resistance for higher DC current
- Small package SOT-23

Applications

- Driver for Relay, Solenoid, Motor, LED etc.
- DC-DC converter circuit
- Power Switch
- Load Switch
- Charging

Absolute Maximum ratings

Parameter		Symbol	10 S	Steady State	Unit
Drain-Source Voltage		V_{DS}	100		V
Gate-Source Voltage		V_{GS}	± 20		
Continuous Drain Current ^{a d}	$T_A=25^\circ\text{C}$	I_D	1.70	1.45	A
	$T_A=70^\circ\text{C}$		1.36	1.16	
Maximum Power Dissipation ^{a d}	$T_A=25^\circ\text{C}$	P_D	1.60	1.15	W
	$T_A=70^\circ\text{C}$		1.02	0.74	
Continuous Drain Current ^{b d}	$T_A=25^\circ\text{C}$	I_D	1.50	1.34	A
	$T_A=70^\circ\text{C}$		1.20	1.07	
Maximum Power Dissipation ^{b d}	$T_A=25^\circ\text{C}$	P_D	1.25	1.00	W
	$T_A=70^\circ\text{C}$		0.80	0.64	
Pulsed Drain Current ^c		I_{DM}	7		A
Operating Junction Temperature		T_J	-55 to 150		$^\circ\text{C}$
Lead Temperature		T_L	260		$^\circ\text{C}$
Storage Temperature Range		T_{stg}	-55 to 150		$^\circ\text{C}$

Thermal resistance ratings

Parameter		Symbol	Typical	Maximum	Unit
Junction-to-Ambient Thermal Resistance ^a	$t \leq 10 \text{ s}$	$R_{\theta JA}$	60	78	$^\circ\text{C}/\text{W}$
	Steady State		88	108	
Junction-to-Ambient Thermal Resistance ^b	$t \leq 10 \text{ s}$	$R_{\theta JA}$	85	100	
	Steady State		105	125	
Junction-to-Case Thermal Resistance		$R_{\theta JC}$	60	75	

a Surface mounted on FR-4 Board using 1 square inch pad size, 1oz copper

b Surface mounted on FR-4 board using minimum pad size, 1oz copper

c Pulse width < 380 μs , Duty Cycle < 2%

d Maximum junction temperature $T_J=150^\circ\text{C}$.

Electronics Characteristics (Ta=25°C, unless otherwise noted)

Parameter	Symbol	Test Conditions	Min	Typ	Max	Unit
OFF CHARACTERISTICS						
Drain-to-Source Breakdown Voltage	BV_{DSS}	$V_{GS} = 0V, I_D = 250\mu A$	100			V
Zero Gate Voltage Drain Current	I_{DSS}	$V_{DS} = 80V, V_{GS} = 0V$			1	μA
Gate-to-source Leakage Current	I_{GSS}	$V_{DS} = 0V, V_{GS} = \pm 20V$			± 100	nA
ON CHARACTERISTICS						
Gate Threshold Voltage	$V_{GS(TH)}$	$V_{GS} = V_{DS}, I_D = 250\mu A$	1	1.9	2.5	V
Drain-to-source On-resistance ^{b, c}	$R_{DS(on)}$	$V_{GS} = 10V, I_D = 1.4A$		235	310	m Ω
		$V_{GS} = 4.5V, I_D = 1.3A$		255	350	
Forward Trans conductance	g_{fs}	$V_{DS} = 10V, I_D = 3A$		1.1		S
CAPACITANCES, CHARGES						
Input Capacitance	C_{ISS}	$V_{GS} = 0V,$ $f = 1.0\text{ MHz},$ $V_{DS} = 25V$		350		pF
Output Capacitance	C_{OSS}			23.6		
Reverse Transfer Capacitance	C_{RSS}			14.2		
Total Gate Charge	$Q_{G(TOT)}$	$V_{GS} = 4.5V,$ $V_{DS} = 50V,$ $I_D = 1.6A$		3.6		nC
Threshold Gate Charge	$Q_{G(TH)}$			0.7		
Gate-to-Source Charge	Q_{GS}			1.1		
Gate-to-Drain Charge	Q_{GD}			1.6		
SWITCHING CHARACTERISTICS						
Turn-On Delay Time	$t_d(ON)$	$V_{GS} = 4.5V,$ $V_{DD} = 50V,$ $R_L = 17\Omega, I_D = 3A$ $R_G = 3.3\Omega$		5.2		ns
Rise Time	t_r			17.2		
Turn-Off Delay Time	$t_d(OFF)$			23.3		
Fall Time	t_f			6.6		
BODY DIODE CHARACTERISTICS						
Forward Voltage	V_{SD}	$V_{GS} = 0V, I_S = 1A$		0.8	1.2	V

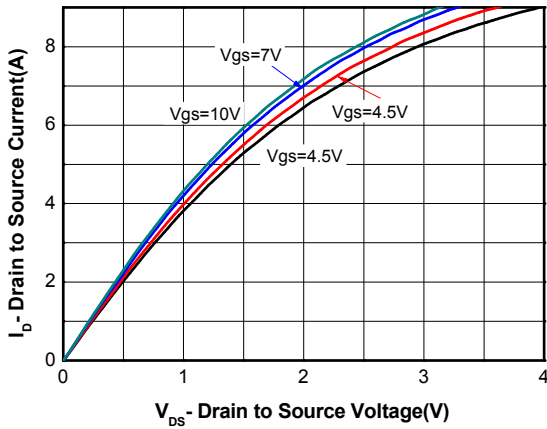
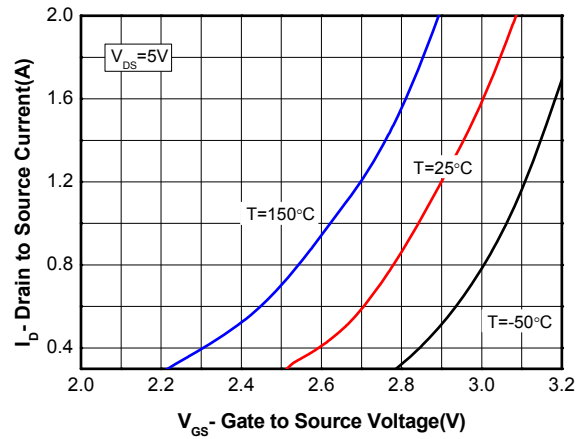
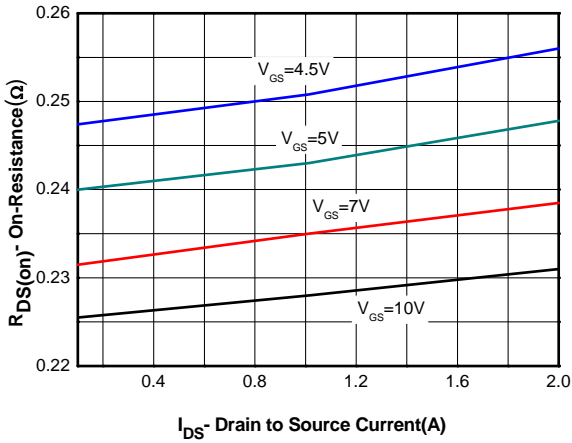
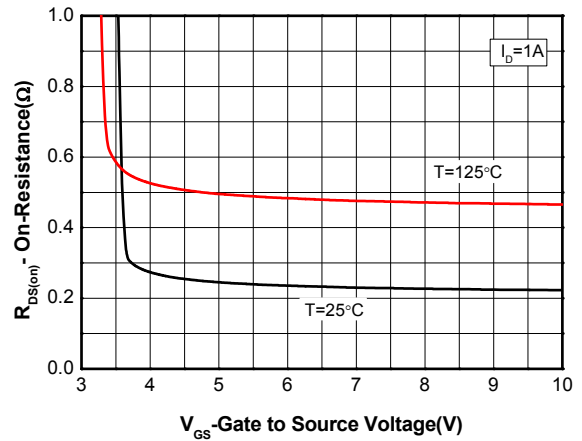
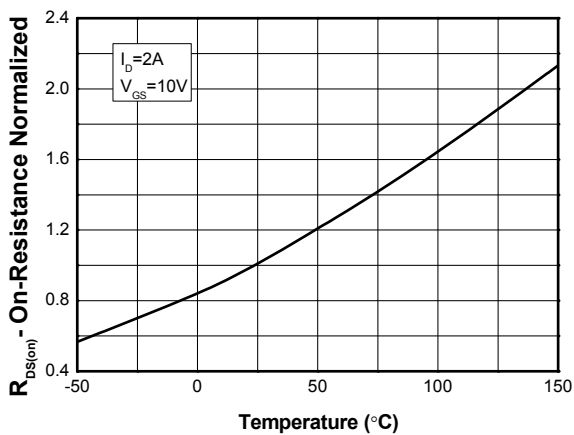
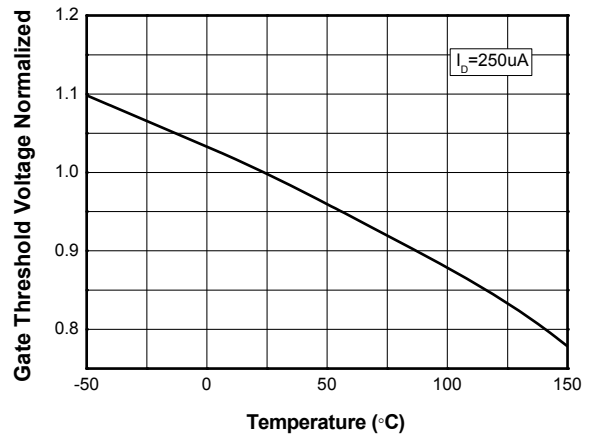
Typical Characteristics (Ta=25°C, unless otherwise noted)

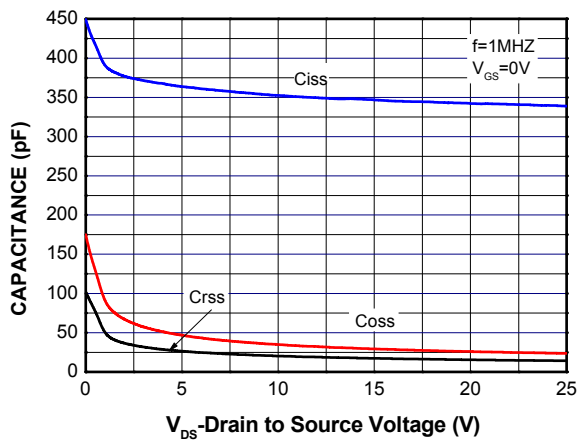
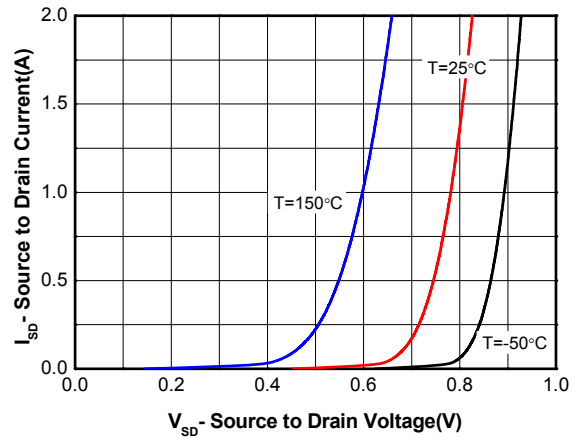
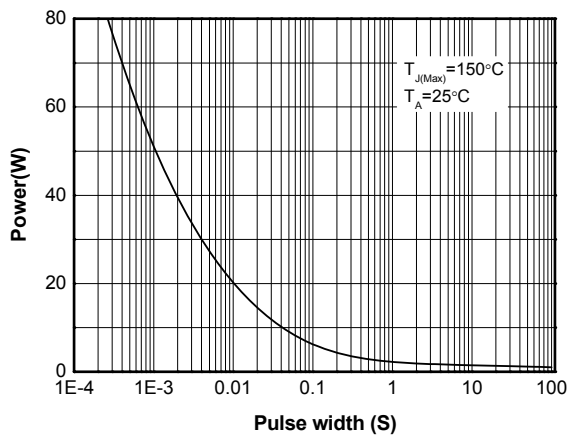
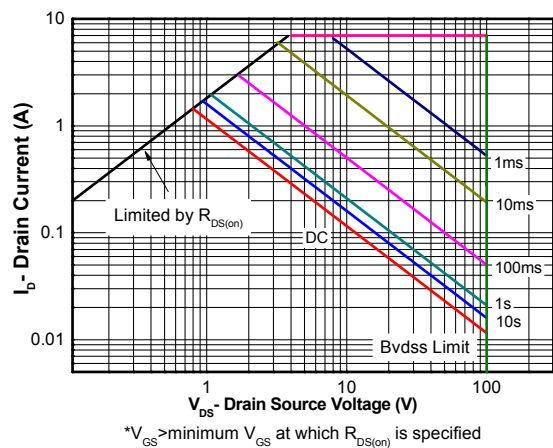
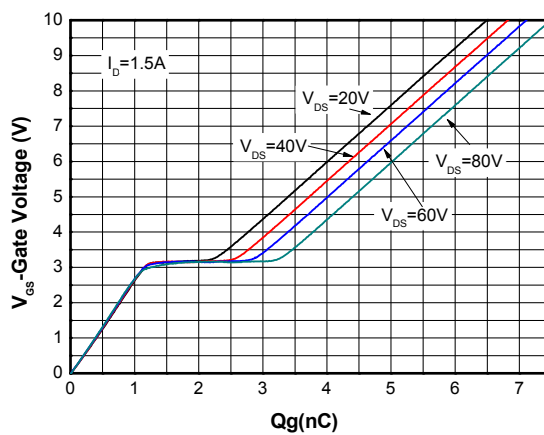
Output characteristics

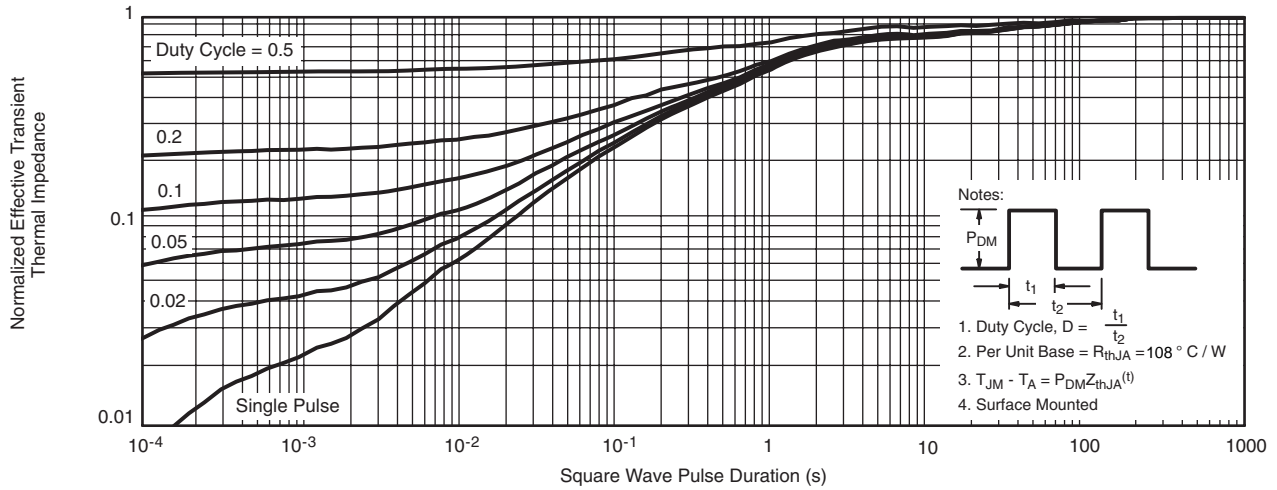
Transfer characteristics

On-Resistance vs. Drain current

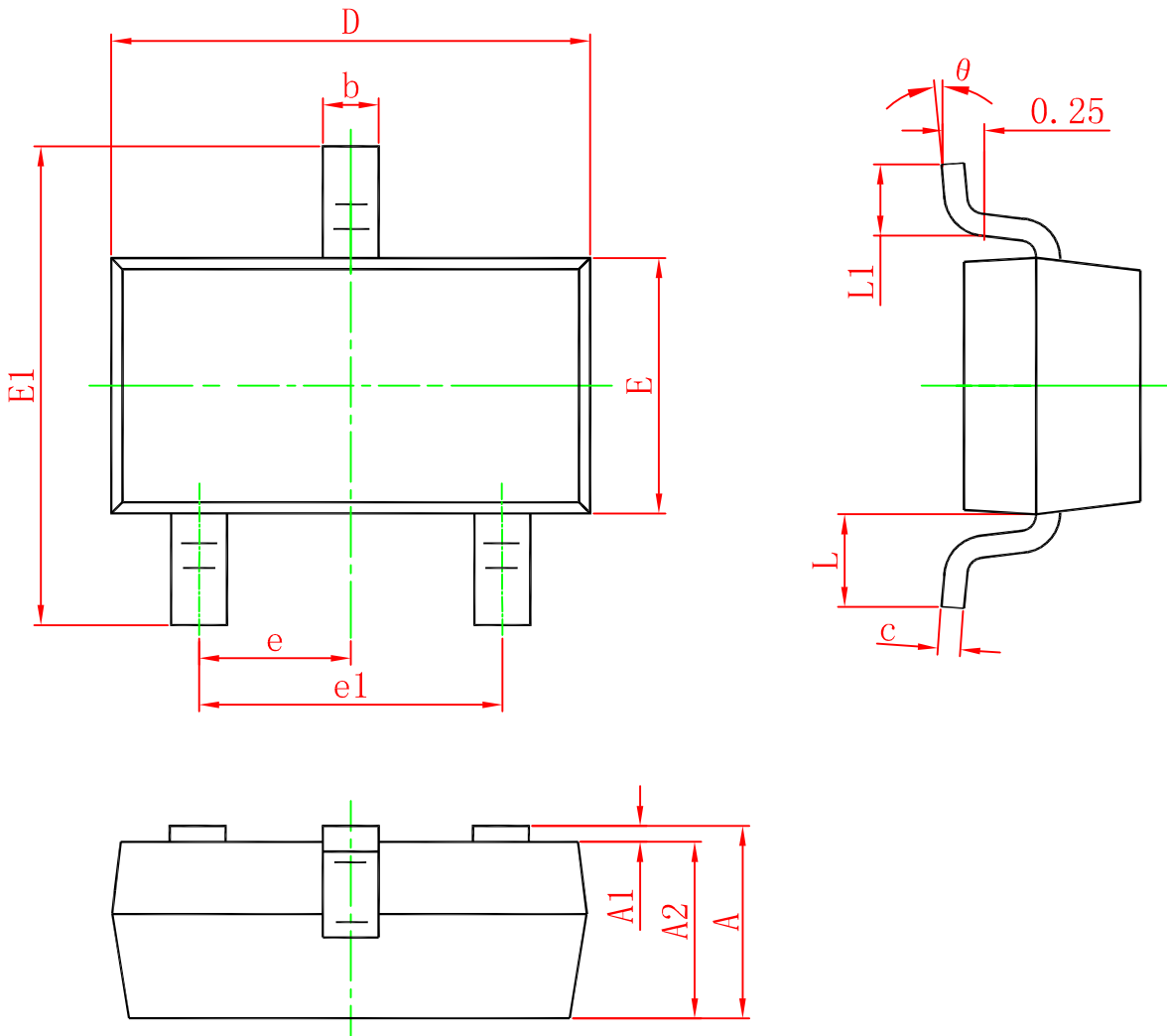
On-Resistance vs. Gate-to-Source voltage

On-Resistance vs. Junction temperature

Threshold voltage vs. Temperature

Capacitance

Body diode forward voltage

Single pulse power

Safe operating power

Gate charge Characteristics



Transient thermal response (Junction-to-Ambient)

Package outline dimensions
SOT-23

Symbol	Dimensions In Millimeters	
	Min.	Max.
A	0.900	1.150
A1	0.000	0.100
A2	0.900	1.050
b	0.300	0.500
c	0.080	0.150
D	2.800	3.000
E	1.200	1.400
E1	2.250	2.550
e	0.950 (Typ.)	
e1	1.800	2.000
L	0.550 (Typ.)	
L1	0.300	0.500
θ	0°	8°