

# WNM07N60/WNM07N60F

## 600V N-Channel MOSFET

### Description

The WNM07N60/WNM07N60F is N-Channel enhancement MOS Field Effect Transistor. Uses advanced high voltage MOSFET Process and design to provide excellent  $R_{DS(ON)}$  with low gate charge. This device is suitable for use in popular AC-DC applications, power switching application and a wide variety of other applications.

### Features

- 600V@ $T_J=25^\circ\text{C}$
- Typ. $R_{DS(on)}=1.0$
- Low gate charge
- 100% avalanche tested
- 100%  $R_g$  tested

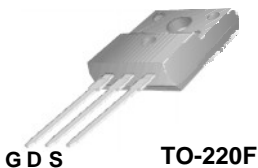
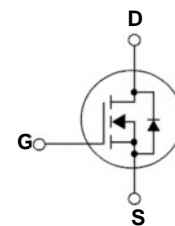
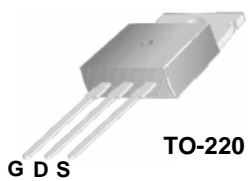

WNM07N60 =Devices code

WNM07N60F =Devices code

Y Y =Year  
WW =Week

Y Y =Year  
WW =Week

### Order Information

Device	Package	Units/Tube
WNM07N60_3/T	TO-220	50
WNM07N60F_3/T	TO-220-F	50

Absolusion Maximum Ratings $T_A=25^\circ\text{C}$ unless otherwise noted					
Parameter	Symbol	WNM07N60	WNM07N60F	Unit	
Drain-Source Voltage	$V_{DS}$	600	600	V	
Gate-Source Voltage	$V_{GS}$	$\pm 30$	$\pm 30$		
Continuous Drain Current	$I_D$	$T_C=25^\circ\text{C}$	7	7*	A
		$T_C=100^\circ\text{C}$	4.8	4.8*	
Pulsed Drain Current	$I_{DM}$	28		A	
Single Pulsed Avalanche Energy <sup>C</sup>	$E_{AS}$	124		mJ	
Peak diode recovery dv/dt	dv/dt	5		V/ns	
Power Dissipation <sup>B</sup>	$P_D$	$T_C=25^\circ\text{C}$	156	34	W
		Derate above 25°C	1.24	0.27	W/°C
Operating and Storage Temperature Range	$T_J, T_{STG}$	-55~150		°C	
Lead Temperature	$T_L$	260		°C	
Thermal Resistance Ratings					
Maximum Junction-to-Ambient <sup>A</sup>	$R_{JA}$	65	65	°C/W	
Maximum Case to Sink	$R_{CS}$	0.5			
Maximum Junction-to-Case	$R_{JC}$	0.8	3.6		

\*Drain current limited by maximum junction temperature.

**Electronics Characteristics (T<sub>A</sub>=25°C, unless otherwise noted)**

Parameter	Symbol	Test Conditions	Min	Typ	Max	Unit
<b>OFF CHARACTERISTICS</b>						
Drain-to-Source Breakdown Voltage	BV <sub>DSS</sub>	V <sub>GS</sub> = 0 V, I <sub>D</sub> = 250uA	600			V
Breakdown Voltage Temperature Coefficient	$\frac{\Delta BV_{DSS}}{\Delta T_J}$	I <sub>D</sub> = 250uA, Referenced to 25°C		0.72		V/ <sup>0</sup> C
Zero Gate Voltage Drain Current	I <sub>DSS</sub>	V <sub>DS</sub> = 600V, V <sub>GS</sub> = 0V			1	uA
Gate-to-source Leakage Current	I <sub>GSS</sub>	V <sub>DS</sub> = 0 V, V <sub>GS</sub> = ± 30 V			± 100	nA
<b>ON CHARACTERISTICS</b>						
Gate Threshold Voltage	V <sub>GS(TH)</sub>	V <sub>GS</sub> = V <sub>DS</sub> , I <sub>D</sub> = 250uA	3.0	4.0	5.0	V
Drain-to-source On-resistance <sup>D</sup>	R <sub>DS(on)</sub>	V <sub>GS</sub> = 10V, I <sub>D</sub> = 3.5A		1.0	1.2	
<b>DYNAMIC PARAMETERS</b>						
Input Capacitance	C <sub>ISS</sub>	V <sub>GS</sub> = 0 V, f = 1.0 MHz, V <sub>DS</sub> = 25 V		930		pF
Output Capacitance	C <sub>OSS</sub>			93		
Reverse Transfer Capacitance	C <sub>RSS</sub>			7.8		
Total Gate Charge	Q <sub>G(TOT)</sub>	V <sub>GS</sub> = 10 V, V <sub>DS</sub> = 480 V, I <sub>D</sub> = 3.5A		17.8		nC
Threshold Gate Charge	Q <sub>G(TH)</sub>			3.55		
Gate-to-Source Charge	Q <sub>GS</sub>			5.2		
Gate-to-Drain Charge	Q <sub>GD</sub>			7.1		
Gate resistance	R <sub>g</sub>	V <sub>GS</sub> =0V, V <sub>DS</sub> =0V, F=1MHZ		4.8		
<b>SWITCHING CHARACTERISTICS</b>						
Turn-On Delay Time	t <sub>d(on)</sub>	V <sub>GS</sub> = 10V, V <sub>DS</sub> = 300 V, I <sub>D</sub> = 7.0 A, R <sub>G</sub> =25		27.7		ns
Rise Time	t <sub>r</sub>			42.7		
Turn-Off Delay Time	t <sub>d(off)</sub>			48.53		
Fall Time	t <sub>f</sub>			34.13		
<b>Drain to Source Diode Characteristics and Maximum Ratings</b>						
Forward Voltage	V <sub>SD</sub>	V <sub>GS</sub> = 0 V, I <sub>S</sub> = 1.0A		0.74	1.5	V
Maximum Body-Diode Continuous Current	I <sub>S</sub>				7	A
Maximum Body-Diode Pulsed Current	I <sub>SM</sub>				28	A
Body Diode Reverse Recovery Time	T <sub>rr</sub>	I <sub>F</sub> =7A, di/dt=100A/us, V <sub>DS</sub> =100V		370		nS
Body Diode Reverse Recovery Charge	Q <sub>rr</sub>	I <sub>F</sub> =7A, di/dt=100A/us, V <sub>DS</sub> =100V		2.35		uC

**NOTES:**

- The value of R<sub>JA</sub> is measured with the device in a still air environment with T<sub>A</sub> =25°C.
- The power dissipation P<sub>D</sub> is based on T<sub>J(MAX)</sub> =150°C, using junction-to-case thermal resistance.
- L=8.2mH, I<sub>AS</sub>=5.5A, V<sub>DD</sub>=50V, R<sub>G</sub>=25 , Starting T<sub>J</sub>=25°C.
- Pulse width 380s, Duty Cycle 2%.

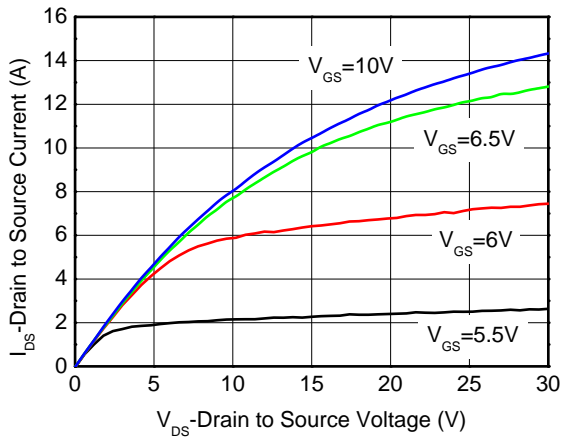
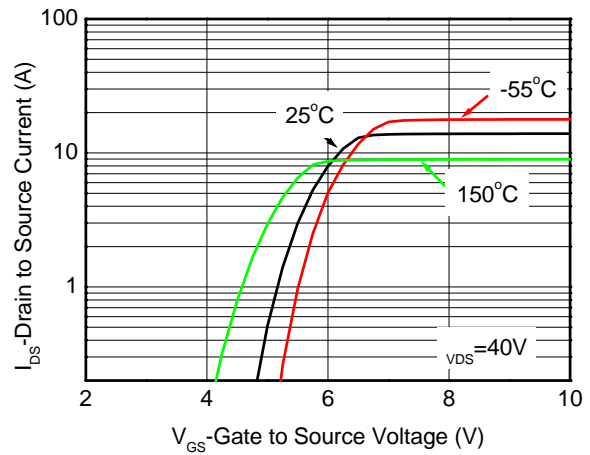
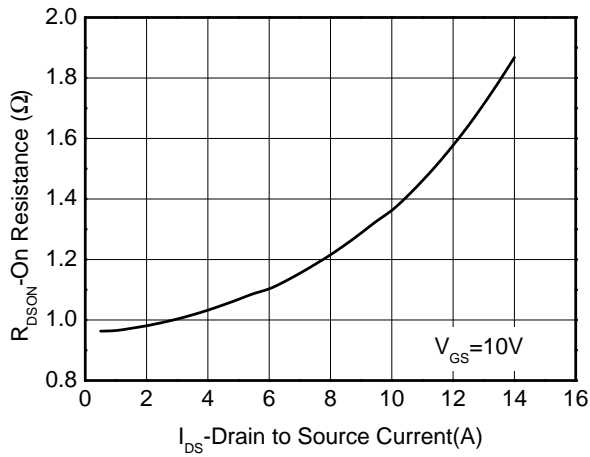
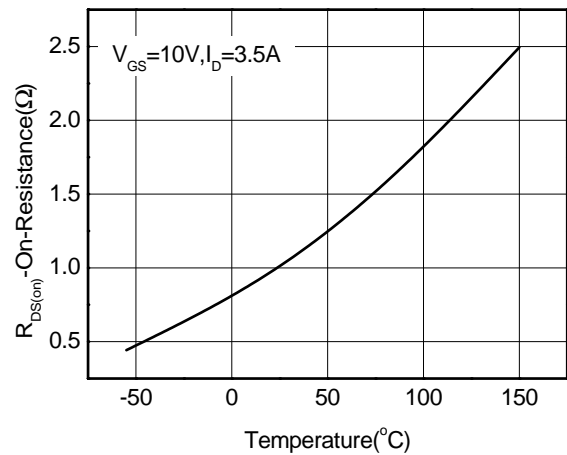
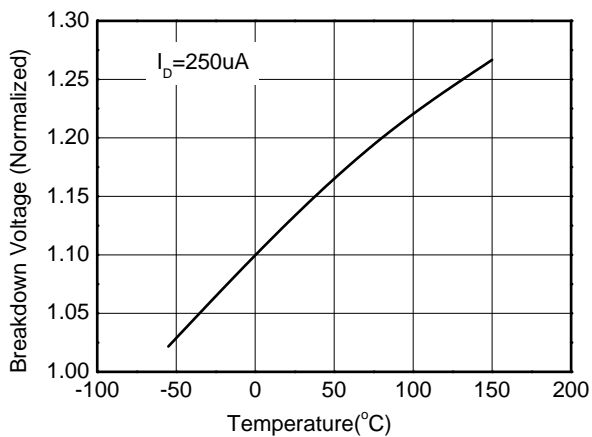
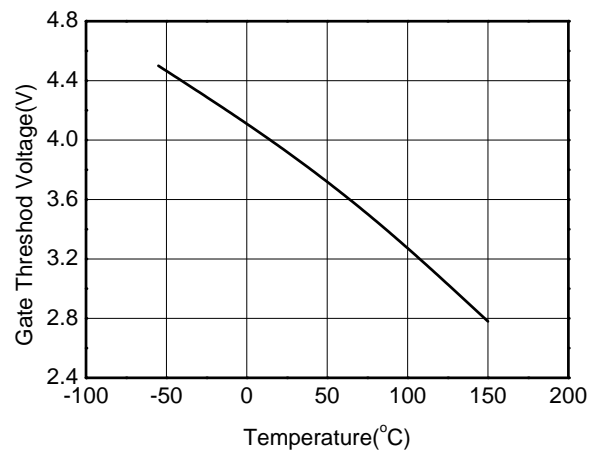
**Typical Characteristics ( $T_A=25^\circ\text{C}$ , unless otherwise noted)**

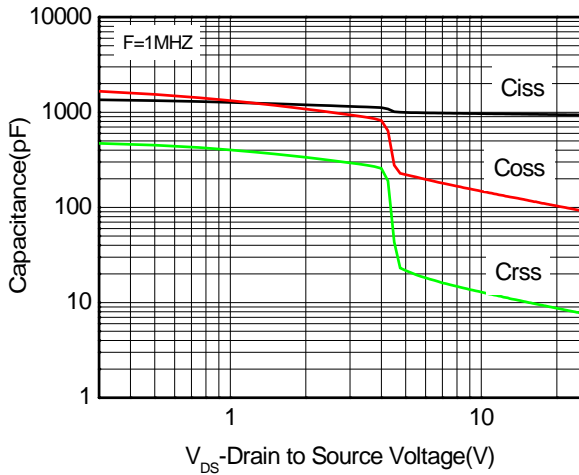
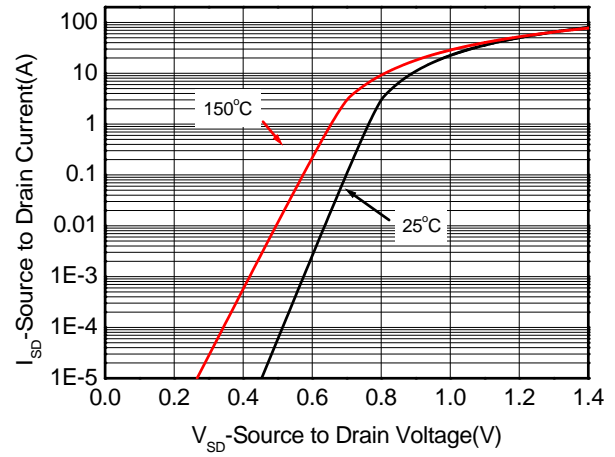
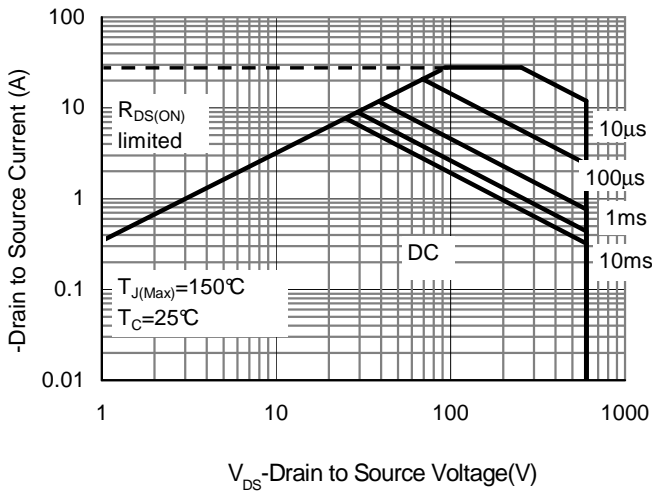
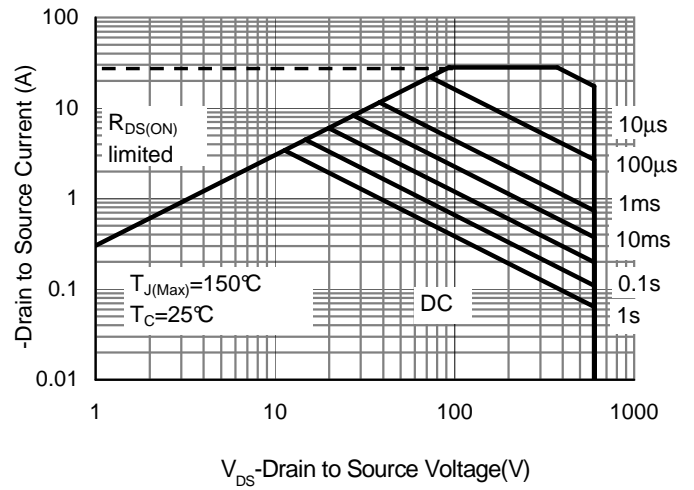
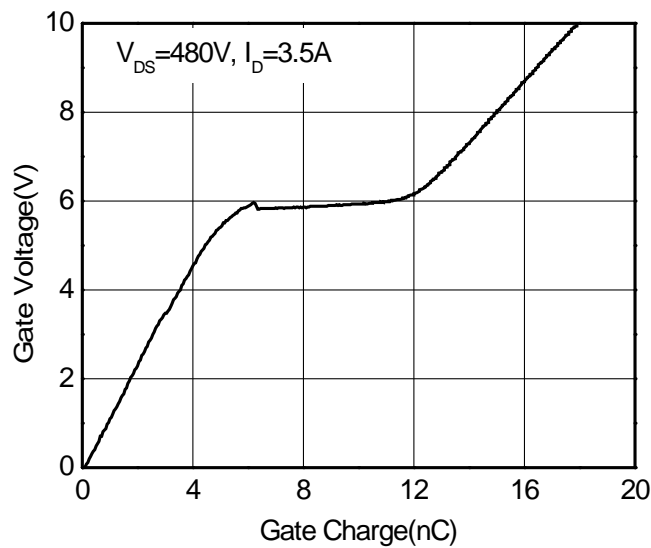
**Output characteristics**

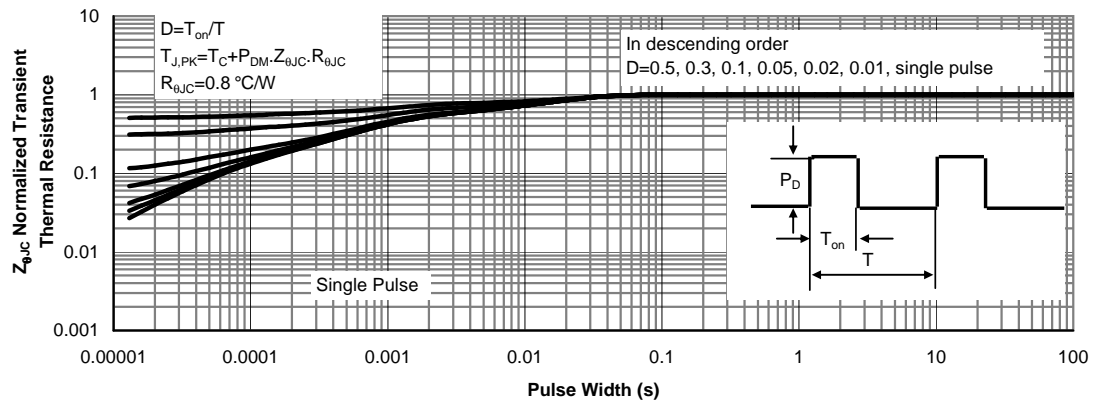
**Transfer characteristics**

**On-Resistance vs. Drain current**

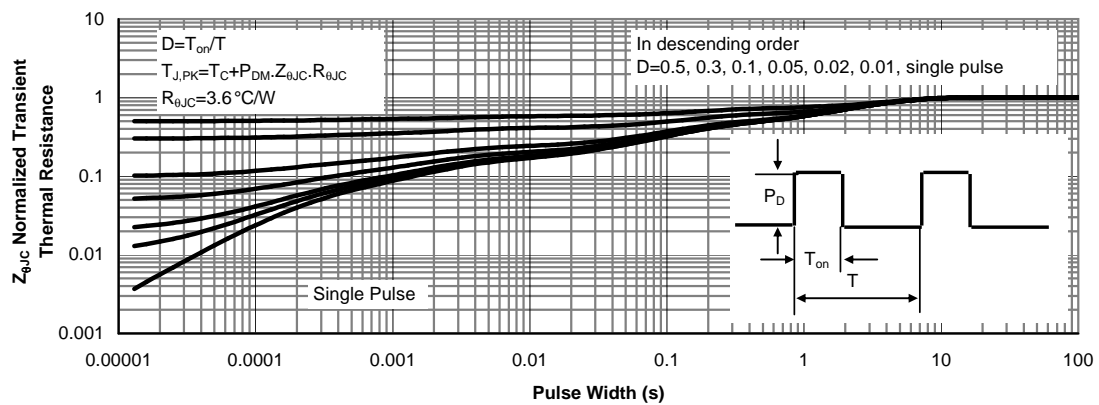
**On-Resistance vs. Junction temperature**

**Breakdown Voltage vs. Junction temperature**

**Threshold voltage vs. Temperature**



**Capacitance**

**Body diode forward voltage**

**Safe Operating Power (WNM07N60F)**

**Safe Operating Power (WNM07N60)**

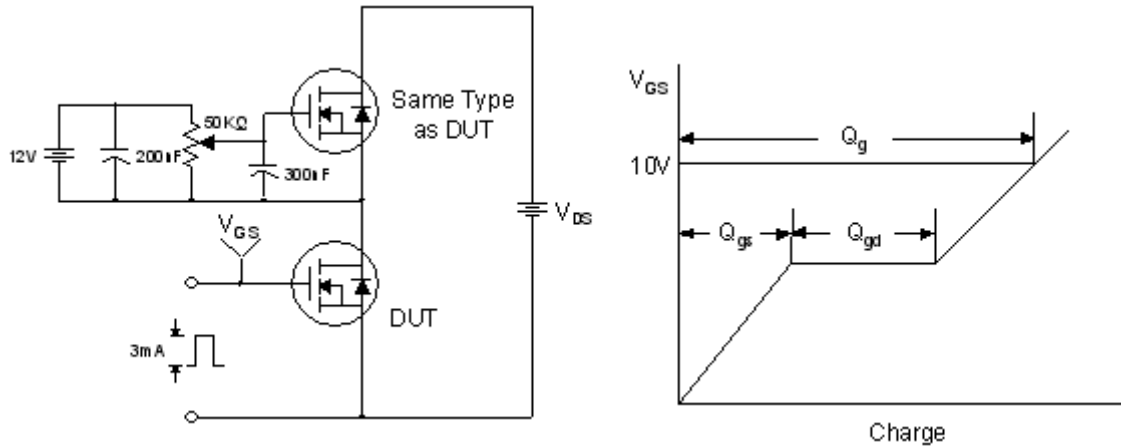
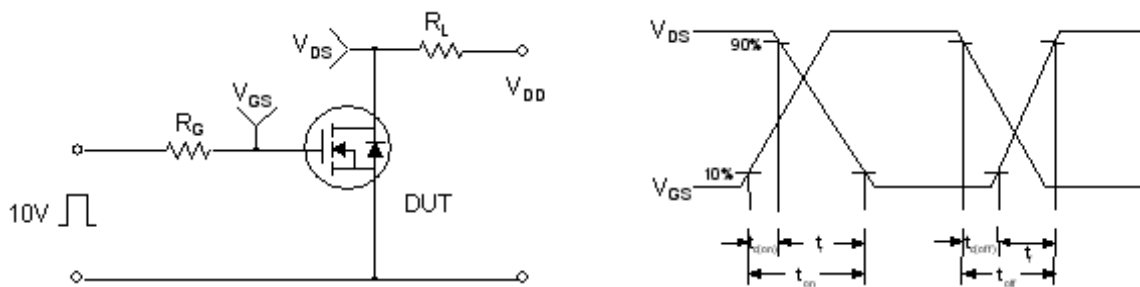
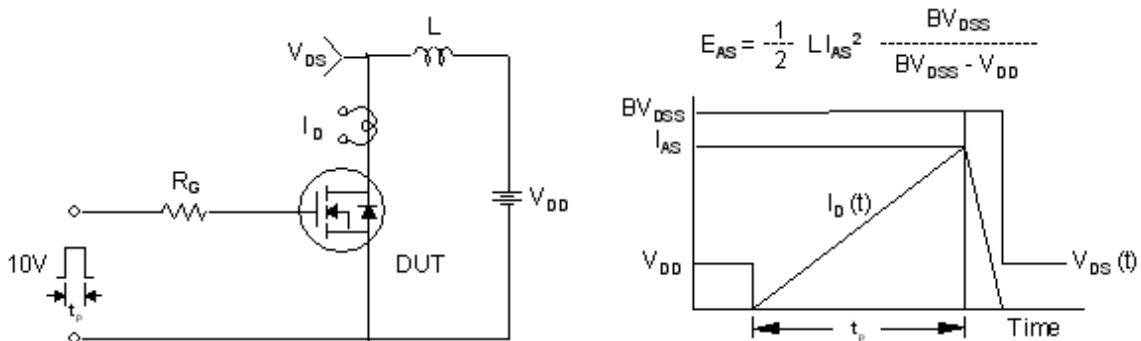
**Gate charge Characteristics**



**Transient thermal response (Junction-to-Case WNM07N60)**



**Transient thermal response (Junction-to-Case WNM07N60F)**

**Gate Charge Test Circuit & Waveform**

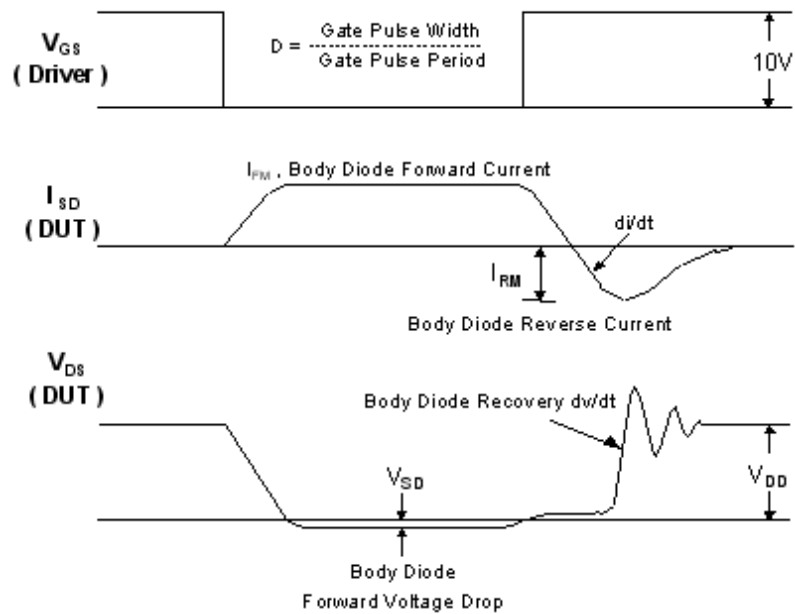
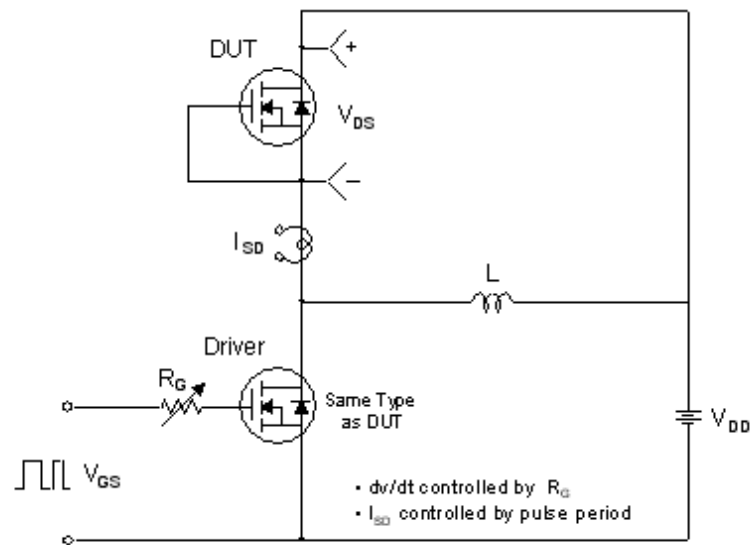
**Resistive Switching Test Circuit & Waveforms**

**Unclamped Inductive Switching Test Circuit & Waveforms**

**Peak Diode Recovery dv/dt Test Circuit & Waveforms**

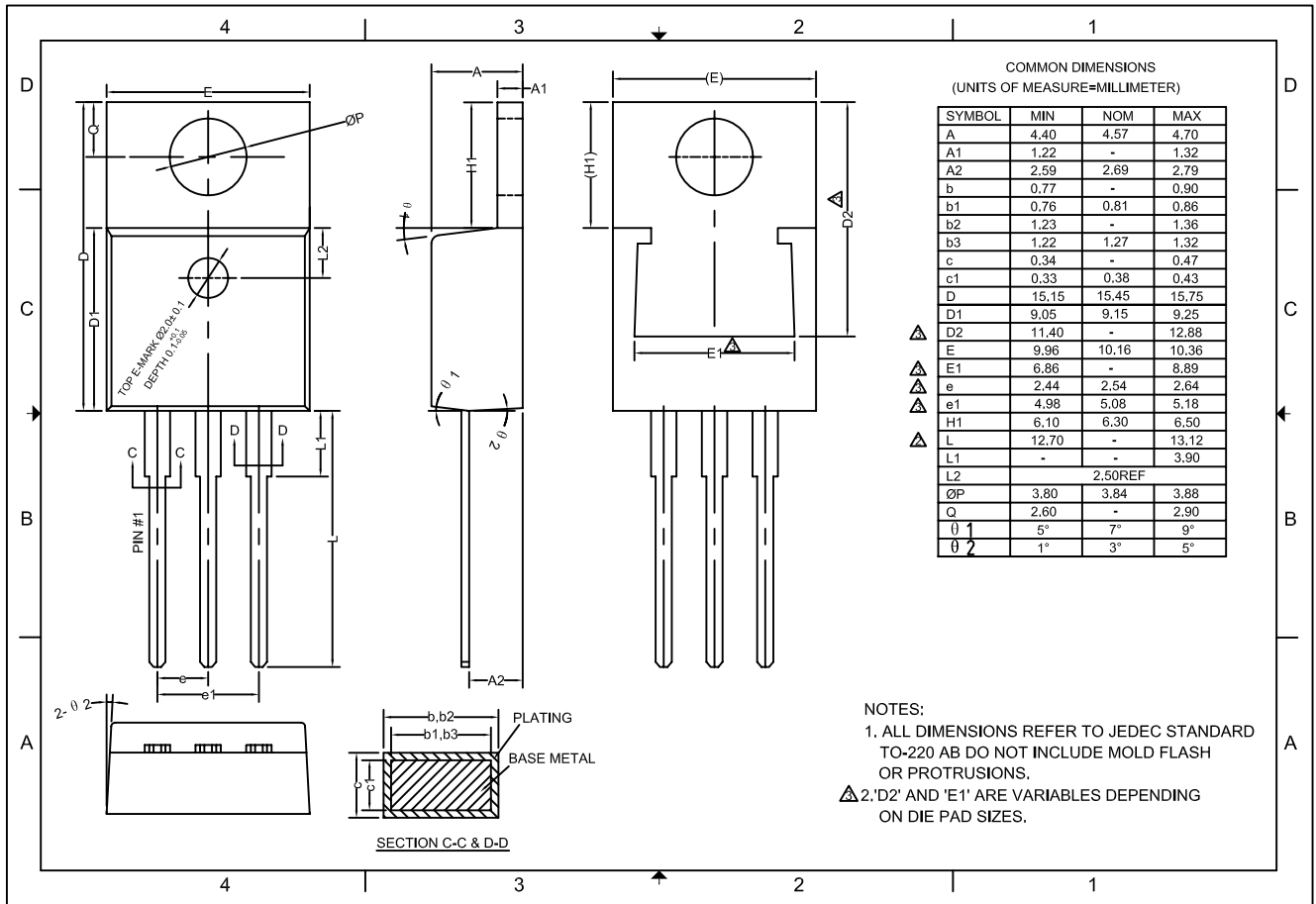
# Package outline dimensions

## TO-220



## TO-220F

