

WNM07N65/WNM07N65F

650V N-Channel MOSFET

Description

The WNM07N65/WNM07N65F is N-Channel enhancement MOS Field Effect Transistor. Uses advanced high voltage MOSFET Process and design to provide excellent $R_{DS(ON)}$ with low gate charge. This device is suitable for use in popular AC-DC applications, power switching application and a wide variety of other applications.

Features

- 650V@ $T_J=25^\circ\text{C}$
- Typ. $R_{DS(on)}=1.0$
- Low gate charge
- 100% avalanche tested
- 100% R_g tested

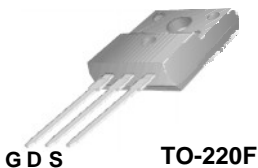
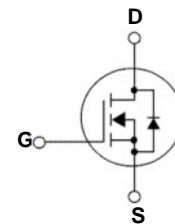
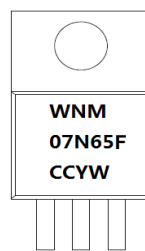
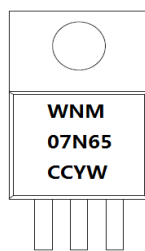
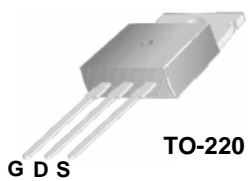

WNM07N65 =Devices code
 CC = Special Code
 Y =Year
 W =Week

WNM07N65F =Devices code
 CC = Special Code
 Y =Year
 W =Week

Order Information

Device	Package	Units/Tube
WNM07N65_3/T	TO-220	50
WNM07N65F_3/T	TO-220-F	50

Absolusion Maximum Ratings $T_A=25^\circ\text{C}$ unless otherwise noted					
Parameter	Symbol	WNM07N65	WNM07N65F	Unit	
Drain-Source Voltage	V_{DS}	650	650	V	
Gate-Source Voltage	V_{GS}	± 30	± 30		
Continuous Drain Current	I_D	$T_C=25^\circ\text{C}$	7	7*	A
		$T_C=100^\circ\text{C}$	4.8	4.8*	
Pulsed Drain Current	I_{DM}	28		A	
Single Pulsed Avalanche Energy ^C	E_{AS}	124		mJ	
Peak diode recovery dv/dt	dv/dt	5		V/ns	
Power Dissipation ^B	P_D	$T_C=25^\circ\text{C}$	156	34	W
		Derate above 25°C	1.24	0.27	W/ $^\circ\text{C}$
Operating and Storage Temperature Range	T_J, T_{STG}	-55~150		$^\circ\text{C}$	
Lead Temperature	T_L	260		$^\circ\text{C}$	
Thermal Resistance Ratings					
Maximum Junction-to-Ambient ^A	R_{JA}	65	65	$^\circ\text{C}/\text{W}$	
Maximum Case to Sink	R_{CS}	0.5			
Maximum Junction-to-Case	R_{JC}	0.8	3.6		

*Drain current limited by maximum junction temperature.

Electronics Characteristics (T_A=25°C, unless otherwise noted)

Parameter	Symbol	Test Conditions	Min	Typ	Max	Unit
OFF CHARACTERISTICS						
Drain-to-Source Breakdown Voltage	BV _{DSS}	V _{GS} = 0 V, I _D = 250μA	650			V
Breakdown Voltage Temperature Coefficient	$\frac{\Delta B_{V_{DSS}}}{\Delta T_J}$	I _D = 250μA, Referenced to 25°C		0.72		V/°C
Zero Gate Voltage Drain Current	I _{DSS}	V _{DS} = 600V, V _{GS} = 0V			1	μA
Gate-to-source Leakage Current	I _{GSS}	V _{DS} = 0 V, V _{GS} = ±30 V			±100	nA
ON CHARACTERISTICS						
Gate Threshold Voltage	V _{GS(TH)}	V _{GS} = V _{DS} , I _D = 250μA	3.0	4.0	5.0	V
Drain-to-source On-resistance ^D	R _{DS(on)}	V _{GS} = 10V, I _D = 3.5A		1.0	1.2	
DYNAMIC PARAMETERS						
Input Capacitance	C _{ISS}	V _{GS} = 0 V,		930		pF
Output Capacitance	C _{OSS}	f = 1.0 MHz,		93		
Reverse Transfer Capacitance	C _{RSS}	V _{DS} = 25 V		7.8		
Total Gate Charge	Q _{G(TOT)}	V _{GS} = 10 V, V _{DS} = 480 V, I _D = 3.5A		17.8		nC
Threshold Gate Charge	Q _{G(TH)}			3.55		
Gate-to-Source Charge	Q _{GS}			5.2		
Gate-to-Drain Charge	Q _{GD}			7.1		
Gate resistance	R _g	V _{GS} =0V, V _{DS} =0V, F=1MHZ		4.8		
SWITCHING CHARACTERISTICS						
Turn-On Delay Time	t _{d(on)}	V _{GS} = 10V,		27.7		ns
Rise Time	t _r	V _{DS} = 300 V,		42.7		
Turn-Off Delay Time	t _{d(off)}	I _D = 7.0 A,		48.53		
Fall Time	t _f	R _G =25		34.13		
Drain to Source Diode Characteristics and Maximum Ratings						
Forward Voltage	V _{SD}	V _{GS} = 0 V, I _S = 1.0A		0.74	1.5	V
Maximum Body-Diode Continuous Current	I _S				7	A
Maximum Body-Diode Pulsed Current	I _{SM}				28	A
Body Diode Reverse Recovery Time	T _{rr}	I _F =7A, dI/dt=100A/us, V _{DS} =100V		370		nS
Body Diode Reverse Recovery Charge	Q _{rr}	I _F =7A, dI/dt=100A/us, V _{DS} =100V		2.35		μC

NOTES:

- The value of R_{JA} is measured with the device in a still air environment with T_A =25°C.
- The power dissipation P_D is based on T_{J(MAX)} =150°C, using junction-to-case thermal resistance.
- L=8.2mH, I_{AS}=5.5A, V_{DD}=50V, R_G=25 , Starting T_J=25°C.
- Pulse width 380s, Duty Cycle 2%.

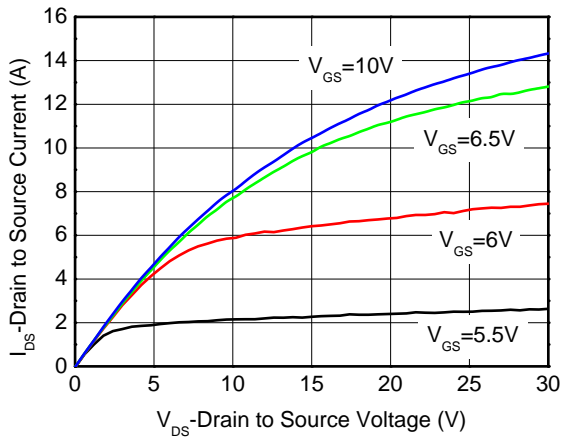
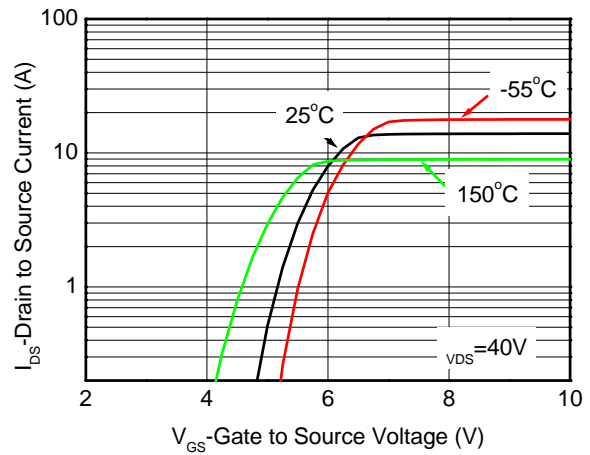
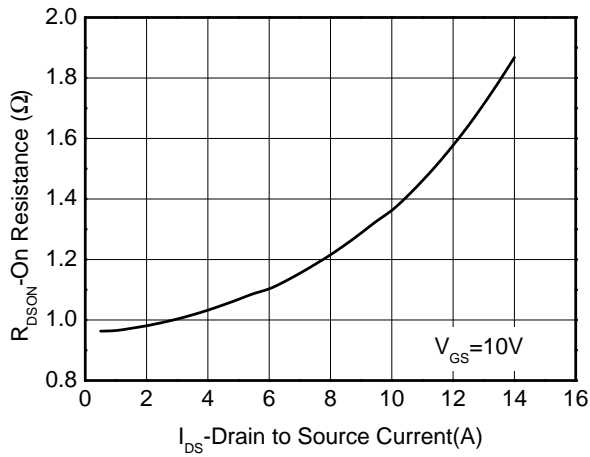
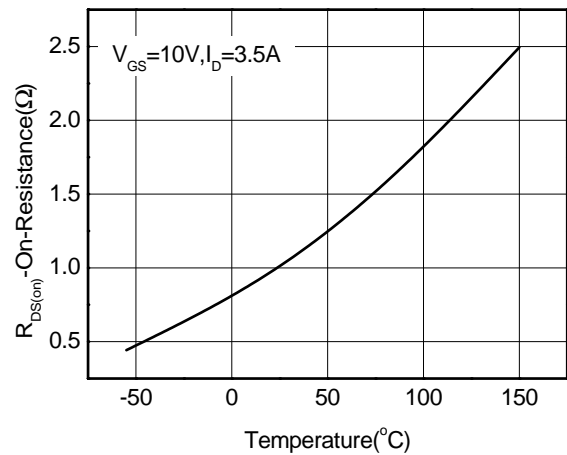
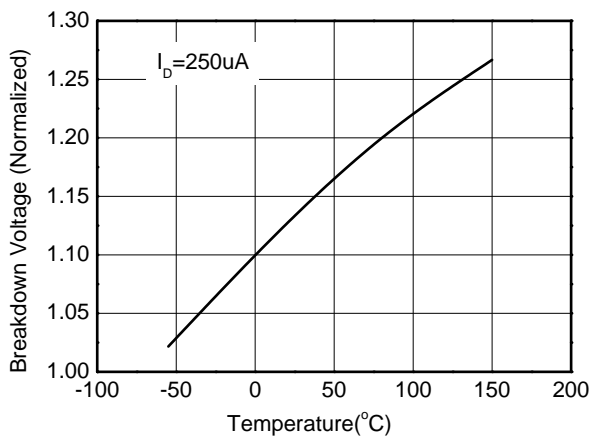
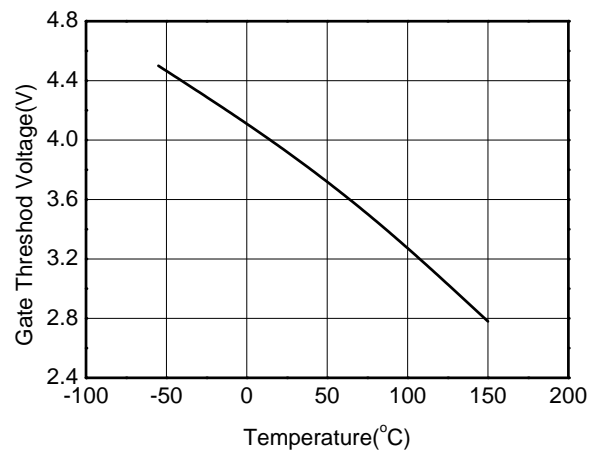
Typical Characteristics ($T_A=25^\circ\text{C}$, unless otherwise noted)

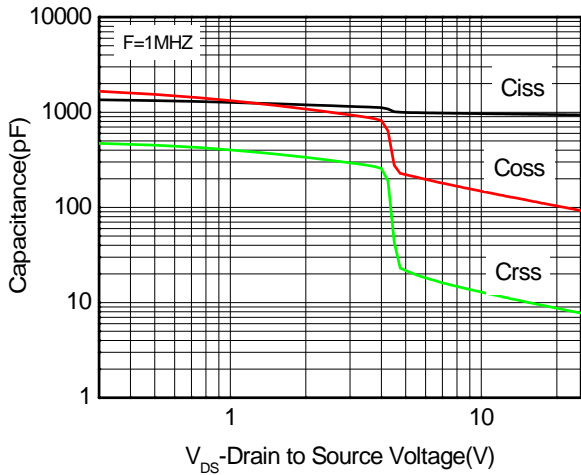
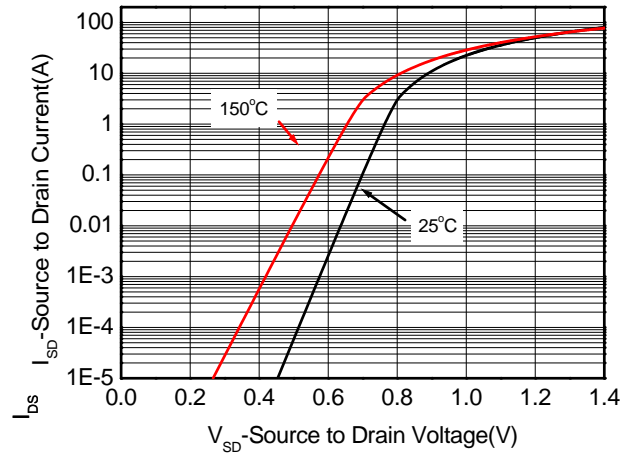
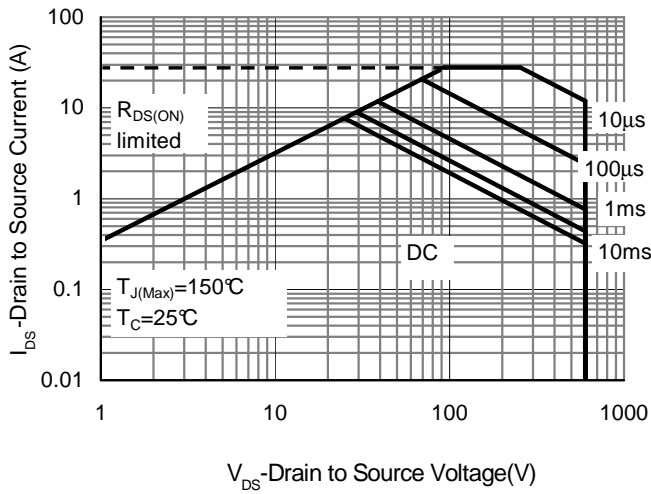
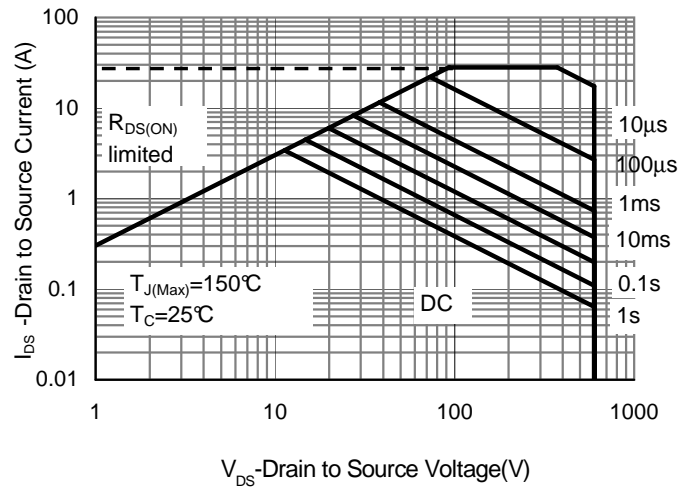
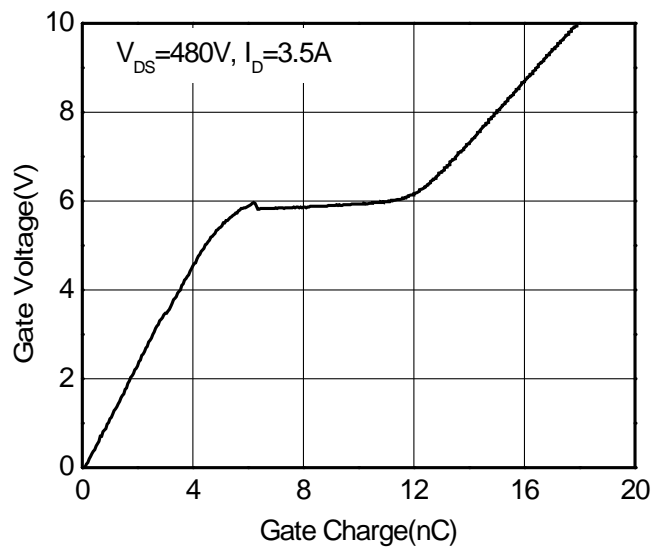
Output characteristics

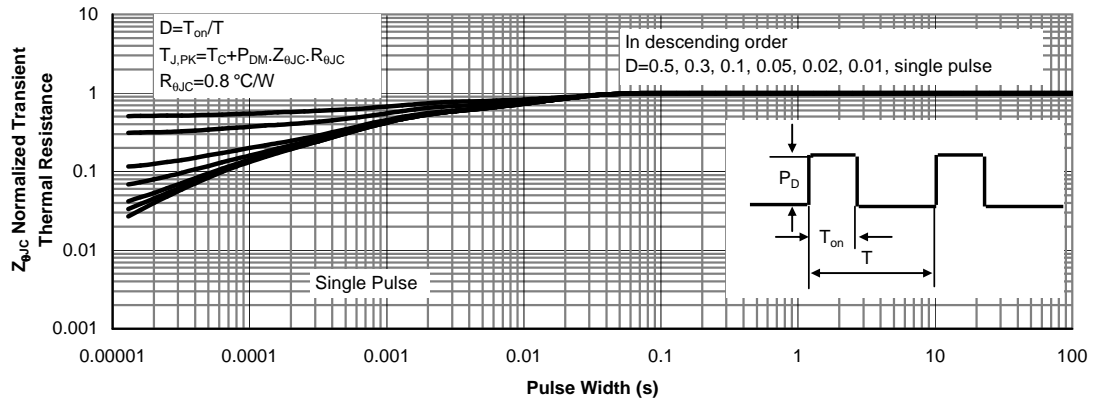
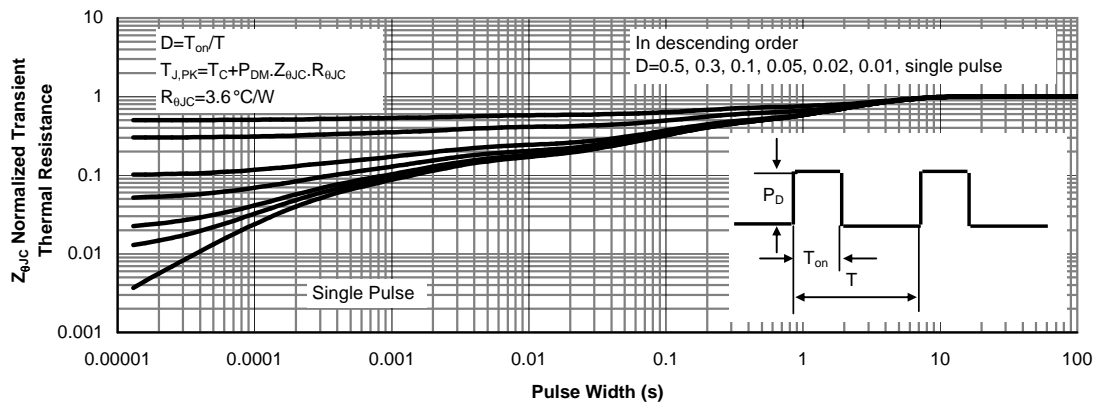
Transfer characteristics

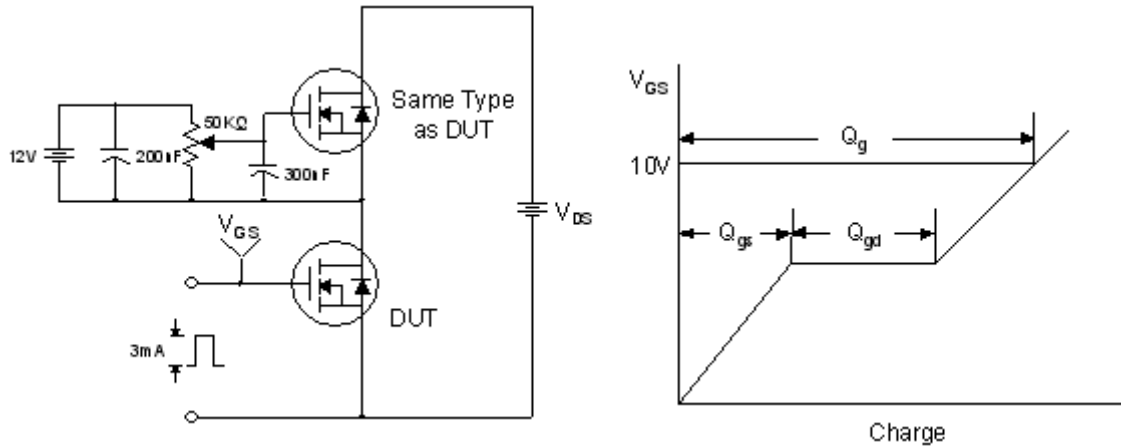
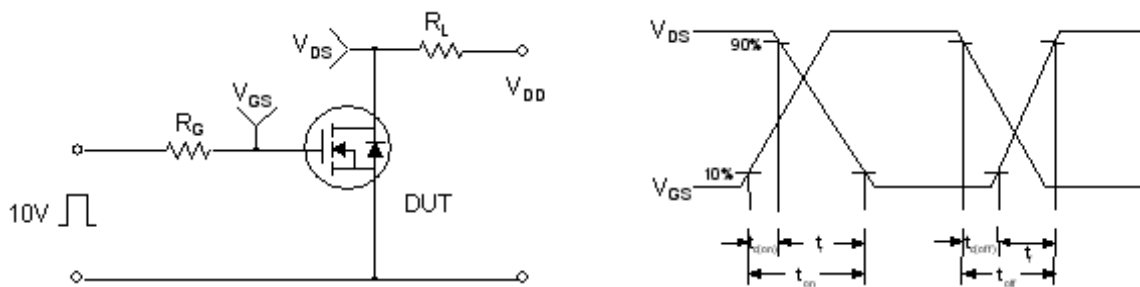
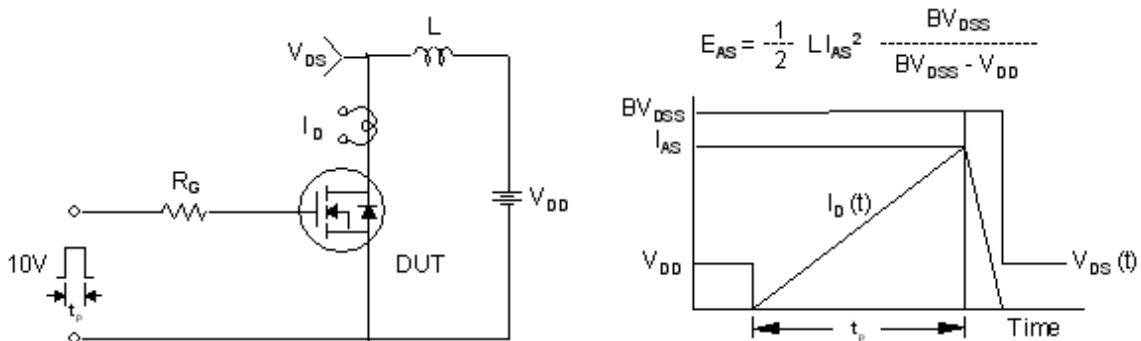
On-Resistance vs. Drain current

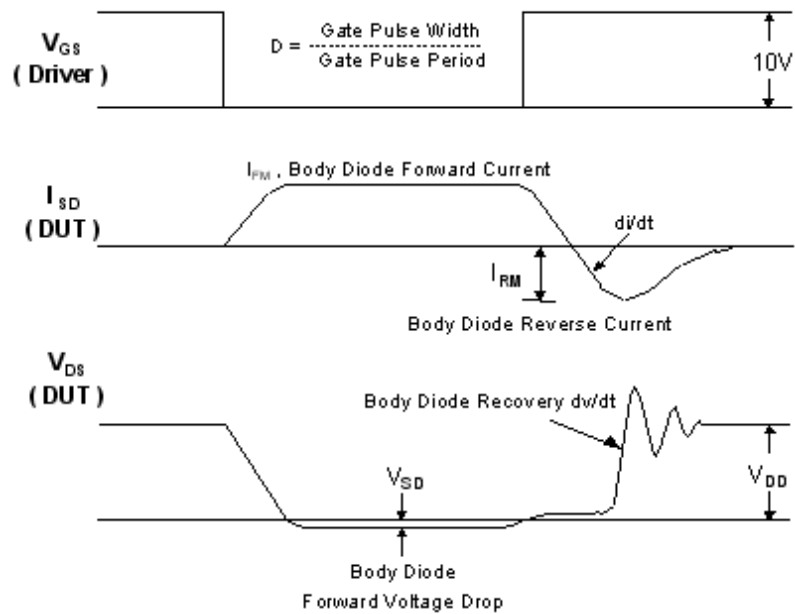
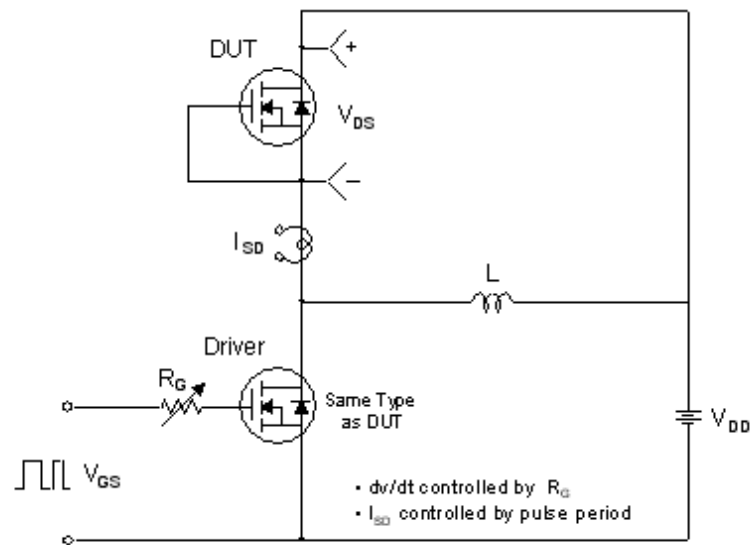
On-Resistance vs. Junction temperature

Breakdown Voltage vs. Junction temperature

Threshold voltage vs. Temperature

Capacitance

Body diode forward voltage

Safe Operating Power (WNM07N65F)

Safe Operating Power (WNM07N65)

Gate charge Characteristics



Transient thermal response (Junction-to-Case WNM07N65F)

Transient thermal response (Junction-to-Case WNM07N65)

Gate Charge Test Circuit & Waveform

Resistive Switching Test Circuit & Waveforms

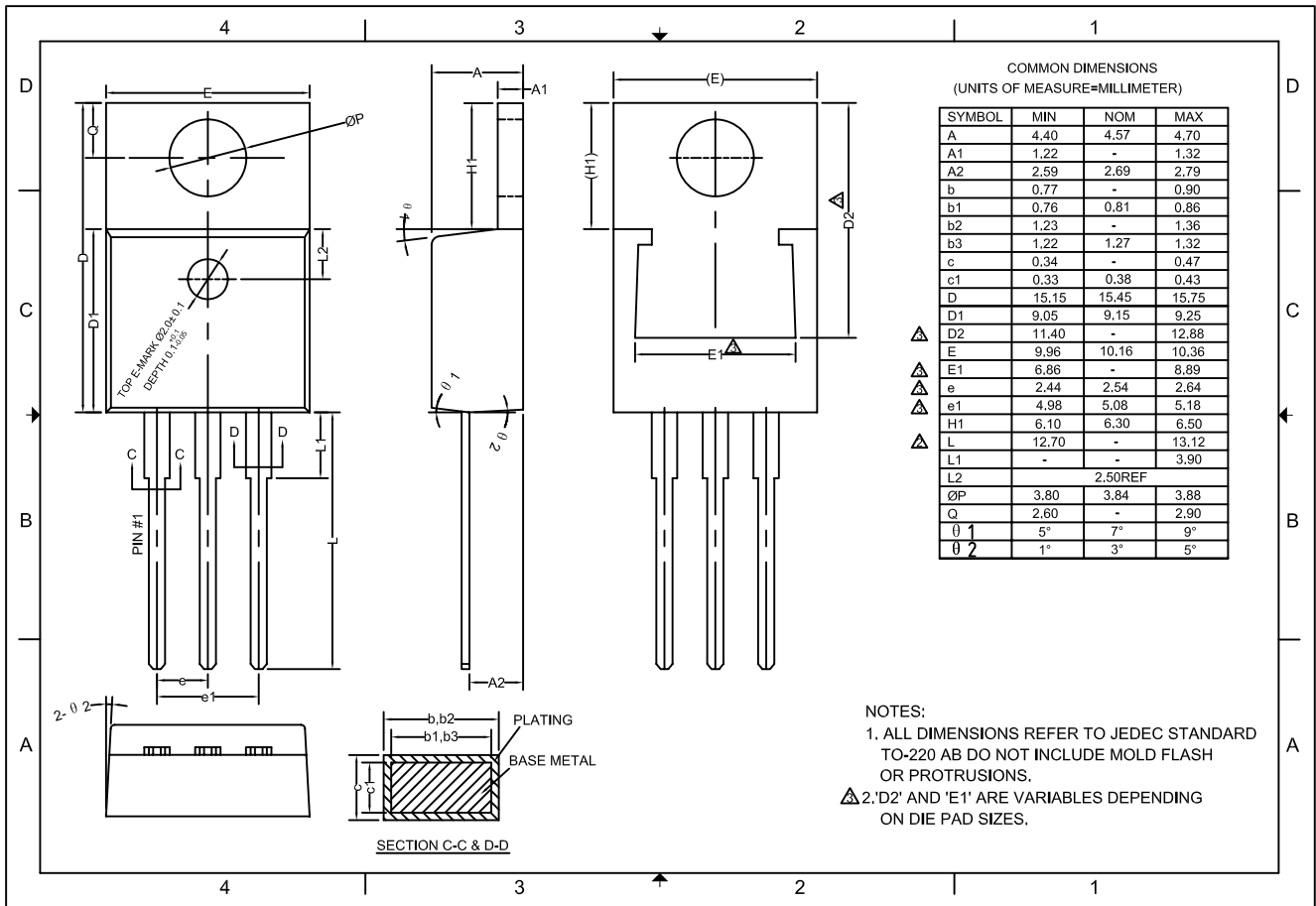
Unclamped Inductive Switching Test Circuit & Waveforms

Peak Diode Recovery dv/dt Test Circuit & Waveforms

Package outline dimensions

TO-220



TO-220F

