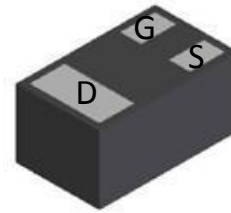
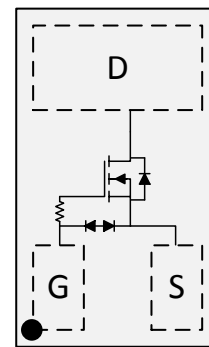

**WNM2046**
**Single N-Channel, 20V, 0.71A, Power MOSFET**
[Http://www.sh-willsemi.com](http://www.sh-willsemi.com)

$V_{DS}$ (V)	Typical $R_{DS(on)}$ ( )
20	0.220@ $V_{GS}=4.5V$
	0.260@ $V_{GS}=2.5V$
	0.315@ $V_{GS}=1.8V$

**DFN1006-3L**
**Descriptions**

The WNM2046 is N-Channel enhancement MOS Field Effect Transistor. Uses advanced trench technology and design to provide excellent  $R_{DS(ON)}$  with low gate charge. This device is suitable for use in DC-DC conversion, power switch and charging circuit. Standard Product WNM2046 is Pb-free.

**Pin configuration (Top view)**
**Features**

- Trench Technology
- Supper high density cell design
- Excellent ON resistance for higher DC current
- Extremely Low Threshold Voltage
- Small package DFN1006-3L

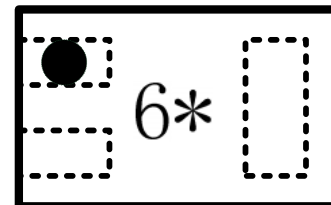

6 = Device Code  
 \* = Month (A~Z)

**Marking**
**Applications**

- Small Signal Switching
- Small Moto Driver

**Order information**

Device	Package	Shipping
WNM2046-3/TR	DFN1006-3L	10K/Reel&Tape

**Absolute Maximum ratings**

Parameter		Symbol	10 S	Steady State	Unit
Drain-Source Voltage		$V_{DS}$	20		V
Gate-Source Voltage		$V_{GS}$	$\pm 5$		
Continuous Drain Current <sup>a d</sup>	$T_A=25^\circ\text{C}$	$I_D$	0.71	0.66	A
	$T_A=70^\circ\text{C}$		0.57	0.52	
Maximum Power Dissipation <sup>a d</sup>	$T_A=25^\circ\text{C}$	$P_D$	0.32	0.27	W
	$T_A=70^\circ\text{C}$		0.20	0.17	
Continuous Drain Current <sup>b d</sup>	$T_A=25^\circ\text{C}$	$I_D$	0.67	0.62	A
	$T_A=70^\circ\text{C}$		0.54	0.50	
Maximum Power Dissipation <sup>b d</sup>	$T_A=25^\circ\text{C}$	$P_D$	0.28	0.24	W
	$T_A=70^\circ\text{C}$		0.18	0.15	
Pulsed Drain Current <sup>c</sup>		$I_{DM}$	1.4		A
Operating Junction Temperature		$T_J$	150		$^\circ\text{C}$
Lead Temperature		$T_L$	260		$^\circ\text{C}$
Storage Temperature Range		$T_{stg}$	-55 to 150		$^\circ\text{C}$

**Thermal resistance ratings**

Parameter		Symbol	Typical	Maximum	Unit
Junction-to-Ambient Thermal Resistance <sup>a</sup>	t 10 s	$R_{JA}$	350	390	$^\circ\text{C/W}$
	Steady State		395	455	
Junction-to-Ambient Thermal Resistance <sup>b</sup>	t 10 s	$R_{JA}$	397	435	
	Steady State		445	505	
Junction-to-Case Thermal Resistance		$R_{JC}$	240	280	

a Surface mounted on FR4 Board using 1 square inch pad size, 1oz copper

b Surface mounted on FR4 board using minimum pad size, 1oz copper

c Pulse width < 380 $\mu\text{s}$ , Single pulse

d Maximum junction temperature  $T_J=150^\circ\text{C}$ .

e Pulse test: Pulse width < 380 us duty cycle < 2%.

**Electronics Characteristics (Ta=25°C, unless otherwise noted)**

Parameter	Symbol	Test Conditions	Min	Typ	Max	Unit
<b>OFF CHARACTERISTICS</b>						
Drain-to-Source Breakdown Voltage	$BV_{DSS}$	$V_{GS} = 0\text{ V}, I_D = 250\mu\text{A}$	20			V
Zero Gate Voltage Drain Current	$I_{DSS}$	$V_{DS} = 16\text{ V}, V_{GS} = 0\text{ V}$			1	$\mu\text{A}$
Gate-to-source Leakage Current	$I_{GSS}$	$V_{DS} = 0\text{ V}, V_{GS} = \pm 5\text{ V}$			$\pm 5$	$\mu\text{A}$
<b>ON CHARACTERISTICS</b>						
Gate Threshold Voltage	$V_{GS(TH)}$	$V_{GS} = V_{DS}, I_D = 250\mu\text{A}$	0.45	0.58	0.85	V
Drain-to-source On-resistance <sup>e</sup>	$R_{DS(on)}$	$V_{GS} = 4.5\text{ V}, I_D = 0.55\text{ A}$		220	420	m
		$V_{GS} = 2.5\text{ V}, I_D = 0.45\text{ A}$		260	500	
		$V_{GS} = 1.8\text{ V}, I_D = 0.35\text{ A}$		315	600	
Forward Transconductance	$g_{FS}$	$V_{DS} = 5\text{ V}, I_D = 0.55\text{ A}$		2.0		S
<b>CHARGES, CAPACITANCES AND GATE RESISTANCE</b>						
Input Capacitance	$C_{ISS}$	$V_{GS} = 0\text{ V}, f = 100\text{ KHz}, V_{DS} = 10\text{ V}$		50.6		pF
Output Capacitance	$C_{OSS}$			13.2		
Reverse Transfer Capacitance	$C_{RSS}$			8.3		
Total Gate Charge	$Q_{G(TOT)}$	$V_{GS} = 4.5\text{ V}, V_{DS} = 10\text{ V}, I_D = 0.55\text{ A}$		0.87		nC
Threshold Gate Charge	$Q_{G(TH)}$			0.06		
Gate-to-Source Charge	$Q_{GS}$			0.15		
Gate-to-Drain Charge	$Q_{GD}$			0.27		
<b>SWITCHING CHARACTERISTICS</b>						
Turn-On Delay Time	$t_d(ON)$	$V_{GS} = 4.5\text{ V}, V_{DS} = 10\text{ V}, I_D = 0.55\text{ A}, R_G = 6$		34		ns
Rise Time	$t_r$			97.6		
Turn-Off Delay Time	$t_d(OFF)$			606		
Fall Time	$t_f$			318		
<b>BODY DIODE CHARACTERISTICS</b>						
Forward Voltage	$V_{SD}$	$V_{GS} = 0\text{ V}, I_S = 0.35\text{ A}$	0.5	0.7	1.1	V

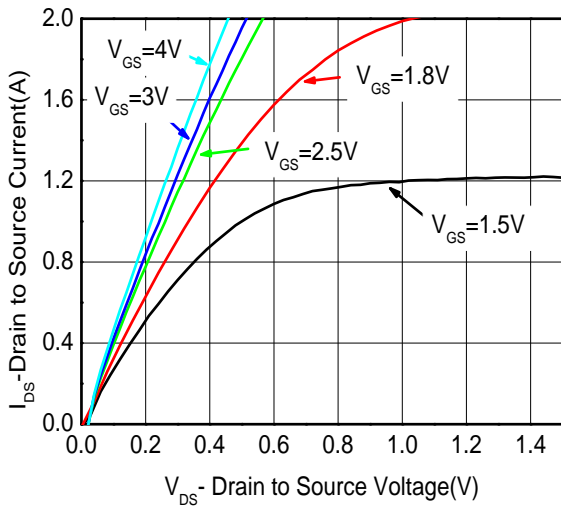
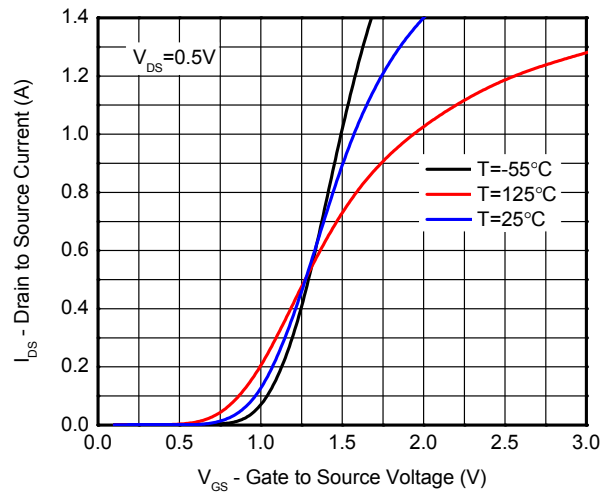
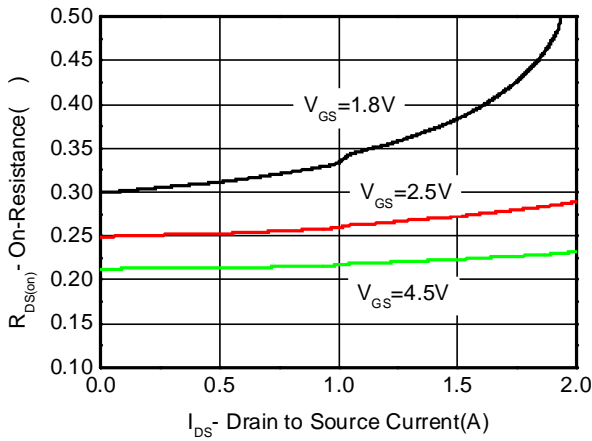
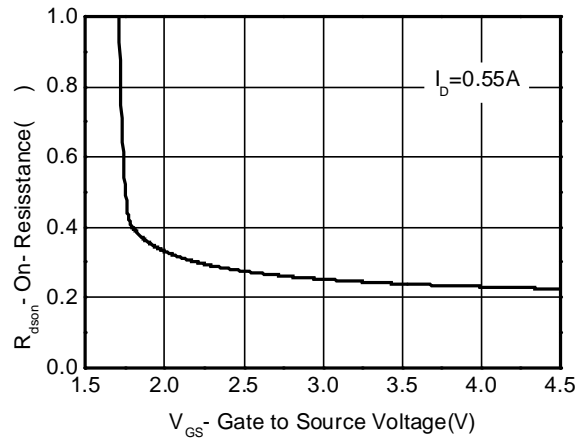
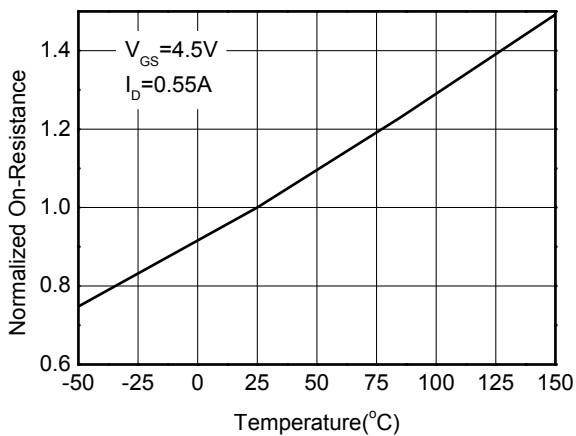
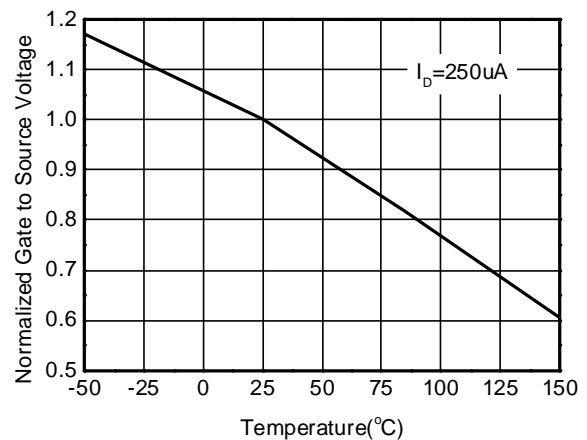
**Typical Characteristics (Ta=25°C, unless otherwise noted)**

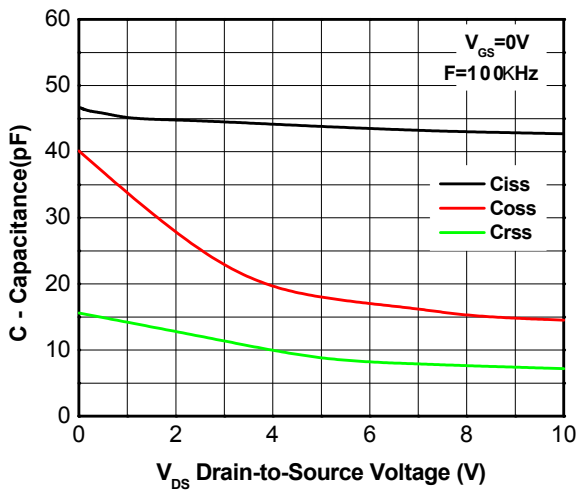
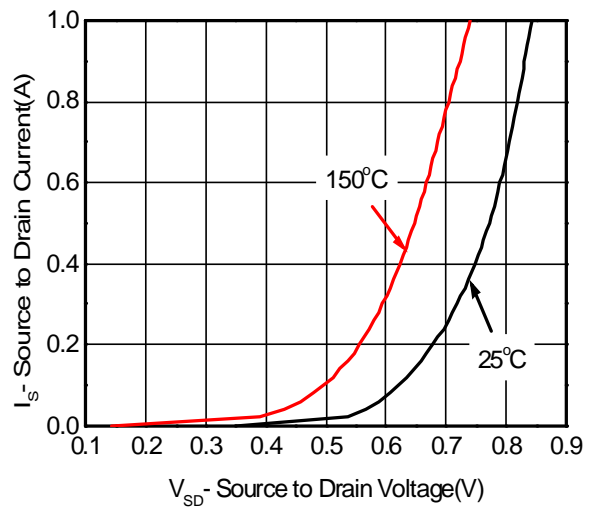
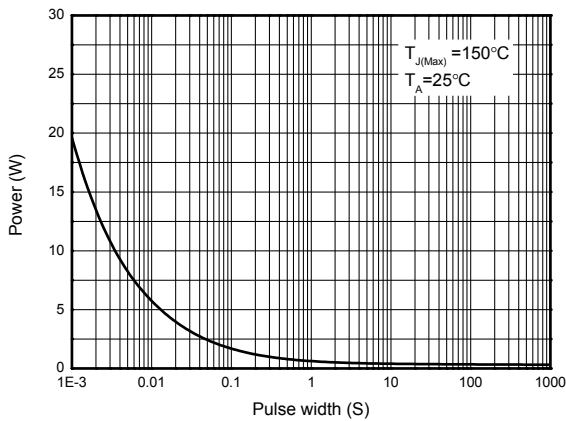
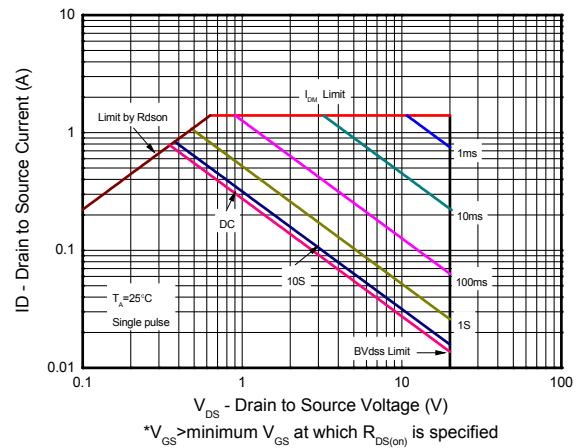
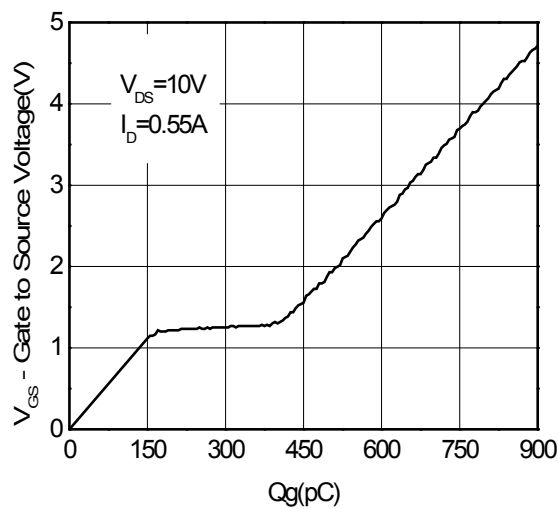
**Output characteristics**

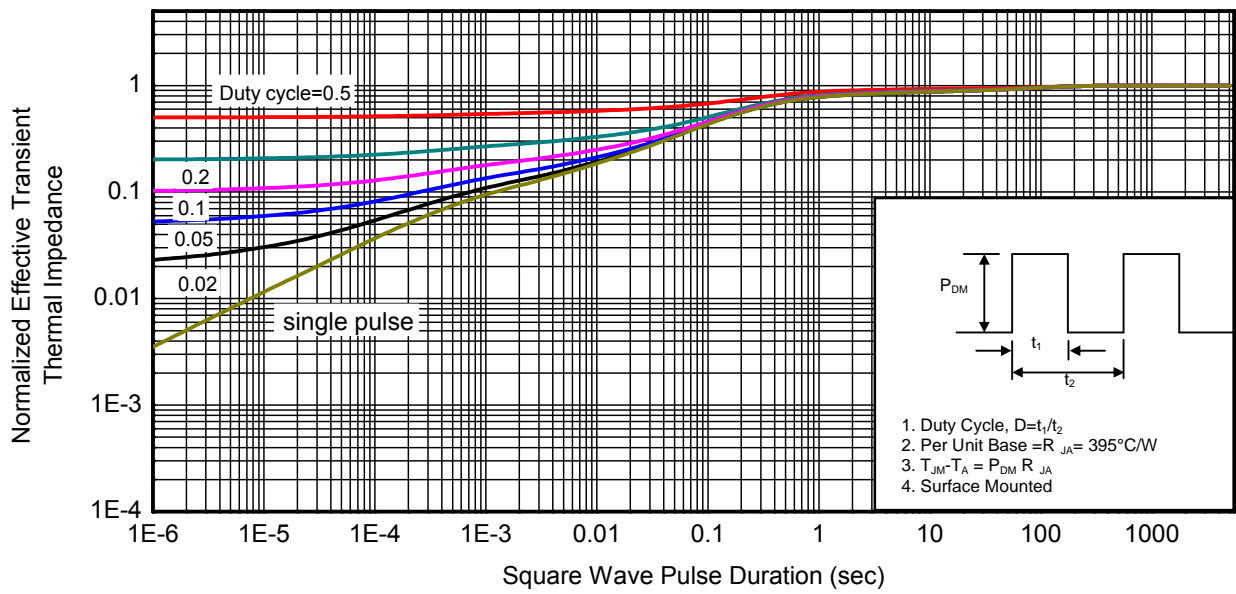
**Transfer characteristics**

**On-Resistance vs. Drain current**

**On-Resistance vs. Gate-to-Source voltage**

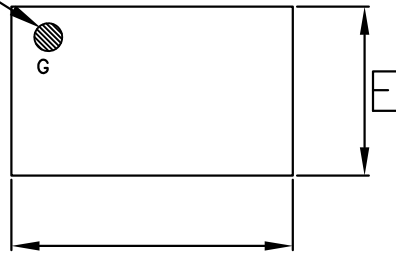
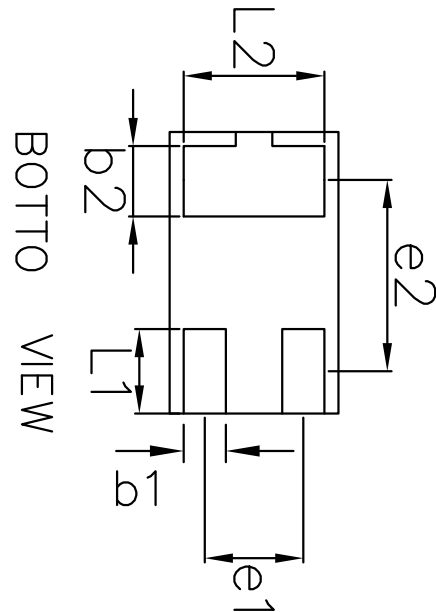
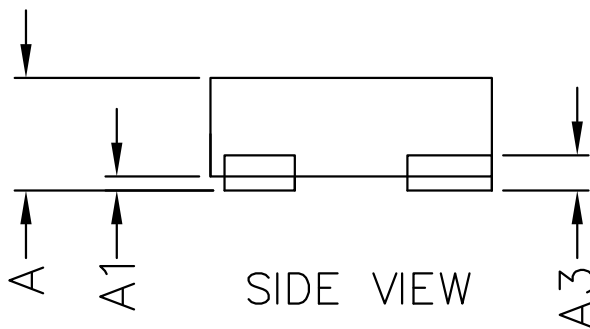
**On-Resistance vs. Junction temperature**

**Threshold voltage vs. Temperature**

**Capacitance**

**Body diode forward voltage**

**Single pulse power**

**Safe operating power**



**Transient thermal response (Junction-to-Ambient)**

**Package outline dimensions**
**DFN1006-3L**

 PIN 1 DOT  
BY MARKIN

**TOP VIEW**

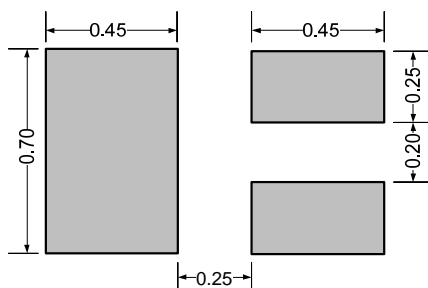
**BOTTO VIEW**

**SIDE VIEW**

COMMON DIMENSIONS(MM)			
PKG.	X1: EXTREME THIN		
REF.	MIN.	NOM.	MAX
A	>0.40	—	0.50
A1	0.00	—	0.05
A3	0.125 REF.		
D	0.95	1.00	1.05
E	0.55	0.60	0.65
b1	0.10	0.15	0.20
b2	0.20	0.25	0.30
L1	0.20	0.30	0.40
L2	0.40	0.50	0.60
e1	0.35 BSC		
e2	0.675 BSC		

**Recommend land pattern (Unit: mm)**

*Note: This land pattern is for your reference only. Actual pad layouts may vary depending on application.*