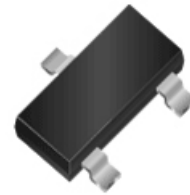
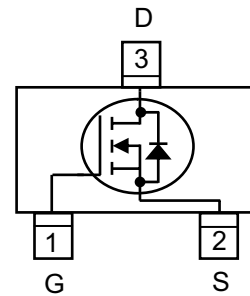

WNM4006
Single N-Channel, 45V, 1.7A, Power MOSFET
[Http://www.willsemi.com](http://www.willsemi.com)

V_{DS} (V)	$R_{ds(on)}$ (Ω)
45	0.126@ $V_{GS}=10V$
	0.142@ $V_{GS}=4.5V$
	0.147@ $V_{GS}=4.0V$
	0.208@ $V_{GS}=2.5V$

SOT-23
Descriptions

The WNM4006 is N-Channel enhancement MOS Field Effect Transistor. Uses advanced trench technology and design to provide excellent $R_{DS(ON)}$ with low gate charge. This device is suitable for use in DC-DC conversion, power switch and charging circuit. Standard Product WNM4006 is Pb-free.

Pin configuration (Top view)
Features

- Trench Technology
- Supper high density cell design
- Excellent ON resistance for higher DC current
- Extremely Low Threshold Voltage
- Small package SOT-23

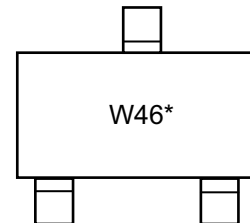

W46 = Device Code
* = Month (A~Z)

Applications

- Driver for Relay, Solenoid, Motor, LED etc.
- DC-DC converter circuit
- Power Switch
- Load Switch
- Charging

Marking
Order information

Device	Package	Shipping
WNM4006-3/TR	SOT-23	3000/Reel&Tape

Absolute Maximum ratings

Parameter		Symbol	10 S	Steady State	Unit
Drain-Source Voltage		V_{DS}	45		V
Gate-Source Voltage		V_{GS}	± 20		
Continuous Drain Current ^a	$T_A=25^\circ\text{C}$	I_D	1.7	1.5	A
	$T_A=70^\circ\text{C}$		1.3	1.2	
Maximum Power Dissipation ^a	$T_A=25^\circ\text{C}$	P_D	0.8	0.7	W
	$T_A=70^\circ\text{C}$		0.5	0.4	
Continuous Drain Current ^b	$T_A=25^\circ\text{C}$	I_D	1.5	1.4	A
	$T_A=70^\circ\text{C}$		1.2	1.1	
Maximum Power Dissipation ^b	$T_A=25^\circ\text{C}$	P_D	0.7	0.6	W
	$T_A=70^\circ\text{C}$		0.4	0.3	
Pulsed Drain Current ^c		I_{DM}	8		A
Operating Junction Temperature		T_J	150		$^\circ\text{C}$
Lead Temperature		T_L	260		$^\circ\text{C}$
Storage Temperature Range		T_{stg}	-55 to 150		$^\circ\text{C}$

Thermal resistance ratings

Parameter		Symbol	Typical	Maximum	Unit
Junction-to-Ambient Thermal Resistance ^a	$t \leq 10 \text{ s}$	$R_{\theta JA}$	120	145	$^\circ\text{C/W}$
	Steady State		132	170	
Junction-to-Ambient Thermal Resistance ^b	$t \leq 10 \text{ s}$	$R_{\theta JA}$	145	174	
	Steady State		158	202	
Junction-to-Case Thermal Resistance		$R_{\theta JC}$	60	75	

a Surface mounted on FR-4 Board using 1 square inch pad size, 1oz copper

b Surface mounted on FR-4 board using minimum pad size, 1oz copper

c Pulse width < 380 μs , Duty Cycle < 2%

d Maximum junction temperature $T_J=150^\circ\text{C}$.

Electronics Characteristics (Ta=25°C, unless otherwise noted)

Parameter	Symbol	Test Conditions	Min	Typ	Max	Unit
OFF CHARACTERISTICS						
Drain-to-Source Breakdown Voltage	BV_{DSS}	$V_{GS} = 0\text{ V}, I_D = 250\mu\text{A}$	45			V
Zero Gate Voltage Drain Current	I_{DSS}	$V_{DS} = 45\text{ V}, V_{GS} = 0\text{ V}$			1	μA
Gate-to-source Leakage Current	I_{GSS}	$V_{DS} = 0\text{ V}, V_{GS} = \pm 20\text{ V}$			100	nA
ON CHARACTERISTICS						
Gate Threshold Voltage	$V_{GS(TH)}$	$V_{GS} = V_{DS}, I_D = 250\mu\text{A}$	0.5	1.2	1.5	V
Drain-to-source On-resistance ^{b, c}	$R_{DS(on)}$	$V_{GS} = 10\text{ V}, I_D = 2.0\text{ A}$		126	160	m Ω
		$V_{GS} = 4.5\text{ V}, I_D = 2.0\text{ A}$		142	180	
		$V_{GS} = 4.0\text{ V}, I_D = 2.0\text{ A}$		147	185	
		$V_{GS} = 2.5\text{ V}, I_D = 1.5\text{ A}$		208	250	
Forward Transconductance	g_{FS}	$V_{DS} = 10\text{ V}, I_D = 2.0\text{ A}$		3		S
CAPACITANCES, CHARGES						
Input Capacitance	C_{ISS}	$V_{GS} = 0\text{ V},$ $f = 1.0\text{ MHz},$ $V_{DS} = 25\text{ V}$		315		pF
Output Capacitance	C_{OSS}			18		
Reverse Transfer Capacitance	C_{RSS}			15		
Total Gate Charge	$Q_{G(TOT)}$	$V_{GS} = 4.5\text{ V},$ $V_{DS} = 25\text{ V},$ $I_D = 2.0\text{ A}$		4.20		nC
Threshold Gate Charge	$Q_{G(TH)}$			0.51		
Gate-to-Source Charge	Q_{GS}			0.76		
Gate-to-Drain Charge	Q_{GD}			1.85		
SWITCHING CHARACTERISTICS						
Turn-On Delay Time	$t_d(ON)$	$V_{GS} = 10\text{ V},$ $V_{DS} = 25\text{ V},$ $R_L = 25\Omega,$ $R_G = 6\Omega$		4.8		ns
Rise Time	t_r			3.0		
Turn-Off Delay Time	$t_d(OFF)$			27		
Fall Time	t_f			2.6		
BODY DIODE CHARACTERISTICS						
Forward Voltage	V_{SD}	$V_{GS} = 0\text{ V}, I_S = 0.8\text{ A}$		0.8	1.5	V

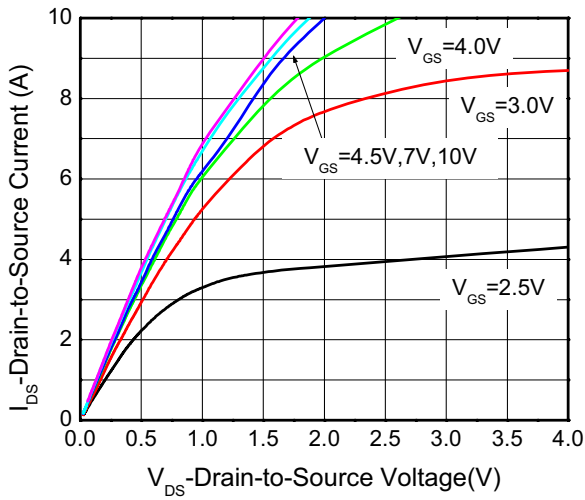
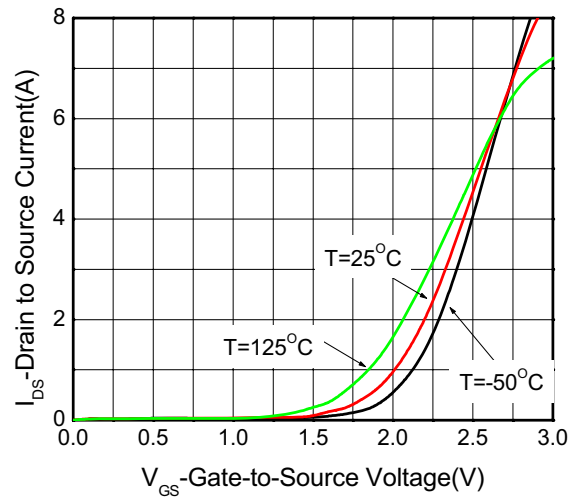
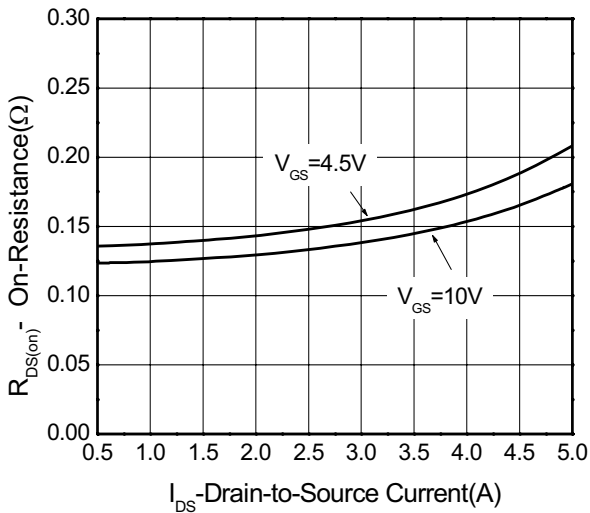
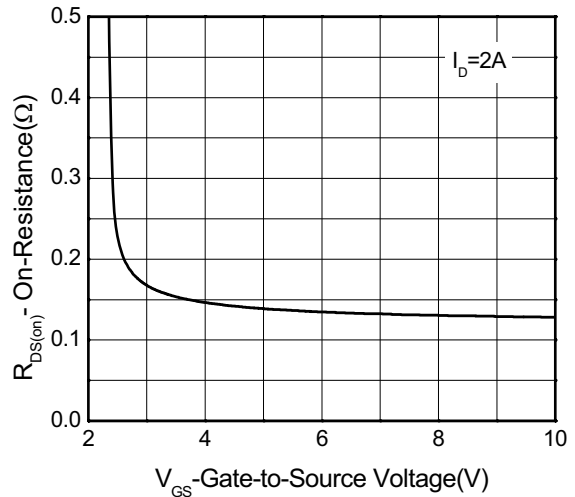
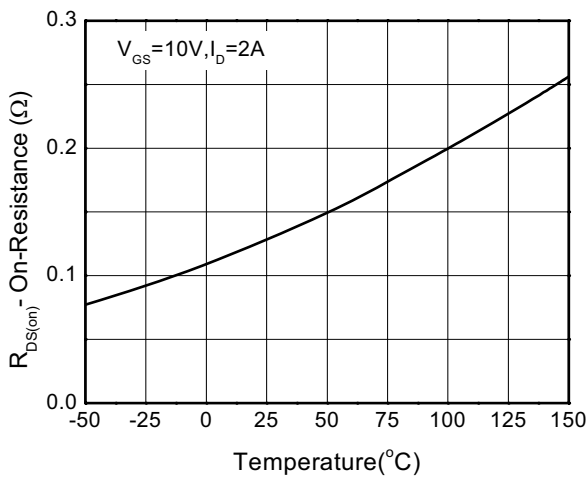
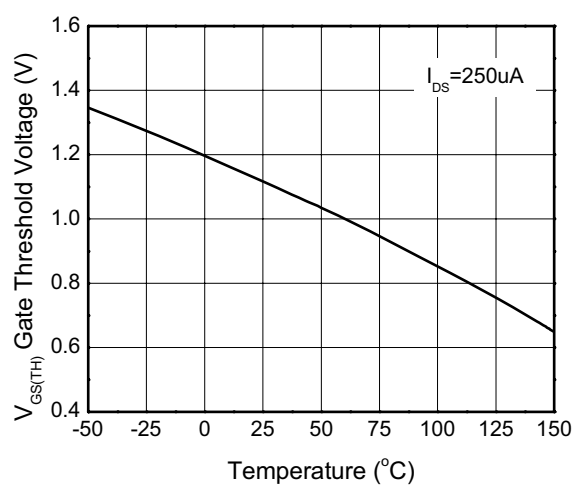
Typical Characteristics (Ta=25°C, unless otherwise noted)

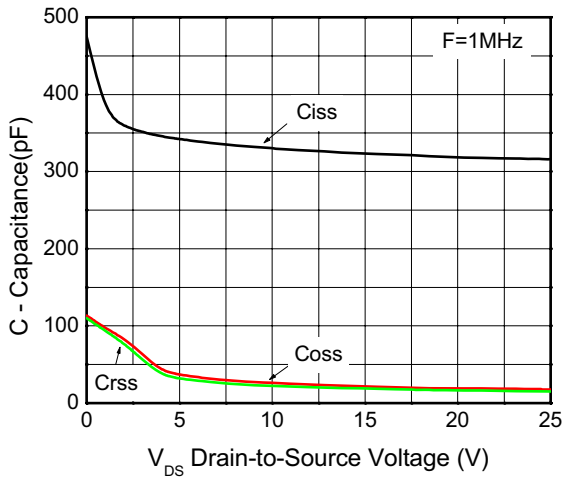
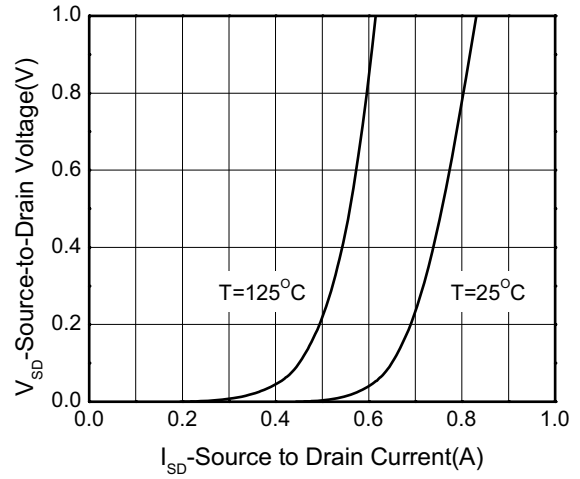
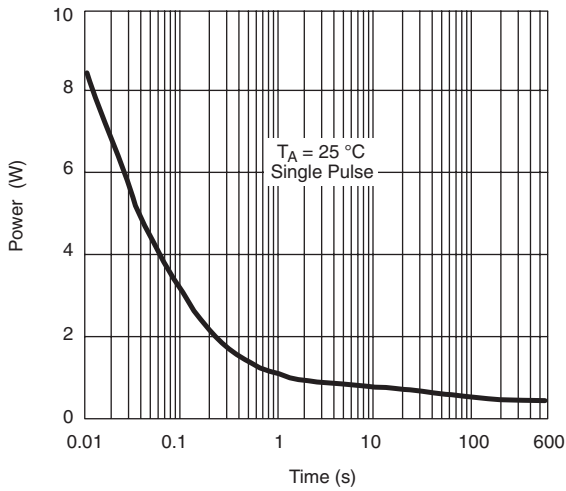
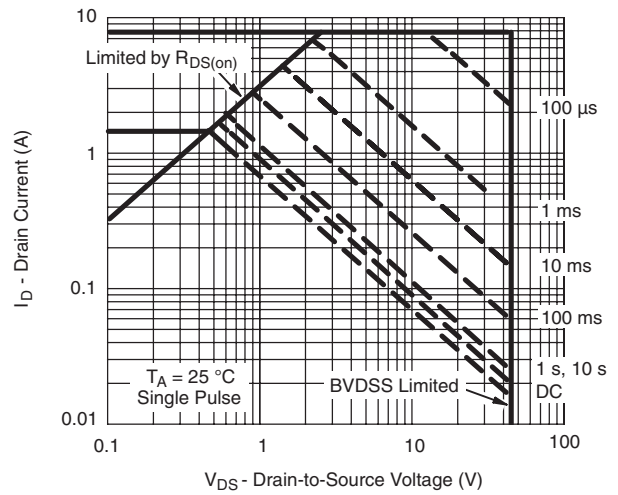
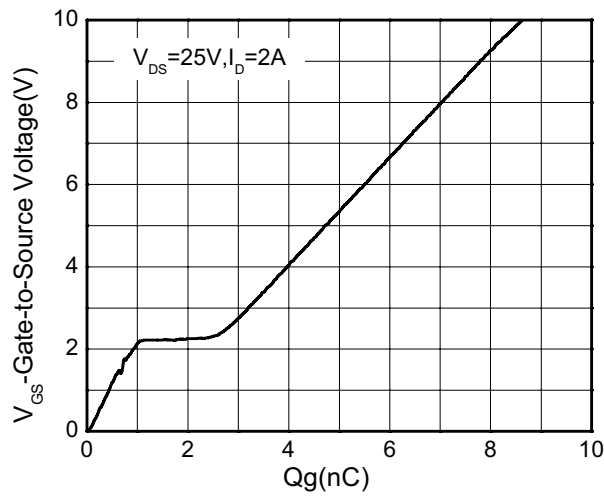
Output characteristics

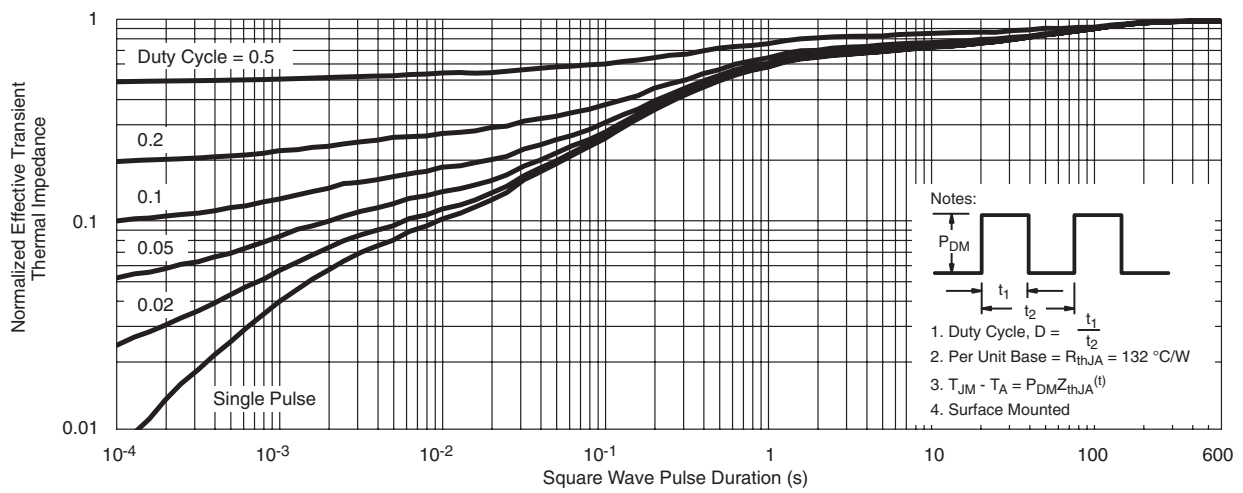
Transfer characteristics

On-Resistance vs. Drain current

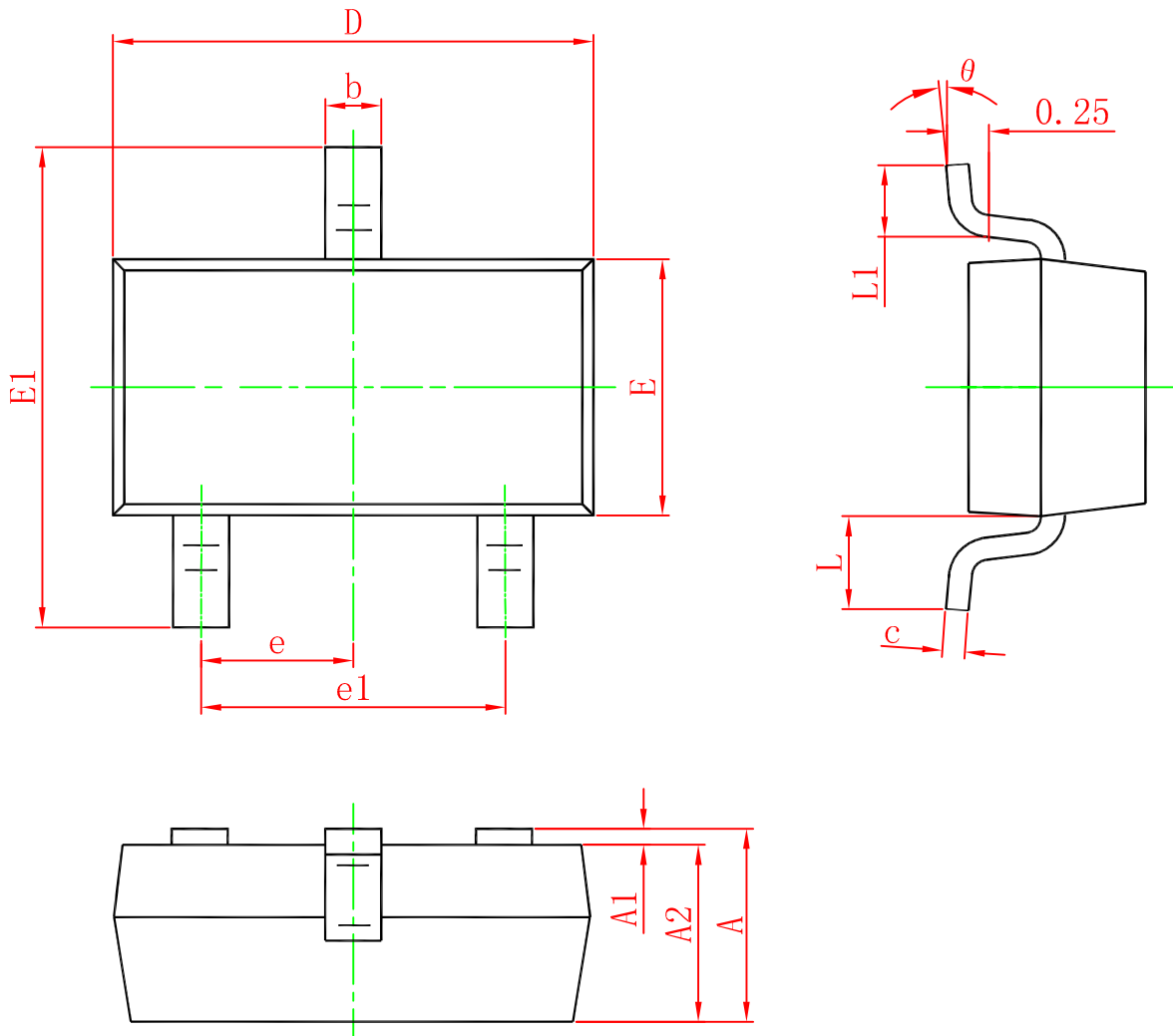
On-Resistance vs. Gate-to-Source voltage

On-Resistance vs. Junction temperature

Threshold voltage vs. Temperature

Capacitance

Body diode forward voltage

Single pulse power

Safe operating power

Gate Charge Characteristics



Transient thermal response (Junction-to-Ambient)

Package outline dimensions
SOT-23

Symbol	Dimensions In Millimeters	
	Min.	Max.
A	0.900	1.150
A1	0.000	0.100
A2	0.900	1.050
b	0.300	0.500
c	0.080	0.150
D	2.800	3.000
E	1.200	1.400
E1	2.250	2.550
e	0.950 (Typ.)	
e1	1.800	2.000
L	0.550 (Typ.)	
L1	0.300	0.500
θ	0°	8°