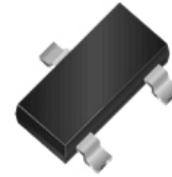
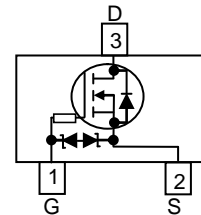

WNM6001
Single N-Channel, 60V, 0.50A, Power MOSFET
[Http://www.sh-willsemi.com](http://www.sh-willsemi.com)

V_{DS} (V)	$R_{ds(on)}$ (Ω)
60	1.4 @ $V_{GS}=10V$
	1.7 @ $V_{GS}=4.5V$
ESD Rating:2000V HBM	

SOT-23
Descriptions

The WNM6001 is N-Channel enhancement MOS Field Effect Transistor. Uses advanced trench technology and design to provide excellent $R_{DS(ON)}$ with low gate charge. This device is suitable for use in DC-DC conversion, power switch and charging circuit. Standard Product WNM6001 is Pb-free and Halogen-free.

Features

- Trench Technology
- Supper high density cell design
- Excellent ON resistance for higher DC current
- Extremely Low Threshold Voltage
- Small package SOT-23

Applications

- Driver for Relay, Solenoid, Motor, LED etc.
- DC-DC converter circuit
- Power Switch
- Load Switch
- Charging

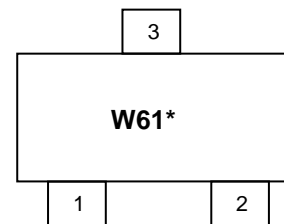
Pin configuration (Top view)

W61 = Device Code
* = Month (A~Z)

Marking
Order information

Device	Package	Shipping
WNM6001-3/TR	SOT-23	3000/Reel&Tape

Absolute Maximum ratings

Parameter		Symbol	10 s	Steady State	Unit
Drain-Source Voltage		V_{DS}	60		V
Gate-Source Voltage		V_{GS}	± 20		
Continuous Drain Current ^{ad}	$T_A=25^\circ\text{C}$	I_D	0.50	0.44	A
	$T_A=70^\circ\text{C}$		0.40	0.35	
Maximum Power Dissipation ^{ad}	$T_A=25^\circ\text{C}$	P_D	0.69	0.53	W
	$T_A=70^\circ\text{C}$		0.44	0.34	
Continuous Drain Current ^{bd}	$T_A=25^\circ\text{C}$	I_D	0.47	0.42	A
	$T_A=70^\circ\text{C}$		0.38	0.33	
Maximum Power Dissipation ^{bd}	$T_A=25^\circ\text{C}$	P_D	0.60	0.47	W
	$T_A=70^\circ\text{C}$		0.39	0.30	
Pulsed Drain Current ^c		I_{DM}	1.0		A
Operating Junction Temperature		T_J	-55 to 150		$^\circ\text{C}$
Lead Temperature		T_L	260		$^\circ\text{C}$
Storage Temperature Range		T_{stg}	-55 to 150		$^\circ\text{C}$

Thermal resistance ratings

Parameter		Symbol	Typical	Maximum	Unit
Junction-to-Ambient Thermal Resistance ^a	$t \leq 10$ s	$R_{\theta JA}$	140	180	$^\circ\text{C/W}$
	Steady State		176	232	
Junction-to-Ambient Thermal Resistance ^b	$t \leq 10$ s	$R_{\theta JA}$	165	205	
	Steady State		198	261	
Junction-to-Case Thermal Resistance		$R_{\theta JC}$	100	120	

a Surface mounted on FR-4 Board using 1 square inch pad size, 1oz copper

b Surface mounted on FR-4 board using minimum pad size, 1oz copper

c Pulse width < 380 μs

d Maximum junction temperature $T_J=150^\circ\text{C}$.

Electronics Characteristics (Ta=25°C, unless otherwise noted)

Parameter	Symbol	Test Conditions	Min	Typ	Max	Unit
OFF CHARACTERISTICS						
Drain-to-Source Breakdown Voltage	BV_{DSS}	$V_{GS} = 0\text{ V}, I_D = 250\mu\text{A}$	60			V
Zero Gate Voltage Drain Current	I_{DSS}	$V_{DS} = 60\text{ V}, V_{GS} = 0\text{ V}$			1	μA
Gate-to-source Leakage Current	I_{GSS}	$V_{DS} = 0\text{ V}, V_{GS} = \pm 20\text{ V}$			± 5	μA
ON CHARACTERISTICS						
Gate Threshold Voltage	$V_{GS(TH)}$	$V_{GS} = V_{DS}, I_D = 250\mu\text{A}$	0.8	1.3	2	V
Drain-to-source On-resistance ^{b, c}	$R_{DS(on)}$	$V_{GS} = 10\text{ V}, I_D = 0.5\text{ A}$		1.4	2.0	Ω
		$V_{GS} = 4.5\text{ V}, I_D = 0.2\text{ A}$		1.7	2.6	
Forward Transconductance	g_{FS}	$V_{DS} = 15\text{ V}, I_D = 0.25\text{ A}$		0.42		S
CAPACITANCES, CHARGES						
Input Capacitance	C_{ISS}	$V_{GS} = 0\text{ V},$ $f = 1.0\text{ MHz},$ $V_{DS} = 25\text{ V}$		23.37		pF
Output Capacitance	C_{OSS}			7.33		
Reverse Transfer Capacitance	C_{RSS}			5.2		
Total Gate Charge	$Q_{G(TOT)}$	$V_{GS} = 10\text{ V},$ $V_{DD} = 30\text{ V},$ $I_D = 0.37\text{ A}$		1.2		nC
Threshold Gate Charge	$Q_{G(TH)}$			0.15		
Gate-to-Source Charge	Q_{GS}			0.21		
Gate-to-Drain Charge	Q_{GD}			0.12		
SWITCHING CHARACTERISTICS						
Turn-On Delay Time	$t_d(ON)$	$V_{DD} = 30\text{ V}, I_D = 0.2\text{ A},$ $V_{GEN} = 10\text{ V}, R_G = 10\ \Omega$		7.6		ns
Rise Time	t_r			5.1		
Turn-Off Delay Time	$t_d(OFF)$			24.6		
Fall Time	t_f			10		
BODY DIODE CHARACTERISTICS						
Forward Voltage	V_{SD}	$V_{GS} = 0\text{ V}, I_S = 0.3\text{ A}$		0.9	1.5	V

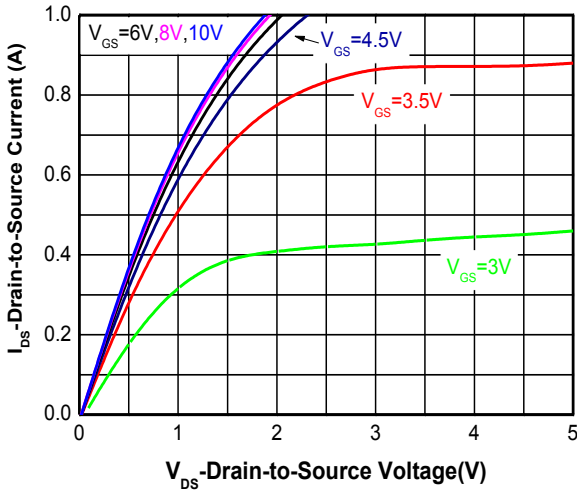
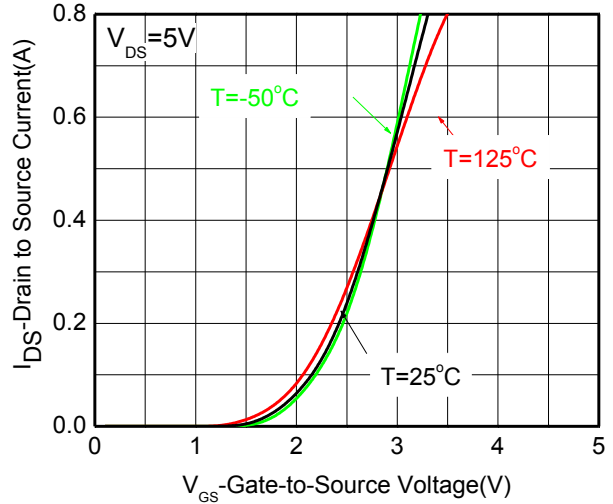
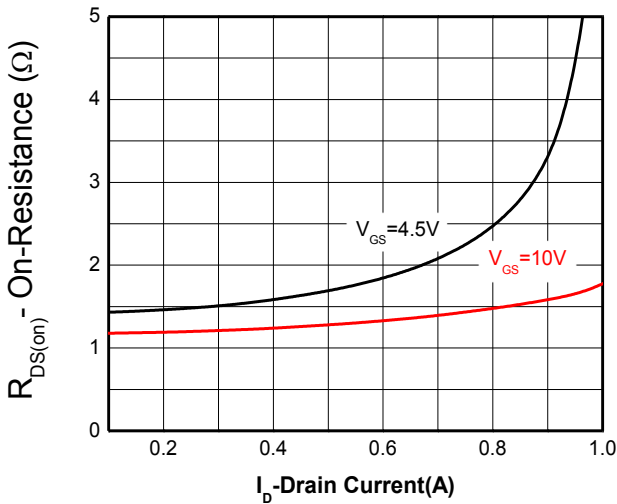
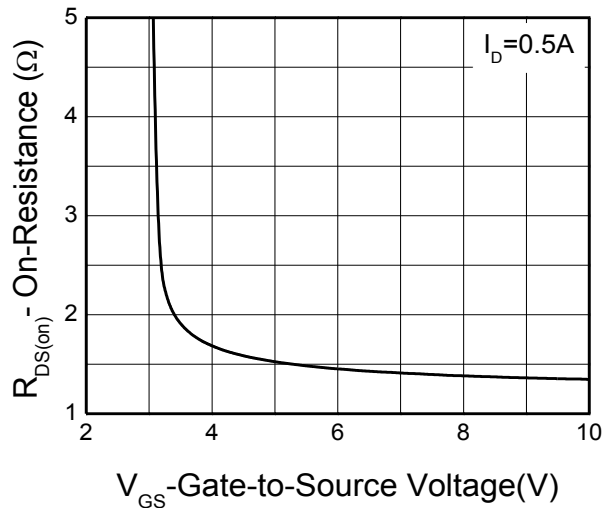
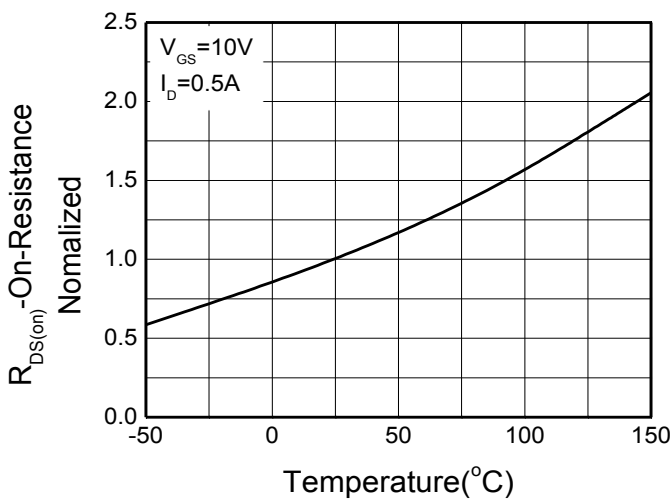
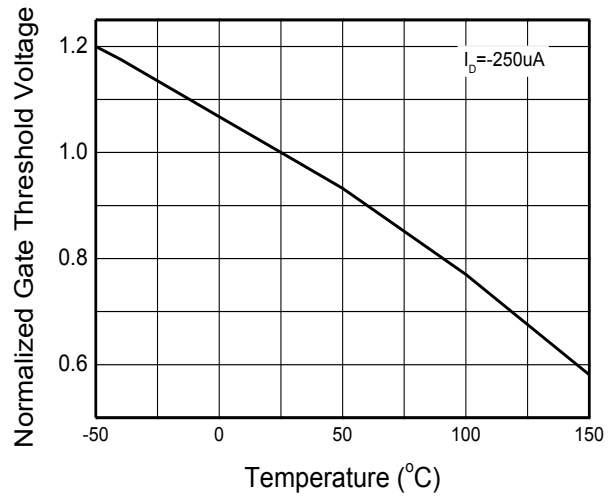
Typical Characteristics (Ta=25°C, unless otherwise noted)

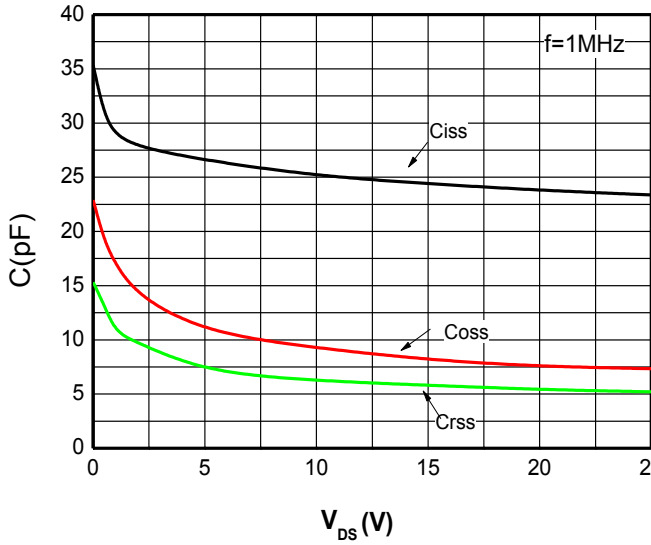
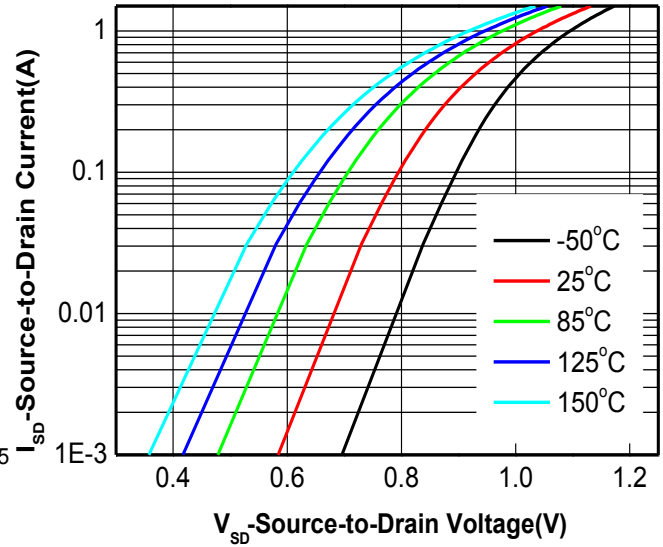
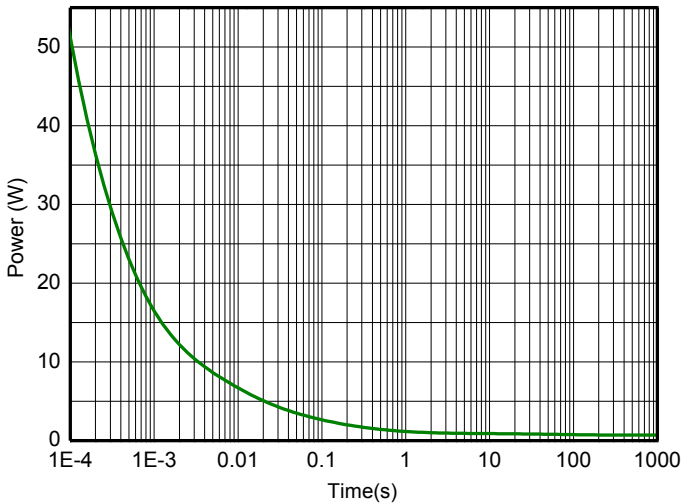
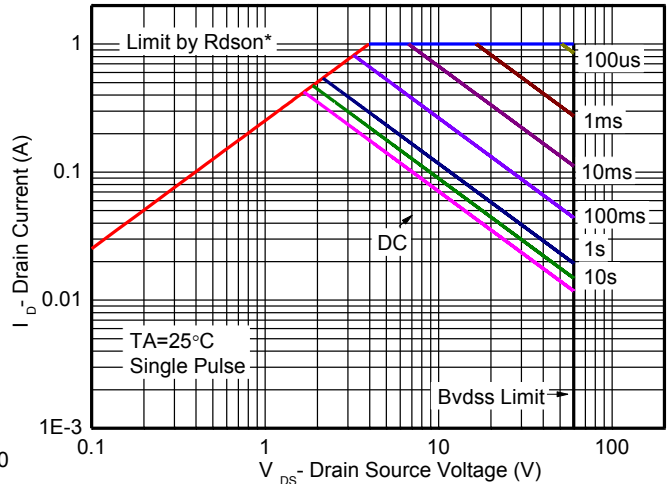
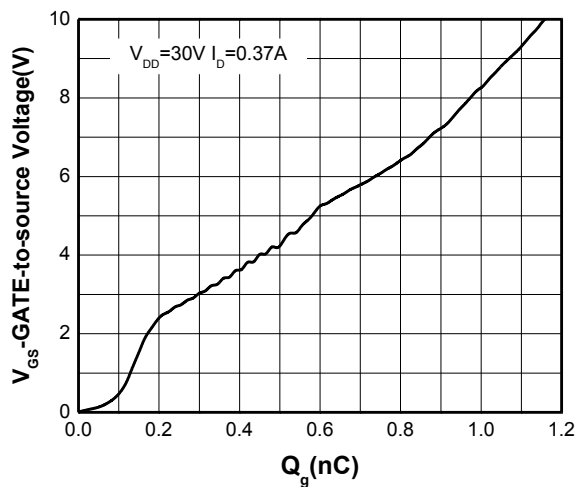
Output characteristics

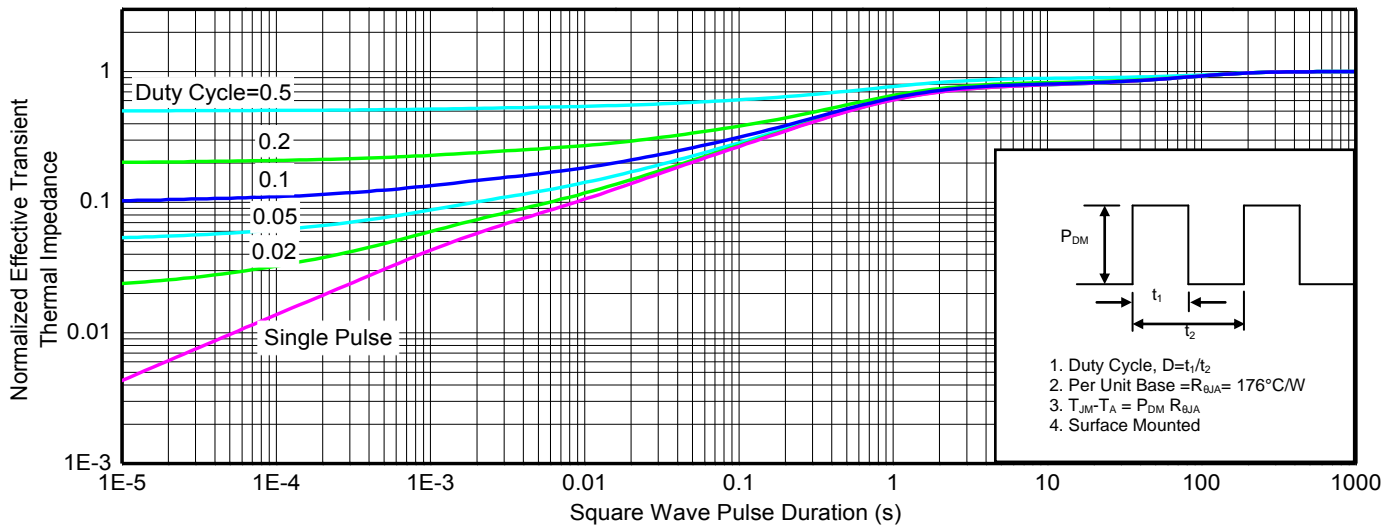
Transfer characteristics

On-Resistance vs. Drain current

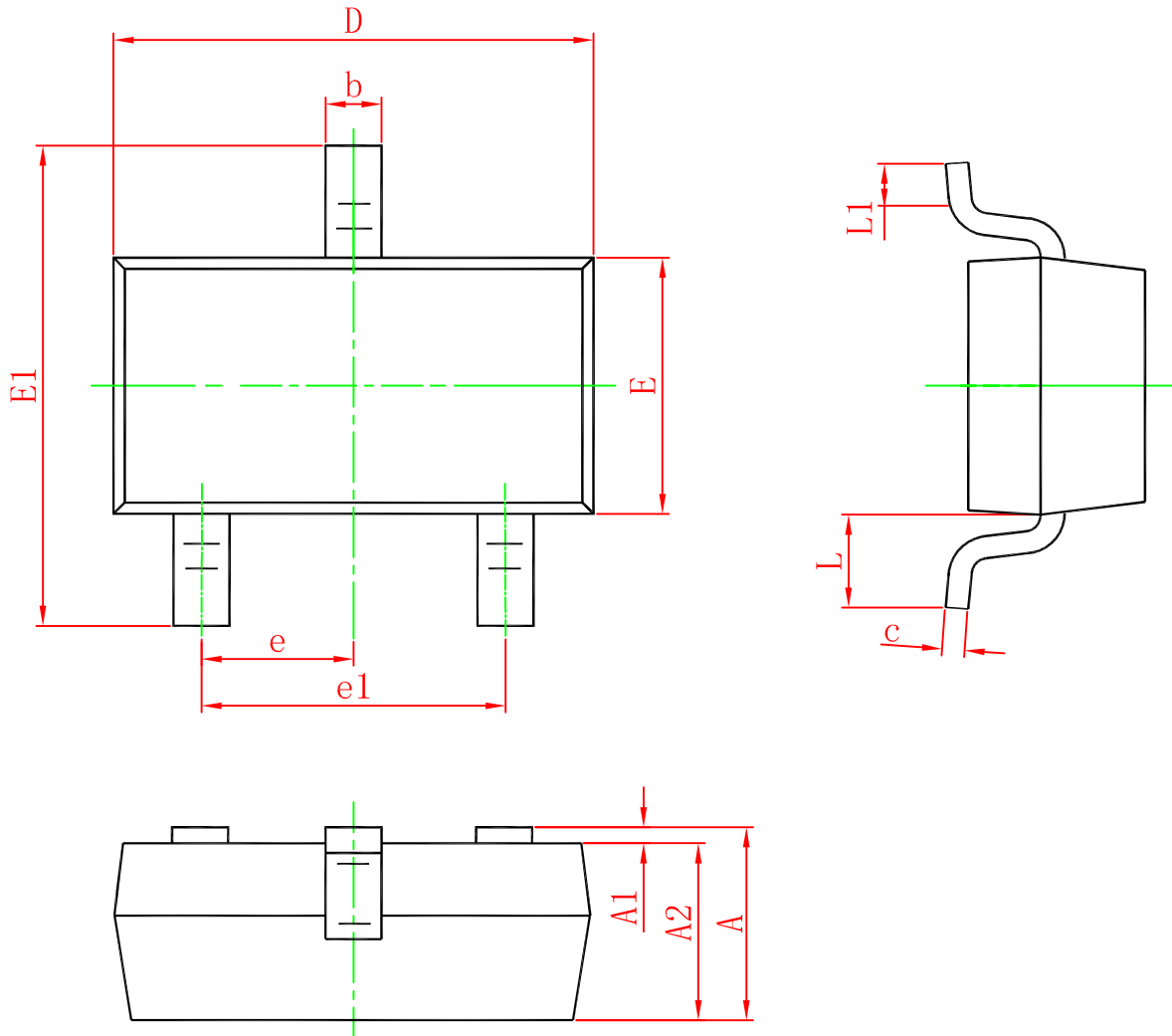
On-Resistance vs. Gate-to-Source voltage

On-Resistance vs. Junction temperature

Threshold voltage vs. Temperature

Capacitance

Body diode forward voltage

Single pulse power

Safe operating power

Gate Charge Characteristics



Transient thermal response (Junction-to-Ambient)

Package outline dimensions
SOT-23

Symbol	Dimensions in millimeter	
	Min.	Max.
A	0.890	1.200
A1	0.013	0.100
b	0.370	0.510
c	0.080	0.190
D	2.800	3.040
E	1.200	1.400
E1	2.200	2.600
e	0.890	1.020
e1	1.780	2.040
L1	0.2 MIN.	