

### PRELIMINARY SPEC

Part Number: WP93A8EWP/RWC/A-TG0L White



**ATTENTION**  
OBSERVE PRECAUTIONS  
FOR HANDLING  
ELECTROSTATIC  
DISCHARGE  
SENSITIVE  
DEVICES

### Features

- I.C. COMPATIBLE.
- BLACK CASE ENHANCES CONTRAST RATIO.
- HIGH RELIABILITY LIFE MEASURED IN YEARS.
- HOUSING MATERIAL: PPA
- PACKAGE : 500PCS / REEL.
- HIGH TEMPERATURE RESISTANT HOUSING.
- HIGH GLASS TRANSITION TEMPERATURE EPOXY.
- MOISTURE SENSITIVITY LEVEL : LEVEL 1.
- ELECTROSTATIC DISCHARGE THRESHOLD (HBM):1000V.
- TYP. COLOR TEMPERATURE: 6500K
- COLOR COORDINATES:X=0.31,Y=0.31 ACC. TO CIE1931(WHITE).
- OPTICAL EFFICIENCY: 8.6lm/W(TYP.)
- COLOR REPRODUCTION INDEX: 80
- RoHS COMPLIANT.

### Description

The source color devices are made with InGaN on SiC Light Emitting Diode.

Static electricity and surge damage the LEDs.

It is recommended to use a wrist band or anti-electrostatic glove when handling the LEDs.

All devices, equipment and machinery must be electrically grounded.

### Applications

- Furniture lighting
- Outdoor displays
- Optical indicators
- Signal and symbol luminaire
- Marker lights (e.g. steps, exit ways, etc.)
- Lighting for special effects (e.g. starry sky)
- Substitute for miniature flashlight

### Package Dimensions

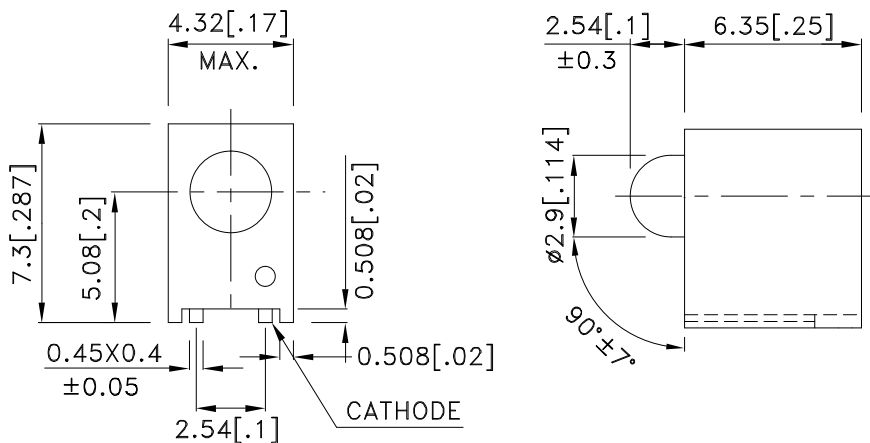

#### Notes:

1. All dimensions are in millimeters (inches).
2. Tolerance is ±0.25(0.01") unless otherwise noted.
3. Specifications are subject to change without notice.



## Selection Guide

Part No.	Dice	Lens Type	luminous Intensity <sup>Note2</sup> Iv(mcd) @ 20 mA		$\Phi_v$ (mlm) <sup>Note3</sup> @ 20 mA	Viewing Angle <sup>Note1</sup>
			Min.	Typ.	Typ.	2 $\theta$ 1/2
WP93A8EWP/RWC/A-TG0L	WHITE (InGaN)	WATER CLEAR	280	800	550	30°

## Absolute Maximum Ratings at TA=25°C

Parameter	Symbol	Value	Unit
Power dissipation	Pt	120	mW
Reverse Voltage	VR	5	V
Junction temperature	TJ	110	°C
Operating Temperature	Top	-40 To +85	°C
Storage Temperature	Tstg	-40 To +100	°C
DC Forward Current	IF	30	mA
Peak Forward Current <sup>Note4</sup>	IFM	100	mA
Thermal resistance Junction/ambient <sup>Note5</sup>	Rth JA	350	°C/W

### Notes:

1.  $\theta$  1/2 is the angle from optical centerline where the luminous intensity is 1/2 the optical centerline value.
2. Luminous intensity is measured by a current pulse of 10ms at a tolerance of  $\pm 15\%$ .
3. The typical data of Luminous Flux can only reflect statistical figures, actual parameters of individual product could differ from the typical data. For the purpose of product enhancement, the typical data is subject to change without prior notice.
4. 1/10 Duty Cycle, 0.1ms Pulse Width.
5. Rth(J-A) Results from mounting on PC board FR4 (pad size  $\geq 16 \text{ mm}^2$  per pad),

## Electrical / Optical Characteristics at TA=25°C

Parameter	Symbol	Value	Unit
Chromaticity coordinate x acc.to CIE1931 IF=20mA [Typ.]	X <sup>Note1</sup>	0.31	-
Chromaticity coordinate y acc.to CIE1931 IF=20mA [Typ.]	Y <sup>Note1</sup>	0.31	-
Forward Voltage IF=20mA [Min.]	VF <sup>Note2</sup>	2.7	V
Forward Voltage IF=20mA [Typ.]		3.2	
Forward Voltage IF=20mA [Max.]		4.0	
Reverse Current (VR=5V) [Typ.]	IR	0.01	$\mu$ A
Reverse Current (VR=5V) [Max.]		10	
Temperature coefficient of x IF=20mA, $-10^\circ \text{C} \leq T \leq 100^\circ \text{C}$ [Typ.]	TCx	-0.1	$10^{-3}/^\circ \text{C}$
Temperature coefficient of y IF=20mA, $-10^\circ \text{C} \leq T \leq 100^\circ \text{C}$ [Typ.]	TCy	-0.2	$10^{-3}/^\circ \text{C}$
Temperature coefficient of VF IF=20mA, $-10^\circ \text{C} \leq T \leq 100^\circ \text{C}$ [Typ.]	TCv	-2.5	mV/ $^\circ \text{C}$

### Notes:

1. Chromaticity coordinates are measured by a current pulse of 20ms with a tolerance of  $\pm 0.02$  in X and Y color coordinates.
2. Forward voltage is measured with a current pulse of 10ms at a tolerance of  $\pm 0.1\text{V}$ .

## Brightness codes

Code.	Luminous Intensity <sup>Note1</sup> Iv(mcd) @ 20mA		$\Phi_v$ (mlm) <sup>Note2</sup> @ 20mA
	Min.	Max.	Typ.
Q	280	420	200
R	380	550	300
S	480	750	400
T	650	1100	500
U	900	1500	600
V	1200	1800	800
W	1500	2100	1000
X	1800	2500	1200
Y	2200	3000	1400
Z	2500	3300	1600
ZA	2800	3800	1800

**Notes:**

- Luminous intensity is measured by a current pulse of 10ms at a tolerance of  $\pm 15\%$ .
- The typical data of Luminous Flux can only reflect statistical figures, actual parameters of individual product could differ from the typical data. For the purpose of product enhancement, the typical data is subject to change without prior notice.

**White**

**WP93A8EWP/RWC/A-TG0L**

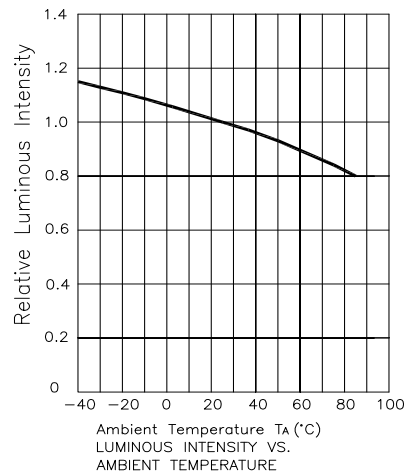
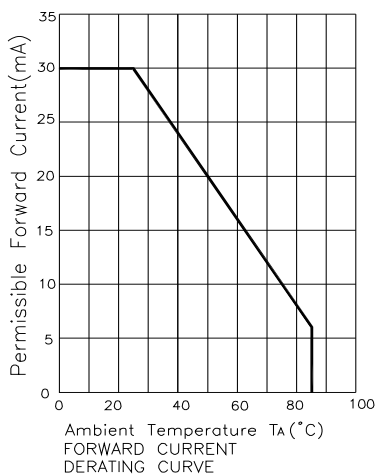
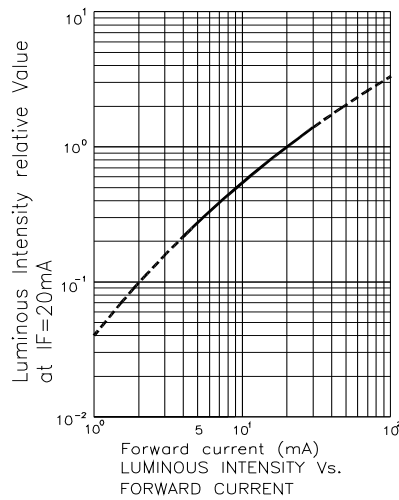
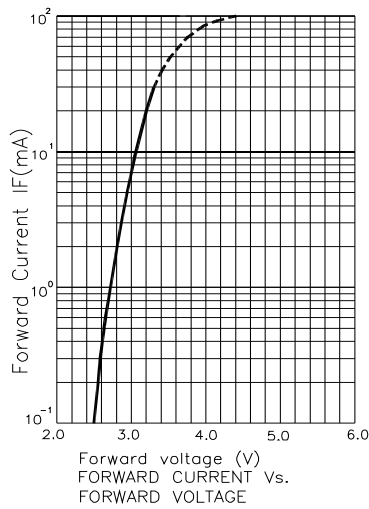

## WP93A8EWP/RWC/A-TG0L

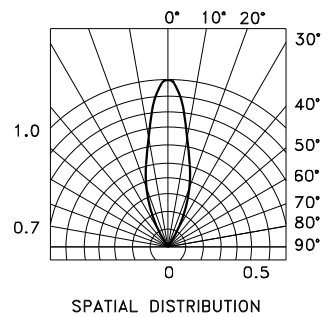
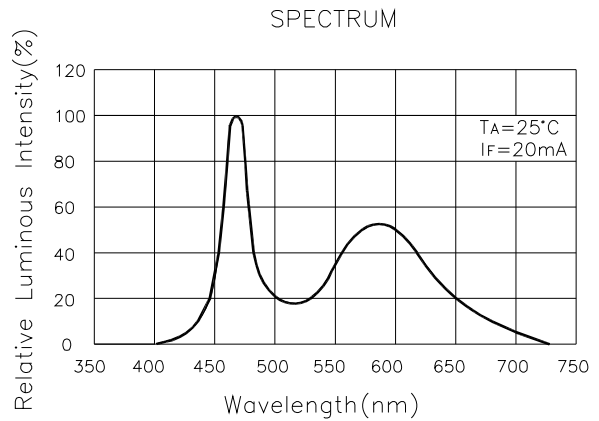
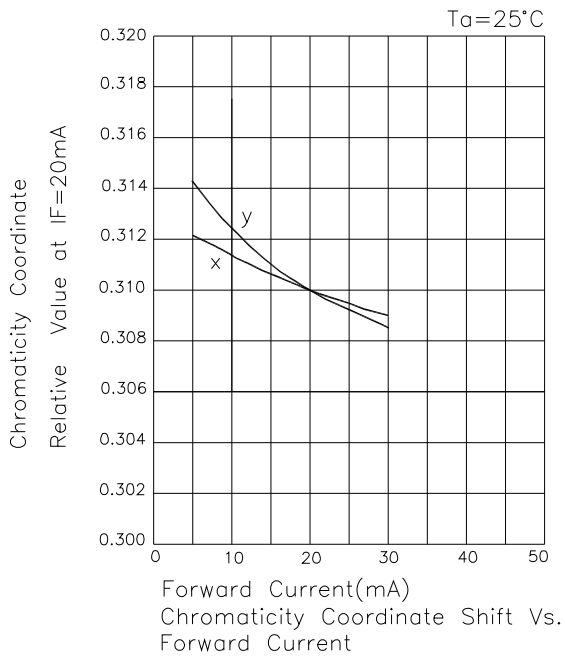
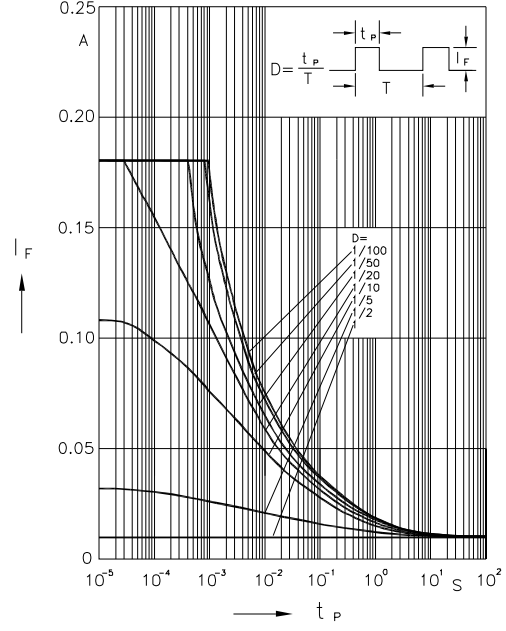
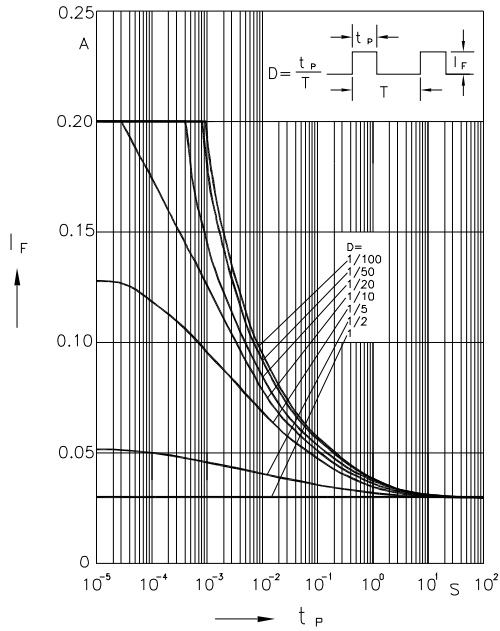

WP93A8EWP/RWC/A-TG0L

## White CIE

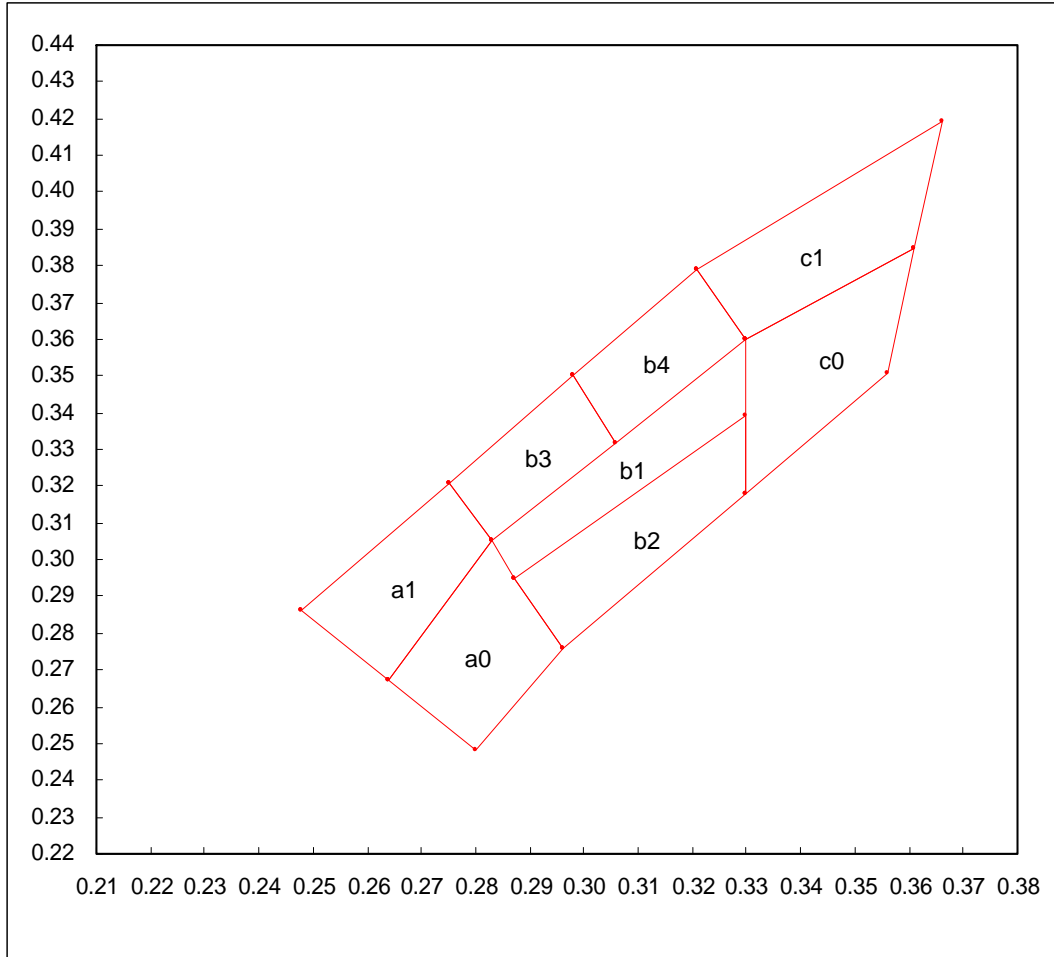

a0				
X	0.264	0.283	0.296	0.280
Y	0.267	0.305	0.276	0.248
Reference CCT: 14000~9000k				

a1				
X	0.248	0.275	0.283	0.264
Y	0.286	0.321	0.305	0.267
Reference CCT: 14000~9000k				

b1				
X	0.283	0.330	0.330	0.287
Y	0.305	0.360	0.339	0.295
Reference CCT: 9000~5600k				

b2				
X	0.287	0.330	0.330	0.296
Y	0.295	0.339	0.318	0.276
Reference CCT: 9000~5600k				

b3				
X	0.275	0.298	0.306	0.283
Y	0.321	0.350	0.332	0.305
Reference CCT: 9000~7000k				

b4				
X	0.298	0.321	0.330	0.306
Y	0.350	0.379	0.360	0.332
Reference CCT: 7600~5600k				

c0				
X	0.330	0.361	0.356	0.330
Y	0.360	0.385	0.351	0.318
Reference CCT: 5600~4600k				

c1				
X	0.321	0.366	0.361	0.330
Y	0.379	0.419	0.385	0.360
Reference CCT: 6000~4600k				

## WP93A8EWP/RWC/A-TG0L

Reflow Soldering Profile For Lead-free SMT Process.

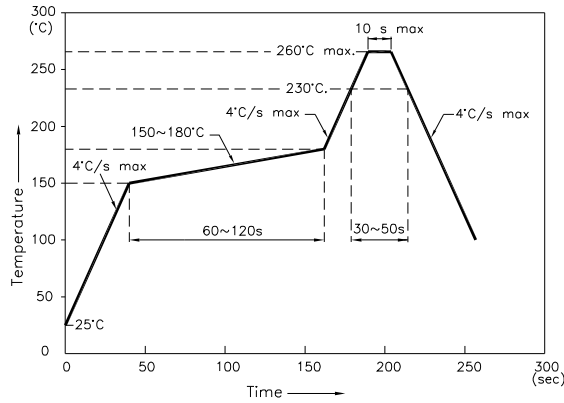

NOTES:

1. We recommend the reflow temperature 245°C(+/-5°C). The maximum soldering temperature should be limited to 260°C.
2. Don't cause stress to the epoxy resin while it is exposed to high temperature.
3. Number of reflow process shall be 2 times or less.

### Recommended Soldering Pattern (Units : mm; Tolerance: ± 0.1)

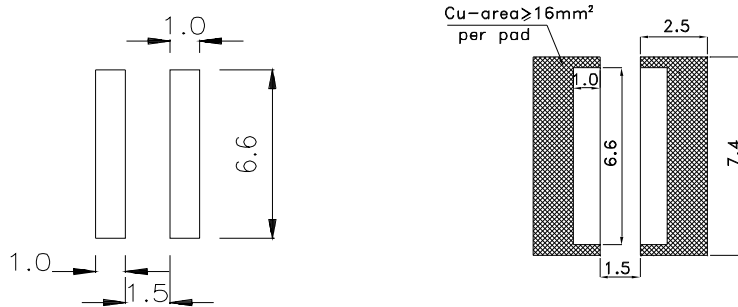

### Tape Specifications (Units : mm)

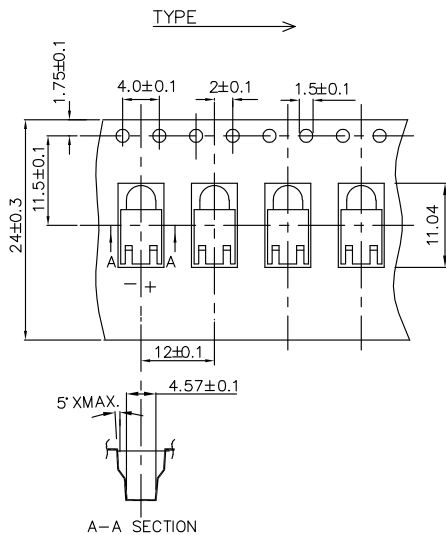

### Reel Dimension

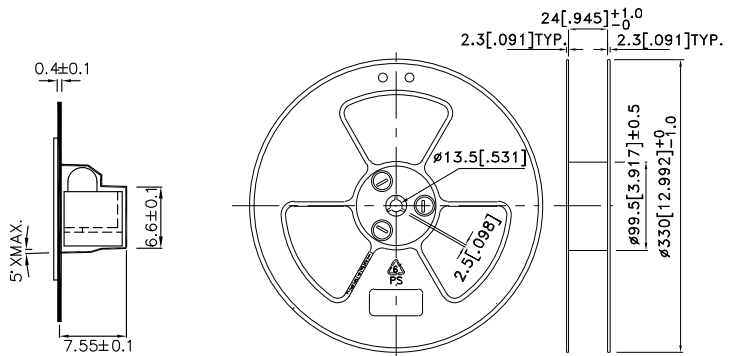

**PACKING & LABEL SPECIFICATIONS**

**WP93A8EWP/RWC/A-TG0L**

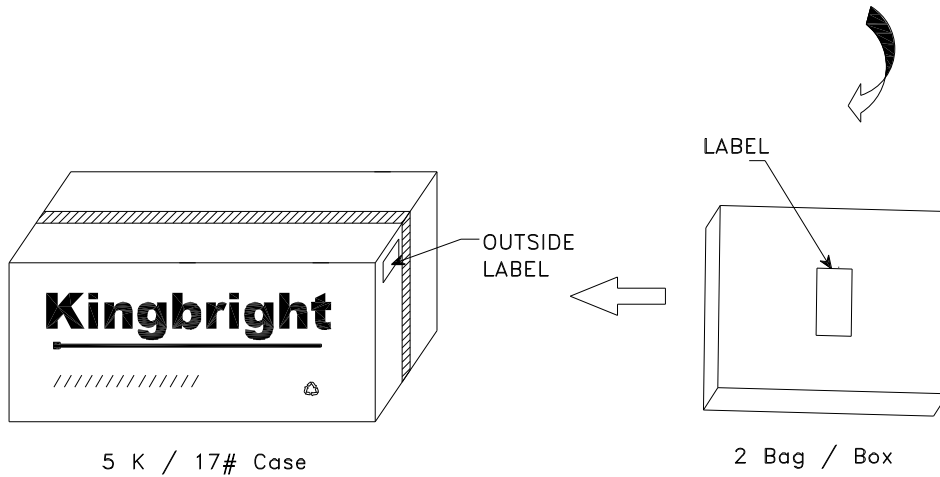
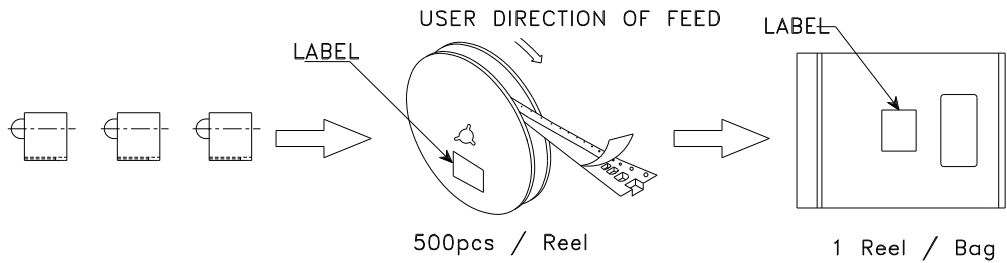

<h1 style="margin: 0;">Kingbright</h1>				
Q.C.	<table border="1" style="margin: 0; width: 50px; height: 30px;"> <tr> <td style="text-align: center; font-size: 8px;">QC</td> </tr> <tr> <td style="text-align: center; font-size: 8px;">xx xx xxxx</td> </tr> <tr> <td style="text-align: center; font-size: 8px;">PASSED</td> </tr> </table>	QC	xx xx xxxx	PASSED
QC				
xx xx xxxx				
PASSED				
TYPE NO : WP93A8EWPxxx				
QUANTITY : 500 pcs				
S/N :       XXX	CODE:   XXX			
LOT NO:				
RoHS Compliant				