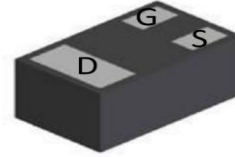
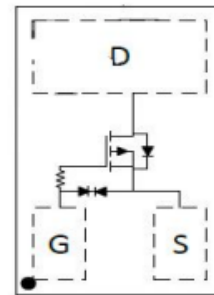

WPM2049B
Single P-Channel, -20V, -0.51A, Power MOSFET
[Http://www.sh-willsemi.com](http://www.sh-willsemi.com)

V_{DS} (V)	Typical $R_{DS(on)}$ (Ω)
-20	0.440 @ $V_{GS}=-4.5V$
	0.640 @ $V_{GS}=-2.5V$
	0.880 @ $V_{GS}=-1.8V$

DFN1006-3L
Descriptions

The WPM2049B is P-Channel enhancement MOS Field Effect Transistor. Uses advanced trench technology and design to provide excellent $R_{DS(ON)}$ with low gate charge. This device is suitable for use in DC-DC conversion, power switch and charging circuit. Standard Product WPM2049B is Pb-free and Halogen-free.

Features

- Trench Technology
- ESD protection up to 2 kV
- Supper high density cell design
- Excellent ON resistance for higher DC current
- Extremely Low Threshold Voltage
- Small package DFN1006-3L

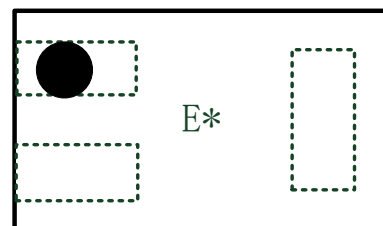
Pin configuration (Top view)

E = Device Code

* = Month (A~Z)

Marking
Order information

Device	Package	Shipping
WPM2049B-3/TR	DFN1006-3L	10K/Reel&Tape

Applications

- Driver for Relay, Solenoid, Motor, LED etc.
- DC-DC converter circuit
- Power Switch
- Load Switch
- Charging

Absolute Maximum ratings

Parameter		Symbol	10 S	Steady State	Unit
Drain-Source Voltage		V_{DS}	-20		V
Gate-Source Voltage		V_{GS}	± 5		
Continuous Drain Current ^{a d}	$T_A=25^\circ\text{C}$	I_D	-0.51	-0.47	A
	$T_A=70^\circ\text{C}$		-0.41	-0.38	
Maximum Power Dissipation ^{a d}	$T_A=25^\circ\text{C}$	P_D	0.31	0.27	W
	$T_A=70^\circ\text{C}$		0.20	0.17	
Continuous Drain Current ^{b d}	$T_A=25^\circ\text{C}$	I_D	-0.48	-0.45	A
	$T_A=70^\circ\text{C}$		-0.38	-0.36	
Maximum Power Dissipation ^{b d}	$T_A=25^\circ\text{C}$	P_D	0.28	0.24	W
	$T_A=70^\circ\text{C}$		0.18	0.15	
Pulsed Drain Current ^c		I_{DM}	-1.2		A
Operating Junction Temperature		T_J	150		$^\circ\text{C}$
Lead Temperature		T_L	260		$^\circ\text{C}$
Storage Temperature Range		T_{stg}	-55 to 150		$^\circ\text{C}$

Thermal resistance ratings

Parameter		Symbol	Typical	Maximum	Unit
Junction-to-Ambient Thermal Resistance ^a	$t \leq 10 \text{ s}$	$R_{\theta JA}$	340	395	$^\circ\text{C/W}$
	Steady State		390	455	
Junction-to-Ambient Thermal Resistance ^b	$t \leq 10 \text{ s}$	$R_{\theta JA}$	387	441	
	Steady State		445	505	
Junction-to-Case Thermal Resistance		$R_{\theta JC}$	240	285	

a Surface mounted on FR4 Board using 1 square inch pad size, 1oz copper

b Surface mounted on FR4 board using minimum pad size, 1oz copper

c Pulse width < 380 μs , Single pulse

d Maximum junction temperature $T_J=150^\circ \text{C}$.

e Pulse test: Pulse width < 380 us duty cycle < 2%.

Electronics Characteristics (Ta=25°C, unless otherwise noted)

Parameter	Symbol	Test Conditions	Min	Typ	Max	Unit
OFF CHARACTERISTICS						
Drain-to-Source Breakdown Voltage	BV_{DSS}	$V_{GS} = 0\text{ V}, I_D = -250\mu\text{A}$	-20			V
Zero Gate Voltage Drain Current	I_{DSS}	$V_{DS} = -16\text{ V}, V_{GS} = 0\text{ V}$			-1	μA
Gate-to-source Leakage Current	I_{GSS}	$V_{DS} = 0\text{ V}, V_{GS} = \pm 5\text{ V}$			± 5	μA
ON CHARACTERISTICS						
Gate Threshold Voltage	$V_{GS(TH)}$	$V_{GS} = V_{DS}, I_D = -250\mu\text{A}$	-0.45	-0.55	-0.85	V
Drain-to-source On-resistance ^e	$R_{DS(on)}$	$V_{GS} = -4.5\text{ V}, I_D = -0.45\text{ A}$		440	700	m Ω
		$V_{GS} = -2.5\text{ V}, I_D = -0.35\text{ A}$		640	900	
		$V_{GS} = -1.8\text{ V}, I_D = -0.25\text{ A}$		880	1230	
Forward Transconductance	g_{FS}	$V_{DS} = -5\text{ V}, I_D = -0.45\text{ A}$		1.25		S
CHARGES, CAPACITANCES AND GATE RESISTANCE						
Input Capacitance	C_{ISS}	$V_{GS} = 0\text{ V}, f = 1.0\text{ MHz}, V_{DS} = -10\text{ V}$		74.5		pF
Output Capacitance	C_{OSS}			10.8		
Reverse Transfer Capacitance	C_{RSS}			10.2		
Total Gate Charge	$Q_{G(TOT)}$	$V_{GS} = -4.5\text{ V}, V_{DS} = -10\text{ V}, I_D = -0.45\text{ A}$		0.88		nC
Threshold Gate Charge	$Q_{G(TH)}$			0.07		
Gate-to-Source Charge	Q_{GS}			0.15		
Gate-to-Drain Charge	Q_{GD}			0.28		
SWITCHING CHARACTERISTICS						
Turn-On Delay Time	$t_d(ON)$	$V_{GS} = -4.5\text{ V}, V_{DS} = -10\text{ V}, I_D = -0.45\text{ A}, R_G = 6\ \Omega$		45		ns
Rise Time	t_r			140		
Turn-Off Delay Time	$t_d(OFF)$			1500		
Fall Time	t_f			2100		
BODY DIODE CHARACTERISTICS						
Forward Voltage	V_{SD}	$V_{GS} = 0\text{ V}, I_S = -0.15\text{ A}$	-0.5	-0.65	-1.1	V

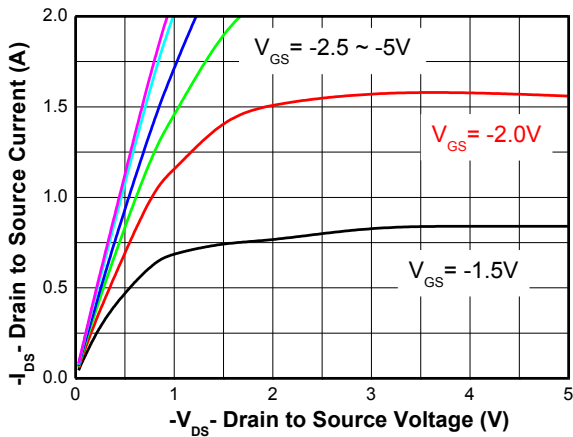
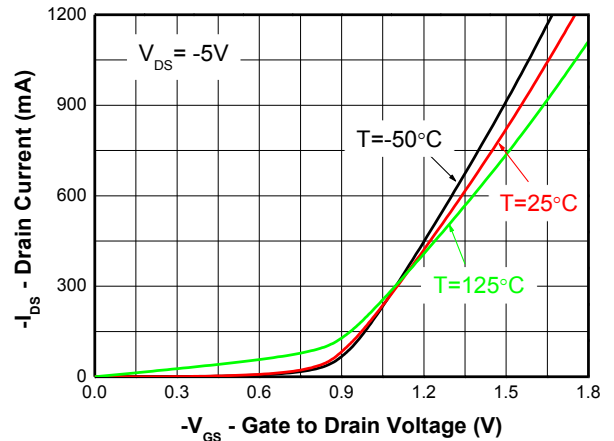
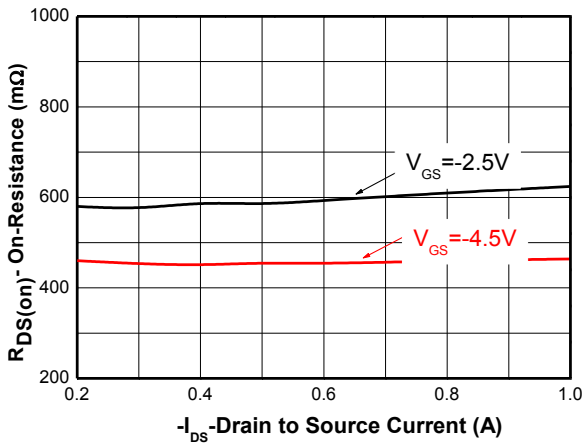
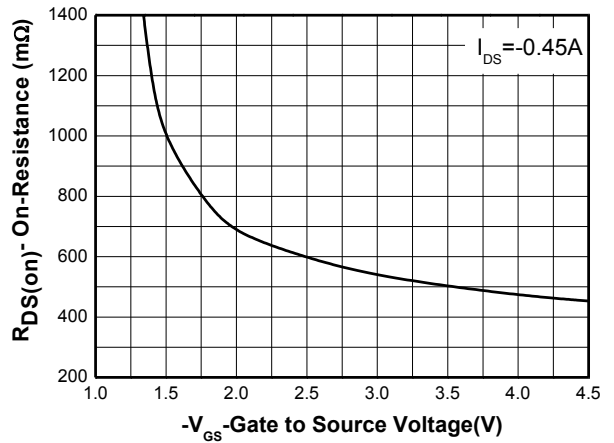
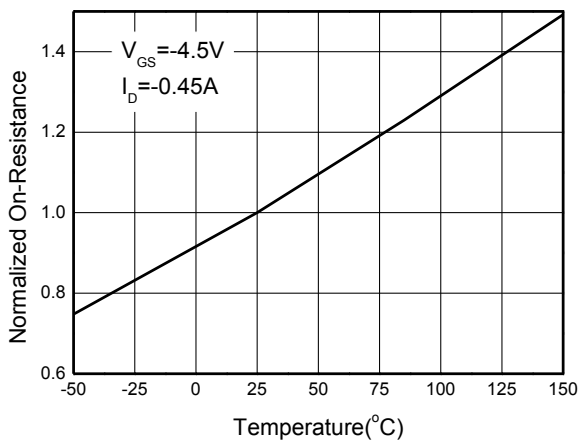
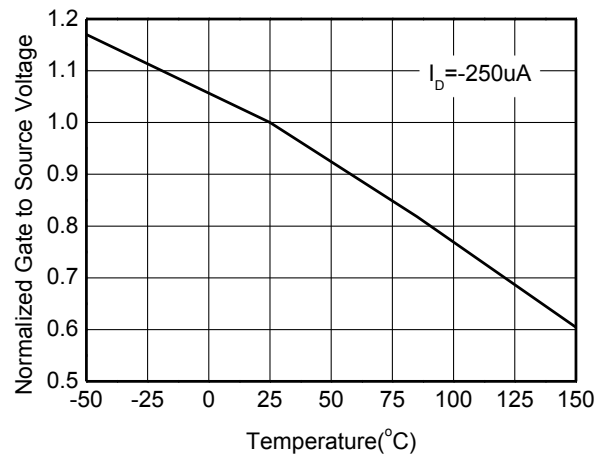
Typical Characteristics (Ta=25°C, unless otherwise noted)

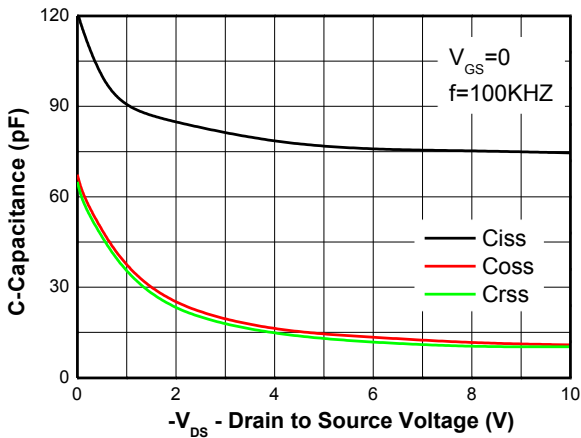
Output characteristics

Transfer characteristics

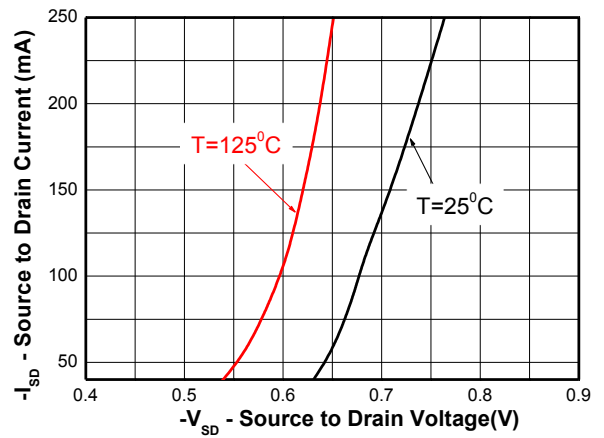
On-Resistance vs. Drain current

On-Resistance vs. Gate-to-Source voltage

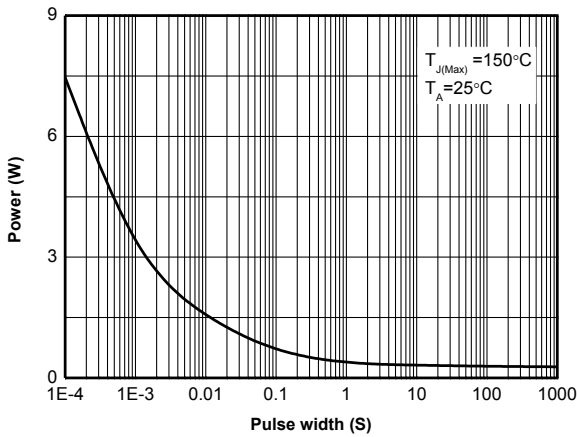
On-Resistance vs. Junction temperature

Threshold voltage vs. Temperature



Capacitance



Body diode forward voltage



Single pulse power

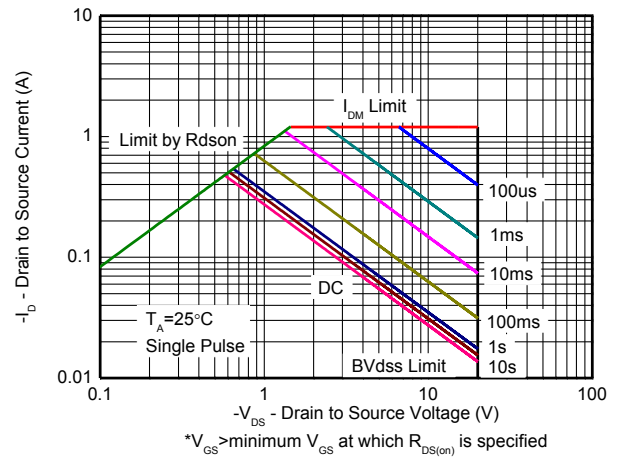

Safe operating power

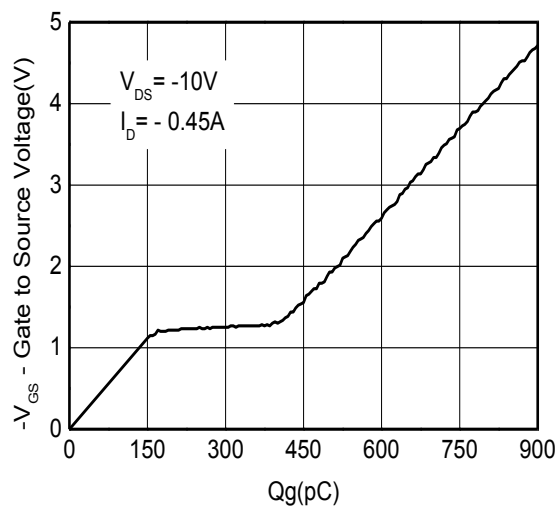

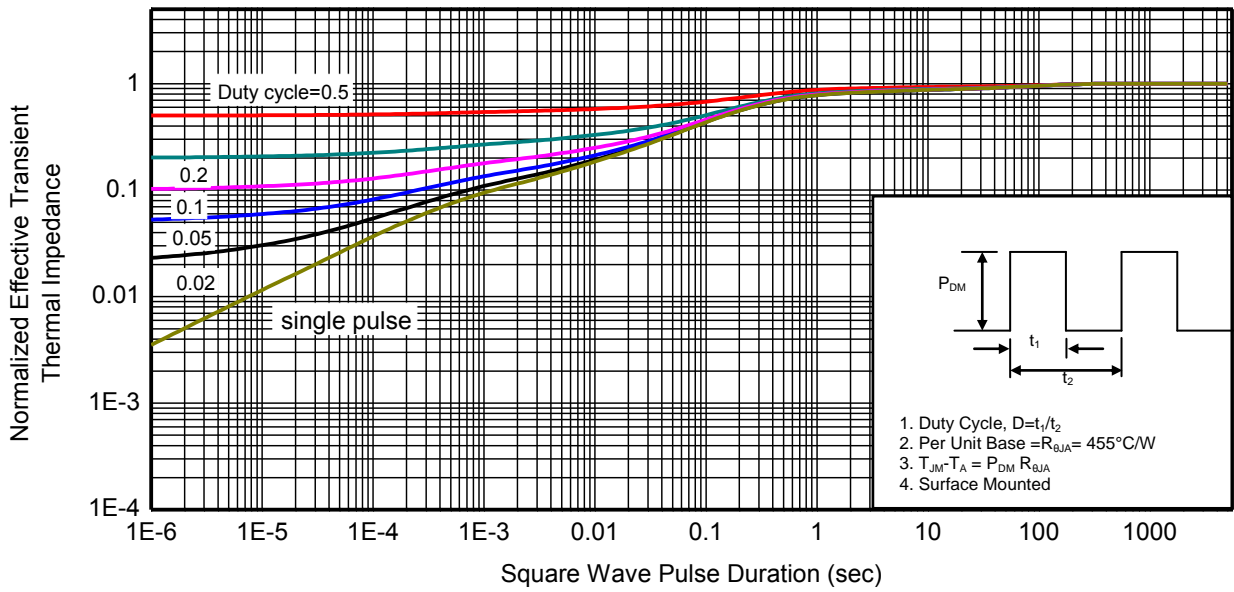

Transient thermal response (Junction-to-Ambient)

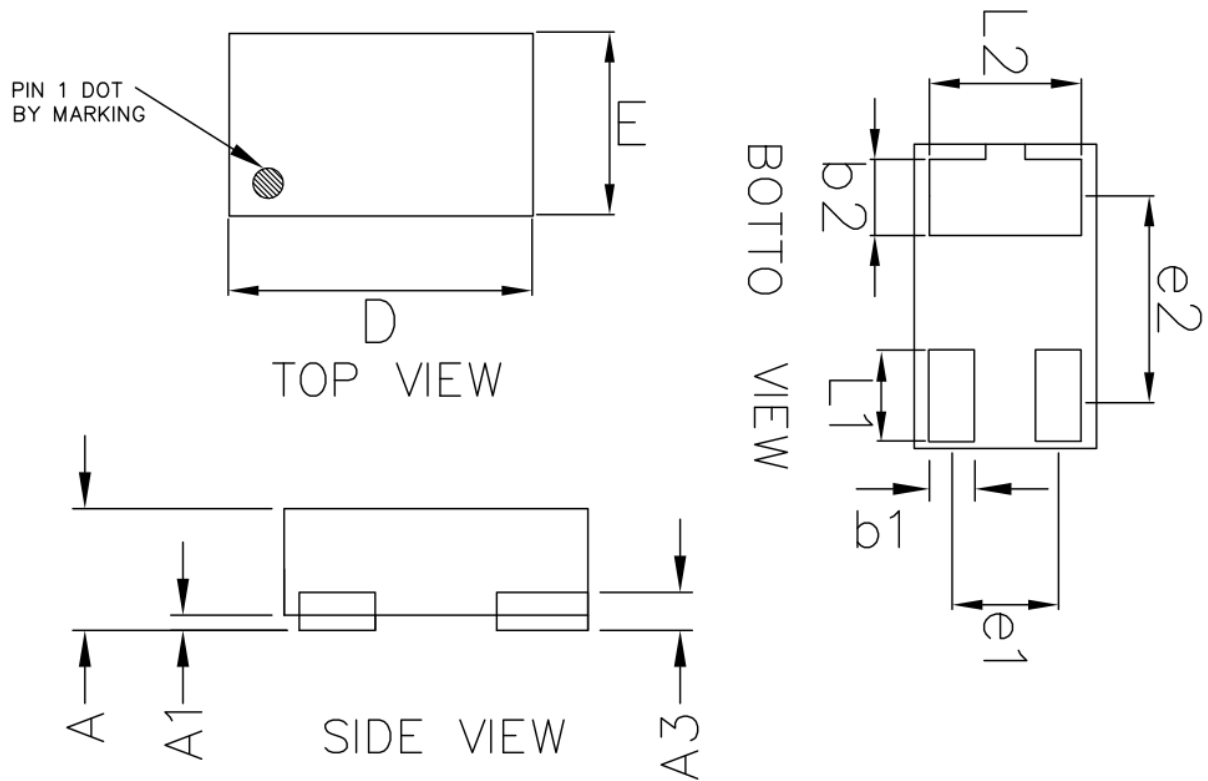
Package outline dimensions
DFN1006-3L

Symbol	Dimensions In Millimeters	
	Min	Max
A	0.36	0.40
A1	-	0.05
A3	0.12 REF	
D	0.95	1.05
E	0.55	0.65
b1	0.10	0.20
b2	0.20	0.30
L1	0.20	0.30
L2	0.40	0.60
e1	0.35 BSC	
e2	0.65 BSC	