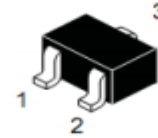
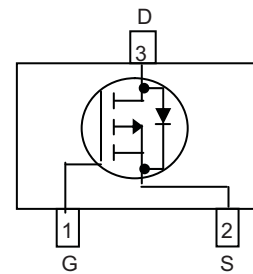
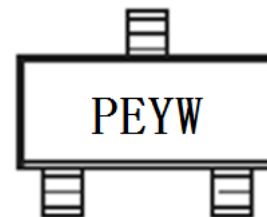

**WPM2087**
**Single P-Channel, -20V, -4.3A, Power MOSFET**
[Http://www.sh-willsemi.com](http://www.sh-willsemi.com)

$V_{DS}$ (V)	Typical $R_{DS(on)}$ (m $\Omega$ )
-20	34 @ $V_{GS}=-4.5V$
	39 @ $V_{GS}=-3.1V$
	45 @ $V_{GS}=-2.5V$

**SOT-23**

**Descriptions**

The WPM2087 is P-Channel enhancement MOS Field Effect Transistor. Uses advanced trench technology and design to provide excellent  $R_{DS(ON)}$  with low gate charge. This device is suitable for use in DC-DC conversion, power switch and charging circuit. Standard Product WPM2087 is Pb-free.

**Pin configuration (Top view)**

**Features**

- Trench Technology
- Supper high density cell design
- Excellent ON resistance
- Extremely Low Threshold Voltage
- Small package SOT-23

PE = Device Code  
 Y = Year  
 W = Week(A~z)

**Applications**

- DC/DC converters
- Power supply converters circuit
- Load/Power Switching for portable device

**Marking**
**Order information**

Device	Package	Shipping
WPM2087-3/TR	SOT-23	3000/Tape&Reel

**Absolute Maximum ratings**

Parameter	Symbol	10 s	Steady State	Unit	
Drain-Source Voltage	$V_{DS}$	-20		V	
Gate-Source Voltage	$V_{GS}$	$\pm 12$			
Continuous Drain Current <sup>a d</sup>	$I_D$	$T_A=25^\circ\text{C}$	-4.3	-3.6	A
		$T_A=70^\circ\text{C}$	-3.4	-2.9	
Maximum Power Dissipation <sup>a d</sup>	$P_D$	$T_A=25^\circ\text{C}$	1.2	0.9	W
		$T_A=70^\circ\text{C}$	0.8	0.6	
Continuous Drain Current <sup>b d</sup>	$I_D$	$T_A=25^\circ\text{C}$	-3.4	-3.1	A
		$T_A=70^\circ\text{C}$	-2.7	-2.5	
Maximum Power Dissipation <sup>b d</sup>	$P_D$	$T_A=25^\circ\text{C}$	0.8	0.7	W
		$T_A=70^\circ\text{C}$	0.5	0.4	
Pulsed Drain Current <sup>c</sup>	$I_{DM}$	-18		A	
Operating Junction Temperature	$T_J$	-55 to 150		$^\circ\text{C}$	
Lead Temperature	$T_L$	260		$^\circ\text{C}$	
Storage Temperature Range	$T_{stg}$	-55 to 150		$^\circ\text{C}$	

**Thermal resistance ratings**

Parameter	Symbol	Typical	Maximum	Unit	
Junction-to-Ambient Thermal Resistance <sup>a</sup>	$R_{\theta JA}$	$t \leq 10 \text{ s}$	84	102	$^\circ\text{C/W}$
		Steady State	120	145	
Junction-to-Ambient Thermal Resistance <sup>b</sup>	$R_{\theta JA}$	$t \leq 10 \text{ s}$	130	160	
		Steady State	145	190	
Junction-to-Case Thermal Resistance	$R_{\theta JC}$	60	75		

- a. Surface mounted on FR4 Board using 1 in sq pad size, 1oz Cu.
- b. Surface mounted on FR4 board using the minimum recommended pad size, 1oz Cu.
- c. Repetitive rating, pulse width limited by junction temperature,  $t_p=10\mu\text{s}$ , Duty Cycle=1%.
- d. Repetitive rating, pulse width limited by junction temperature  $T_J(\text{MAX})=150^\circ\text{C}$ .

**Electronics Characteristics (Ta=25°C, unless otherwise noted)**

Parameter	Symbol	Test Conditions	Min	Typ	Max	Unit
<b>OFF CHARACTERISTICS</b>						
Drain-to-Source Breakdown Voltage	BV <sub>DSS</sub>	V <sub>GS</sub> = 0 V, I <sub>D</sub> = -250uA	-20			V
Zero Gate Voltage Drain Current	I <sub>DSS</sub>	V <sub>DS</sub> = -16V, V <sub>GS</sub> = 0V			-1	uA
Gate-to-source Leakage Current	I <sub>GSS</sub>	V <sub>DS</sub> = 0 V, V <sub>GS</sub> = ±12V			±100	nA
<b>ON CHARACTERISTICS</b>						
Gate Threshold Voltage	V <sub>GS(TH)</sub>	V <sub>GS</sub> = V <sub>DS</sub> , I <sub>D</sub> = -250uA	-0.4	-0.75	-1.0	V
Drain-to-source On-resistance	R <sub>DS(on)</sub>	V <sub>GS</sub> = -4.5V, I <sub>D</sub> = -5A		34	45	mΩ
		V <sub>GS</sub> = -3.1V, I <sub>D</sub> = -2.5A		39	55	
		V <sub>GS</sub> = -2.5V, I <sub>D</sub> = -2.0A		45	59	
Forward Transconductance	g <sub>FS</sub>	V <sub>DS</sub> = -5 V, I <sub>D</sub> = -3.0A		4	9	S
<b>CHARGES, CAPACITANCES AND GATE RESISTANCE</b>						
Input Capacitance	C <sub>ISS</sub>	V <sub>GS</sub> = 0 V, f = 1.0MHz, V <sub>DS</sub> = -10 V		1182		pF
Output Capacitance	C <sub>OSS</sub>			126		
Reverse Transfer Capacitance	C <sub>RSS</sub>			108		
Total Gate Charge	Q <sub>G(TOT)</sub>	V <sub>GS</sub> = -4.5 V, V <sub>DS</sub> = -10 V, I <sub>D</sub> = -5.0 A		12		nC
Threshold Gate Charge	Q <sub>G(TH)</sub>			0.85		
Gate-to-Source Charge	Q <sub>GS</sub>			2.5		
Gate-to-Drain Charge	Q <sub>GD</sub>			2.8		
<b>SWITCHING CHARACTERISTICS</b>						
Turn-On Delay Time	t <sub>d(ON)</sub>	V <sub>GS</sub> = -10 V, V <sub>DS</sub> = -15 V, I <sub>D</sub> = -5A, R <sub>G</sub> = 6Ω		7.8		ns
Rise Time	t <sub>r</sub>			6.4		
Turn-Off Delay Time	t <sub>d(OFF)</sub>			80		
Fall Time	t <sub>f</sub>			18		
<b>BODY DIODE CHARACTERISTICS</b>						
Forward Voltage	V <sub>SD</sub>	V <sub>GS</sub> = 0 V, I <sub>S</sub> = -1A	-0.6	-0.75	-1.2	V

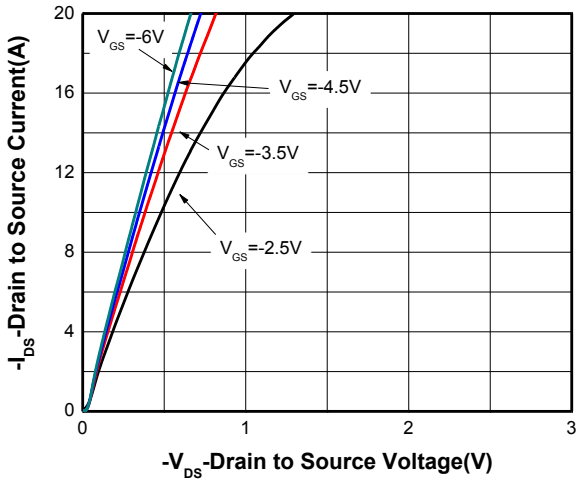
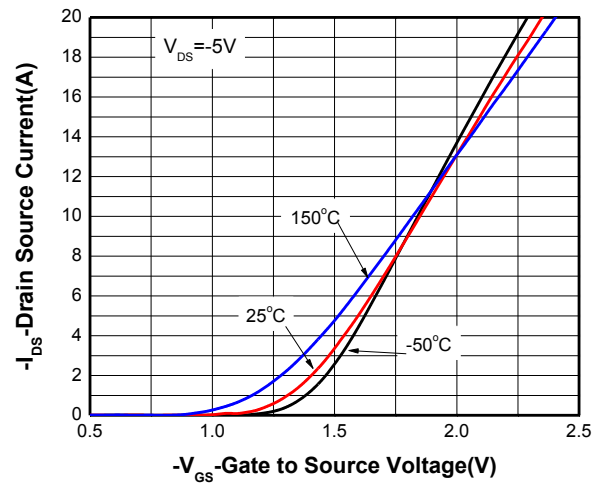
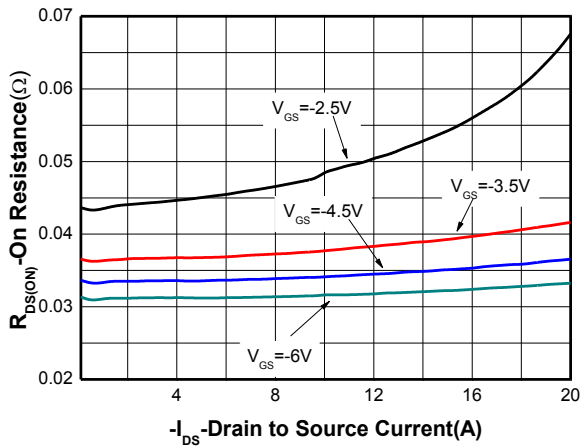
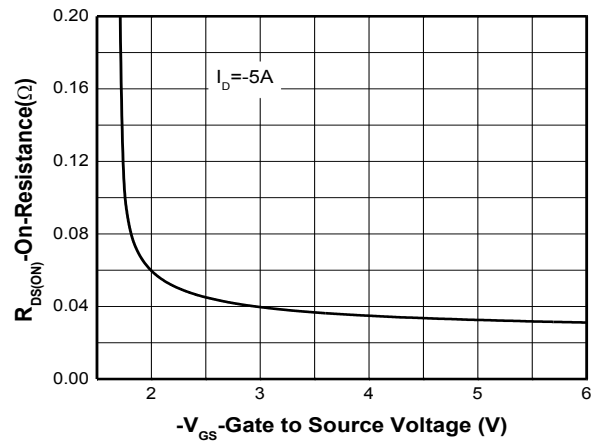
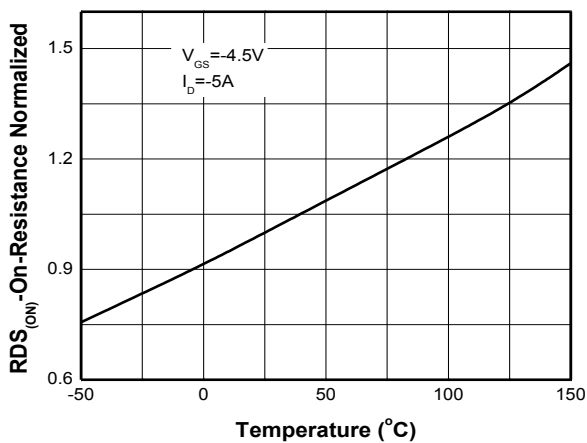
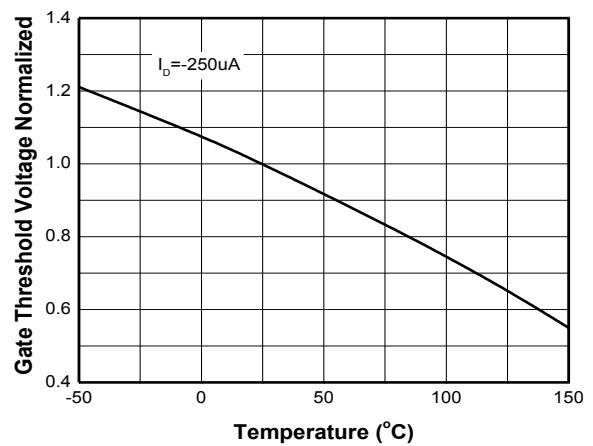
**Typical Characteristics (Ta=25°C, unless otherwise noted)**

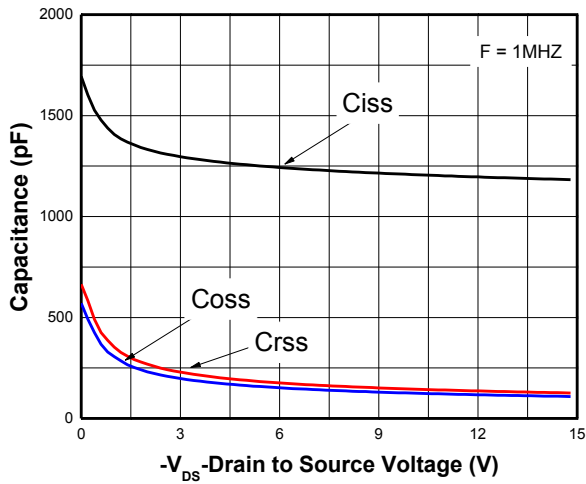
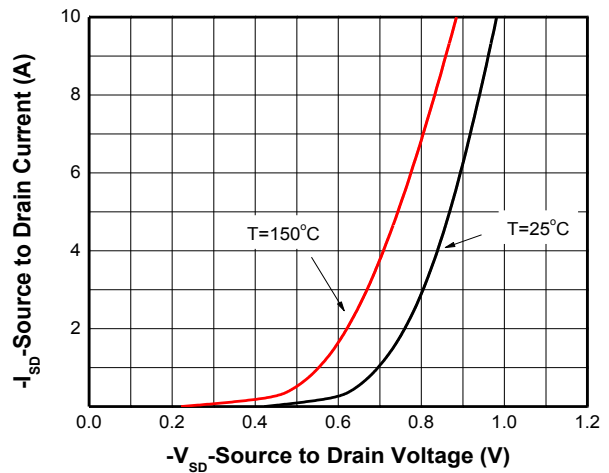
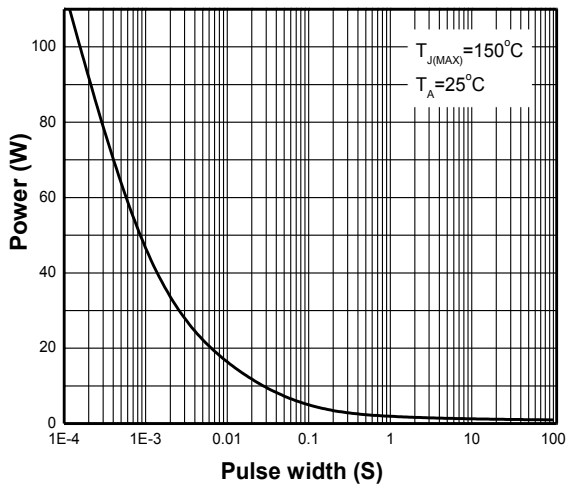
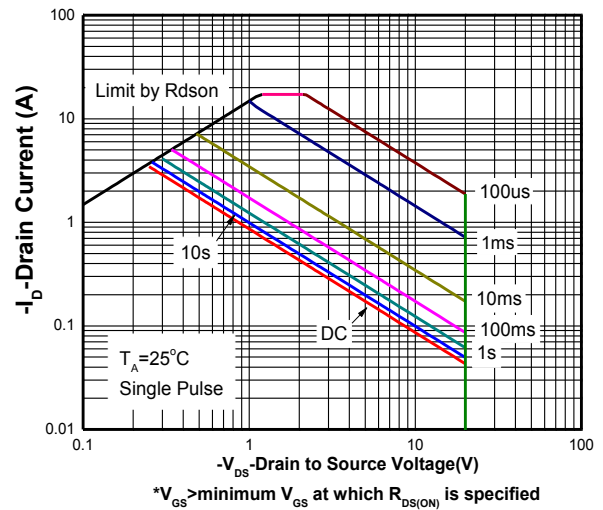
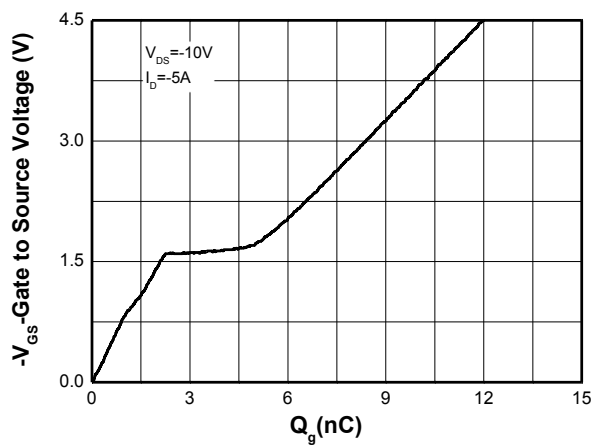
**Output characteristics**

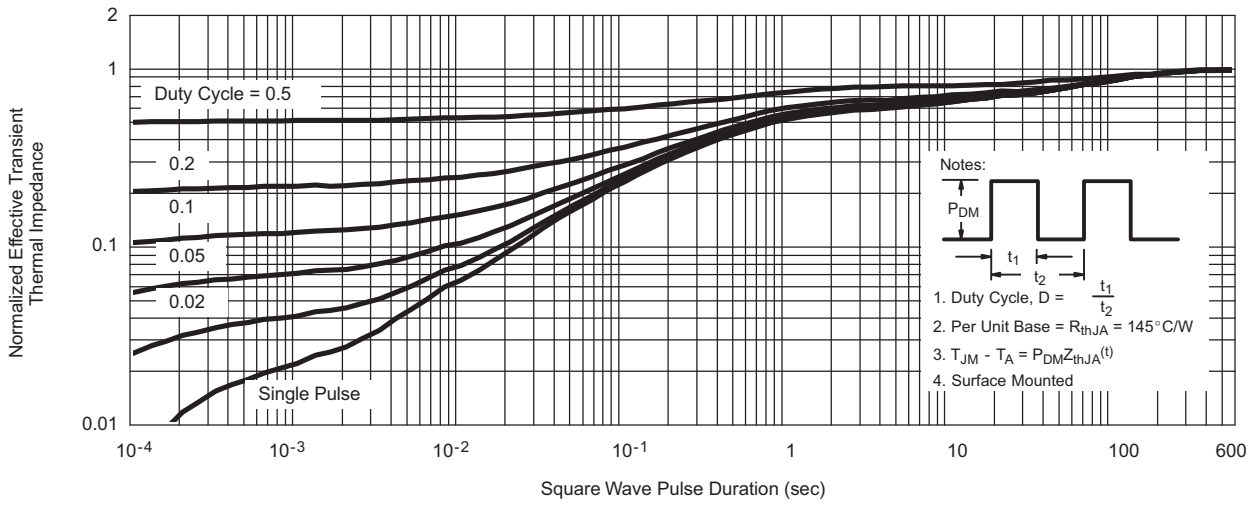
**Transfer characteristics**

**On-Resistance vs. Drain current**

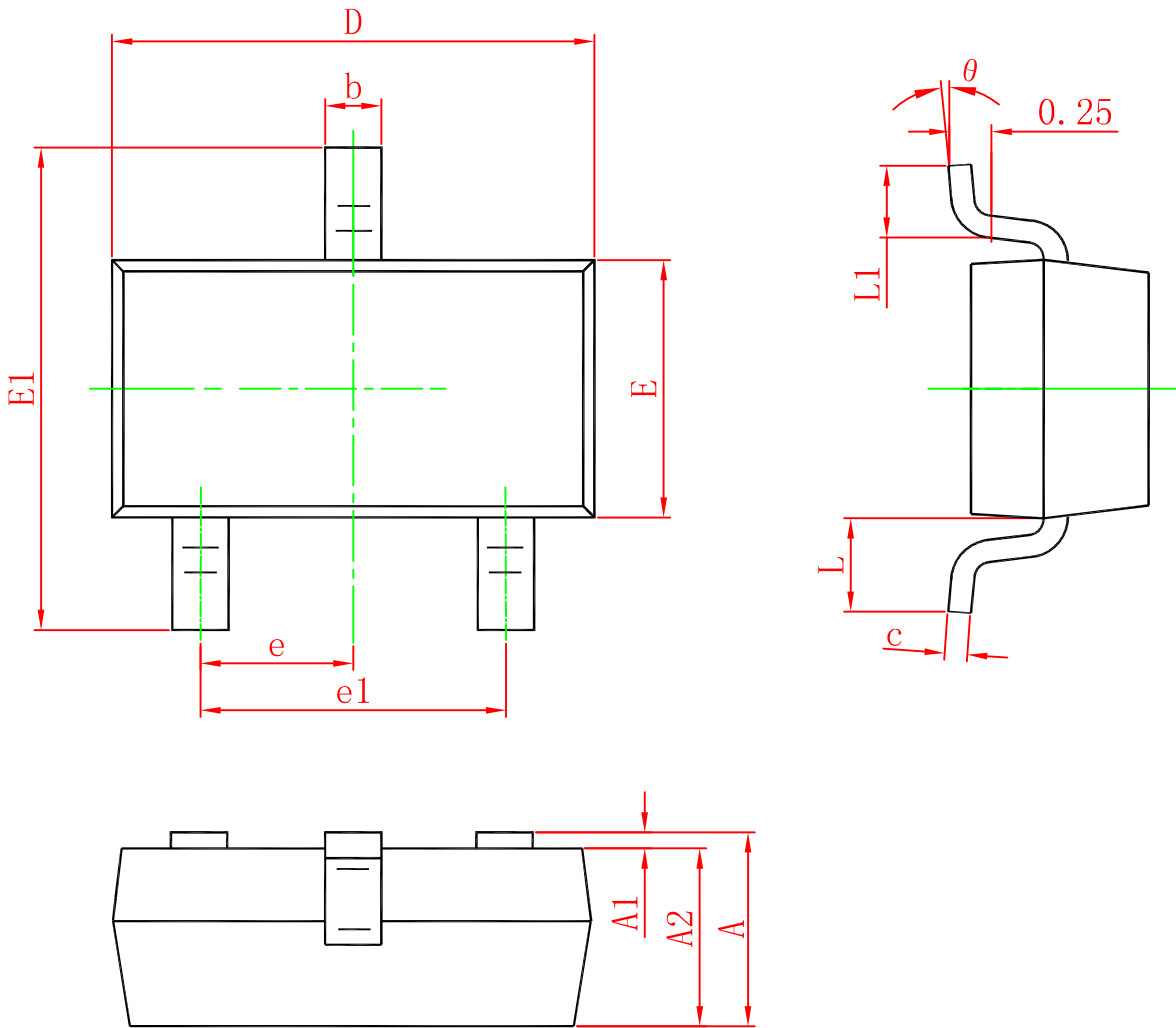
**On-Resistance vs. Gate-to-source voltage**

**On-Resistance vs. Junction temperature**

**Threshold voltage vs. Temperature**

**Capacitance**

**Body diode forward voltage**

**Single pulse power**

**Safe operating power**

**Gate Charge Characteristics**



**Transient thermal response (Junction-to-Ambient)**

**Package outline dimensions**
**SOT-23**

Symbol	Dimensions In Millimeters	
	Min.	Max.
A	0.900	1.150
A1	0.000	0.100
A2	0.900	1.050
b	0.300	0.500
c	0.080	0.150
D	2.800	3.000
E	1.200	1.400
E1	2.250	2.550
e	0.950 (Typ.)	
e1	1.800	2.000
L	0.550 (Typ.)	
L1	0.300	0.500
$\theta$	0°	8°