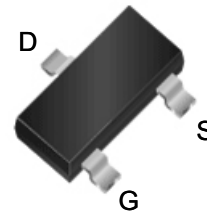
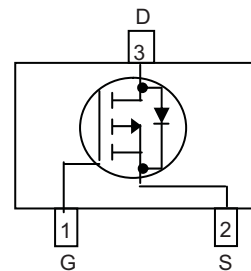

WPM3022
Single P-Channel, -30V, -3.1A, Power MOSFET
[Http://www.sh-willsemi.com](http://www.sh-willsemi.com)

V_{DS} (V)	Typical $R_{DS(on)}$ (m Ω)
-30	56 @ $V_{GS}=-10V$
	77 @ $V_{GS}=-4.5V$

SOT-23

Pin configuration (Top view)
Descriptions

The WPM3022 is P-Channel enhancement MOS Field Effect Transistor. Uses advanced trench technology and design to provide excellent $R_{DS(ON)}$ with low gate charge. This device is suitable for use in DC-DC conversion, power switch and charging circuit. Standard Product WPM3022 is Pb-free.

Features

- Trench Technology
- Supper high density cell design
- Excellent ON resistance
- Extremely Low Threshold Voltage
- Small package SOT-23

Applications

- DC/DC converters
- Power supply converters circuit
- Load/Power Switching for portable device

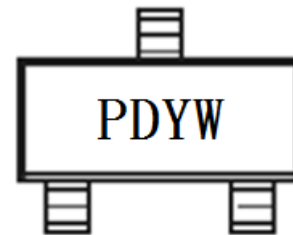

PD = Device Code
 Y = Year
 W = Week(A~z)

Marking
Order information

Device	Package	Shipping
WPM3022-3/TR	SOT-23	3000/Tape&Reel

Absolute Maximum ratings

Parameter	Symbol	10 s	Steady State	Unit	
Drain-Source Voltage	V_{DS}	-30		V	
Gate-Source Voltage	V_{GS}	±20			
Continuous Drain Current ^{a d}	I_D	$T_A=25^{\circ}C$	-3.1	-2.9	A
		$T_A=70^{\circ}C$	-2.5	-2.3	
Maximum Power Dissipation ^{a d}	P_D	$T_A=25^{\circ}C$	0.96	0.80	W
		$T_A=70^{\circ}C$	0.62	0.52	
Continuous Drain Current ^{b d}	I_D	$T_A=25^{\circ}C$	-2.8	-2.6	A
		$T_A=70^{\circ}C$	-2.2	-2.0	
Maximum Power Dissipation ^{b d}	P_D	$T_A=25^{\circ}C$	0.78	0.66	W
		$T_A=70^{\circ}C$	0.50	0.42	
Pulsed Drain Current ^c	I_{DM}	-15		A	
Operating Junction Temperature	T_J	-55 to 150		°C	
Lead Temperature	T_L	260		°C	
Storage Temperature Range	T_{stg}	-55 to 150		°C	

Thermal resistance ratings

Single Operation					
Parameter		Symbol	Typical	Maximum	Unit
Junction-to-Ambient Thermal Resistance ^a	$t \leq 10$ s	$R_{\theta JA}$	105	130	°C/W
	Steady State		120	155	
Junction-to-Ambient Thermal Resistance ^b	$t \leq 10$ s	$R_{\theta JA}$	130	160	
	Steady State		145	190	
Junction-to-Case Thermal Resistance	Steady State	$R_{\theta JC}$	40	60	

a Surface mounted on FR4 Board using 1 square inch pad size, 1oz copper

b Surface mounted on FR4 board using minimum pad size, 1oz copper

c Repetitive rating, pulse width limited by junction temperature, $t_p=10\mu s$, Duty Cycle=1%

d Repetitive rating, pulse width limited by junction temperature $T_J=150^{\circ}C$.

Electronics Characteristics (Ta=25°C, unless otherwise noted)

Parameter	Symbol	Test Conditions	Min	Typ	Max	Unit
OFF CHARACTERISTICS						
Drain-to-Source Breakdown Voltage	BV_{DSS}	$V_{GS} = 0\text{ V}, I_D = -250\mu\text{A}$	-30			V
Zero Gate Voltage Drain Current	I_{DSS}	$V_{DS} = -24\text{ V}, V_{GS} = 0\text{ V}$			-1	μA
Gate-to-source Leakage Current	I_{GSS}	$V_{DS} = 0\text{ V}, V_{GS} = \pm 20\text{ V}$			± 100	nA
ON CHARACTERISTICS						
Gate Threshold Voltage	$V_{GS(TH)}$	$V_{GS} = V_{DS}, I_D = -250\mu\text{A}$	-1.5	-1.9	-2.5	V
Drain-to-source On-resistance	$R_{DS(on)}$	$V_{GS} = -10\text{ V}, I_D = -3.1\text{ A}$		56	68	m Ω
		$V_{GS} = -4.5\text{ V}, I_D = -3.0\text{ A}$		77	95	
Forward Transconductance	g_{FS}	$V_{DS} = -5\text{ V}, I_D = -3\text{ A}$		6	16	S
CHARGES, CAPACITANCES AND GATE RESISTANCE						
Input Capacitance	C_{ISS}	$V_{GS} = 0\text{ V}, f = 1.0\text{ MHz}, V_{DS} = -20\text{ V}$		599		pF
Output Capacitance	C_{OSS}			59		
Reverse Transfer Capacitance	C_{RSS}			41		
Total Gate Charge	$Q_{G(TOT)}$	$V_{GS} = -10\text{ V}, V_{DS} = -15\text{ V}, I_D = -3.1\text{ A}$		9.7		nC
Threshold Gate Charge	$Q_{G(TH)}$			1.3		
Gate-to-Source Charge	Q_{GS}			2.0		
Gate-to-Drain Charge	Q_{GD}			1.8		
SWITCHING CHARACTERISTICS						
Turn-On Delay Time	$t_d(ON)$	$V_{GS} = -10\text{ V}, V_{DS} = -15\text{ V}, I_D = -3\text{ A}, R_G = 15\Omega$		9.6		ns
Rise Time	t_r			3.6		
Turn-Off Delay Time	$t_d(OFF)$			36.8		
Fall Time	t_f			7.2		
BODY DIODE CHARACTERISTICS						
Forward Voltage	V_{SD}	$V_{GS} = 0\text{ V}, I_S = -3.1\text{ A}$		-0.8	-1.5	V

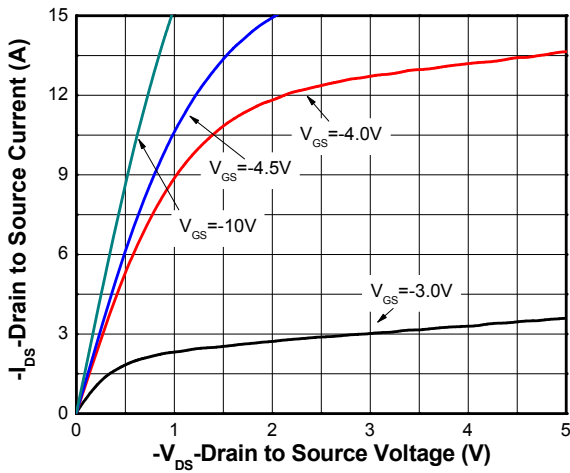
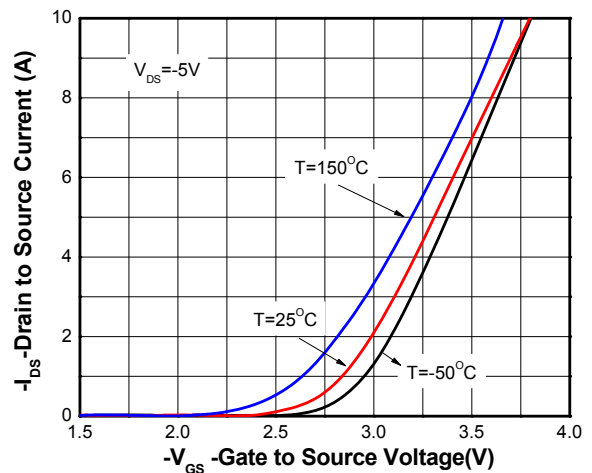
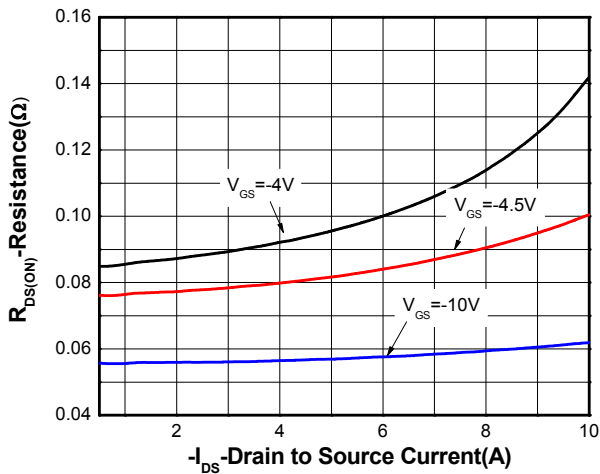
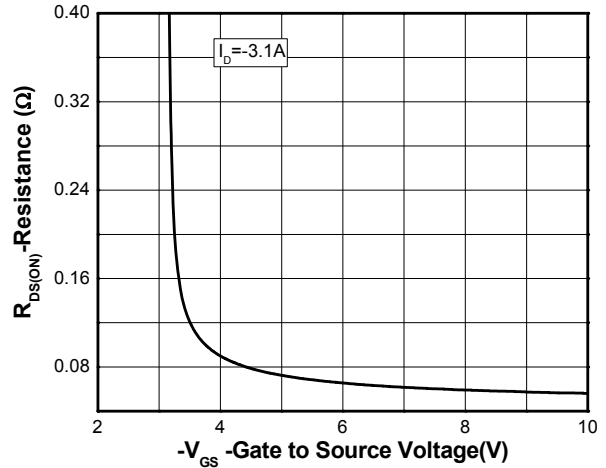
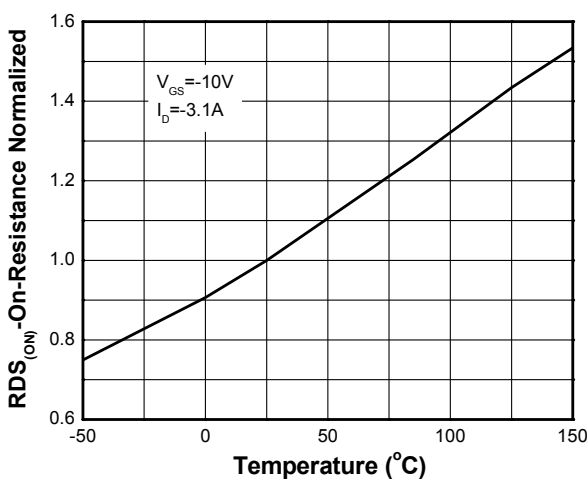
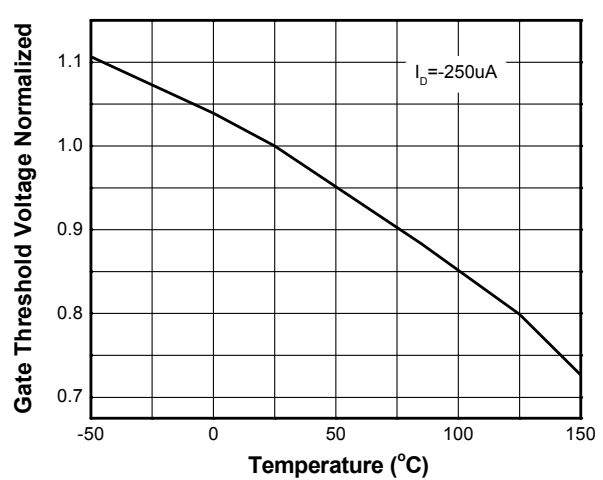
Typical Characteristics (Ta=25°C, unless otherwise noted)

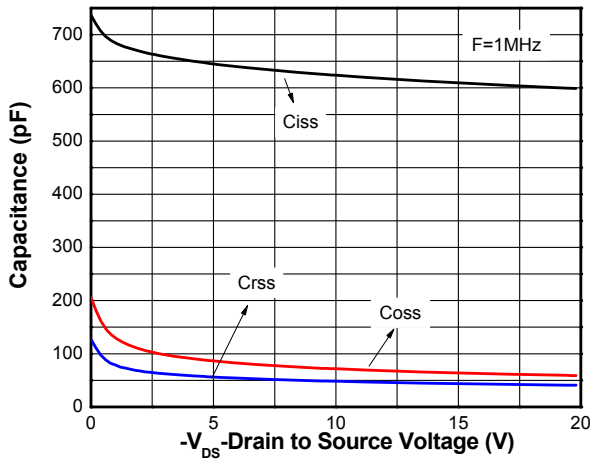
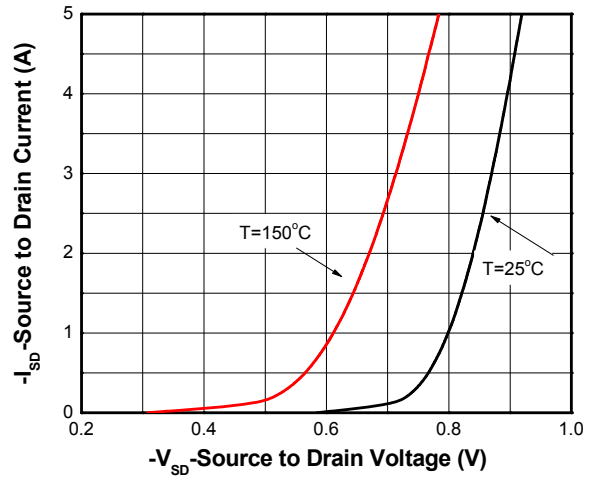
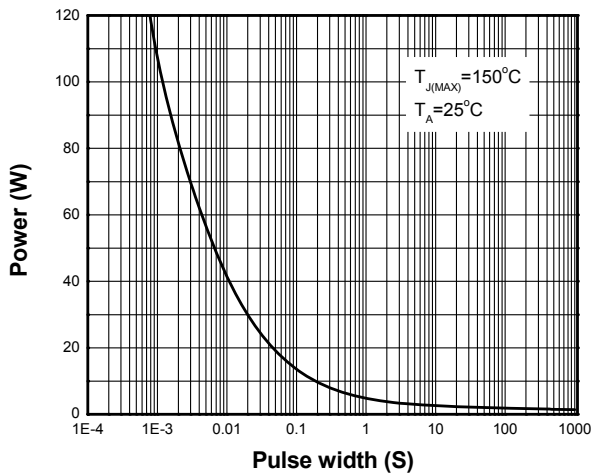
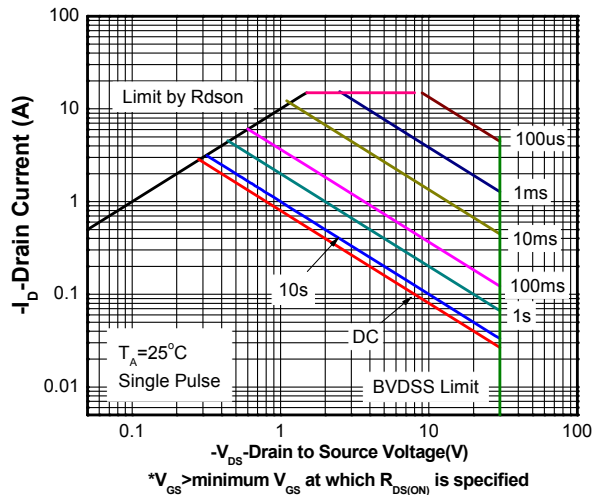
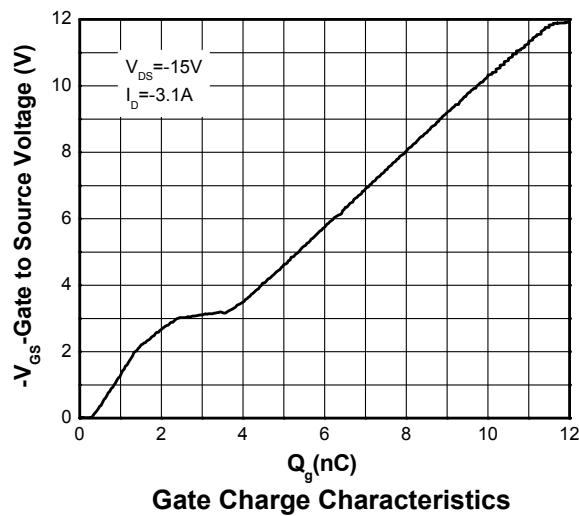
Output characteristics

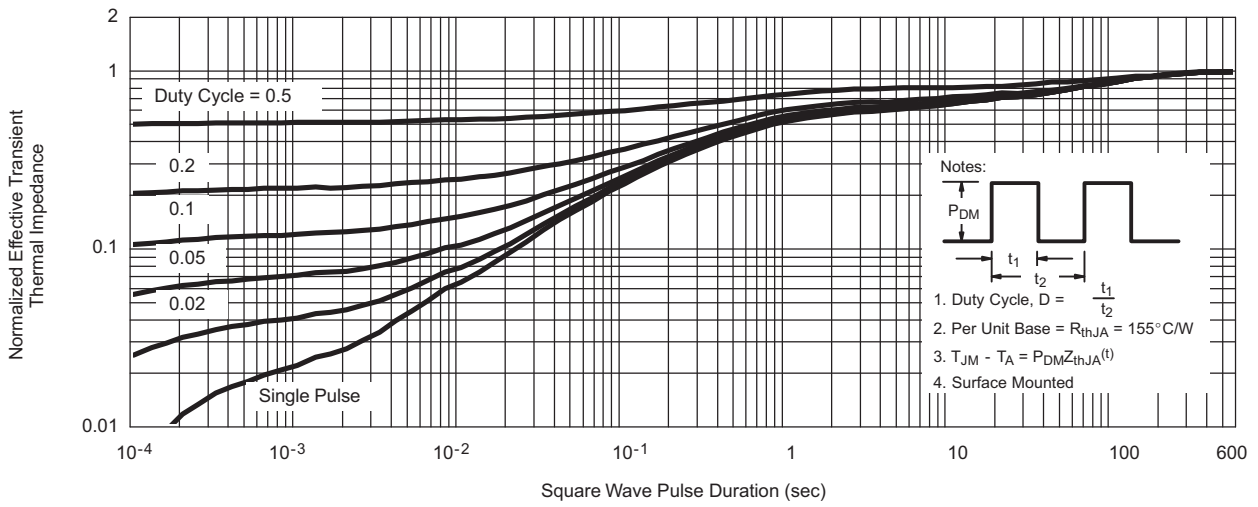
Transfer characteristics

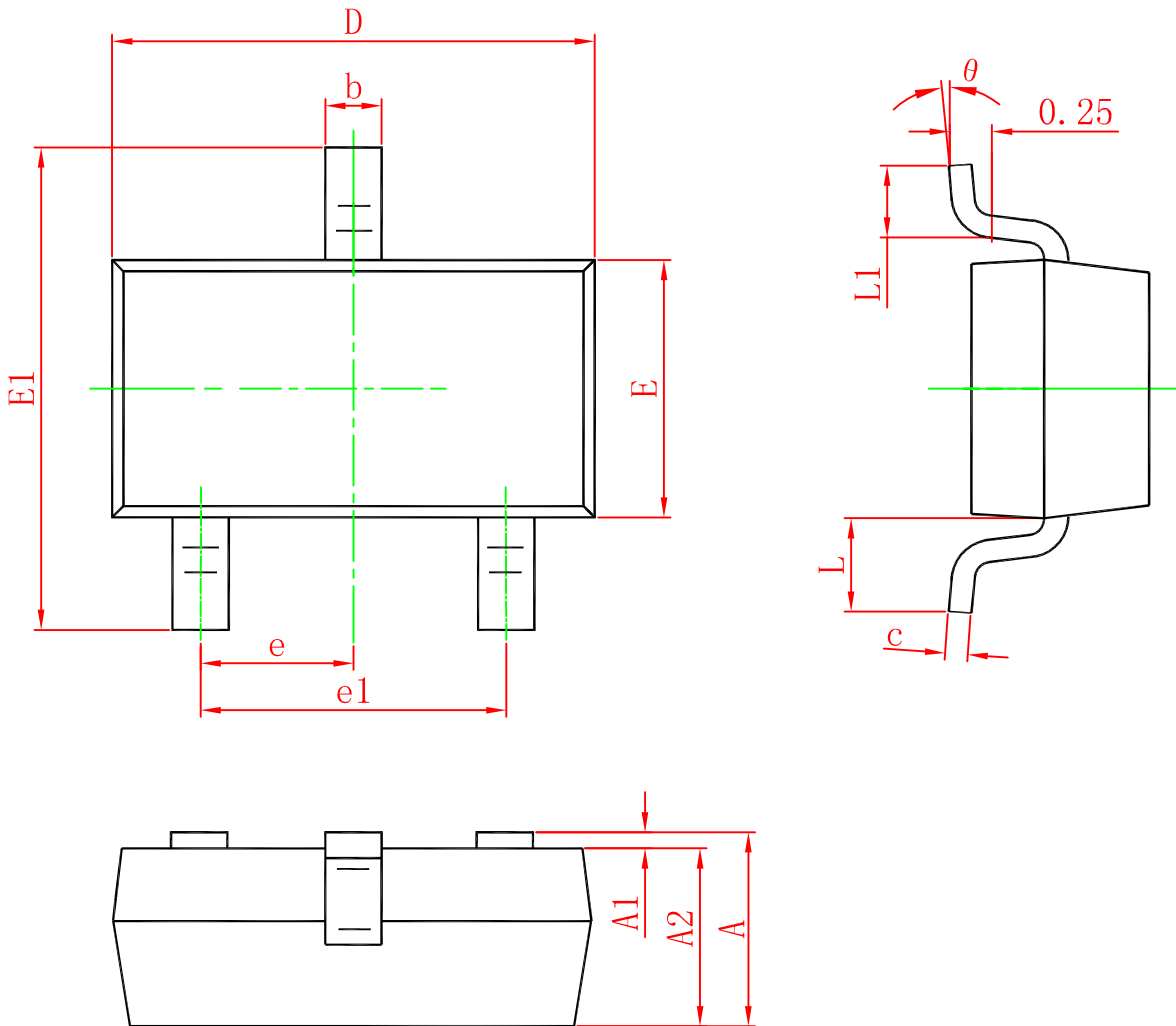
On-Resistance vs. Drain current

On-Resistance vs. Gate-to-source voltage

On-Resistance vs. Junction temperature

Threshold voltage vs. Temperature

Capacitance

Body diode forward voltage

Single pulse power

Safe operating power

Gate Charge Characteristics

Transient thermal response (Junction-to-Ambient)

Package outline dimensions
SOT-23

Symbol	Dimensions In Millimeters	
	Min.	Max.
A	0.900	1.150
A1	0.000	0.100
A2	0.900	1.050
b	0.300	0.500
c	0.080	0.150
D	2.800	3.000
E	1.200	1.400
E1	2.250	2.550
e	0.950 (Typ.)	
e1	1.800	2.000
L	0.550 (Typ.)	
L1	0.300	0.500
θ	0°	8°