

## Features

- 600 watts Peak Pulse Power (10/1000  $\mu$ s)
- Unidirectional and Bidirectional Protection
- Fast Response Time : Typically < 1ns
- Excellent Clamping Capability
- Glass Passivated Junction
- Built-in Strain relief
- Low inductance
- Low profile package
- High temperature solder:260°C/10 seconds at terminal

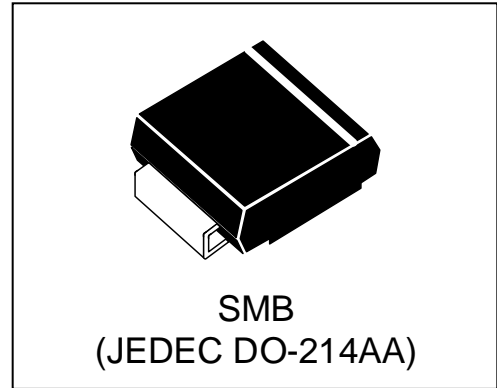

## Mechanical Characteristics

- JEDEC DO-214AA package
- Molding compound flammability rating:  
UL 94V-0
- Marking : Marking Code
- Packaging : Tape and Reel per EIA 481
- RoHS &UL497B Compliant

## Applications

- I/O Interfaces
- Power lines
- Automotive and Telecommunication
- Computers & Consumer Electronics
- Industrial Electronics

Absolute Maximum Rating			
Rating	Symbol	Value	Units
Peak Pulse Power (tp =10/1000 $\mu$ s) (see Note1,2& 3)	P <sub>PPM</sub>	600	Watts
Peak pulse current (10/1000 $\mu$ s) (see Note2&3)	I <sub>PPM</sub>	See Electrical Characteristics	A
Peak Forward surge current (see Note4&5)	I <sub>FSM</sub>	100	A
Power Dissipation on infinite heat sink T <sub>A</sub> = 50 °C (Fig5)	P <sub>D</sub>	5.0	W
Operating Junction Temperature range	T <sub>J</sub>	-65 to + 150	°C
Storage Temperature range	T <sub>STG</sub>	-65 to + 150	°C

**Note1:** Peak Pulse Power Rating as Pulse Width per Fig1.

**Note2:** Peak Pulse Power or Current Derated above TA=25°C Per Fig. 2 and Non-Repetitive Current Pulse, Per Fig.3.

**Note3:** Mounted on 5.0x5.0mm<sup>2</sup> copper pad to each terminal.

**Note4:** 8.3ms Single Half Sine Wave or Equivalent Square Wave.

**Note5:** Maximum Forward Surge Current only for Unidirectional Device per Fig6.

## Electrical Characteristics

Part Number		Reverse Stand off Voltage $V_{RWM}$ (Volts)	Breakdown Voltage $V_{BR}(\text{Volts})@I_T$		Test Current $I_T$ (mA)	Maximum Clamping Voltage $V_c@I_{PP}$ (Volts)	Maximum Peak Pulse Current $I_{pp}$ (Amps)	Maximum Reverse Leakage $I_R@V_{RWM}$ ( $\mu$ A)
			MIN	MAX				
UNI-POLAR	BI-POLAR							
WS5.0P6SMB	WS5.0P6SMB-B	5.0	6.40	7.07	10	9.2	65.2	800
WS6.0P6SMB	WS6.0P6SMB-B	6.0	6.67	7.37	10	10.3	58.3	800
WS6.5P6SMB	WS6.5P6SMB-B	6.5	7.22	7.98	10	11.2	53.6	500
WS7.0P6SMB	WS7.0P6SMB-B	7.0	7.78	8.60	10	12.0	50.0	200
WS7.5P6SMB	WS7.5P6SMB-B	7.5	8.33	9.21	1	12.9	46.5	100
WS8.0P6SMB	WS8.0P6SMB-B	8.0	8.89	9.83	1	13.6	44.1	50
WS8.5P6SMB	WS8.5P6SMB-B	8.5	9.44	10.40	1	14.4	41.7	20
WS9.0P6SMB	WS9.0P6SMB-B	9.0	10.00	11.10	1	15.4	39.0	10
WS10P6SMB	WS10P6SMB-B	10	11.10	12.30	1	17.0	35.3	5
WS11P6SMB	WS11P6SMB-B	11	12.20	13.50	1	18.2	33.0	5
WS12P6SMB	WS12P6SMB-B	12	13.30	14.7	1	19.9	30.2	5
WS13P6SMB	WS13P6SMB-B	13	14.40	15.90	1	21.5	27.9	1
WS14P6SMB	WS14P6SMB-B	14	15.60	17.20	1	23.2	25.9	1
WS15P6SMB	WS15P6SMB-B	15	16.70	18.50	1	24.4	24.6	1
WS16P6SMB	WS16P6SMB-B	16	17.80	19.70	1	26.0	23.1	1
WS17P6SMB	WS17P6SMB-B	17	18.90	20.90	1	27.6	21.7	1
WS18P6SMB	WS18P6SMB-B	18	20.00	22.10	1	29.2	20.5	1
WS20P6SMB	WS20P6SMB-B	20	22.20	24.50	1	32.4	18.5	1
WS22P6SMB	WS22P6SMB-B	22	24.40	26.90	1	35.5	16.9	1
WS24P6SMB	WS24P6SMB-B	24	26.70	29.50	1	38.9	15.4	1
WS26P6SMB	WS26P6SMB-B	26	28.90	31.90	1	42.1	14.3	1
WS28P6SMB	WS28P6SMB-B	28	31.10	34.40	1	45.4	13.2	1
WS30P6SMB	WS30P6SMB-B	30	33.30	36.80	1	48.4	12.4	1
WS33P6SMB	WS33P6SMB-B	33	36.70	40.60	1	53.3	11.3	1
WS36P6SMB	WS36P6SMB-B	36	40.00	44.20	1	58.1	10.3	1
WS40P6SMB	WS40P6SMB-B	40	44.40	49.10	1	64.5	9.3	1
WS43P6SMB	WS43P6SMB-B	43	47.80	52.80	1	69.4	8.6	1
WS45P6SMB	WS45P6SMB-B	45	50.00	55.30	1	72.7	8.3	1

## Electrical Characteristics (Cont.)

Part Number		Reverse Stand off Voltage $V_{RWM}$ (Volts)	Breakdown Voltage $V_{BR}(\text{Volts})@I_T$		Test Current $I_T$ (mA)	Maximum Clamping Voltage $V_C@I_{PP}$ (Volts)	Maximum Peak Pulse Current $I_{PP}$ (Amps)	Maximum Reverse Leakage $I_R@V_{RWM}$ ( $\mu\text{A}$ )
			MIN	MAX				
UNI-POLAR	BI-POLAR							
WS48P6SMB	WS48P6SMB-B	48	53.30	58.90	1	77.4	7.8	1
WS51P6SMB	WS51P6SMB-B	51	56.70	62.70	1	82.4	7.3	1
WS54P6SMB	WS54P6SMB-B	54	60.00	66.30	1	87.1	6.9	1
WS58P6SMB	WS58P6SMB-B	58	64.40	71.20	1	93.6	6.4	1
WS60P6SMB	WS60P6SMB-B	60	66.70	73.70	1	96.8	6.2	1
WS64P6SMB	WS64P6SMB-B	64	71.10	78.60	1	103	5.8	1
WS70P6SMB	WS70P6SMB-B	70	77.80	86.00	1	113	5.3	1
WS75P6SMB	WS75P6SMB-B	75	83.30	92.10	1	121	5.0	1
WS78P6SMB	WS78P6SMB-B	78	86.70	95.80	1	126	4.8	1
WS85P6SMB	WS85P6SMB-B	85	94.40	104	1	137	4.4	1
WS90P6SMB	WS90P6SMB-B	90	100	111	1	146	4.1	1
WS100P6SMB	WS100P6SMB-B	100	111	123	1	162	3.7	1
WS110P6SMB	WS110P6SMB-B	110	122	135	1	177	3.4	1
WS120P6SMB	WS120P6SMB-B	120	133	147	1	193	3.1	1
WS130P6SMB	WS130P6SMB-B	130	144	159	1	209	2.9	1
WS150P6SMB	WS150P6SMB-B	150	167	185	1	243	2.5	1
WS160P6SMB	WS160P6SMB-B	160	178	197	1	259	2.3	1
WS170P6SMB	WS170P6SMB-B	170	189	209	1	275	2.2	1
WS180P6SMB	WS180P6SMB-B	180	201	222	1	292	2.1	1
WS200P6SMB	WS200P6SMB-B	200	224	247	1	324	1.9	1
WS220P6SMB	WS220P6SMB-B	220	246	272	1	356	1.7	1
WS250P6SMB	WS250P6SMB-B	250	279	309	1	405	1.5	1
WS300P6SMB	WS300P6SMB-B	300	335	371	1	486	1.3	1
WS350P6SMB	WS350P6SMB-B	350	391	432	1	567	1.1	1
WS400P6SMB	WS400P6SMB-B	400	447	494	1	648	0.9	1
WS440P6SMB	WS440P6SMB-B	440	492	543	1	713	0.9	1

Typical Characteristics

Figure 1: Peak Pulse Power Rating Curve

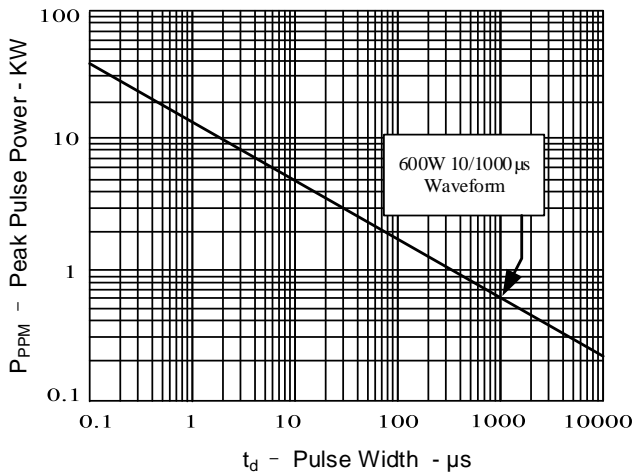

Figure 2: Pulse Derating Curve

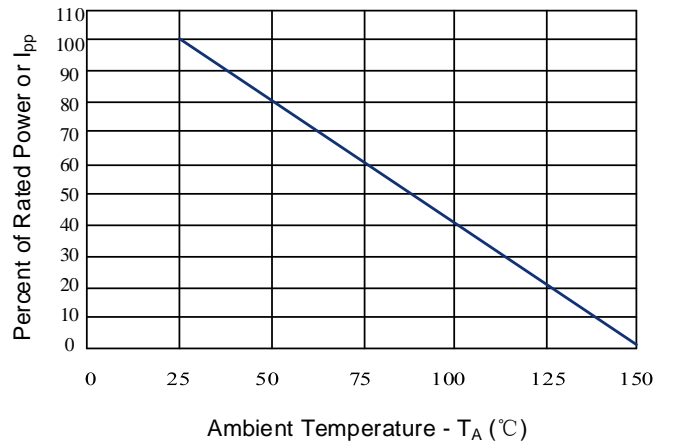

Figure 3: Pulse Waveform

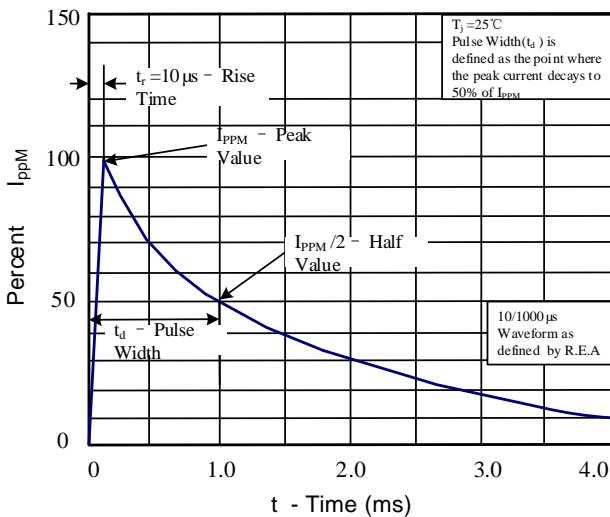

Figure 4: Typical Junction Capacitance

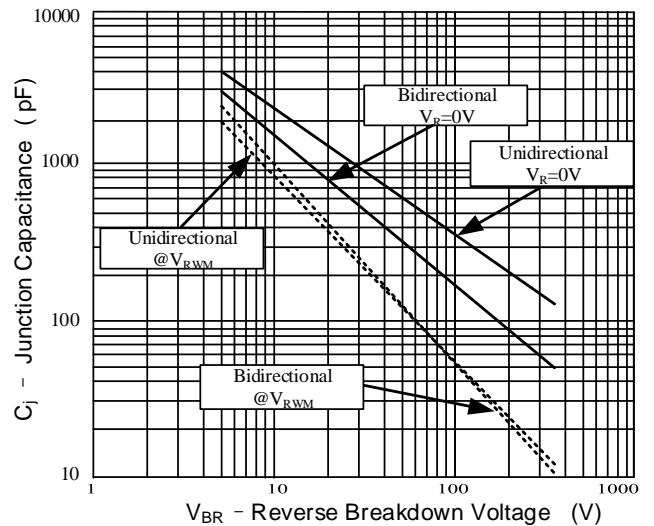

Figure 5: Steady State Power Dissipation Derating Curve

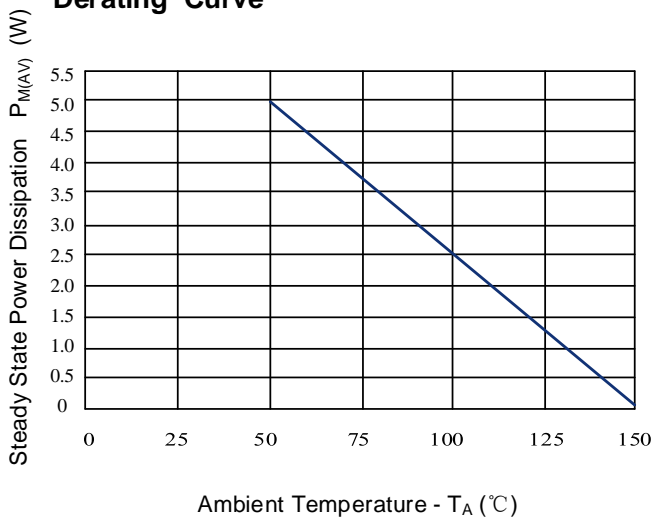
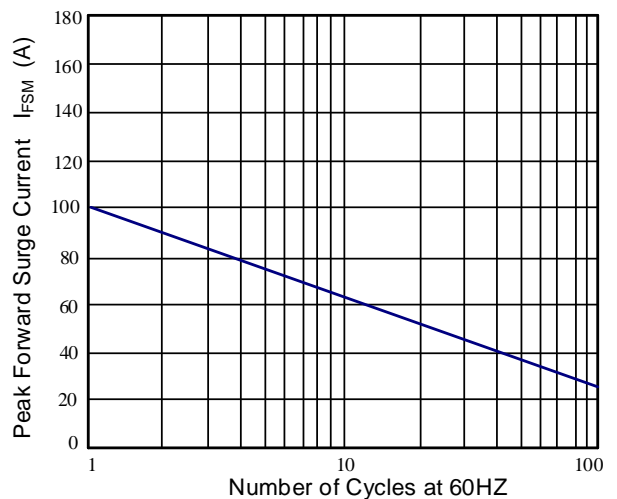
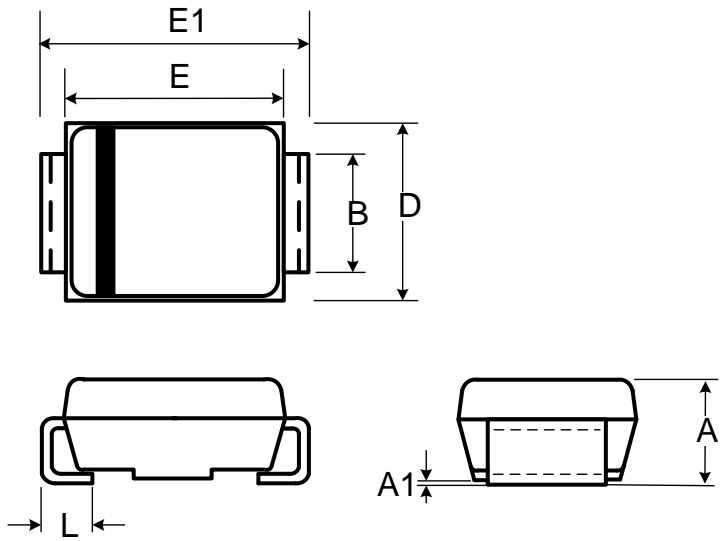

Figure 6: Maximum Non-Repetitive Forward Surge Current Only Unidirectional



Outline Drawing – SMB(DO-214AA)

Ref. (mm)	Millimeters	
	Min.	Max.
A	2.130	2.440
A1	-	0.203
B	1.900	2.200
E	4.100	4.750
E1	5.210	5.590
D	3.300	3.940
L	0.760	1.520



Recommended Solder Pad Layout

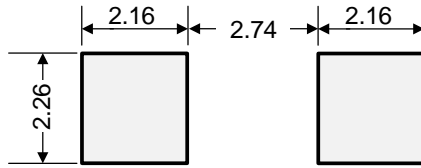

Dimensions in mm

Part Numbering System

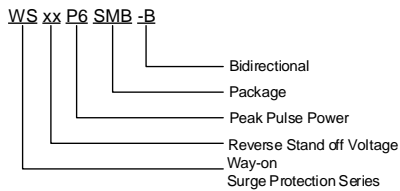

Part Marking System

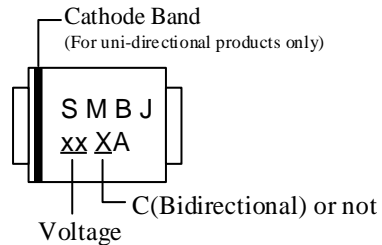

## Package Information

Package Type	Description	Quantity (pcs)	Standard
DO-214AA	Tape & Reel -12mm/13" tape	3000	EIA-481-D

## Contact Information

**CYG WAYON CIRCUIT PROTECTION CO., LTD.**

No.1001, Shiwan(7) Road, Pudong District, Shanghai, P.R.China.201207

Tel: +86-21-68969993 Fax: 86-21-50757680 Email: market@way-on.com

WAYON website: <http://www.way-on.com>

For additional information, please contact your local Sales Representative.

**CYgWAYON**® is registered trademarks of Wayon Corporation.

*Specifications are subject to change without notice.  
The device characteristics and parameters in this data sheet can and do vary in different applications and actual device performance may vary over time.  
Users should verify actual device performance in their specific applications.*