

# WS3222D

## Over-Voltage-Protection Load Switch with Adjustable OVLO threshold

[Http://www.willsemi.com](http://www.willsemi.com)

### Descriptions

The WS3222 is an Over-Voltage-Protection (OVP) load switch with adjustable OVLO threshold voltage. The device will switch off internal MOSFET to disconnect IN to OUT to protect load when any of input voltage over the threshold.

When the OVLO input set below the external OVLO select voltage, the WS3222 automatically chooses the internal fixed OVLO threshold voltage. The over voltage protection threshold voltage can be adjusted with external resistor divider and the OVLO threshold voltage range is 4V~15V. The Over temperature protection (OTP) function monitors chip temperature to protect the device.

The WS3222 is available in DFN2×2-8L Package. Standard products are Pb-free and Halogen-free.

### Features

- Maximum input voltage : 29V
- Switch ON resistance : 45mΩ Typ.
- Ultra fast OVP response time : 450ns Typ.
- Adjust OVLO threshold voltage : 4V~15V

### Applications

- Mobile Handsets and Tablets
- Portable Media Players
- STB, OTT
- Car DVR, Car Media System
- Peripherals

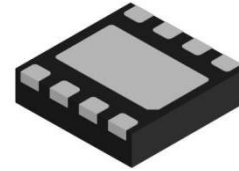

**DFN2×2-8L (Bottom View)**

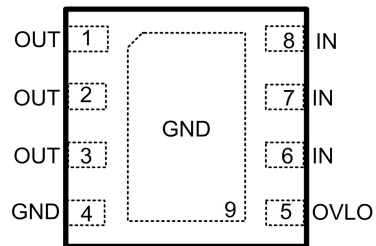

**Pin configuration (Top view)**

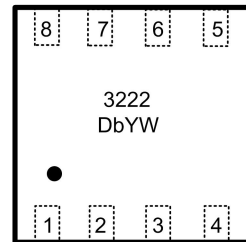

### Marking

- D** = Package code
- b** = Voltage code
- Y** = Year code
- W** = Week code

### Order information

Device	Package	Shipping
WS3222D-8/TR	DFN2×2-8L	3000/Reel&Tape

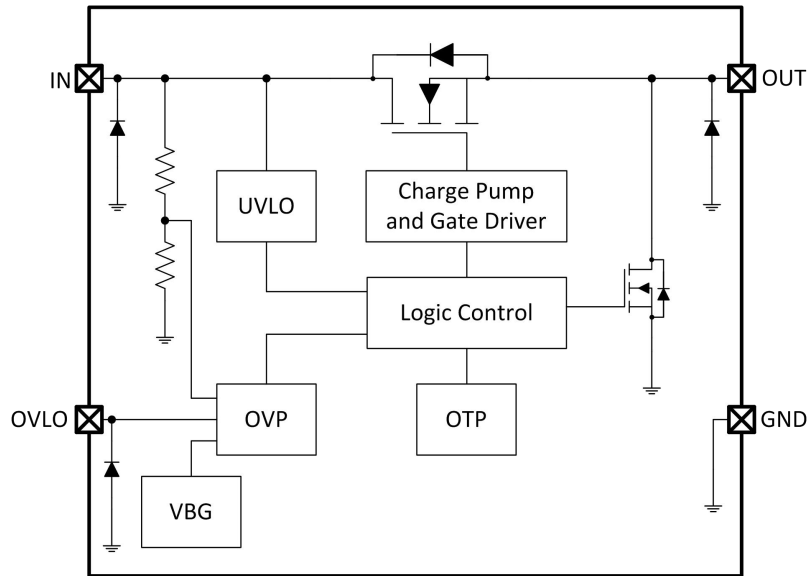
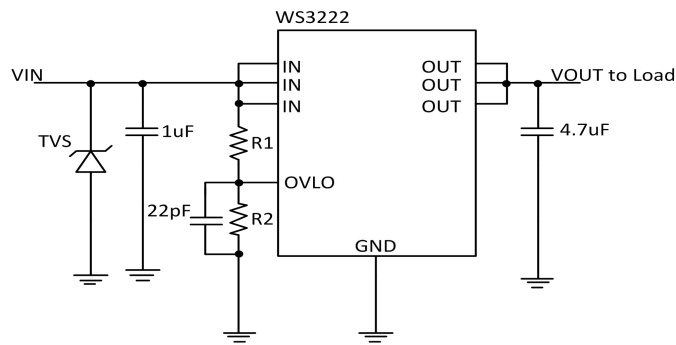
**Function Block Diagram**

**Typical Applications**

Over Voltage Protect with External OVLO Threshold Setting

**Note1:** R1 and R2 are only required for External OVP, otherwise connect OVLO to GND

**Note2:** Recommend  $10K \leq R2 \leq 50K$ ; add unidirection TVS close to VIN

**Pin Descriptions**

Pin No.	Symbol	Descriptions
1, 2, 3	OUT	Output
4	GND	Ground
5	OVLO	OVLO Threshold set pin. Connect a resistor-divider to set different OVLO threshold, $V_{OVLO} = 1.2 \times (1 + R1/R2)$ as shown typical application diagram.
6, 7, 8	IN	Input and Device Power Supply.
9	EXPOSED PAD	Connected to GND.

**Absolute Maximum Ratings**

Parameter	Symbol	Value	Unit
Input voltage (IN pin)	$V_{IN}$	-0.3 ~ 29	V
Output voltage (OUT pin)	$V_{OUT}$	-0.3 ~ 22	V
Input voltage (OVLO pin)	$V_{OVLO}$	-0.3~17	V
MAX Continuous Output current	$I_{OUT}$	3	A
Power dissipation *1 *3	$P_D$	0.5	W
Power dissipation *2 *3		0.3	W
Thermal resistance *1	$R_{\theta JA}$	250	°C/W
Thermal resistance *2		416	°C/W
Junction temperature	$T_J$	150	°C
Lead temperature(10s)	$T_L$	260	°C
Storage temperature	$T_{stg}$	-55 ~ 150	°C
ESD Ratings	HBM	±4000	V
	MM	±200	V

**Note:** These are stress ratings only. Stresses exceeding the ranges specified under “Absolute Maximum Ratings” may cause substantial damage to the device. Functional operation of this device at other conditions beyond those listed in the specification is not implied and prolonged exposure to extreme conditions may affect device reliability.

\*1: Surface mounted on FR-4 Board using 1 square inch pad size, dual side, 1oz copper

\*2: Surface mounted on FR-4 board using minimum pad size, 1oz copper

\*3: Power dissipation is calculated by  $P_D = (V_{IN} - V_{OUT}) \times I_{OUT}$

**Recommend Operating Conditions (Ta=25°C, unless otherwise noted)**

Parameter	Symbol	Value	Unit
Input voltage	$V_{IN}$	2.5 ~ 28	V
Ambient operating temperature	$T_A$	-40 ~ 85	°C

**Electronics Characteristics**( $V_{IN}=5V$ ,  $C_{IN}=1\mu F$ ,  $C_{OUT}=4.7\mu F$ ,  $T_a=25^\circ C$ , unless otherwise noted)

Parameter	Symbol	Conditions	Min.	Typ.	Max.	Units
Input voltage range	$V_{IN}$		2.5		28	V
Quiescent current	$I_Q$	NO Load		110	200	$\mu A$
ON resistance	$R_{ON}$	$V_{IN}=5V$ , $I_{OUT}=1A$		45		$m\Omega$
OVP response time	$T_{OVP}$	$V_{IN}$ rising, $C_{IN}=C_L=0pF$ *1		450		ns
OVLO reference voltage	$V_{OVLO\_TH}$		1.17	1.2	1.23	V
	$V_{OVLO\_HYS}$ *2			35		mV
Adjust OVP voltage range	$V_{OVLO\_RANGE}$	$V_{IN}$ rising	4		15	V
External OVLO select Threshold	$V_{OVLO\_SELECT}$		0.2		0.3	V
UVLO threshold voltage	$V_{UVLO}$	$V_{IN}$ rising		2.25	2.45	V
UVLO hysteresis voltage	$V_{UVLO\_HYS}$	$V_{IN}$ falling		0.25		V
Turn ON time	$T_{ON}$	$V_{IN}>UVLO$ to $V_{OUT}=V_{IN}*90\%$ $C_L=0$		16		ms
Output discharge resistance	$R_{DCHG}$	$V_{IN}=5V$		220		$\Omega$
OTP threshold temperature	$T_{OTP}$	$V_{IN}=5V$		150		$^\circ C$
OTP hysteresis temperature	$T_{HYS}$	$V_{IN}=5V$		20		$^\circ C$

\*1: Guaranteed by design

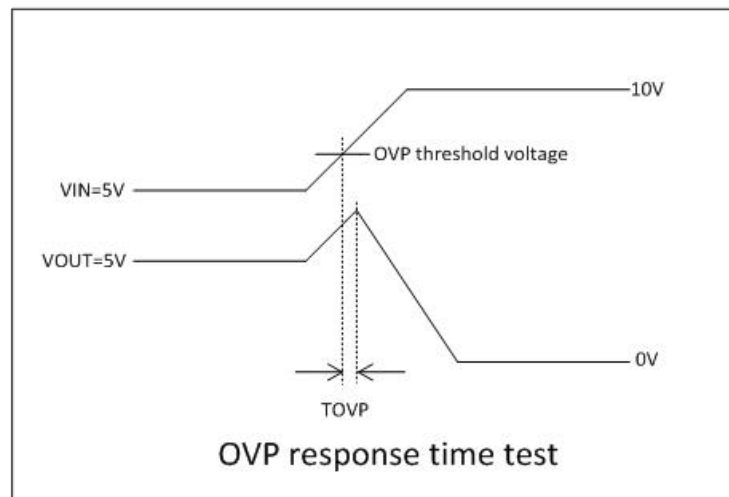

\*2: If connect a resistor-divider to set different OVLO threshold, then  $V_{OVLO\_HYS} = 35 \times (1+R1/R2)$  mV

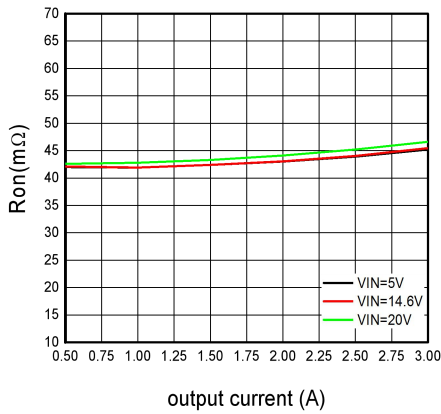
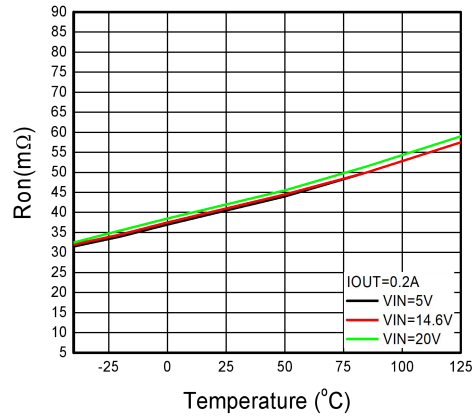
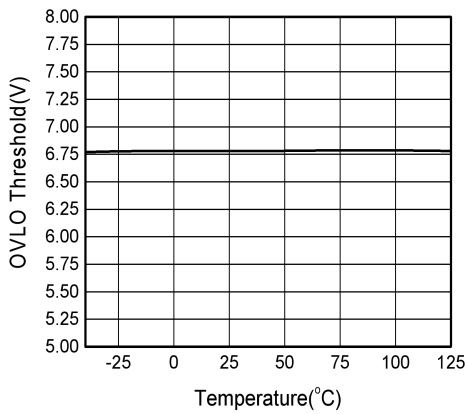
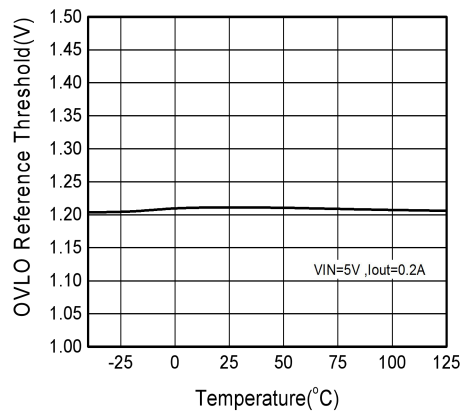
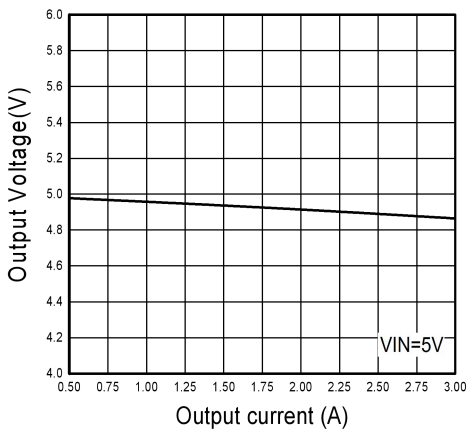
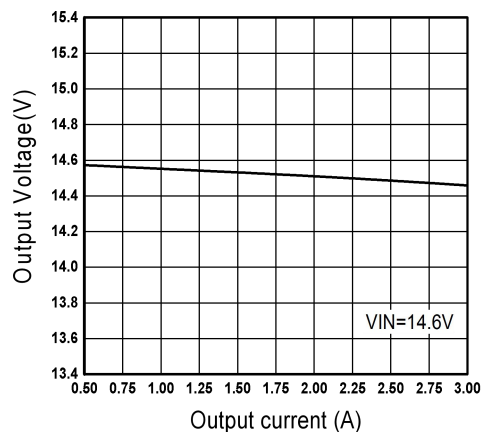
**Typical Characteristics (T<sub>A</sub>=25°C, unless otherwise noted)**

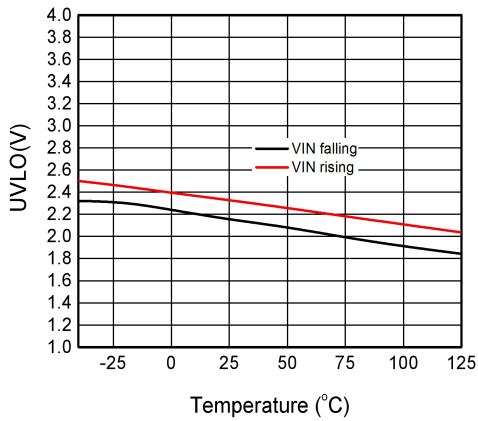
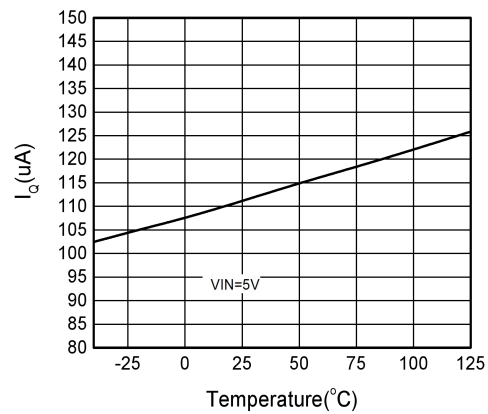
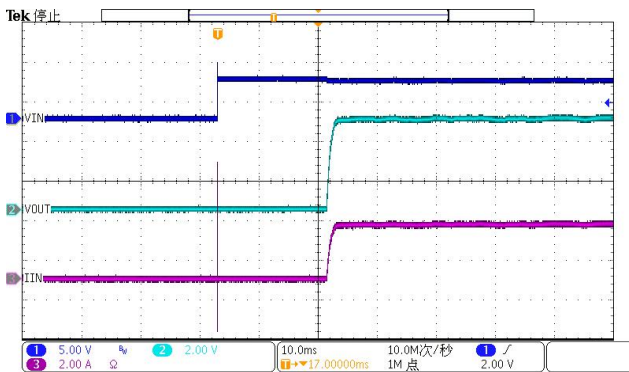
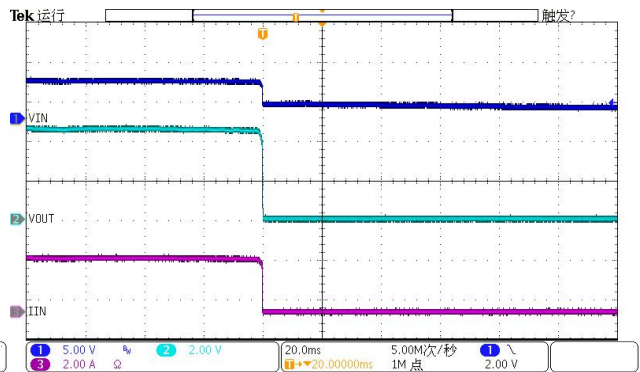
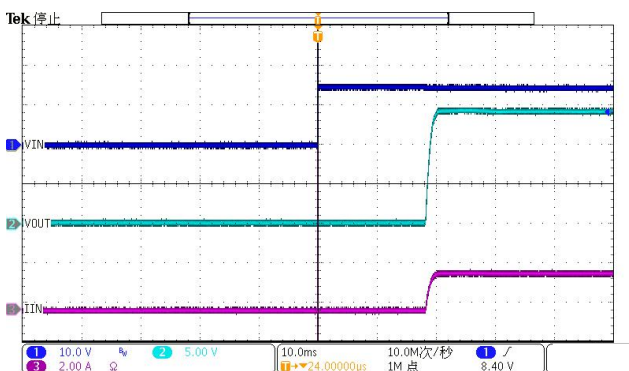
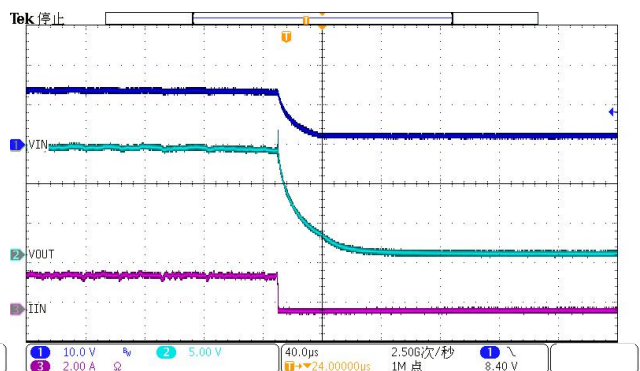
**ON Resistance vs. Load Current**

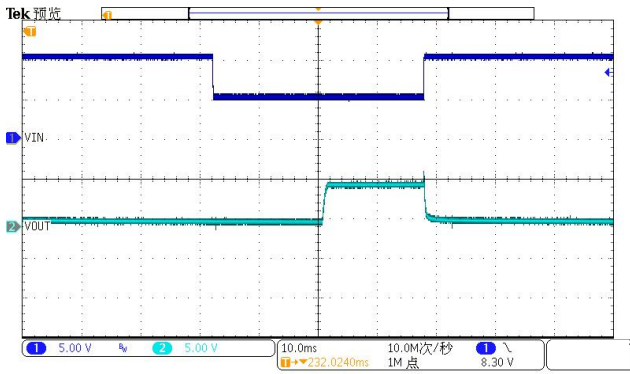
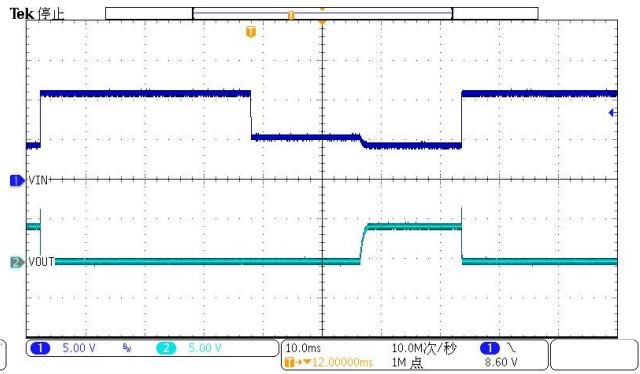
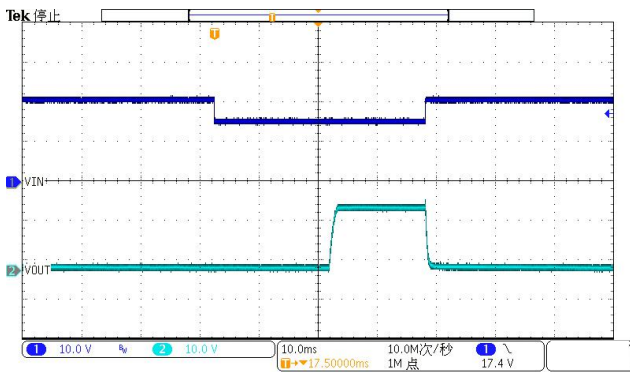
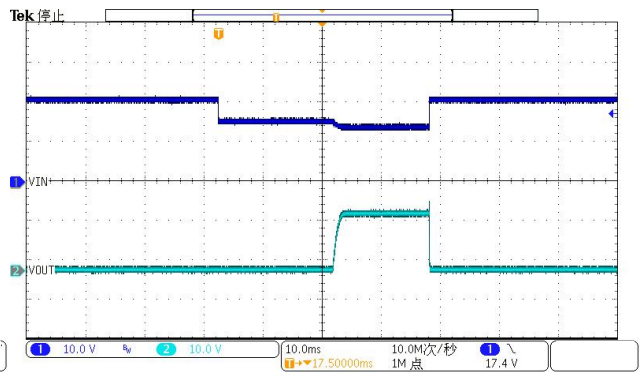
**ON Resistance vs. Temperature**

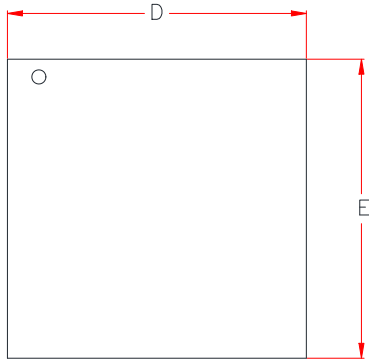
**OVLO Threshold vs. Temperature**

**OVLO Reference Threshold vs. Temperature**

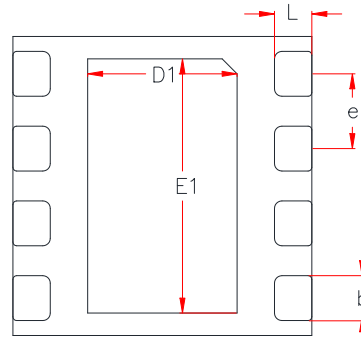
**Output Voltage vs. Output Current**

**Output Voltage vs. Output Current**

**UVLO vs. Temperature**

**Quiescent Current vs. Temperature**

**Power-ON VIN=5V, IOUT=3A, Cout=1uf**

**Power-OFF VIN=5V, IOUT=3A, Cout=1uf**

**Power-ON VIN=14.6V, IOUT=2A, Cout=1uf**

**Power-OFF VIN=14.6V, IOUT=2A, Cout=1uf**



**OVP and OVP Recovery(OVP=6.8V, Iout=0A)**

**OVP and OVP Recovery(OVP=6.8V, Iout=2.5A)**

**OVP and OVP Recovery(OVP=16V, Iout=0A)**

**OVP and OVP Recovery(OVP=16V, Iout=2A)**

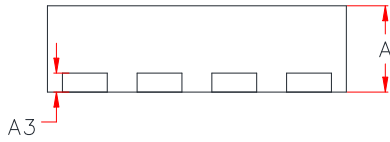
**PACKAGE OUTLINE DIMENSIONS**
**DFN2x2-8L**

TOP VIEW



BOTTOM VIEW



SIDE VIEW

Symbol	Dimensions in Millimeters		
	Min.	Typ.	Max.
A	0.52	0.55	0.58
A3	0.13 Ref.		
L	0.2	0.25	0.30
D	1.90	2.00	2.10
E	1.90	2.00	2.10
D1	0.90	1.00	1.10
E1	1.60	1.70	1.80
e	0.50 Typ.		
b	0.25	0.30	0.35

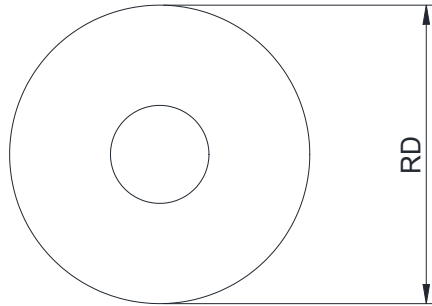
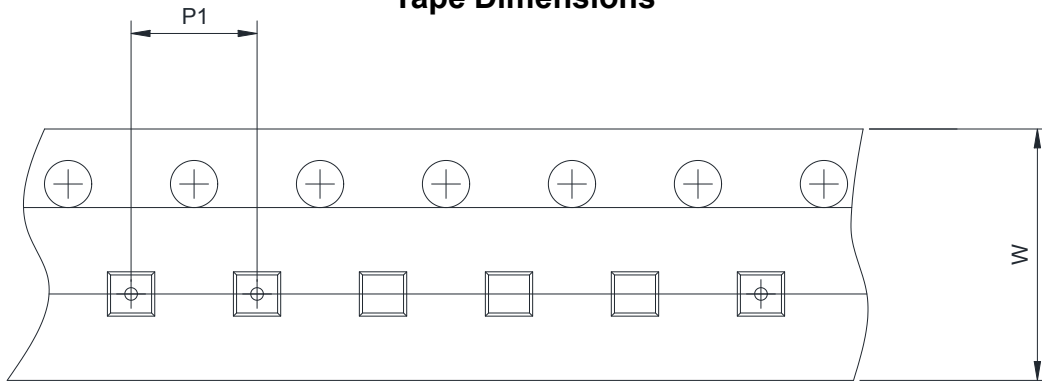
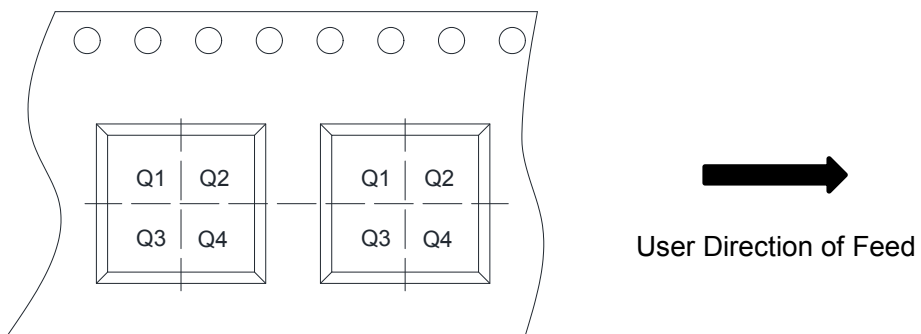

**TAPE AND REEL INFORMATION**
**Reel Dimensions**

**Tape Dimensions**

**Quadrant Assignments For PIN1 Orientation In Tape**

RD	Reel Dimension	<input checked="" type="checkbox"/> 7inch	<input type="checkbox"/> 13inch		
W	Overall width of the carrier tape	<input checked="" type="checkbox"/> 8mm	<input type="checkbox"/> 12mm		
P1	Pitch between successive cavity centers	<input type="checkbox"/> 2mm	<input checked="" type="checkbox"/> 4mm	<input type="checkbox"/> 8mm	
Pin1	Pin1 Quadrant	<input checked="" type="checkbox"/> Q1	<input type="checkbox"/> Q2	<input type="checkbox"/> Q3	<input type="checkbox"/> Q4