

Non-isolated Buck APFC Offline LED Driver

Features

- Internal 650V Power MOSFET
- Active PFC for High Power Factor and Low THD
- Critical Conduction Mode Operation
- System Efficiency up to 95%
- Without auxiliary winding
- Excellent Line and Load Regulation
- $\pm 3\%$ LED Output Current Accuracy
- Thermal Regulation Function
- LED Short/Open Protection
- Current Sensing Resistor Open Protection
- Auto Fault Recovery
- Available in DIP7 Package

Applications

- E27 LED Bulb, Spot Light
- PAR30, PAR38 Lamp
- T8/T10 LED String
- Other LED Lighting

Description

The WS3413H is a high precision non-isolated buck driver with active PFC, specially designed for universal input offline constant current LED lighting. The driver with on-chip PFC circuit achieves high power factor and low THD. Operating in critical conduction mode, the power MOSFET switching loss is reduced and the inductor is fully utilized.

The WS3413H integrates a 650V power MOSFET. With few external components, the LED output current can be precisely controlled.

The WS3413H offers rich protection functions to improve the system reliability, including LED open circuit protection, LED short circuit protection, CS resistor open circuit protection and cycle by cycle current limit. All the protection functions are auto-recovery. The system reliability is further improved by the thermal regulation function. The output current is reduced when the driver is over temperature.

The WS3413H has ultra low start up current and ultra low operating current.

The WS3413H is available in DIP7 Package.

Typical Application

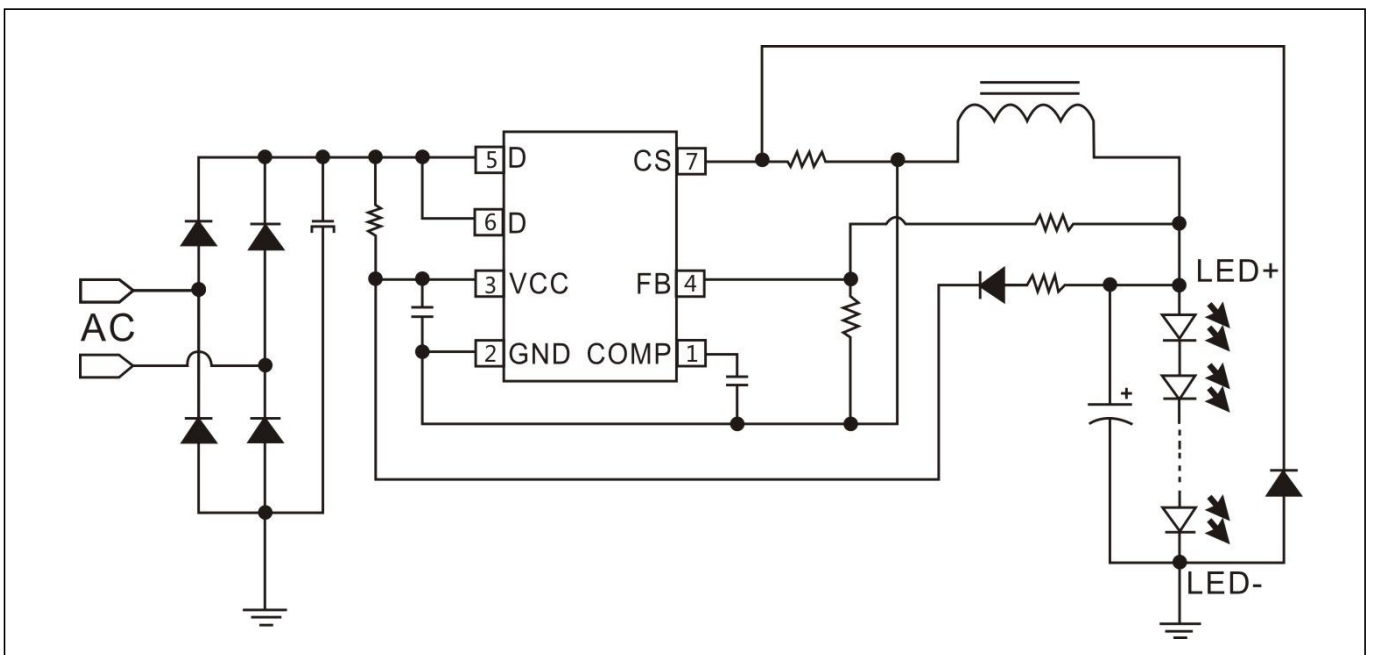

Pin Configuration and Marking Information

The WS3413H is available in DIP7 Package, the top marking is shown as below:

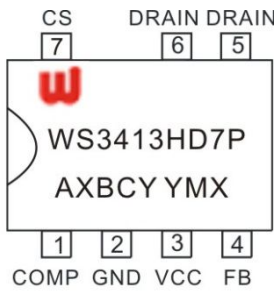

WS3413HD7P
 A: Product Code
 X: Internal Code
 BCY: Internal Code For QC
 YMX: D/C

Pin Definition

Name	Pin No.	Description
COMP	1	Loop Compensation Node. This pin connects a capacitor to GND for stabilization of the control loop, achieving accurate LED current, high Power Factor and low THD.
GND	2	Ground.
VCC	3	Power Supply Pin. Connect a bypass capacitor from this pin to GND.
FB	4	Feedback Voltage Input Pin. This pin detects the inductor demagnetization signal and the output voltage.
D	5/6	Internal HV Power MOSFET Drain.
CS	7	Current Sense Pin. Connect a resistor to GND to sense the inductor current.

Internal Block Diagram

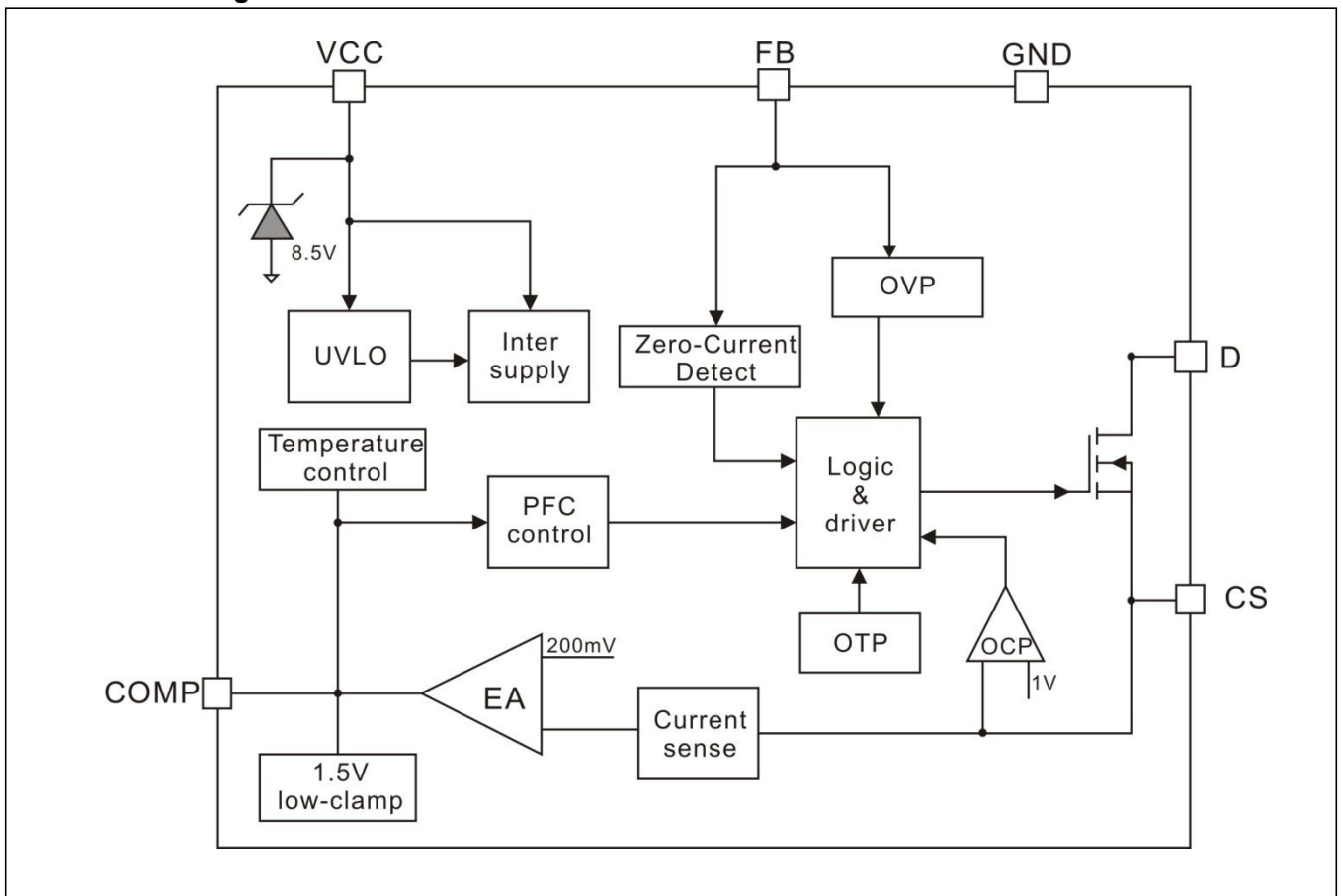

Ordering Information

Package	Marking	Part Number
7-Pin DIP-7, Pb-free	WS3413HD7P	WS3413HD7P

Recommended Operation Conditions

Part Number	Package	Input voltage	Maximum output power
WS3413HD7P	DIP7	175VAC-264VAC	120V/240mA
		90VAC-264VAC	80V/240mA

Absolute Maximum Ratings

symbol	paramete	Range	unit
V_{CC}	Vcc pin voltage	-0.3~8	V
V_D	Internal HV MOSFET Drain to Source voltage	-0.3~650	V
V_{CS}	Current sense pin input voltage	-0.3~7	V
V_{FB}	Feedback pin input voltage	-0.3~7	V
V_{COMP}	Compensation pin voltage	-0.3~7	V
P_{DMAX}	Power dissipation	0.9	W
T_J	Operating junction temperature	165	°C
T_{STG}	Storage temperature range	-55~165	°C

Note : Stresses beyond those listed under “absolute maximum ratings” may cause permanent damage to the device.

Electrical Characteristics (Unless otherwise specified, VCC=8V and TA =25 °C)

Symbol	Parameter	Conditions	Min	Typ	Max	Units
Supply Voltage Section						
V _{cc_clamp}	VCC Clamp Voltage		7.5	8.0	8.5	V
I _{cc_clamp}	VCC Clamp Current			5		mA
V _{CC_ST}	VCC Turn On Threshold	VCC Rising	7.07	7.57	8.07	V
V _{uvlo_HYS}	VCC Turn Off hysteresis	VCC Falling		1.32		V
I _{st}	VCC Startup Current	VCC<VCC_ST-0.5V		70	100	uA
I _{op}	VCC Operating Current			400		uA
Current Sense Section						
V _{ocp}	Over current Protection threshold			1		V
T _{LEB}	Leading Edge Blanking Time for Current Sense			350		ns
T _d	Switch off Delay Time			200		ns
Compensation Section						
V _{REF}	Internal Reference Voltage		194	200	206	mV
V _{CL}	COMP Low Clamp Voltage			1.5		V
V _{CH}	COMP High Clamp Voltage			4		V
Internal driver						
T _{OFF_MIN}	Minimum Off Time			3		us
T _{ON_MAX}	Maximum On Time			20		us
Feedback Section						
V _{FB}	FB Over Voltage Protection Threshold			1.6		V
V _{ZCD}	FB Falling Edge Threshold Voltage			0.2		V
Power MOSFET						
R _{DS(on)}	Static Drain-source On-resistance			2.8	3.5	Ω
V _{DS}	Drain-Source Breakdown Voltage		650			V
Thermal Regulation Section						
T _{REG}	Thermal Regulation Temperature			150		°C

Application Information

The WS3413H is a high precision Active PFC driver integrating 650V power MOSFET, specially designed for non-isolated buck offline constant current LED lighting. Operating in critical conduction mode, the driver achieves high power factor, low THD and high efficiency.

Start Up

After system powered up, the VCC pin capacitor is charged up by the start up resistor. When the VCC pin voltage reaches the turn on threshold, the internal circuits start working. The COMP pin voltage is pulled up to 1.5V quickly, then the WS3413H starts switching. The system works at 10k Hz frequency at the beginning, the COMP voltage rises up gradually, and the inductor peak current also rises up. The LED current hence achieves a soft start without overshoot. After the output voltage is built up, the VCC power is supplied by the output voltage through a diode.

The maximum value of the startup current is 100uA. For the application of 85VAC—264VAC, the startup resistor can be calculated by the equation:

$$R_{st} < \frac{V_{in_min}}{I_{st_max}} \approx \frac{85V}{100\mu A} = 850K\Omega$$

Constant Current Control

The WS3413H utilizes floating ground structure. The inductor current is sensed during the whole switching cycle, thus it achieves high precision output current control and also excellent line and load regulation.

The current in LED can be calculated by the equation:

$$I_O = \frac{V_{CS}}{R_{CS}} = \frac{200mV}{R_{CS}}$$

Rcs is the current sensing resistor.

Feedback Network

The WS3413H senses the output current zero crossing information through the feedback network, the FB falling threshold voltage is set to 0.2V with 0.15V hysteresis. The FB pin is also used to detect output OVP, the threshold voltage is 1.6V. The ratio of FB upper resistor to lower resistor can be set as:

$$\frac{R_{FBL}}{R_{FBL} + R_{FBH}} = \frac{1.6V}{V_{OVP}}$$

Where,

RFBL: The lower resistor of the feedback network

RFBH: The upper resistor of the feedback network

VOVP: Output over voltage setting point

The minimum VOVP should be set about 1.3Vo. It is recommended that the FB lower resistor is set to 3.3KΩ—5.1KΩ paralleled with a 22pF ceramic capacitor.

Protection Functions

The WS3413H offers rich protection functions to improve the system reliability.

When the LED is open circuit, the output voltage will gradually rise up. The output voltage is sensed by the FB pin when power MOSFET is turned off. When FB voltage reaches the OVP threshold, it will trigger fault logic and the system stops switching.

When the LED is shorted circuit, the system will work under 10k Hz switching frequency. Meanwhile, the output voltage is low and the VCC pin cannot be charged up by the output voltage, so the VCC pin voltage will gradually decrease and finally reaches the UVLO threshold.

After the system enters into fault condition, the VCC voltage will decrease until it reaches UVLO threshold. Then the system will re-start again. If the fault condition is removed, the system will resume normal operation.

When the output is short circuit or the inductor is saturated, the CS peak voltage will be relatively high. When CS voltage reaches the internal limitation (1V), the power MOSFET will be turned off instantaneously. This cycle by cycle current limitation can help protecting the power MOSFET, the inductor and the output diode.

Thermal Regulation

The WS3413H integrates thermal regulation function. When the system is over temperature, the output current is gradually reduced; the output power and thermal dissipation are also reduced. The system temperature is regulated and the system reliability is improved. The thermal regulation temperature is set to 150°C internally.

PCB Layouts

The following guidelines should be followed in WS3413H PCB layout:

Bypass Capacitor

The bypass capacitor on VCC pin should be as close as possible to the VCC and GND pins.

Ground Path

The power ground path for current sense resistor should be short and wide, and it should be as close as possible to the IC ground (pin 2), otherwise the LED output current accuracy maybe affected. The IC signal ground for COMP and FB components should be connected to the IC GND pin with short traces and should be away from the power ground path.

The Area of Power Loop

The area of main current loop should be as small as possible to reduce EMI radiation.

FB Pin

The feedback resistor divider should be as close as possible to the FB pin, and the trace must keeps away from dynamic node of the inductor (DRAIN pin trace、 the positive pin and the negative pin of Vo trace), otherwise the FB pin OVP function might have risk to be mis-triggered by the system noise.

DRAIN Pin

To increase the copper area of DRAIN pin for better thermal dissipation. However, too large copper area may compromise EMI performance.

The material of PCB

Avoid choosing the material that is easy to absorb the moisture, just like paper copper-clad laminates.

Package Information

DIP7Package Outline Dimensions

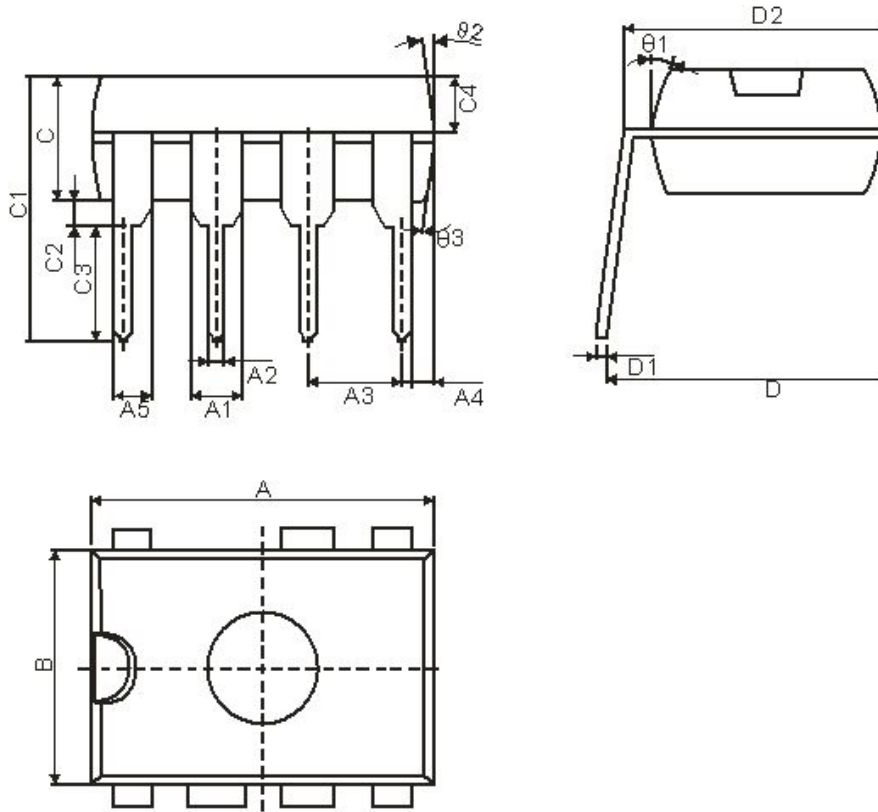

Winsemi				
Symbol	Dimensions in Millimeters		Dimensions in Inches	
	Min	Max	Min	Max
A	9.00	9.50	0.354	0.374
B	6.10	6.60	0.240	0.260
C	3.0	3.4	0.118	0.134
A1	1.474	1.574	0.058	0.062
A2	0.41	0.53	0.016	0.021
A3	2.44	2.64	0.096	0.104
A4	0.51TYP		0.02TYP	
A5	0.99TYP		0.04TYP	
C1	6.6	7.30	0.260	0.287
C2	0.50TYP		0.02TYP	
C3	3.00	3.40	0.118	0.134
C4	1.47	1.65	0.058	0.065
D	7.62	9.3	0.300	0.366
D1	0.24	0.32	0.009	0.013
D2	7.62TYP		0.3TYP	

NOTE:

1. We strongly recommend customers check carefully on the trademark when buying our product, if there is any question, please don't be hesitate to contact us.
2. Please do not exceed the absolute maximum ratings of the device when circuit designing.
3. Winsemi Microelectronics Co., Ltd reserved the right to make changes in this specification sheet and is subject to change without prior notice.

CONTACT:

Winsemi Microelectronics Co., Ltd.

ADD: Futian District, ShenZhen Tian An Cyber Tech Plaza two East Wing 1002

Post Code : 518040

Tel : +86-755-8250 6288

FAX : +86-755-8250 6299

Web Site : www.winsemi.com