

Features

- 600 watts Peak Pulse Power (10/1000 μ s)
- Unidirectional and Bidirectional Protection
- Fast Response Time : Typically < 1ns
- Excellent Clamping Capability
- Glass Passivated Junction
- Built-in Strain relief
- Low inductance
- Low profile package
- High temperature solder:260°C/10 seconds at terminal

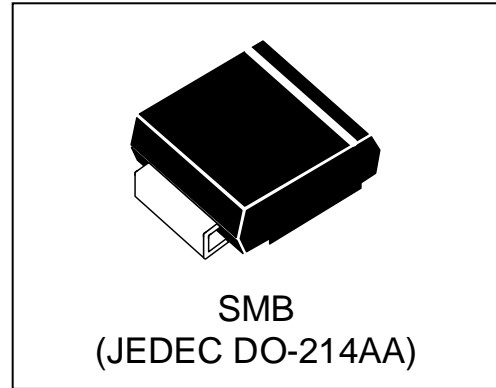

Mechanical Characteristics

- JEDEC DO-214AA package
- Molding compound flammability rating: UL 94V-0
- Marking : Marking Code
- Packaging : Tape and Reel per EIA 481
- RoHS &UL497B Compliant

Applications

- I/O Interfaces
- Power lines
- Automotive and Telecommunication
- Computers & Consumer Electronics
- Industrial Electronics

| Absolute Maximum Rating | | | |
|---|------------------|--------------------------------|-------|
| Rating | Symbol | Value | Units |
| Peak Pulse Power (tp =10/1000 μ s) (see Note1,2& 3) | P _{PPM} | 600 | Watts |
| Peak pulse current (10/1000 μ s) (see Note2&3) | I _{PPM} | See Electrical Characteristics | A |
| Peak Forward surge current (see Note4&5) | I _{FSM} | 100 | A |
| Power Dissipation on infinite heat sink T _A = 50 °C (Fig5) | P _D | 5.0 | W |
| Operating Junction Temperature range | T _J | -65 to + 150 | °C |
| Storage Temperature range | T _{STG} | -65 to + 150 | °C |

Note1: Peak Pulse Power Rating as Pulse Width per Fig1.

Note2: Peak Pulse Power or Current Derated above TA=25°C Per Fig. 2 and Non-Repetitive Current Pulse, Per Fig.3.

Note3: Mounted on 5.0x5.0mm² copper pad to each terminal.

Note4: 8.3ms Single Half Sine Wave or Equivalent Square Wave.

Note5: Maximum Forward Surge Current only for Unidirectional Device per Fig6.

Electrical Characteristics

| Part Number | | Reverse Stand off Voltage V_{RWM} (Volts) | Breakdown Voltage $V_{BR}(\text{Volts})@I_T$ | | Test Current I_T (mA) | Maximum Clamping Voltage $V_c@I_{PP}$ (Volts) | Maximum Peak Pulse Current I_{pp} (Amps) | Maximum Reverse Leakage $I_R@V_{RWM}$ (μA) |
|-------------|--------------|---|---|-------|-------------------------------|---|--|---|
| | | | MIN | MAX | | | | |
| UNI-POLAR | BI-POLAR | | | | | | | |
| WS5.0P6SMB | WS5.0P6SMB-B | 5.0 | 6.40 | 7.07 | 10 | 9.2 | 65.2 | 800 |
| WS6.0P6SMB | WS6.0P6SMB-B | 6.0 | 6.67 | 7.37 | 10 | 10.3 | 58.3 | 800 |
| WS6.5P6SMB | WS6.5P6SMB-B | 6.5 | 7.22 | 7.98 | 10 | 11.2 | 53.6 | 500 |
| WS7.0P6SMB | WS7.0P6SMB-B | 7.0 | 7.78 | 8.60 | 10 | 12.0 | 50.0 | 200 |
| WS7.5P6SMB | WS7.5P6SMB-B | 7.5 | 8.33 | 9.21 | 1 | 12.9 | 46.5 | 100 |
| WS8.0P6SMB | WS8.0P6SMB-B | 8.0 | 8.89 | 9.83 | 1 | 13.6 | 44.1 | 50 |
| WS8.5P6SMB | WS8.5P6SMB-B | 8.5 | 9.44 | 10.40 | 1 | 14.4 | 41.7 | 20 |
| WS9.0P6SMB | WS9.0P6SMB-B | 9.0 | 10.00 | 11.10 | 1 | 15.4 | 39.0 | 10 |
| WS10P6SMB | WS10P6SMB-B | 10 | 11.10 | 12.30 | 1 | 17.0 | 35.3 | 5 |
| WS11P6SMB | WS11P6SMB-B | 11 | 12.20 | 13.50 | 1 | 18.2 | 33.0 | 5 |
| WS12P6SMB | WS12P6SMB-B | 12 | 13.30 | 14.7 | 1 | 19.9 | 30.2 | 5 |
| WS13P6SMB | WS13P6SMB-B | 13 | 14.40 | 15.90 | 1 | 21.5 | 27.9 | 1 |
| WS14P6SMB | WS14P6SMB-B | 14 | 15.60 | 17.20 | 1 | 23.2 | 25.9 | 1 |
| WS15P6SMB | WS15P6SMB-B | 15 | 16.70 | 18.50 | 1 | 24.4 | 24.6 | 1 |
| WS16P6SMB | WS16P6SMB-B | 16 | 17.80 | 19.70 | 1 | 26.0 | 23.1 | 1 |
| WS17P6SMB | WS17P6SMB-B | 17 | 18.90 | 20.90 | 1 | 27.6 | 21.7 | 1 |
| WS18P6SMB | WS18P6SMB-B | 18 | 20.00 | 22.10 | 1 | 29.2 | 20.5 | 1 |
| WS20P6SMB | WS20P6SMB-B | 20 | 22.20 | 24.50 | 1 | 32.4 | 18.5 | 1 |
| WS22P6SMB | WS22P6SMB-B | 22 | 24.40 | 26.90 | 1 | 35.5 | 16.9 | 1 |
| WS24P6SMB | WS24P6SMB-B | 24 | 26.70 | 29.50 | 1 | 38.9 | 15.4 | 1 |
| WS26P6SMB | WS26P6SMB-B | 26 | 28.90 | 31.90 | 1 | 42.1 | 14.3 | 1 |
| WS28P6SMB | WS28P6SMB-B | 28 | 31.10 | 34.40 | 1 | 45.4 | 13.2 | 1 |
| WS30P6SMB | WS30P6SMB-B | 30 | 33.30 | 36.80 | 1 | 48.4 | 12.4 | 1 |
| WS33P6SMB | WS33P6SMB-B | 33 | 36.70 | 40.60 | 1 | 53.3 | 11.3 | 1 |
| WS36P6SMB | WS36P6SMB-B | 36 | 40.00 | 44.20 | 1 | 58.1 | 10.3 | 1 |
| WS40P6SMB | WS40P6SMB-B | 40 | 44.40 | 49.10 | 1 | 64.5 | 9.3 | 1 |
| WS43P6SMB | WS43P6SMB-B | 43 | 47.80 | 52.80 | 1 | 69.4 | 8.6 | 1 |
| WS45P6SMB | WS45P6SMB-B | 45 | 50.00 | 55.30 | 1 | 72.7 | 8.3 | 1 |

Electrical Characteristics (Cont.)

| Part Number | | Reverse Stand off Voltage V_{RWM} (Volts) | Breakdown Voltage $V_{BR}(\text{Volts})@I_T$ | | Test Current I_T (mA) | Maximum Clamping Voltage $V_C@I_{PP}$ (Volts) | Maximum Peak Pulse Current I_{pp} (Amps) | Maximum Reverse Leakage $I_R@V_{RWM}$ (μA) |
|-------------|--------------|---|---|-------|-------------------------------|---|--|---|
| | | | MIN | MAX | | | | |
| UNI-POLAR | BI-POLAR | | | | | | | |
| WS48P6SMB | WS48P6SMB-B | 48 | 53.30 | 58.90 | 1 | 77.4 | 7.8 | 1 |
| WS51P6SMB | WS51P6SMB-B | 51 | 56.70 | 62.70 | 1 | 82.4 | 7.3 | 1 |
| WS54P6SMB | WS54P6SMB-B | 54 | 60.00 | 66.30 | 1 | 87.1 | 6.9 | 1 |
| WS58P6SMB | WS58P6SMB-B | 58 | 64.40 | 71.20 | 1 | 93.6 | 6.4 | 1 |
| WS60P6SMB | WS60P6SMB-B | 60 | 66.70 | 73.70 | 1 | 96.8 | 6.2 | 1 |
| WS64P6SMB | WS64P6SMB-B | 64 | 71.10 | 78.60 | 1 | 103 | 5.8 | 1 |
| WS70P6SMB | WS70P6SMB-B | 70 | 77.80 | 86.00 | 1 | 113 | 5.3 | 1 |
| WS75P6SMB | WS75P6SMB-B | 75 | 83.30 | 92.10 | 1 | 121 | 5.0 | 1 |
| WS78P6SMB | WS78P6SMB-B | 78 | 86.70 | 95.80 | 1 | 126 | 4.8 | 1 |
| WS85P6SMB | WS85P6SMB-B | 85 | 94.40 | 104 | 1 | 137 | 4.4 | 1 |
| WS90P6SMB | WS90P6SMB-B | 90 | 100 | 111 | 1 | 146 | 4.1 | 1 |
| WS100P6SMB | WS100P6SMB-B | 100 | 111 | 123 | 1 | 162 | 3.7 | 1 |
| WS110P6SMB | WS110P6SMB-B | 110 | 122 | 135 | 1 | 177 | 3.4 | 1 |
| WS120P6SMB | WS120P6SMB-B | 120 | 133 | 147 | 1 | 193 | 3.1 | 1 |
| WS130P6SMB | WS130P6SMB-B | 130 | 144 | 159 | 1 | 209 | 2.9 | 1 |
| WS150P6SMB | WS150P6SMB-B | 150 | 167 | 185 | 1 | 243 | 2.5 | 1 |
| WS160P6SMB | WS160P6SMB-B | 160 | 178 | 197 | 1 | 259 | 2.3 | 1 |
| WS170P6SMB | WS170P6SMB-B | 170 | 189 | 209 | 1 | 275 | 2.2 | 1 |
| WS180P6SMB | WS180P6SMB-B | 180 | 201 | 222 | 1 | 292 | 2.1 | 1 |
| WS200P6SMB | WS200P6SMB-B | 200 | 224 | 247 | 1 | 324 | 1.9 | 1 |
| WS220P6SMB | WS220P6SMB-B | 220 | 246 | 272 | 1 | 356 | 1.7 | 1 |
| WS250P6SMB | WS250P6SMB-B | 250 | 279 | 309 | 1 | 405 | 1.5 | 1 |
| WS300P6SMB | WS300P6SMB-B | 300 | 335 | 371 | 1 | 486 | 1.3 | 1 |
| WS350P6SMB | WS350P6SMB-B | 350 | 391 | 432 | 1 | 567 | 1.1 | 1 |
| WS400P6SMB | WS400P6SMB-B | 400 | 447 | 494 | 1 | 648 | 0.9 | 1 |
| WS440P6SMB | WS440P6SMB-B | 440 | 492 | 543 | 1 | 713 | 0.9 | 1 |

Typical Characteristics

Figure 1: Peak Pulse Power Rating Curve

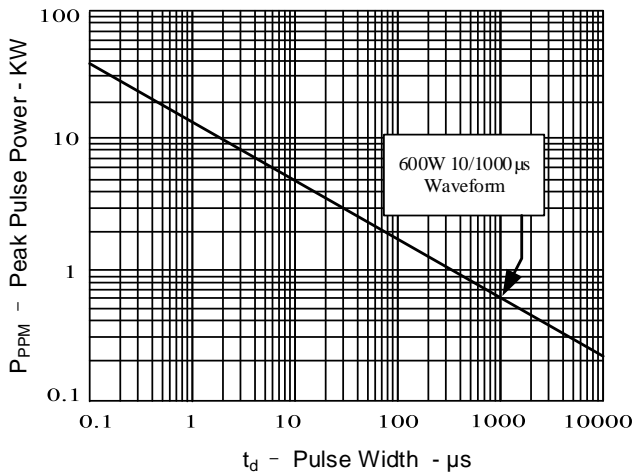

Figure 2: Pulse Derating Curve

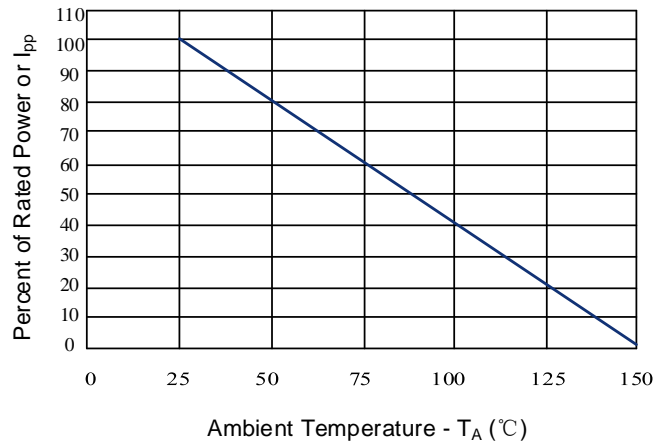

Figure 3: Pulse Waveform

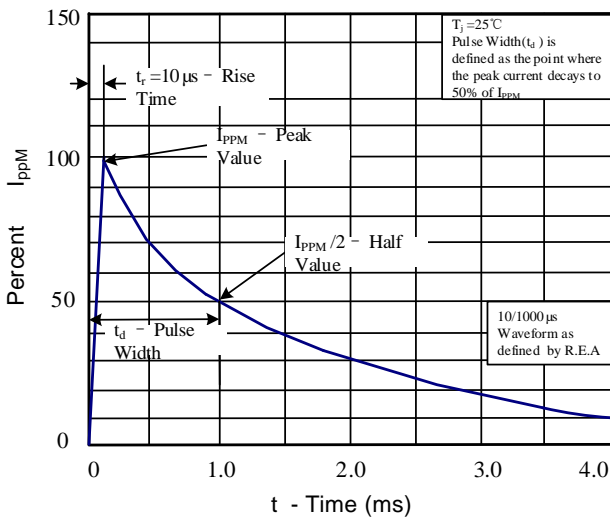

Figure 4: Typical Junction Capacitance

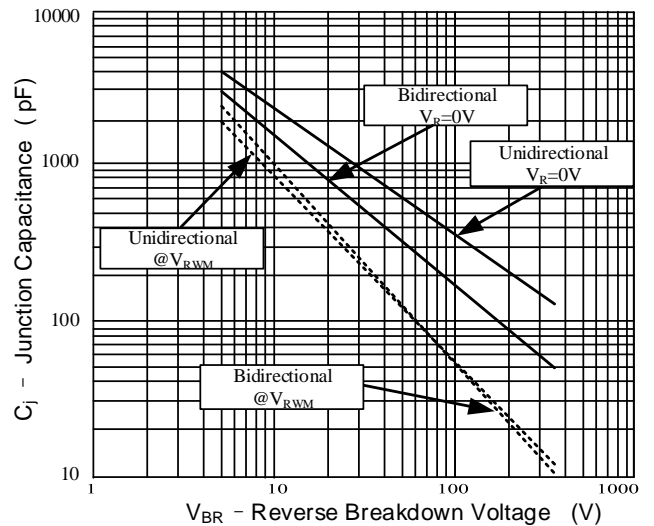

Figure 5: Steady State Power Dissipation Derating Curve

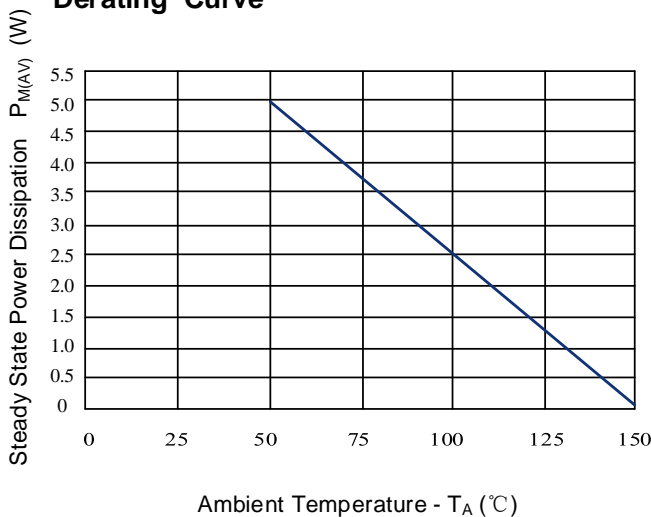
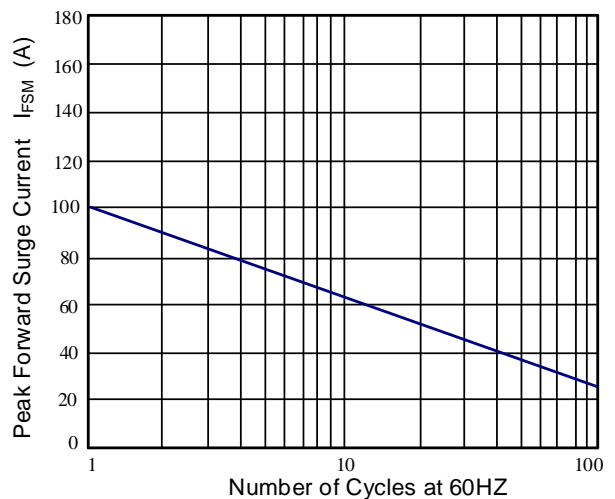
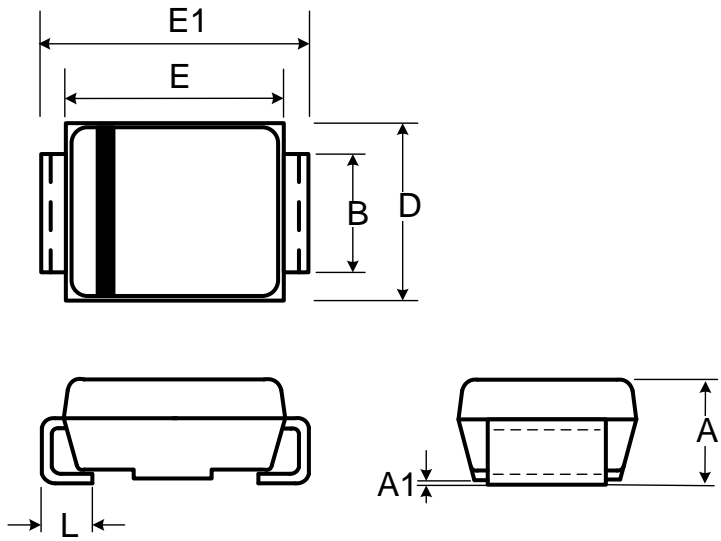

Figure 6: Maximum Non-Repetitive Forward Surge Current Only Unidirectional



Outline Drawing – SMB(DO-214AA)

| Ref. (mm) | Millimeters | |
|-----------|-------------|-------|
| | Min. | Max. |
| A | 2.130 | 2.440 |
| A1 | - | 0.203 |
| B | 1.900 | 2.200 |
| E | 4.100 | 4.750 |
| E1 | 5.210 | 5.590 |
| D | 3.300 | 3.940 |
| L | 0.760 | 1.520 |



Recommended Solder Pad Layout

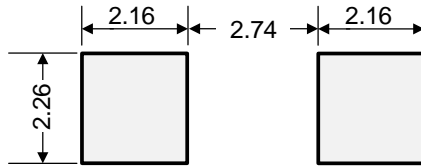

Dimensions in mm

Part Numbering System

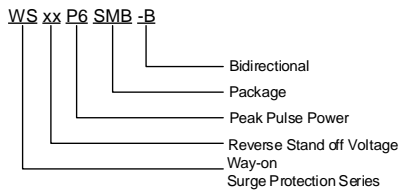

Part Marking System

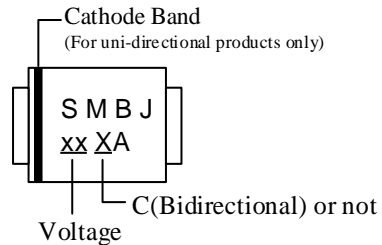

Package Information

| Package Type | Description | Quantity (pcs) | Standard |
|--------------|----------------------------|----------------|-----------|
| DO-214AA | Tape & Reel -12mm/13" tape | 3000 | EIA-481-D |

Contact Information

CYG WAYON CIRCUIT PROTECTION CO., LTD.

No.1001, Shiwan(7) Road, Pudong District, Shanghai, P.R.China.201207

Tel: +86-21-68969993 Fax: 86-21-50757680 Email: market@way-on.com

WAYON website: <http://www.way-on.com>

For additional information, please contact your local Sales Representative.

CYG WAYON ® is registered trademarks of Wayon Corporation.Specifications are subject to change without notice.The device characteristics and parameters in this data sheet can and do vary in different applications and actual device performance may vary over time.
Users should verify actual device performance in their specific applications.