

WS4665

6A, 14mΩ Load Switch with Quick Output Discharge and Adjustable Rise Time

<http://www.sh-willsemi.com>

DESCRIPTION

The WS4665 is a single channel load switch that provides configurable rise time to minimize inrush current. The device contains an N-channel MOSFET that can operate over an input voltage range of 0.8V to 5.5V and can support a maximum continuous current of 6A. The switch is controlled by an on/off input (ON), which is capable of interfacing directly with low-voltage control signals. In the WS4665, a 230 Ω on-chip load resistor is added for quick output discharge when switch is turned off.

The WS4665 is available in a small, space-saving 2.00mm x 2.00mm 8-pin DFN package.

FEATURES

- I Integrated Single Channel Load Switch
- I Input Voltage Range: 0.8V to 5.5V
- I Ultra-Low On Resistance (R_{ON})
 - $R_{ON} = 14m\Omega$ at $V_{IN} = 5V$ ($V_{BIAS} = 5V$)
- I 6-A Maximum Continuous Switch Current
- I Low Control Input Threshold Enables Use of 1.2-V, 1.8-V, 2.5-V and 3.3-V Logic
- I Configurable Rise Time
- I Quick Output Discharge (QOD)
- I DFN8 2x2 8L Package
- I ESD Performance Tested per JESD 22
 - 2000V HBM and 1000V CDM

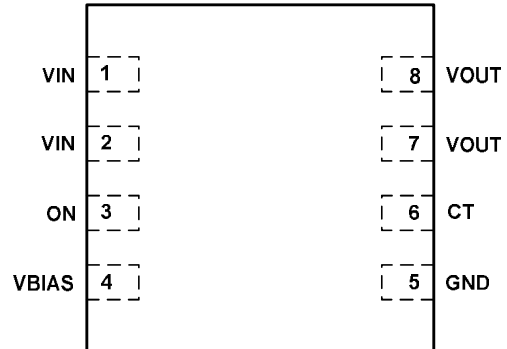

Pin configuration (Top view)



DFN2x2-8L

4665 = Device code
DA = Package code
Y = Year code
W = Week code
Marking

Order information

Device	Package	Shipping
WS4665D-8/TR	DFN2x2-8L	3000/Reel&Tape

APPLICATIONS

- I Ultrabook™
- I Notebooks/Netbooks
- I Tablet PC
- I Consumer Electronics
- I Set-top Boxes/Residential Gateways
- I Telecom Systems

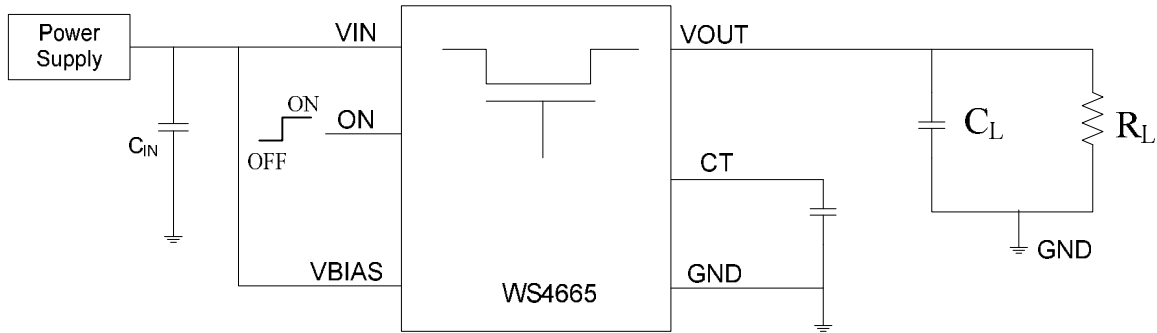
TYPICAL APPLICATION

Typical Application

PIN DESCRIPTION

PIN No.	PIN NAME	I/O	DESCRIPTION
1	VIN	I	Switch input. Input bypass capacitor recommended for minimizing V_{IN} dip.
2	VIN	I	Switch input. Input bypass capacitor recommended for minimizing V_{IN} dip.
3	ON	I	Active high switch control input. Do not leave floating.
4	VBIAS	I	Bias voltage. Power supply to the device. Recommended voltage range for this pin is 2.5V to 5.5V.
5	GND	-	Device ground.
6	CT	O	Switch slew rate control. Can be left floating.
7	VOUT	O	Switch output.
8	VOUT	O	Switch output.

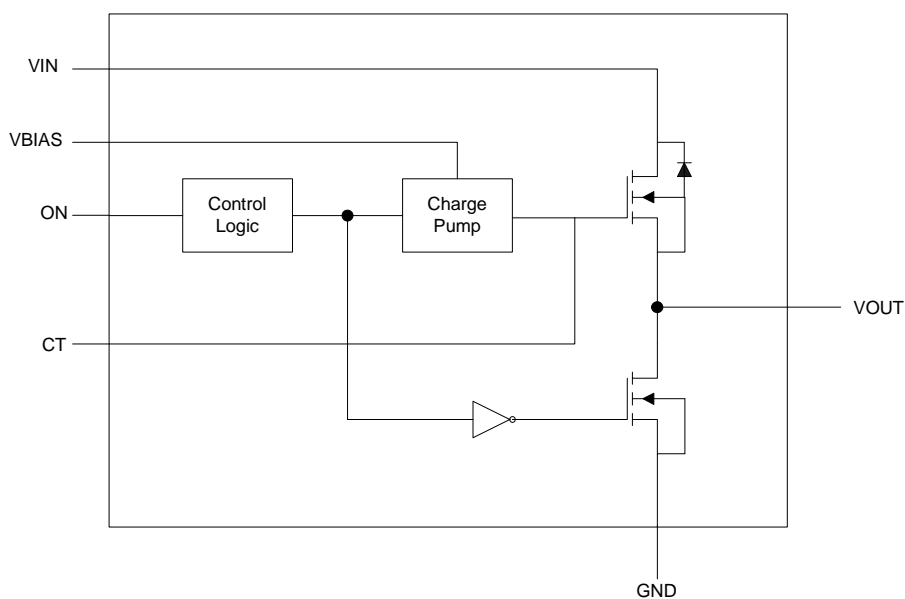
BLOCK DIAGRAM

ABSOLUTE MAXIMUM RATINGS

Symbol	Parameter	Value	Unit	
V _{IN}	Input voltage range	-0.3 to 6	V	
V _{OUT}	Output voltage range	-0.3 to 6	V	
V _{BIAS}	Bias voltage range	-0.3 to 6	V	
V _{ON}	Input voltage range	-0.3 to 6	V	
I _{MAX}	Maximum continuous switch current	6	A	
I _{PLS}	Maximum pulsed switch current, pulse < 300uS, 2% duty cycle	8	A	
T _A	Operating free-air temperature range ^(Note1)	-40 to 85	°C	
T _J	Maximum junction temperature	150	°C	
T _{STG}	Storage temperature range	-60 to 150	°C	
T _{LEAD}	Maximum lead temperature (10-s soldering time)	300	°C	
ESD	Electrostatic discharge protection	Human-Body Model (HBM)	2000	V
		Charged-Device Model (CDM)	1000	

These are stress ratings only. Stresses exceeding the range specified under “Absolute Maximum Ratings” may cause substantial damage to the device. Functional operation of this device at other conditions beyond those listed in the specification is not implied and prolonged exposure to extreme conditions may affect device reliability.

Note 1: In applications where high power dissipation and/or poor package thermal resistance is present, the maximum ambient temperature may have to be de-rated. Maximum ambient temperature (T_{A(max)}) is dependent on the maximum operating junction temperature [T_{J(max)}], the maximum power dissipation of the device in the application [P_{D(max)}], and the junction-to-ambient thermal resistance of the part/package in the application (q_{JA}), as given by the following equation: $T_A(\max) = T_J(\max) - (q_{JA} \times P_D(\max))$

THERMAL INFORMATION

Thermal Metric	WS4665 DFN2x2-8L	Units
q _{JA} Junction-to-ambient thermal resistance	62	°C/W

RECOMMENDED OPERATING CONDITIONS

Symbol	Parameter	MIN	MAX	UNIT	
V _{IN}	Input voltage range	0.8	V _{BIAS}	V	
V _{BIAS}	Bias voltage range	2.5	5.5	V	
V _{ON}	ON voltage range	0	5.5	V	
V _{OUT}	Output voltage range		V _{IN}	V	
V _{IH}	High-level input voltage, ON	V _{BIAS} =2.5V to 5.5V	1.2	5.5	V
V _{IL}	Low-level input voltage, ON	V _{BIAS} =2.5V to 5.5V	0	0.4	V
C _{IN}	Input capacitor	1		μF	

ELECTRICAL CHARACTERISTICS

Unless otherwise noted, the specification in the following table applies over the operating ambient temperature $-40^{\circ}\text{C} \leq T_A \leq 85^{\circ}\text{C}$ and $V_{\text{BIAS}}=5.0\text{V}$. Typical values are for $T_A=25^{\circ}\text{C}$.

Parameter	Test Conditions	T_A	Min	Typ	Max	Unit
Power Supplies and Currents						
$I_{\text{IN(VBIAS-ON)}}$ V_{BIAS} quiescent current	$I_{\text{OUT}} = 0\text{mA}$, $V_{\text{IN}} = V_{\text{ON}} = 5.0\text{V}$	Full		66	75	μA
$I_{\text{IN(VBIAS-OFF)}}$ V_{BIAS} shutdown current	$V_{\text{ON}} = \text{GND}$, $V_{\text{OUT}} = 0\text{V}$	Full			0.01	μA
$I_{\text{IN(VIN-OFF)}}$ V_{IN} off-state supply current	$V_{\text{ON}} = \text{GND}$, $V_{\text{OUT}} = 0\text{V}$	Full	$V_{\text{IN}} = 5.0\text{V}$	0.002	0.7	μA
			$V_{\text{IN}} = 3.3\text{V}$	0.001	0.5	
			$V_{\text{IN}} = 1.8\text{V}$	0	0.4	
			$V_{\text{IN}} = 0.8\text{V}$	0	0.3	
I_{ON} ON pin input leakage current	$V_{\text{ON}} = 5.5\text{V}$	Full			0.01	μA
Resistance Characteristics						
R_{ON} ON-state resistance	$I_{\text{OUT}} = -200\text{mA}$, $V_{\text{BIAS}} = 5.0\text{V}$	$V_{\text{IN}} = 5.0\text{V}$	25°C	14.2		$\text{m}\Omega$
			Full		22	
		$V_{\text{IN}} = 3.3\text{V}$	25°C	14.2		$\text{m}\Omega$
			Full		21.5	
		$V_{\text{IN}} = 1.8\text{V}$	25°C	14.2		$\text{m}\Omega$
			Full		21.5	
		$V_{\text{IN}} = 1.5\text{V}$	25°C	14.2		$\text{m}\Omega$
			Full		21	
		$V_{\text{IN}} = 1.2\text{V}$	25°C	14.2		$\text{m}\Omega$
			Full		21	
		$V_{\text{IN}} = 0.8\text{V}$	25°C	14.2		$\text{m}\Omega$
			Full		21	
R_{PD} Output pull-down resistance	$V_{\text{IN}} = 5.0\text{V}$, $V_{\text{ON}} = 0\text{V}$, $I_{\text{OUT}} = 15\text{mA}$	Full		230	250	Ω

ELECTRICAL CHARACTERISTICS (Continuous)

Unless otherwise noted, the specification in the following table applies over the operating ambient temperature $-40^{\circ}\text{C} \leq T_A \leq 85^{\circ}\text{C}$ and $V_{\text{BIAS}}=2.5\text{V}$. Typical values are for $T_A=25^{\circ}\text{C}$.

Parameter	Test Conditions	T_A	Min	Typ	Max	Unit
Power Supplies and Currents						
$I_{\text{IN(VBIAS-ON)}}$ V_{BIAS} quiescent current	$I_{\text{OUT}} = 0\text{mA}$, $V_{\text{IN}} = V_{\text{ON}} = 2.5\text{V}$	Full		35	45	μA
$I_{\text{IN(VBIAS-OFF)}}$ V_{BIAS} shutdown current	$V_{\text{ON}} = \text{GND}$, $V_{\text{OUT}} = 0\text{V}$	Full			0.01	μA
$I_{\text{IN(VIN-OFF)}}$ V_{IN} off-state supply current	$V_{\text{ON}} = \text{GND}$, $V_{\text{OUT}} = 0\text{V}$	Full	$V_{\text{IN}} = 2.5\text{V}$	0.001	0.5	μA
			$V_{\text{IN}} = 1.8\text{V}$	0.001	0.47	
			$V_{\text{IN}} = 1.2\text{V}$	0	0.41	
			$V_{\text{IN}} = 0.8\text{V}$	0	0.4	
I_{ON} ON pin input leakage current	$V_{\text{ON}} = 5.5\text{V}$	Full			0.01	μA
Resistance Characteristics						
R_{ON} ON-state resistance	$I_{\text{OUT}} = -200\text{mA}$, $V_{\text{BIAS}} = 2.5\text{V}$	$V_{\text{IN}} = 2.5\text{V}$	25°C	16		$\text{m}\Omega$
			Full		22	
		$V_{\text{IN}} = 1.8\text{V}$	25°C	15.7		$\text{m}\Omega$
			Full		21.7	
		$V_{\text{IN}} = 1.5\text{V}$	25°C	15.6		$\text{m}\Omega$
			Full		21.5	
		$V_{\text{IN}} = 1.2\text{V}$	25°C	15.6		$\text{m}\Omega$
			Full		21.4	
		$V_{\text{IN}} = 0.8\text{V}$	25°C	15.5		$\text{m}\Omega$
			Full		21.3	
R_{PD} Output pull-down resistance	$V_{\text{IN}} = 2.5\text{V}$, $V_{\text{ON}} = 0\text{V}$, $I_{\text{OUT}} = 1\text{mA}$	Full		255	270	Ω

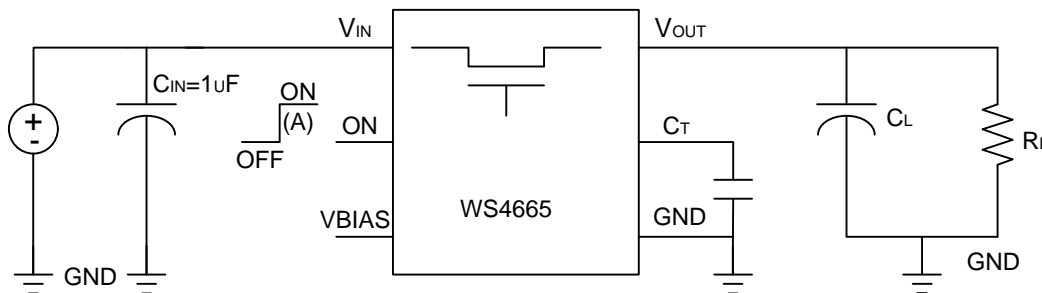
SWITCHING CHARACTERISTICS MEASUREMENT INFORMATION

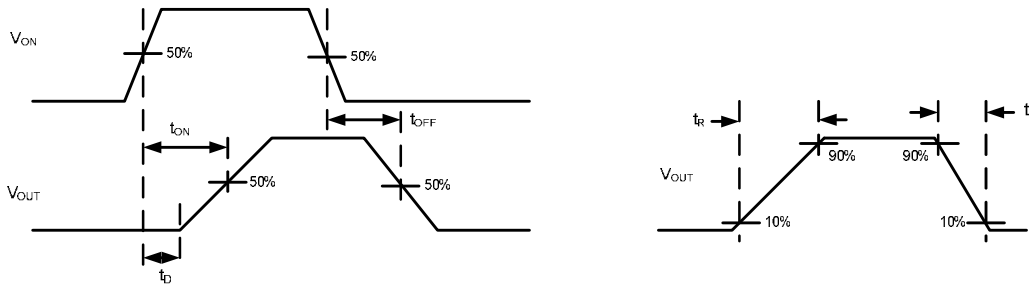
TEST CIRCUIT

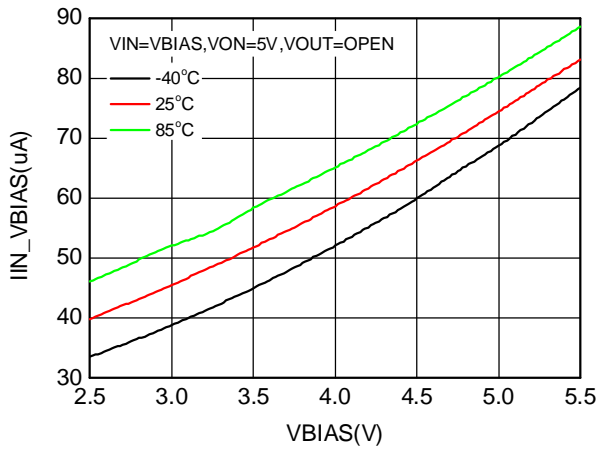
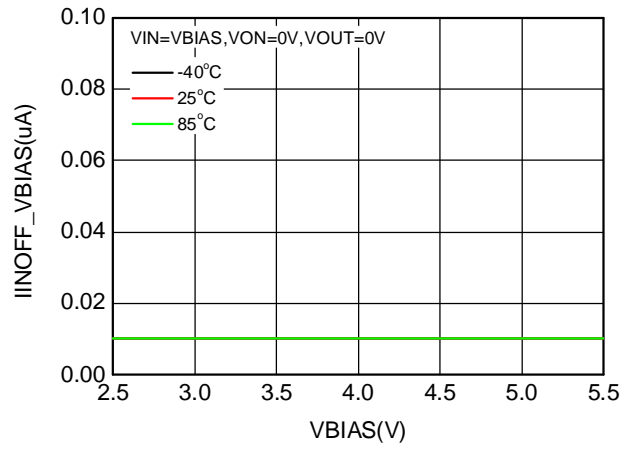
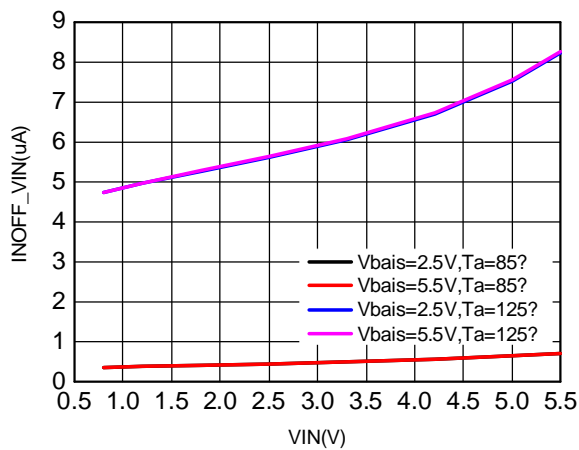
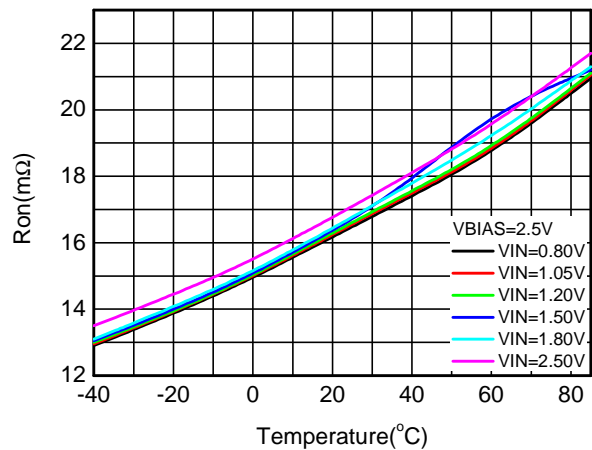
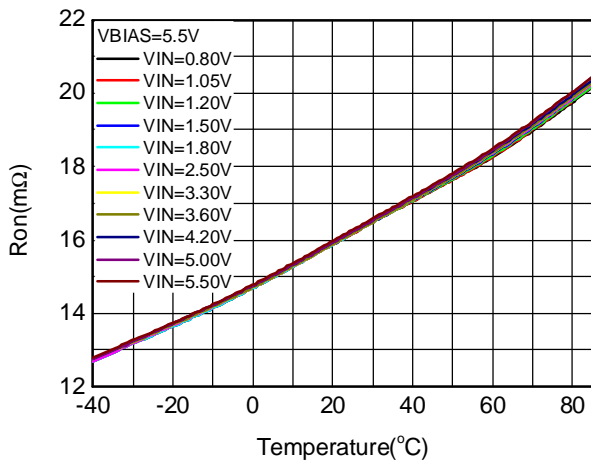
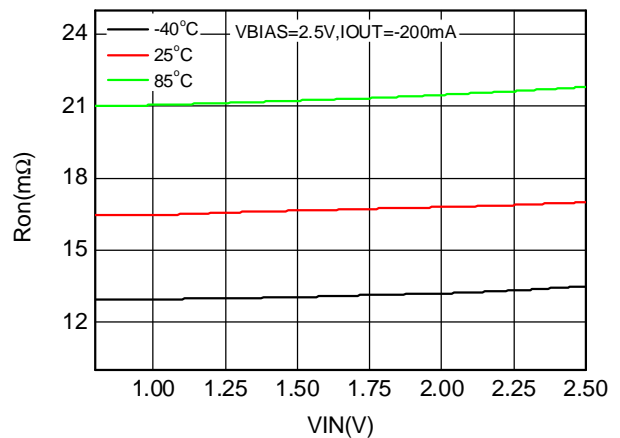

ton/toff WAVEFORMS
SWITCHING CHARACTERISTICS

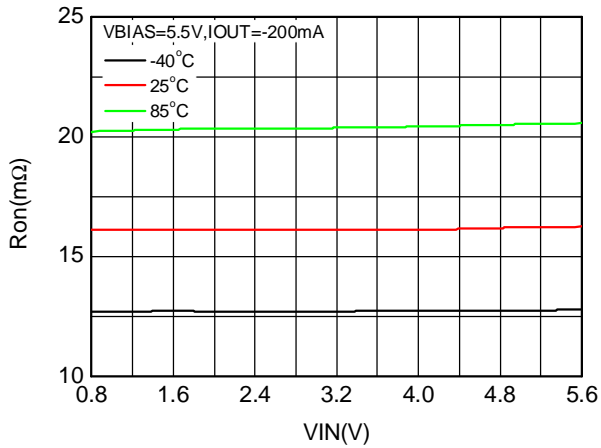
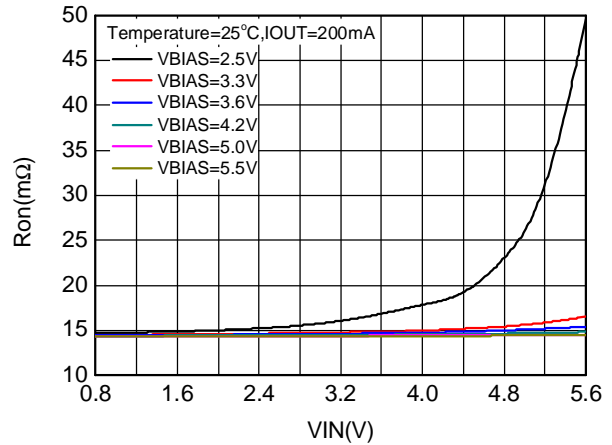
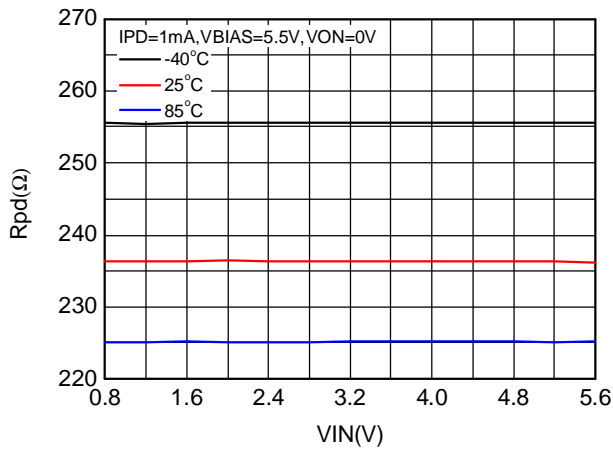
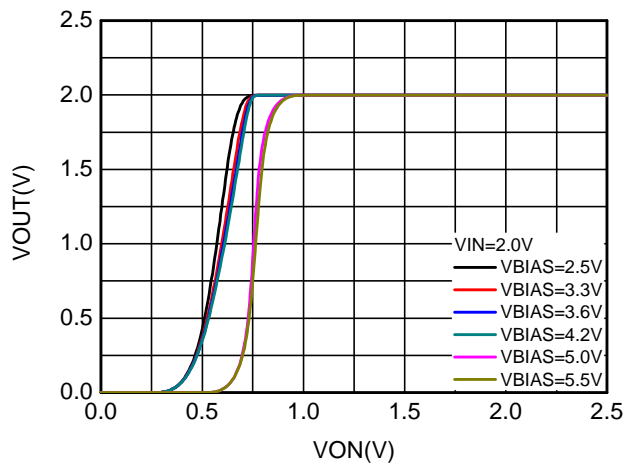
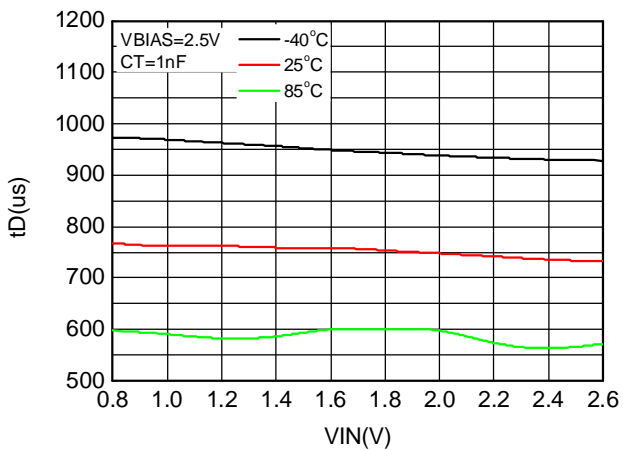
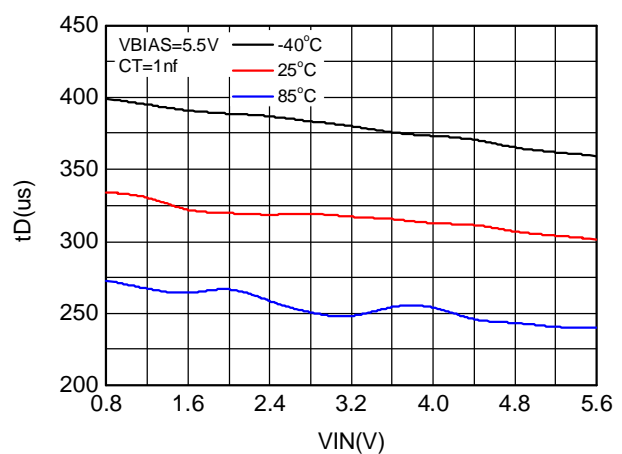
PARAMETER	TEST CONDITION	MIN	TYP	MAX	UNIT
$V_{IN} = V_{ON} = V_{BIAS} = 5V, T_A = 25\text{ }^\circ\text{C}$ (unless otherwise noted)					
t_{ON} Turn-on time	RL = 10Ω, CL = 0.1uF, CT = 1000pF		1380		μs
t_{OFF} Turn-off time			15		
t_R V_{OUT} rise time			2236		
t_F V_{OUT} fall time			5		
t_D ON delay time			322		
$V_{IN} = 0.8V, V_{ON} = V_{BIAS} = 5V, T_A = 25\text{ }^\circ\text{C}$ (unless otherwise noted)					
t_{ON} Turn-on time	RL = 10Ω, CL = 0.1uF, CT = 1000pF		550		μs
t_{OFF} Turn-off time			76		
t_R V_{OUT} rise time			290		
t_F V_{OUT} fall time			6		
t_D ON delay time			363		
$V_{IN} = 2.5V, V_{ON} = 5V, V_{BIAS} = 2.5V, T_A = 25\text{ }^\circ\text{C}$ (unless otherwise noted)					
t_{ON} Turn-on time	RL = 10Ω, CL = 0.1uF, CT = 1000pF		2226		μs
t_{OFF} Turn-off time			22		
t_R V_{OUT} rise time			2544		
t_F V_{OUT} fall time			4.9		
t_D ON delay time			720		
$V_{IN} = 0.8V, V_{ON} = 5V, V_{BIAS} = 2.5V, T_A = 25\text{ }^\circ\text{C}$ (unless otherwise noted)					
t_{ON} Turn-on time	RL = 10Ω, CL = 0.1uF, CT = 1000pF		1200		μs
t_{OFF} Turn-off time			72		
t_R V_{OUT} rise time			856		
t_F V_{OUT} fall time			6.1		
t_D ON delay time			736		

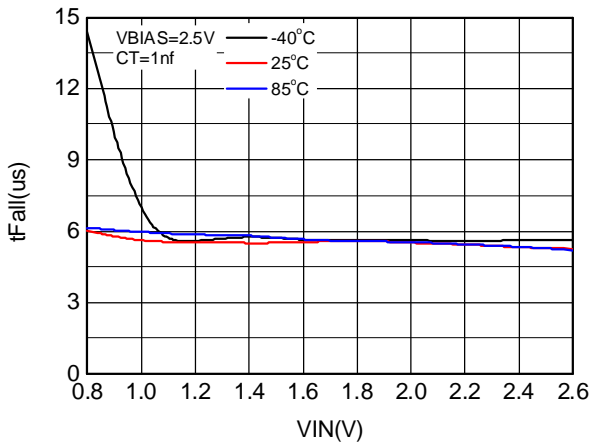
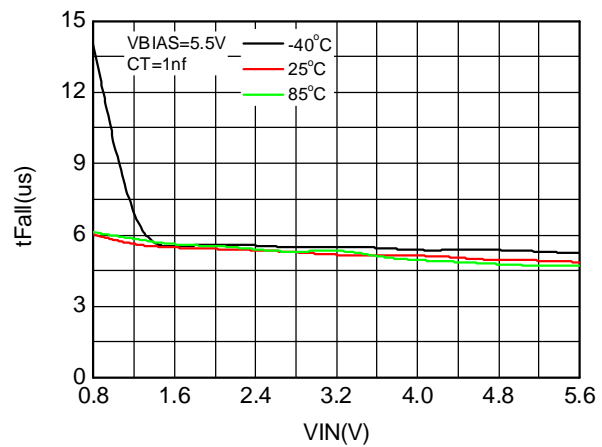
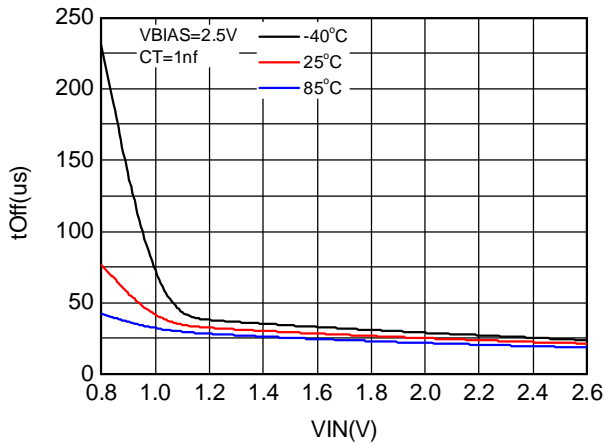
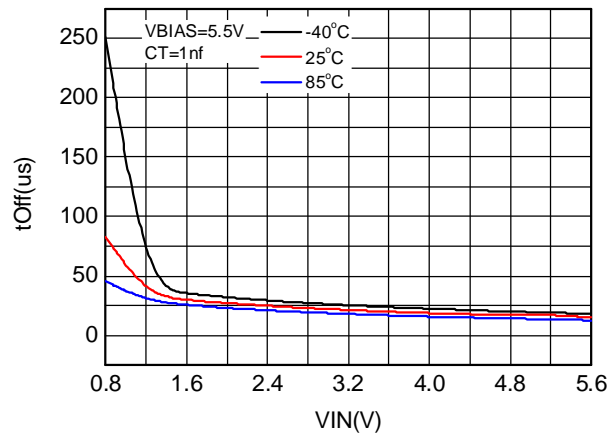
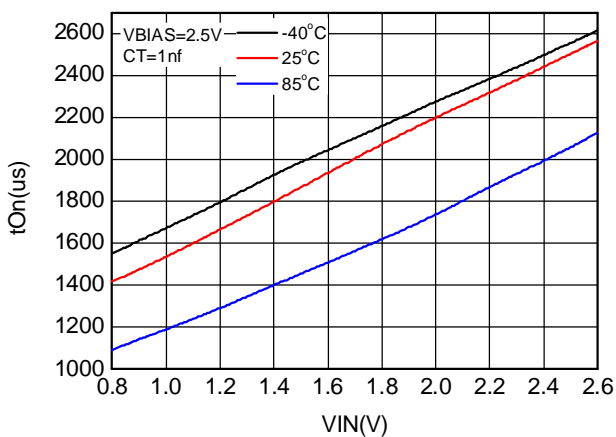
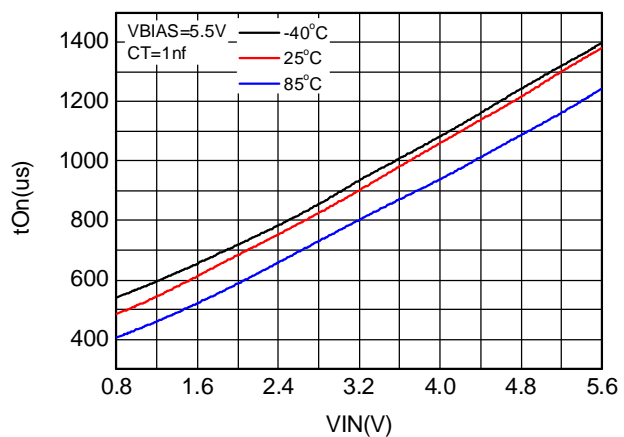
TYPICAL CHARACTERISTICS (Ta=25°C, unless otherwise noted)

Quiescent Current vs. V_{BIAS}

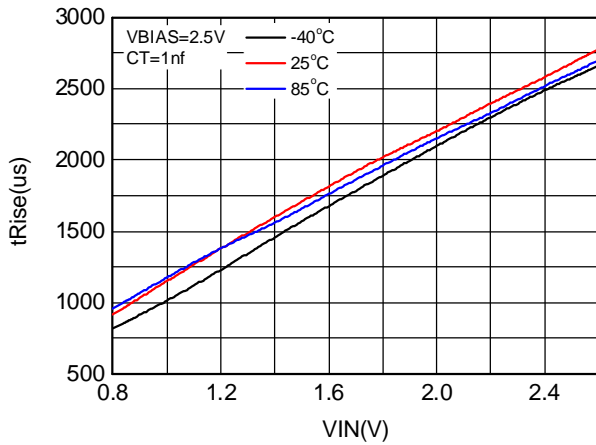
Shutdown Current vs. V_{BIAS}

OFF-State V_{IN} Current vs. V_{IN}

R_{ON} vs. TEMPERATURE (V_{BIAS} = 2.5V)

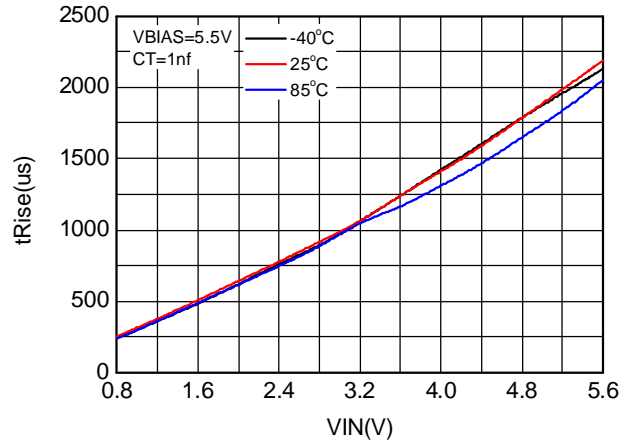
R_{ON} vs. TEMPERATURE (V_{BIAS} = 5.5V)

R_{ON} vs. TEMPERATURE (V_{BIAS} = 5.5V)

 R_{ON} vs. V_{IN} ($V_{BIAS} = 5.5V$)

 R_{ON} vs. V_{IN} ($T_A = 25^\circ C$)

 R_{PD} vs. V_{IN} ($V_{BIAS} = 5.5V$)

 V_{OUT} vs. V_{ON} ($T_A = 25^\circ C$)

 t_D vs. V_{IN} ($V_{BIAS} = 2.5V$, $CT=1nF$)

 t_D vs. V_{IN} ($V_{BIAS} = 5.5V$, $CT=1nF$)



 t_F vs. V_{IN} ($V_{BIAS} = 2.5V$, $CT=1nF$)

 t_F vs. V_{IN} ($V_{BIAS} = 5.5V$, $CT=1nF$)

 t_{OFF} vs. V_{IN} ($V_{BIAS} = 2.5V$, $CT=1nF$)

 t_{OFF} vs. V_{IN} ($V_{BIAS} = 5.5V$, $CT=1nF$)

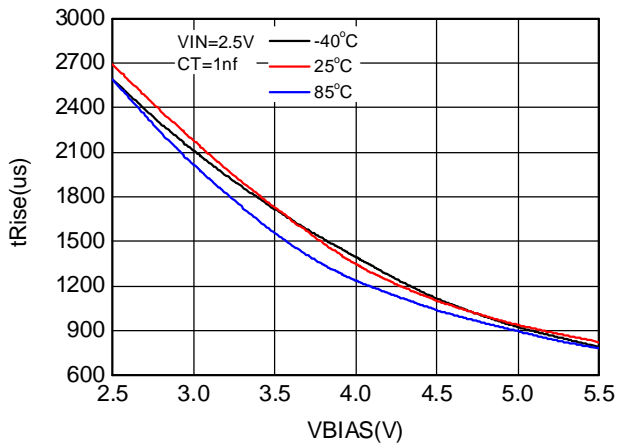
 t_{ON} vs. V_{IN} ($V_{BIAS} = 2.5V$, $CT=1nF$)

 t_{ON} vs. V_{IN} ($V_{BIAS} = 5.5V$, $CT=1nF$)



t_R vs. V_{IN} ($V_{BIAS} = 2.5V$, $CT=1nF$)



t_R vs. V_{IN} ($V_{BIAS} = 5.5V$, $CT=1nF$)

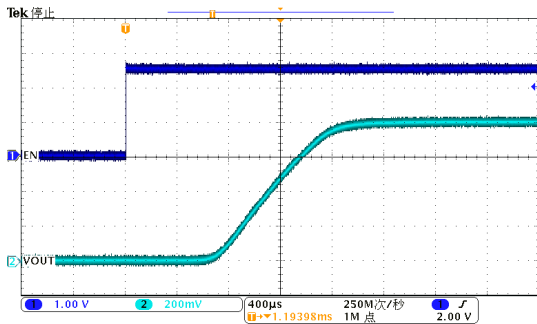
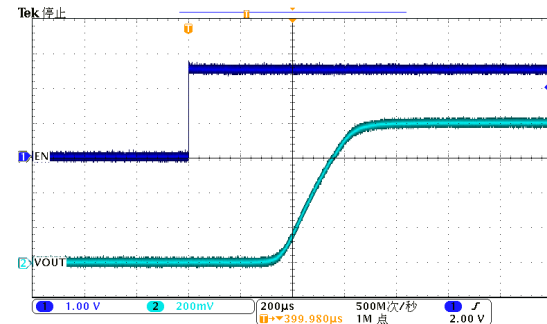
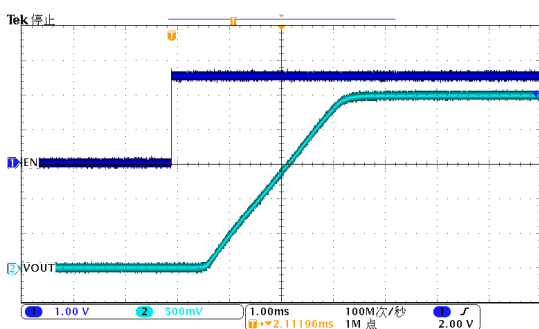
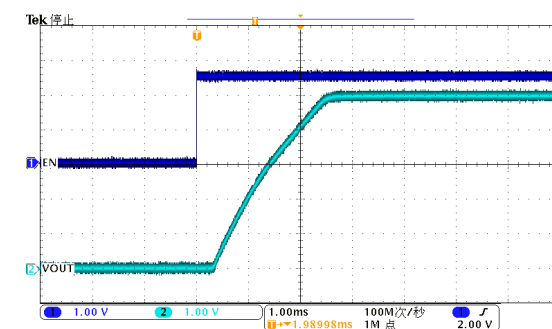
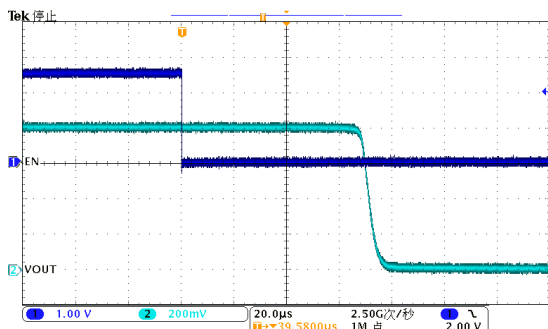
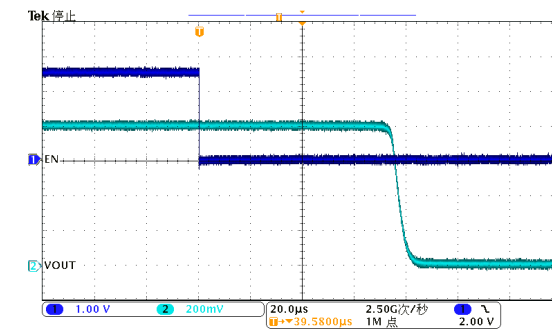
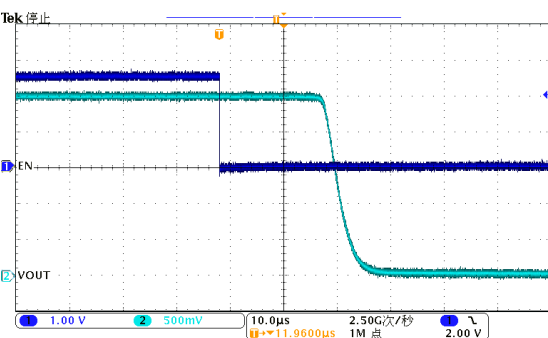
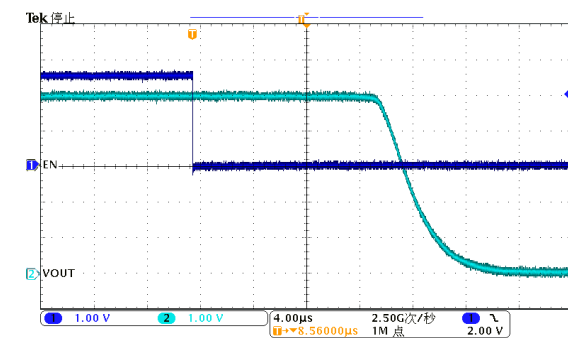

t_R vs. V_{BIAS} ($V_{IN} = 2.5V$, $CT=1nF$)

TYPICAL AC SCOPE CAPTURES at TA=25°C, CT=1nF (CH1=ON, CH2=VOUT)
TURN-ON RESPONSE TIME
 $(V_{IN}=0.8V, V_{BIAS}=2.5V, C_{IN}=1\mu F, C_L=0.1\mu F, R_L=10\Omega)$

TURN-ON RESPONSE TIME
 $(V_{IN}=0.8V, V_{BIAS}=5.0V, C_{IN}=1\mu F, C_L=0.1\mu F, R_L=10\Omega)$

TURN-ON RESPONSE TIME
 $(V_{IN}=2.5V, V_{BIAS}=2.5V, C_{IN}=1\mu F, C_L=0.1\mu F, R_L=10\Omega)$

TURN-ON RESPONSE TIME
 $(V_{IN}=5.0V, V_{BIAS}=5.0V, C_{IN}=1\mu F, C_L=0.1\mu F, R_L=10\Omega)$

TURN-OFF RESPONSE TIME
 $(V_{IN}=0.8V, V_{BIAS}=2.5V, C_{IN}=1\mu F, C_L=0.1\mu F, R_L=10\Omega)$

TURN-OFF RESPONSE TIME
 $(V_{IN}=0.8V, V_{BIAS}=5.0V, C_{IN}=1\mu F, C_L=0.1\mu F, R_L=10\Omega)$

TURN-OFF RESPONSE TIME
 $(V_{IN}=0.8V, V_{BIAS}=2.5V, C_{IN}=1\mu F, C_L=0.1\mu F, R_L=10\Omega)$

TURN-OFF RESPONSE TIME
 $(V_{IN}=0.8V, V_{BIAS}=5.0V, C_{IN}=1\mu F, C_L=0.1\mu F, R_L=10\Omega)$

APPLICATION INFORMATION

ON/OFF CONTROL

The ON pin controls the state of the switch. Asserting ON high enables the switch. ON is active high and has a low threshold, making it capable of interfacing with low-voltage signals. The ON pin is compatible with standard GPIO logic thresholds. It can be used with any microcontroller with 1.2V or higher GPIO voltage. This pin cannot be left floating and must be driven either high or low for proper functionality.

INPUT CAPACITOR (OPTIONAL)

To limit the voltage drop on the input supply caused by transient inrush currents when the switch turns on into a discharged load capacitor or short-circuit, a capacitor needs to be placed between VIN and GND. A 1- μ F ceramic capacitor, C_{IN} , placed close to the pins, is usually sufficient. Higher values of C_{IN} can be used to further reduce the voltage drop during high current applications. When switching heavy loads, it is recommended to have an input capacitor about 10 times higher than the output capacitor to avoid excessive voltage drop.

OUTPUT CAPACITOR (OPTIONAL)

Due to the integrated body diode in the NMOS switch, a C_{IN} greater than C_L is highly recommended. A C_L greater than C_{IN} can cause V_{OUT} to exceed V_{IN} when the system supply is removed. This could result in current flow through the body diode from VOUT to VIN. A C_{IN} to C_L ratio of 10 to 1 is recommended for minimizing V_{IN} dip caused by inrush currents during startup, however a 10 to 1 ratio for capacitance is not required for proper functionality of the device. A ratio smaller than 10 to 1 (such as 1 to 1) could cause slightly more VIN dip upon turn-on due to inrush currents. This can be mitigated by increasing the capacitance on the CT pin for a longer rise time (see ADJUSTABLE RISE TIME section below).

VIN AND VBIAS VOLTAGE RANGE

For optimal R_{ON} performance, make sure $V_{IN} \leq V_{BIAS}$. The device will still be functional if $V_{IN} > V_{BIAS}$ but it will exhibit R_{ON} greater than what is listed in the ELECTRICAL CHARACTERISTICS table. See below Figure for an example of a typical device. Notice the increasing R_{ON} as V_{IN} exceeds V_{BIAS} voltage. Be sure to never exceed the maximum voltage rating for VIN and VBIAS.

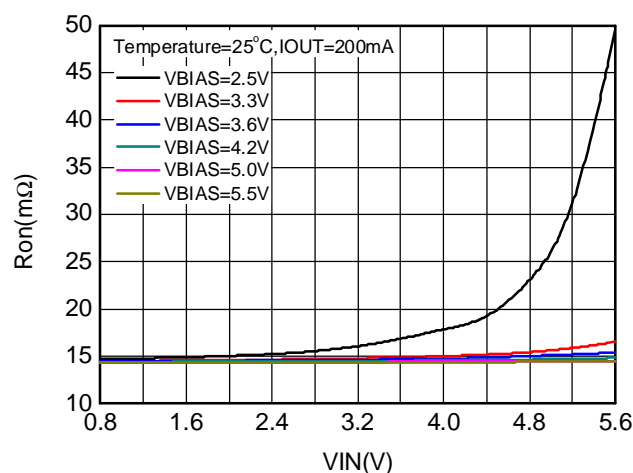

ADJUSTABLE RISE TIME

A capacitor to GND on the CT pin sets the slew rate. The voltage on the CT pin can be as high as 11V. Therefore, the minimum voltage rating for the CT cap should be 25V for optimal performance.

The table below contains rise time values measured on a typical device. Rise times shown below only valid for the power-up sequence where VIN and VBIAS are already in steady state condition, and the ON pin is asserted high.

CT(pF)	RISE TIME(us) 10%-90%, CL=0.1uF, CIN=1uF, RL=10Ω, VBIAS=5V TYPICAL VALUES at 25°C with a 25V X7R 10% CERAMIC CAPACITOR on CT								
	VIN=5V	VIN=4.2V	VIN=3.3V	VIN=2.5V	VIN=1.8V	VIN=1.5V	VIN=1.2V	VIN=1.05V	VIN=0.8V
0	195	170	132	107	85	76	67	62	54
220	410	340	254	193	145	125	106	97	81
470	1250	1000	728	526	376	314	254	224	178
1000	2220	1760	1260	928	656	550	440	396	306
2200	5060	4100	3020	2170	1550	1290	1040	910	684
4700	10320	8360	6280	4660	3320	2820	2280	2040	1600
10000	20500	16440	12120	8840	6280	5300	4320	3860	3040

BOARD LAYOUT AND THERMAL CONSIDERATIONS

For best performance, all traces should be as short as possible. To be most effective, the input and output capacitors should be placed close to the device to minimize the effects that parasitic trace inductances may have on normal operation. Using wide traces for V_{IN} , V_{OUT} , and GND helps minimize the parasitic effects along with minimizing the case to ambient thermal impedance.

The maximum IC junction temperature should be restricted to 125°C under normal operating conditions. To calculate the maximum allowable dissipation, $P_{D(max)}$ for a given output current and ambient temperature, use the following equation as a guideline:

$$P_{D(max)} = \frac{T_{J(max)} - T_A}{\theta_{JA}}$$

Where:

$P_{D(max)}$ = maximum allowable power dissipation

$T_{J(max)}$ = maximum allowable junction temperature (125 °C for the WS4665)

T_A = ambient temperature of the device

θ_{JA} = junction to air thermal impedance. See Thermal Information section. This parameter is highly dependent upon board layout.

In order to achieve smaller θ_{JA} , the copper area of V_{IN} and V_{OUT} pin on PCB should be as large as possible.

The figure below shows an example of a layout. Notice that the copper area connected to V_{IN} and V_{OUT} pin is big.

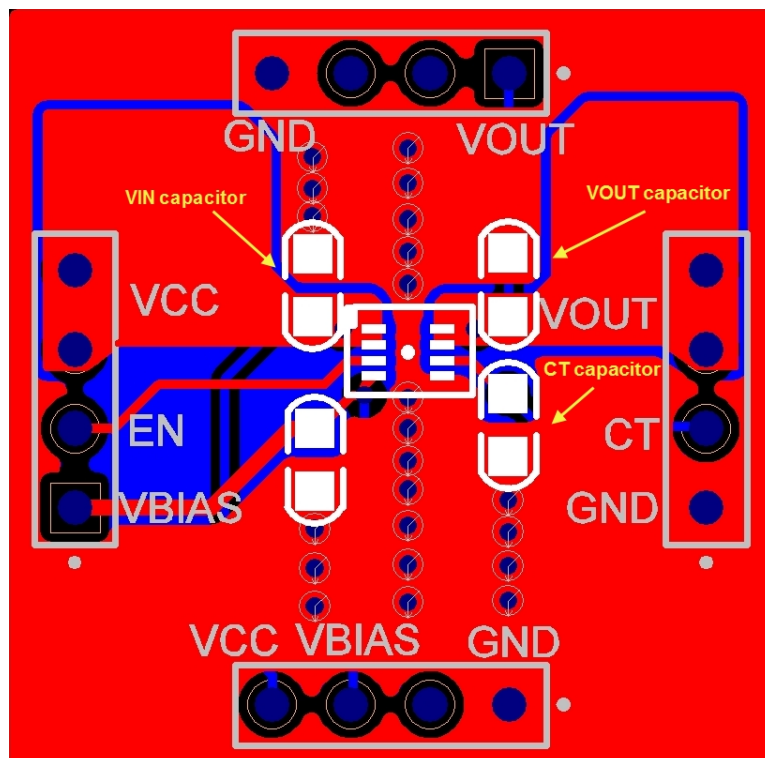

PACKAGE INFORMATION

DFNFC2×2-8L-D (P0.50T0.55) PACKAGE OUTLINE DIMENSIONS

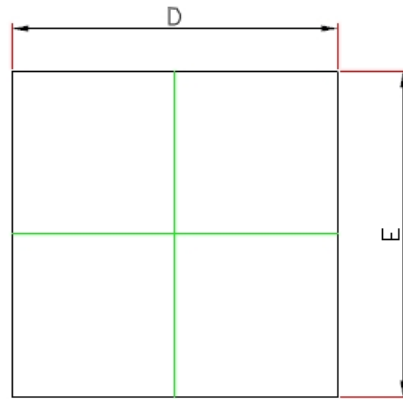
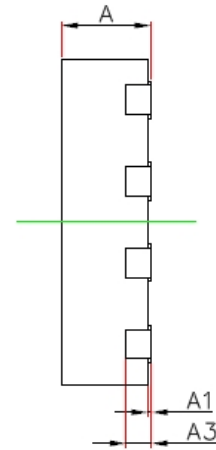
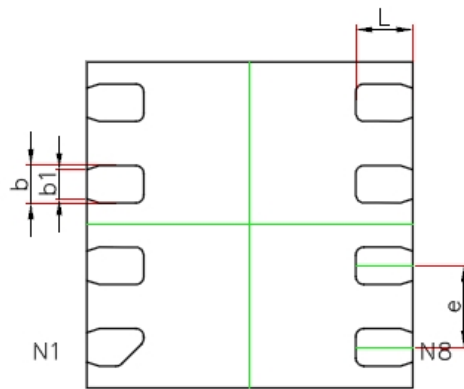
TOP VIEW

SIDE VIEW

BOTTOM VIEW

Symbol	Dimensions in millimeter		Min	Max
	Min	Max		
A	0.500	0.600	0.020	0.024
A1	0.000	0.050	0.000	0.002
A3	0.152REF.		0.006REF.	
D	1.900	2.100	0.075	0.083
E	1.900	2.100	0.075	0.083
b	0.200	0.300	0.008	0.012
b1	0.130	0.230	0.005	0.009
e	0.500TYP		0.020TYP	
L	0.300	0.400	0.012	0.016