

WS7938D

<http://www.sh-willsemi.com>

CMOS wide band LTE LNA

Descriptions

The WS7938D is a low noise amplifier (LNA) for LTE receiver applications, available in a small 6-pin DFN package. The WS7938D requires only one external inductor for input matching.

The WS7938D is designed to achieve low power dissipation and good performance. It is designed and optimized for the LTE medium and high band: 1805MHz to 2200MHz; 2300MHz to 2690MHz.

Features

- Operating frequency: 1805MHz to 2200MHz; 2300 MHz to 2690 MHz
- Noise figure = 1.0 – 1.3 dB
- Gain = 11.0 – 13.5 dB
- Input 1 dB compression point = -5.0 dBm
- In-band input IP3 = +4.0 dBm
- Supply voltage: 1.8 V to 3.1 V
- Integrated supply decoupling capacitor
- Supply current: 5.8 mA
- Power-down mode leakage current < 1 μ A
- One external matching inductor required
- Output decoupled to ground
- ESD protection: HBM > 2.0 kV for all pins
- Integrated output matching
- Package: 6-pin DFN, 1.1 x 0.7 x 0.55 mm³
- Process: CMOS

Applications

- Cell phones
- Tablets
- Other RF front-end modules

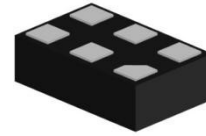

DFN1107-6L (Bottom view)

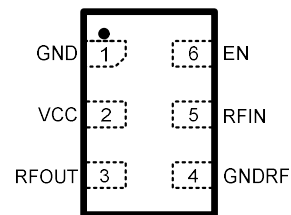

Pin configuration (Top view)

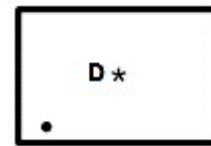

D = Device code
* = Month code (A~Z)

Marking (Top view)

Order information

Device	Package	Shipping
WS7938D-6/TR	DFN1107-6L	10000/Reel&Tape

Pinning information

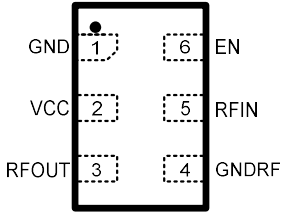
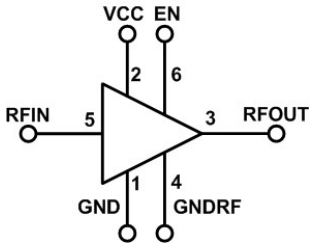
Pin	Description	Transparent top view	Symbol view
1	GND		
2	VCC		
3	RFOUT		
4	GNDRF		
5	RFIN		
6	EN		

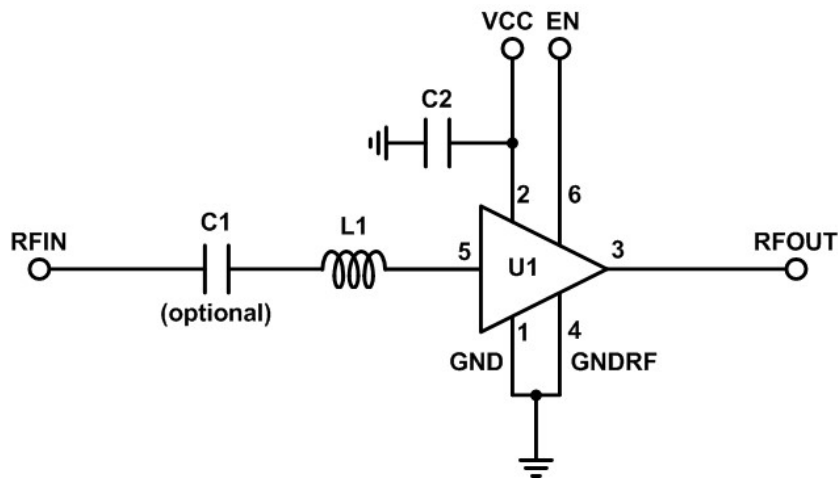
Application information

Symbol	Description	Footprint	Value	Supplier	Comment
U1	WS7938D	1.1x0.7x0.55 mm ³	NA	Will-Semi	DUT
C1	Capacitor	0402	1 nF	Various	DC blocking
C2	Capacitor	0402	1 nF	Various	Supply decoupling
L1	Inductor	0402	6.2 nH	Murata LQW15	Input matching

Quick reference data

freq = 2350 MHz; $V_{CC} = 2.8\text{ V}$; $V_{EN} > 2V_{CC}/3$; Temp = 25°C; input matched to 50Ω with a 6.2nH inductor. The condition is applied unless otherwise specified.

Symbol	Parameter	Condition	Min	Typ	Max	Unit
V_{CC}	Supply voltage		1.8	2.8	3.1	V
I_{CC}	Supply current			5.8		mA
G_p	Power gain			13.0		dB
NF	Noise figure			1.0		dB
IP_{1dB}	Input power at 1dB gain compression			-5.0		dBm
IIP_3	Input third-order intercept point			+4.0		dBm

Recommended operating conditions

Symbol	Parameter	Condition	Min	Typ	Max	Unit
V_{CC}	Supply voltage		1.8		3.1	V
Temp	Ambient temperature		-40	+25	+85	°C
V_{EN}	Input voltage on pin 6 (EN)	OFF state		0	$V_{CC}/3$	V
		ON state	$2V_{CC}/3$	V_{CC}		V

Absolute maximum ratings

Maximum ratings are absolute ratings, exceeding only one of these values may cause irreversible damage to the integrated circuit.

Symbol	Parameter	Condition	Min	Max	Unit
V_{CC}	Supply voltage		-0.3	3.1	V
V_{EN}	Input voltage on pin EN		-0.3	3.1	V
V_{RFIN}	Input voltage on pin RFIN		-0.3	3.1	V
V_{RFOUT}	Input voltage on pin RFOUT		-0.3	3.1	V
P_{in}	RF input power			0	dBm
T_{STG}	Storage temperature		-65	+150	°C
T_J	Junction temperature			150	°C
V_{ESD}	ESD capability all pins	Human Body Model (HBM)		±2000	V

Characteristics

Freq = 1805MHz to 2200MHz, 2300MHz to 2690MHz; $V_{CC} = 2.8\text{ V}$; $V_{EN} > 2V_{CC}/3$; Temp = 25°C; input mated to 50 Ω with a 6.2 nH inductor; The condition is applied unless otherwise specified.

Symbol	Parameter	Conditions	Min	Typ	Max	Unit
I _{cc}	Supply current	On state		5.8		mA
		Off state			1	μA
G _p	Power gain	f = 1850 MHz		13.0		dB
		f = 2150 MHz		13.5		dB
		f = 2350 MHz		13.0		dB
		f = 2650 MHz		11.0		dB
RL _{in}	Input return loss	f = 1850 MHz		5.0		dB
		f = 2150 MHz		7.0		dB
		f = 2350 MHz		8.0		dB
		f = 2650 MHz		7.0		dB
RL _{out}	Output return loss	f = 1850 MHz		6.5		dB
		f = 2150 MHz		10.0		dB
		f = 2350 MHz		15.0		dB
		f = 2650 MHz		10.0		dB
ISL	Reverse isolation	f = 1850 MHz		35.0		dB
		f = 2150 MHz		34.0		dB
		f = 2350 MHz		34.0		dB
		f = 2650 MHz		33.5		dB
NF	Noise figure	f = 1850 MHz		1.1		dB
		f = 2150 MHz		1.0		dB
		f = 2350 MHz		1.0		dB
		f = 2650 MHz		1.3		dB
IP _{1dB}	Input power at 1 dB gain compression	f = 1850 MHz		-5.0		dBm
		f = 2150 MHz		-5.0		dBm
		f = 2350 MHz		-5.0		dBm
		f = 2650 MHz		-5.0		dBm
IIP ₃	Input third-order intercept point	f = 1850 MHz ^[1]		+4.0		dBm
		f = 2150 MHz ^[2]		+4.0		dBm
		f = 2350 MHz ^[3]		+4.0		dBm
		f = 2650 MHz ^[4]		+4.0		dBm
K	Rollett stability factor ^[5]		1			
t _{on}	Turn-on time				5	μs
t _{off}	Turn-off time				5	μs

[1] f₁ = 1840 MHz, f₂ = 1850 MHz, P_{in} = -25 dBm

[2] f₁ = 2140 MHz, f₂ = 2150 MHz, P_{in} = -25 dBm

[3] f₁ = 2340 MHz, f₂ = 2350 MHz, P_{in} = -25 dBm

[4] f₁ = 2640 MHz, f₂ = 2650 MHz, P_{in} = -25 dBm

[5] 10M~20GHz

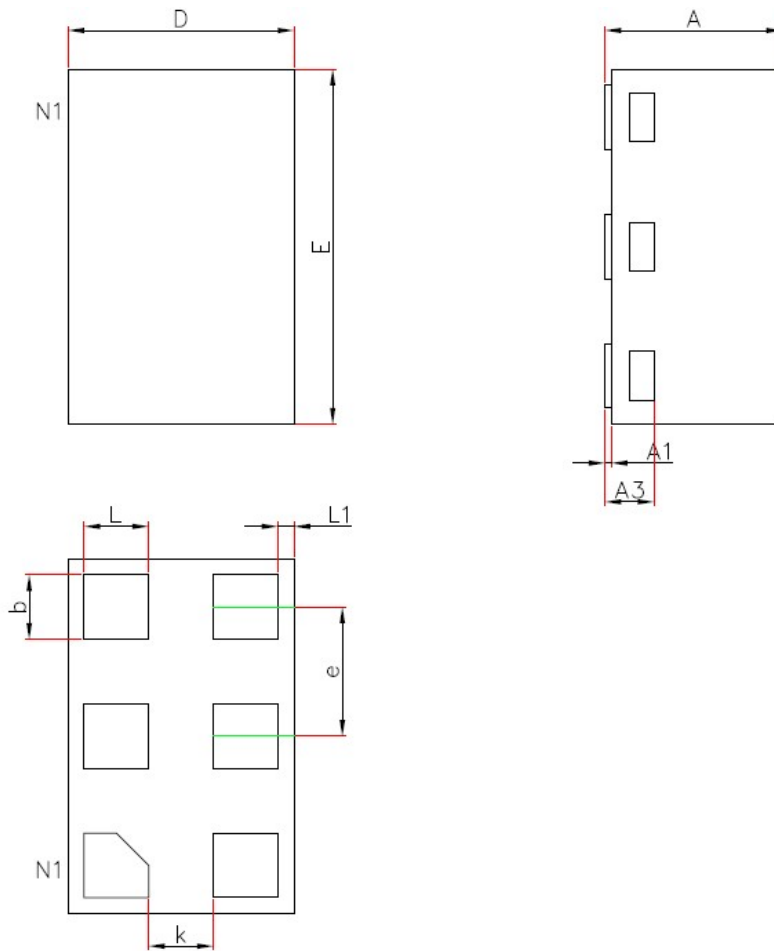
Package outline dimensions
DFN1107-6L

Symbol	Dimensions In Millimeters		
	Min.	Typ.	Max.
A	0.500	0.550	0.600
A1	0.000	0.025	0.050
A3	0.152REF		
b	0.150	0.200	0.250
D	0.600	0.700	0.800
E	1.000	1.100	1.200
e	0.400BSC		
k	0.200REF		
L	0.124	0.200	0.276
L1	0.050REF		

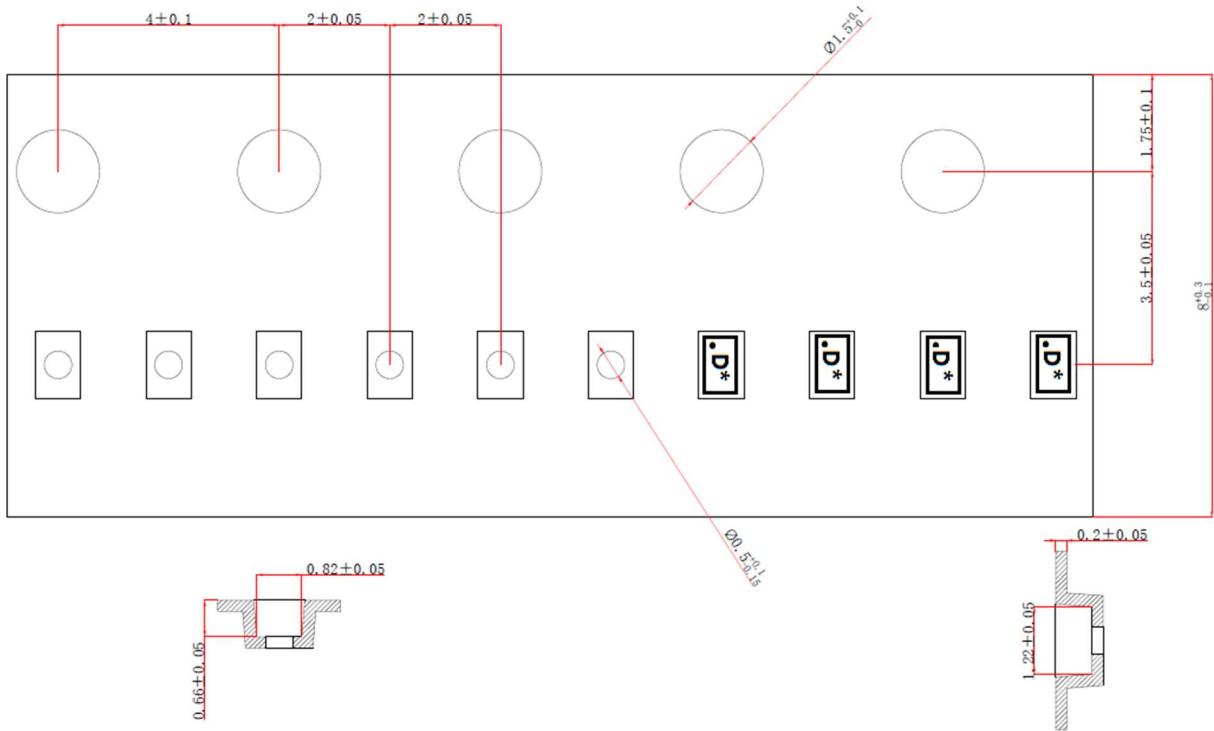
Tape & Reel dimensions

610 · 948 · 8499
CGP8 · 845 · 019
