

**Power Schottky Barrier Rectifier**
**Features**

- 2x10A average rectified forward current
- Low forward voltage and Low leakage current
- High Junction temperature
- High forward and reverse Surge capability

**Applications**

- High frequency switch model power supplies
- DC-DC Convertors, Power adapters

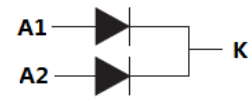
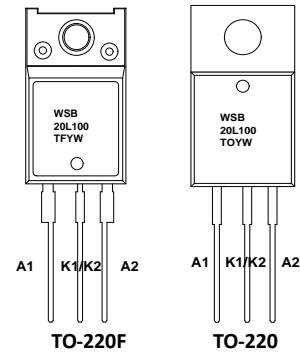

**Circuit**

**WSB20L100 = Device code**
**TO/TF = Special code**
**Y =Year**
**W =Week (A~z)**
**Marking**

<b>Absolute maximum ratings</b>				
<b>Parameter</b>		<b>Symbol</b>	<b>Value</b>	<b>Unit</b>
Reverse voltage (repetitive peak)		$V_{RM}$	100	V
Reverse voltage (DC)		$V_R$	100	V
Average rectified forward current	Per diode	$I_F$	10	A
	Per device	$I_F$	20	A
Non-Repetitive Peak Forward Surge Current 8.3ms Single Half Sine-Wave		$I_{FSM}$	200	A
Junction temperature		$T_J$	150	$^{\circ}C$
Operating temperature		$T_{opr}$	-55 ~ 150	$^{\circ}C$
Storage temperature		$T_{stg}$	-55 ~ 150	$^{\circ}C$
<b>Thermal Resistance Ratings</b>				
Maximum Thermal Resistance Junction To case (Per leg)	TO-220	$R_{JC}$	2.0	$^{\circ}C/W$

<b>Order information</b>			
<b>Device</b>	<b>Package</b>	<b>Marking</b>	<b>Units/Tube</b>
WSB20L100T-3/T	TO-220	WSB20L100TOYW	50
WSB20L100TF-3/T	TO-220F	WSB20L100TFYW	50

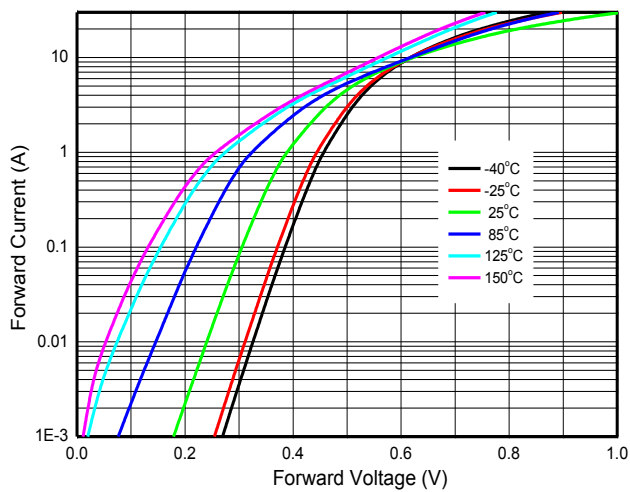
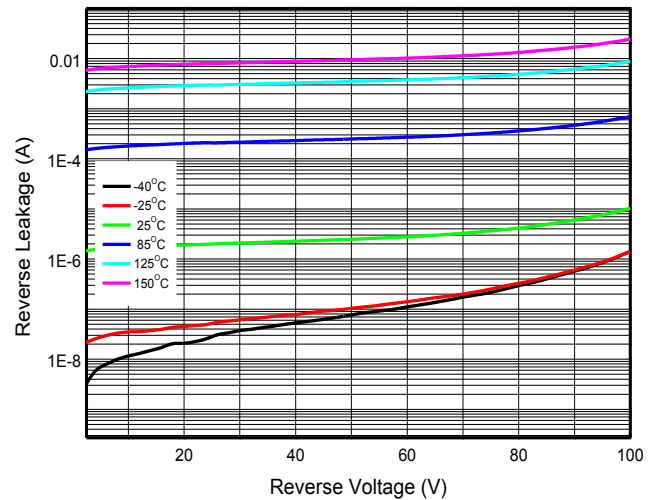
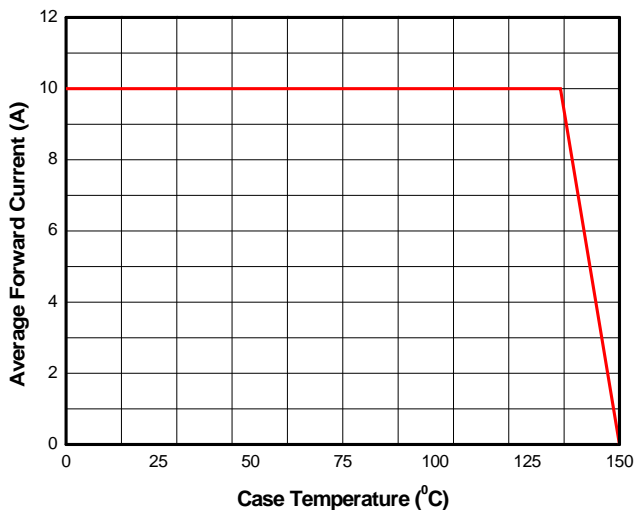
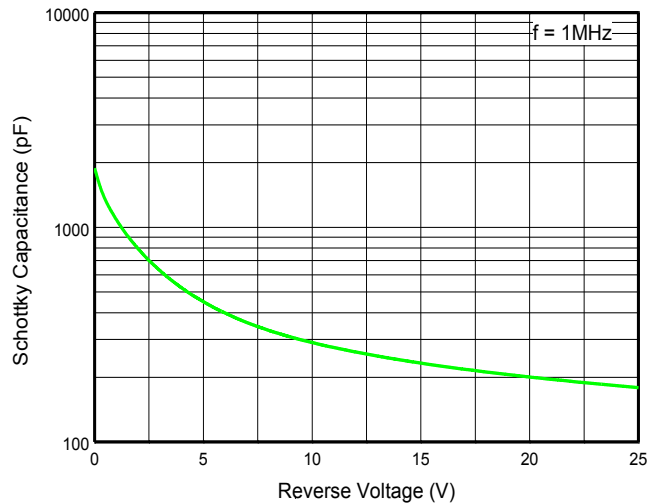
**Electronics characteristics (Per diode,  $T_A = 25^\circ\text{C}$ )**

Parameter	Symbol	Condition	Min.	Typ.	Max.	Unit
Reverse Breakdown Voltage	$V_R$	$I_R=0.5\text{mA}$	100			V
Forward voltage	$V_F$	$I_F=10\text{A}$		0.6	0.7	V
Reverse current	$I_R$	$V_R=100\text{V}$	-	11	100	$\mu\text{A}$
Junction capacitance	$C_J$	$V_R=25\text{V}, F=1\text{MHz}$	-	180		pF

**Typical characteristics ( $T_a=25^\circ\text{C}$ , unless otherwise noted)**

**Forward voltage vs. Forward current**

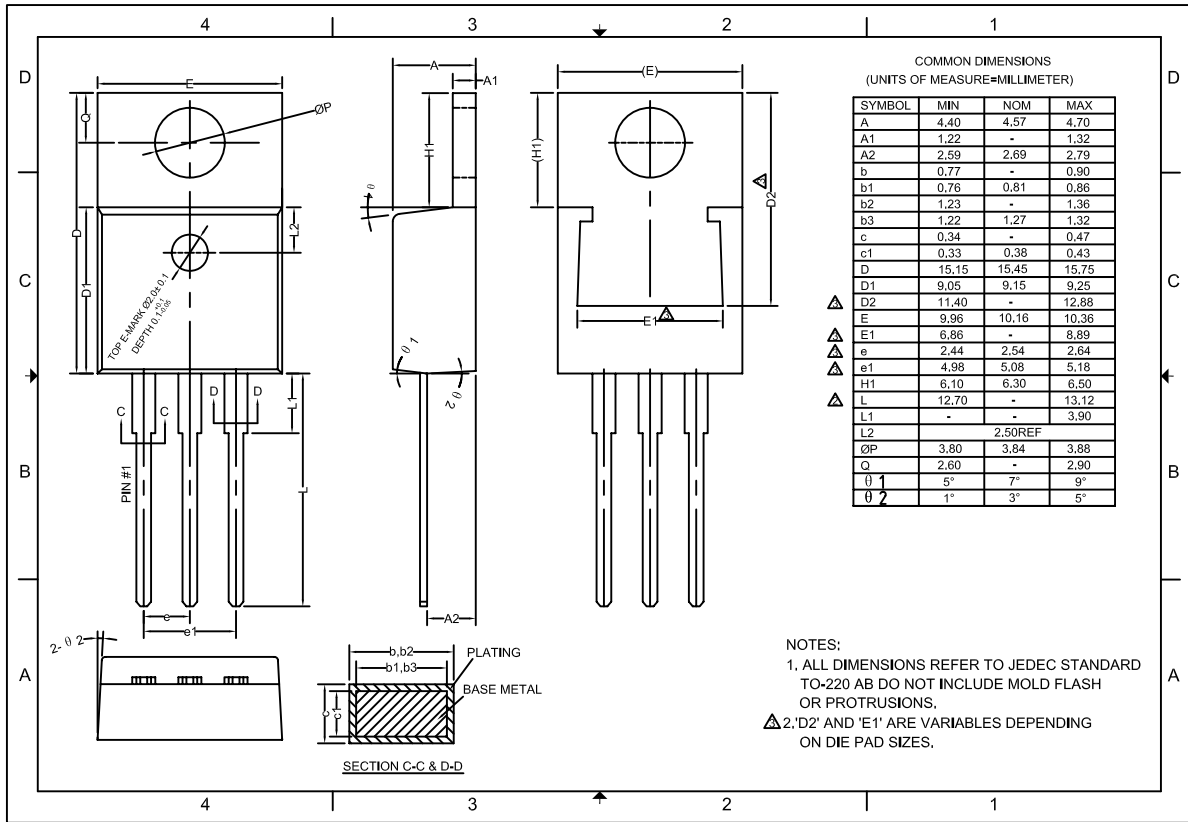
**Reverse current vs. Reverse voltage**

**Forward Current Derating Curve**

**Junction capacitance vs. Reverse voltage**

## Package outline dimensions

**TO-220**

**TO-220F**
