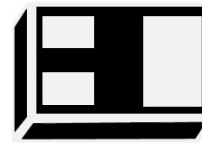
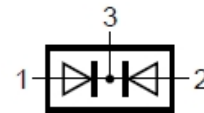


WSB5549N
Schottky Barrier Diode
[Http://www.willsemi.com](http://www.willsemi.com)
Features

- High switching speed
- Low leakage current
- Small package DFN1006-3L

Applications

- High-speed switching
- General-purpose switching


DFN1006-3L(Bottom View)

Circuit

Marking
Absolute maximum ratings

Parameter	Symbol	Value	Unit
Reverse voltage (repetitive peak)	V_{RM}	100	V
Reverse voltage (DC)	V_R	100	V
Average rectified forward current	I_O	150	mA
Peak forward surge current	I_{FSM}	1 ⁽¹⁾	A
Junction temperature	T_J	150	°C
Operating temperature	T_{opr}	-65 ~ 150	°C
Storage temperature	T_{stg}	-65 ~ 150	°C

Electronics characteristics ($T_A=25^\circ\text{C}$)

Parameter		Symbol	Condition	Min.	Typ.	Max.	Unit
Reverse Voltage	Per diode	V_R	$I_R=100\mu\text{A}$	100			V
Forward Voltage	Per diode	V_F	$I_F=1\text{mA}$			0.5	V
			$I_F=10\text{mA}$			0.6	V
			$I_F=50\text{mA}$			0.8	V
			$I_F=150\text{mA}$			1.2	V
Reverse current	Per diode	I_R	$V_R=25\text{V}$			50	nA
			$V_R=70\text{V}$			0.5	uA
			$V_R=100\text{V}$			1	uA
Junction capacitance		C_J	$V_R=5\text{V}, F=1\text{MHz}$		3.4		pF
Thermal Resistance		$R_{\theta(JA)}$	Junction to Ambient			500	K/W

Order Information

Device	Package	Marking	Shipping
WSB5549N-3/TR	DFN1006-3L	G*(2)	10000/Reel&Tape

Note 1: Pulse Width=1ms, Single Square Current;

Note 2: *= Month Code(A~Z); G= Device code;

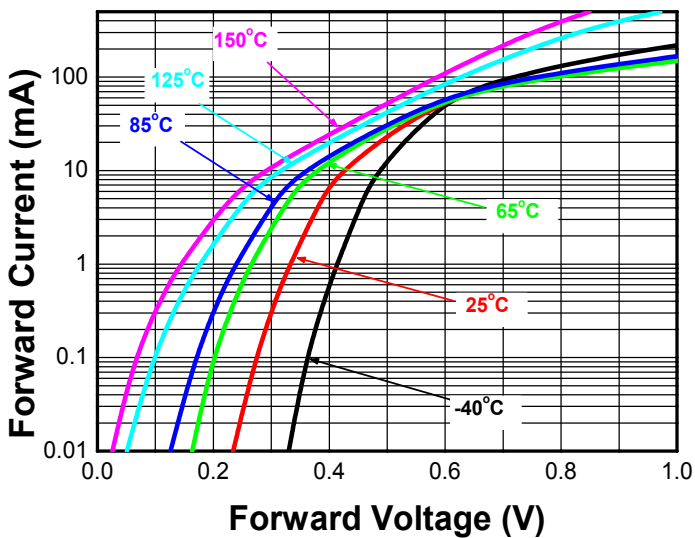
Typical characteristics (Ta=25°C, unless otherwise noted)


Fig.1 Forward voltage vs. Forward current

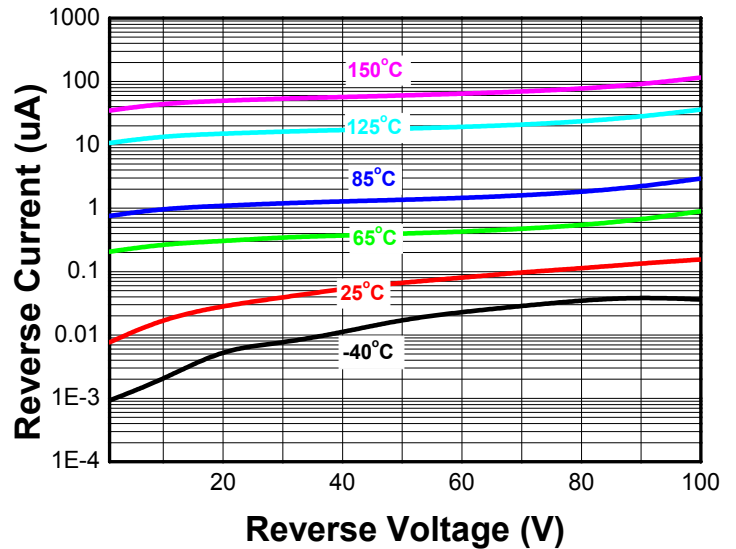


Fig.2 Reverse current vs. Reverse voltage

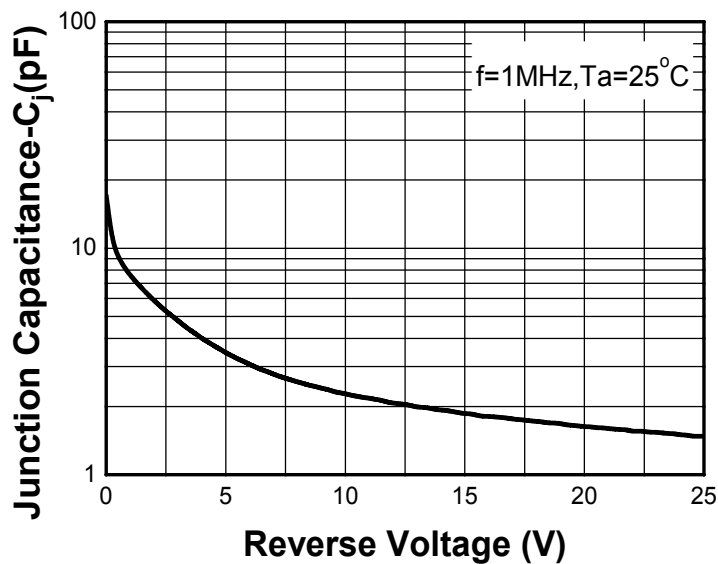
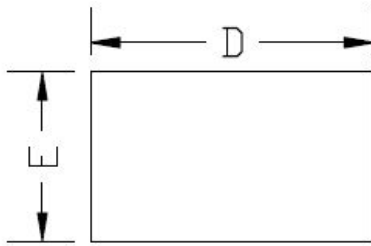
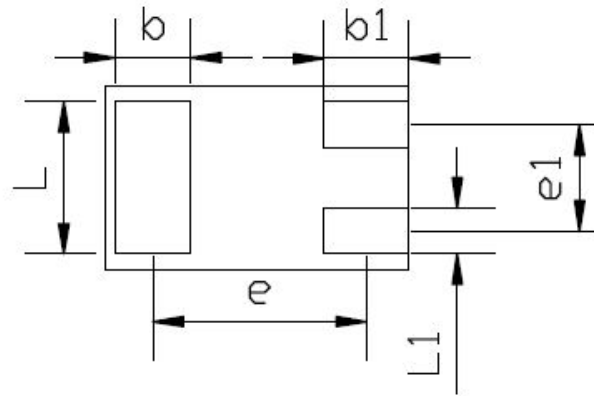
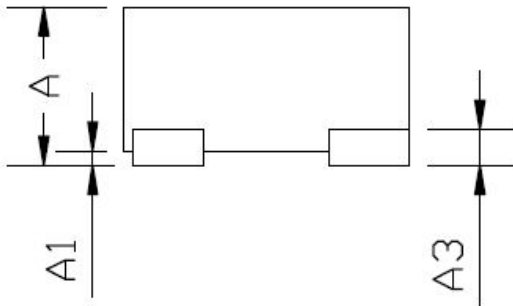
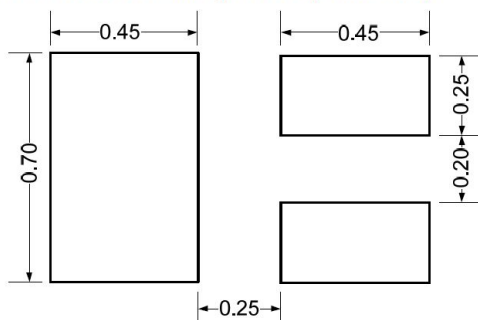


Fig.3 Junction capacitance vs. Reverse voltage

Package outline dimensions

TOP VIEW

BOTTOM VIEW

SIDE VIEW

COMMON DIMENSION (MM)			
PKG	DFN1006		
REF.	MIN.	NOM.	MAX
A	>0.4	-	0.50
A1	0.00	-	0.05
A3	0.125REF.		
D	0.95	1.00	1.05
E	0.55	0.60	0.65
b	0.20	0.25	0.30
b1	0.20	0.30	0.40
L	0.45	0.50	0.55
L1	0.10	0.15	0.20
e	0.675		
e1	0.35		

Recommend land pattern (Unit: mm)

Notes:

This recommended land pattern is for reference purposes only. Please consult your manufacturing group to ensure your PCB design guidelines are met.