



WSH41S

Hall Effect Sensor IC with Thermal Lock Protection ,Auto Restart and Speed Control Function

Features:

- Operate from 2.8V to 20V supply voltage.
- On-chip Hall sensor.
- Internal bandgap regulator allows temperature compensated operations and a wide operating voltage range.
- High output sinking capability up to 600mA for driving large load.
- Lower current change rate reduces the peak output voltages during switching.
- Available in rugged low profile SOT-25 packages.
- PS pin can accept PWM signal to program rotation speed.
- Built-in protection diode for reverse power supply fault.
- Built-in thermal lock protection and auto-restart function.

General Description:

WSH41S is designed to integrate Hall sensor with complementary output drivers and speed control function together on one chip, it is suitable for speed measurement, revolution counting, positioning, and DC brushless motors. It includes a temperature compensated voltage regulator, a differential amplifier, a Hysteresis controller, two open-collector output drivers capable of sinking 600mA current load and PS pin which can accept PWM signal to do speed control programming. An on-chip protection diode is implemented to prevent reverse power fault. And built-in thermal lock protection and auto-restart function is suitable for super high speed fan. It can replace the function of lock protection and auto restart function. The power will be shutdown automatically at 130°C to prevent the coils be damaged and auto-restart after cooling down.

The temperature-dependent bias increases the supply voltage of the hall plates and adjusts the switching points to the decreasing induction of magnets at higher temperatures. Subsequently, the open collector output switches to the appropriate state. WSH41S are rated for operation over temperature range from -20° C to 100°C and voltage ranges from 2.8V to 20V.

Pin Descriptions: SOT-25

Winson reserves the right to make changes to improve reliability or manufacturability.



WSH41S

Function Block:

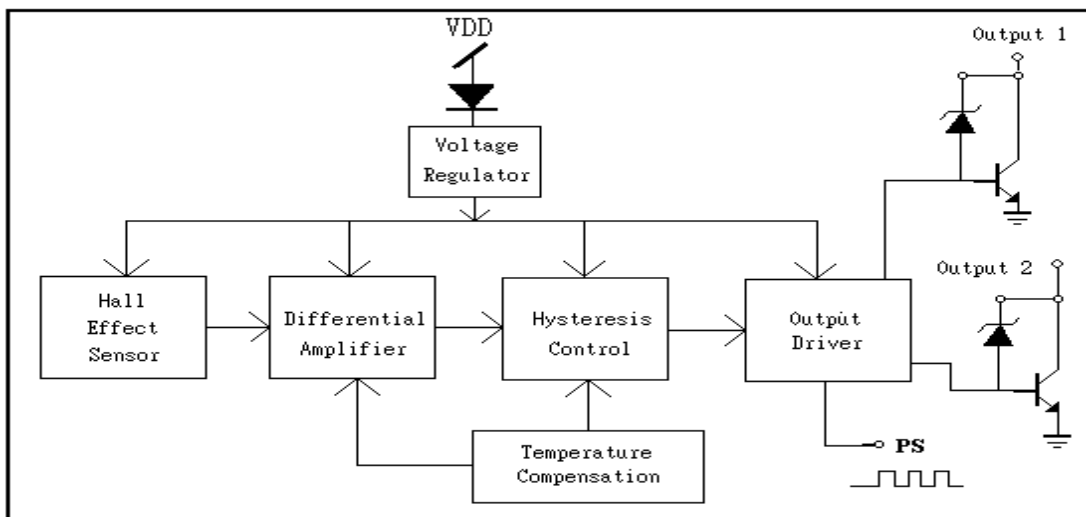

Magnetic Characteristics:

Characteristics	Symbol	Quantity	Ta= -20°C to +100°C			Unit
			Min	Typ.	Max	
Operate Point	Bop	Grade A		25	50	Gauss
		Grade B		30	70	
Release Point	Brp	Grade A	-50	-25		Gauss
		Grade B	-70	-30		
Hysteresis Window	Bop-Brp			40	200	Gauss

Ordering Information:

SOT- 25: WSH41S-XPD <input type="checkbox"/> 	Elec. Grade
	1: A Grade (50 Gauss) 2: B Grade (70 Gauss)

Winson reserves the right to make changes to improve reliability or manufacturability.

WSH41S Complementary Output1 vs. Output2/Vfg

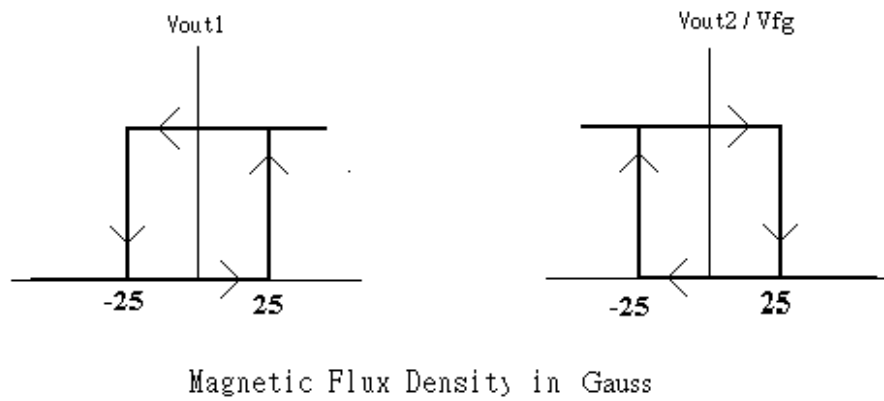

Test Circuit:

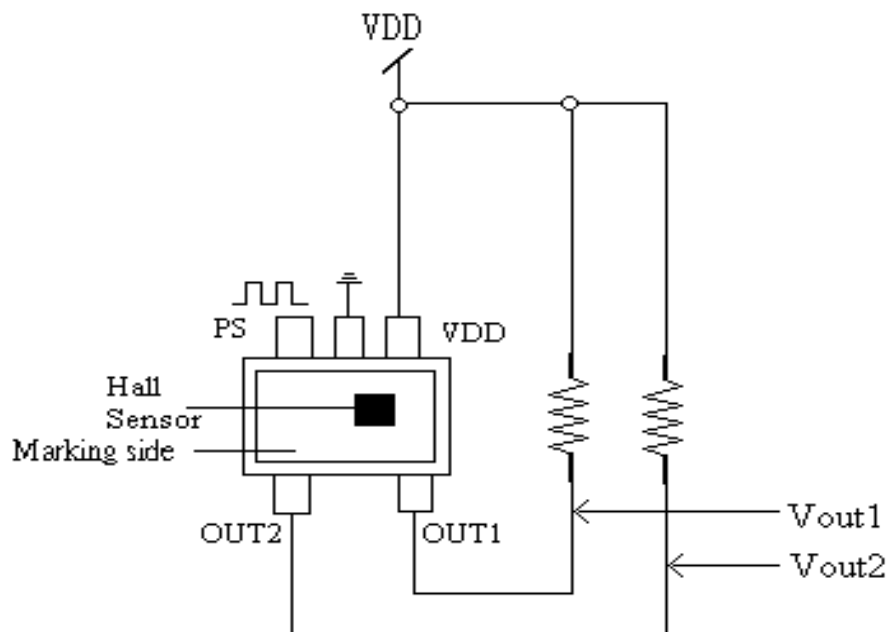

Winson reserves the right to make changes to improve reliability or manufacturability.



WSH41S

Package Information:

SOT-25

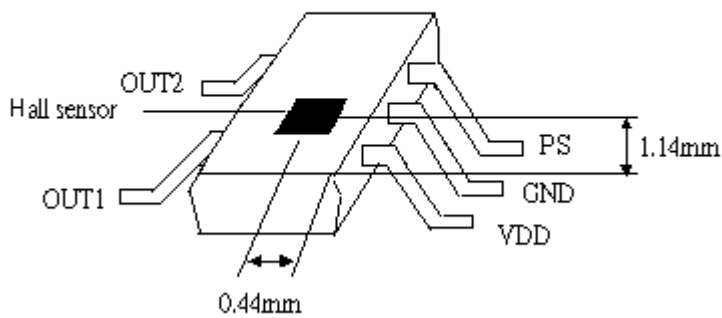
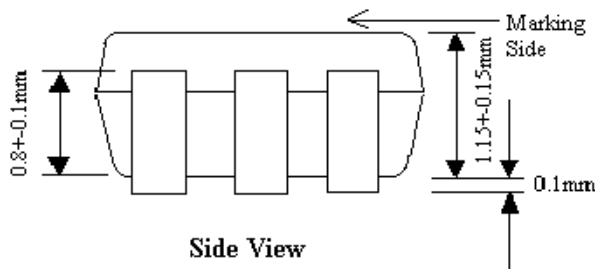
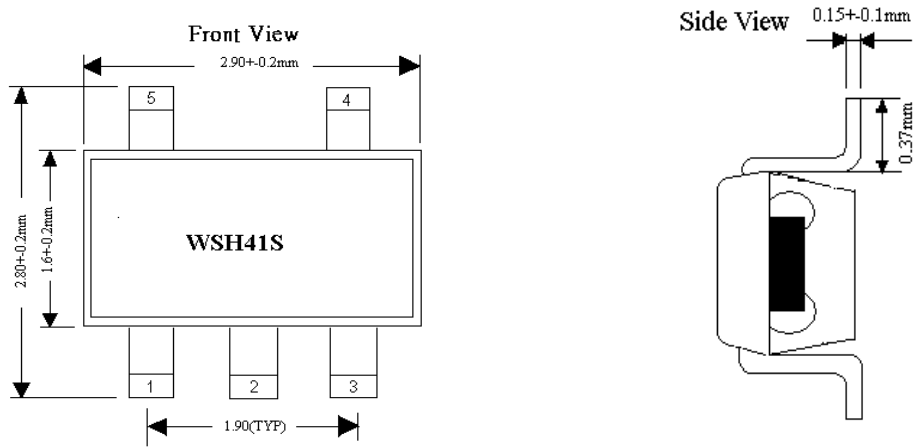

Winson reserves the right to make changes to improve reliability or manufacturability.



Application Circuit:

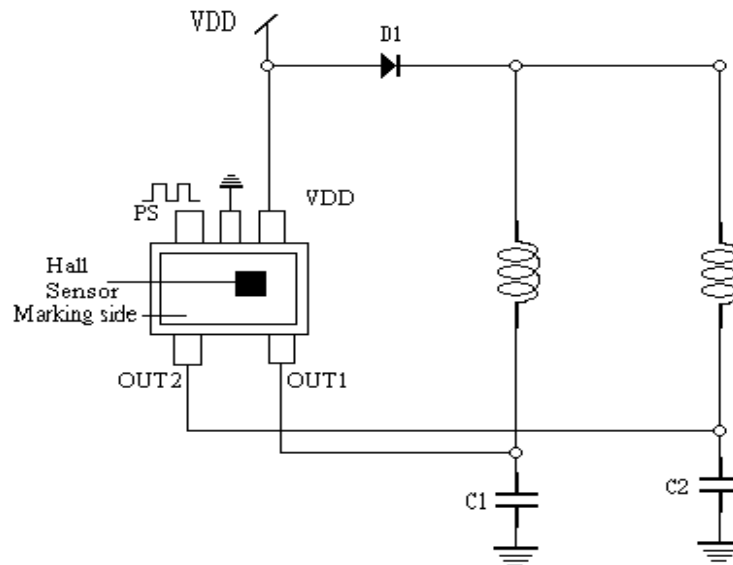

Figure 1.

WSH41S with power sleep function is designed for reducing power consumption and noise for smart cooling in various applications especially for portable computer systems while system processors are not in full loading.

1. **Green PC System:** PC and Notebook systems switch to sleep mode and start screen savor when CPU is in idle state. Mean while, system can apply an active low signal V_{PS} to enable WSH41S power sleep function which makes DC fans of CPU cooler and even VGA card stop running until CPU loading is heavy again in order to reduce unnecessary power consumption.
2. **CPU with Temperature Sensor Feature:** System can detect CPU junction temperature that reflects the CPU operating status. If CPU is not in heavy loading, junction temperature is not high enough to affect CPU operation, there is no need to start DC fan to consume extra power. System designer can simply program the system based on two CPU temperatures to apply a proper input signal to enable or disable WSH41S power sleep function. For example, when CPU junction temperature drops to point A (CPU is in idle state or lightly loading), system enables WSH41S power sleep function. At this point, DC fan stops running and consumes power as low as 2mA typically. If CPU junction temperature increases to

Winson reserves the right to make changes to improve reliability or manufacturability.

point B, system disables WSH41S power sleep function and DC fan starts running again to cool down CPU temperature. Most of the time, system processors are in idle state for most users. DC fans with power sleep function can save up to 98% of power when CPU is idle or even lightly loading.

Temperature-Dependent Hysteresis Window

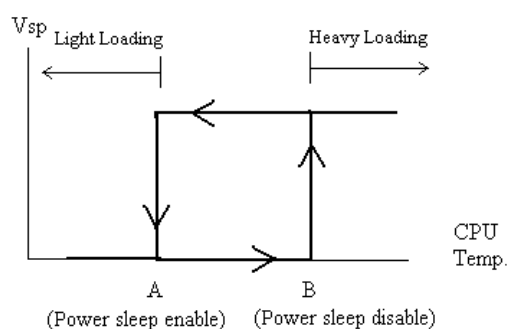

3. **Smart Cooling by Thermistor:** An alternative way to achieve thermal-controlled power sleep function is the use of a thermistor that is sensitive to the operating ambient temperature. The thermistor can be placed at the hottest spot of the system with very simple voltage divider circuit as shown below. System designer can select a proper thermistor to adjust V_{ps} level (V_{ps} switching level is approximate 1.8V) to enable/disable power sleep function based on the Temperature-Dependent Hysteresis Window shown above. In this application, the thermistor has a characteristic of negative temperature-dependent coefficient.

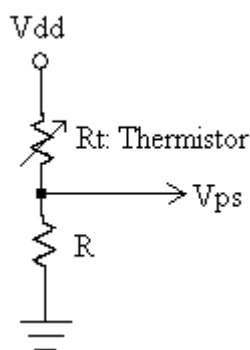

Winson reserves the right to make changes to improve reliability or manufacturability.



WSH41S

4. Speed Control: DC fan Speed Control can be programmed by applying a PWM signal to PS pin of WSH41S. For example, if PWM signal is programmed with pulse width of H/L ratio of 1/1 in a duty cycle, DC Fan consumes only 50% of power and revolution speed is approximately 50% of full speed. If PWM signal is programmed with pulse width of H/L ratio of 3/2 in a duty cycle, DC Fan consumes only 60% of power and revolution speed is approximately 60% of full speed and so on and so forth.

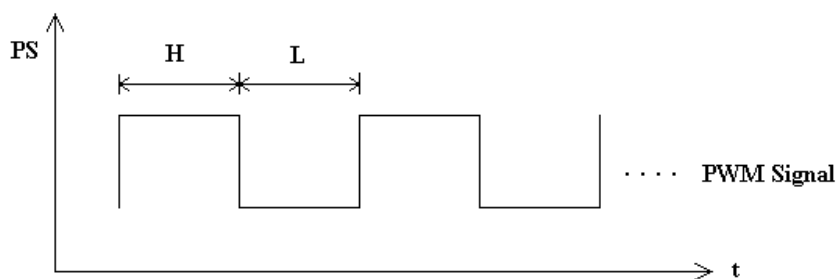

PWM Signal with pulse width of H/L ratio

It is recommended to apply a “H” (>1.8V) or a “L” (<0.6V) signal to the PS input pin to activate the power sleep circuit.

Sleep Mode: $V_{PS} = \text{“L”}$ (<0.6V)

Normal Operation: $V_{PS} = \text{“H”}$ (>1.8V)

Winson reserves the right to make changes to improve reliability or manufacturability.