

High Voltage NPN Power Transistor with Diode

Features

- High Voltage
- BV_{CEO} : 400V
- BV_{CBO} : 800V
- I_c : 1.5A
- Silicon Triple Diffused Type
- NPN Silicon Transistor with Diode
- Free-wheeling Diode Inside
- Low Variable Storage-time Spread
- Low Base Drive Requirement
- Half Bridge Light Ballast Application



INTERNAL SCHEMATIC DIAGRAM

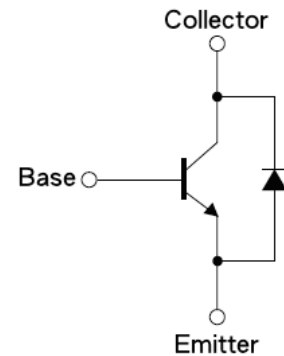

Application

- Electronic Ballasts
- Adapter
- Lighting

ABSOLUTE MAXIMUM RATINGS ($T_c = 25^{\circ}\text{C}$)

Parameter	Symbol	Max rating	Unit
Collector-Base Voltage	V_{CBO}	800	V
Collector-Emitter Voltage	V_{CEO}	400	V
Emitter-Base Voltage	V_{EBO}	10	V
Collect Current	I_c	1.5	A
Collector Peak Current ($t_p < 5\text{ms}$)	I_{CM}	3	A
Base Current	I_B	1	A
Base Peak Current ($t_p < 5\text{ms}$)	I_{BM}	2	A
Total Power Dissipation @ $T_c \leq 25^{\circ}\text{C}$ (TO-251)	P_{tot}	30	W
Maximum Operating Junction Temperature	T_J	+150	$^{\circ}\text{C}$
Storage Temperature Range	T_{STG}	-65 ~ +150	$^{\circ}\text{C}$

ELECTRICAL CHARACTERISTICS (T_c = 25°C)

Parameter	Symbol	Test Condition	Min	Typ	Max	Unit
Collector-Base Voltage	BVCBO	IC = 1mA, IB=0	800	–	–	V
Collector-Emitter Breakdown Voltage	BVCEO	IC = 10mA, IE=0	400	–	–	V
Emitter- Base Breakdown Voltage	BVEBO	IE = 1mA, IC=0	10	–	–	V
Collector Cutoff Current	ICBO	VCB = 700V, IE=0	–	–	1	μA
Emitter Cutoff Current	IEBO	VEB = 9V, IC=0	–	–	1	μA
DC Current Gain	hFE1	VCE = 5V, IC=10mA	10	–	–	
	hFE2	VCE = 5V, IC=400mA	10	–	30	
	hFE3	VCE = 5V, IC=1A	5	–	–	
Collector-Emitter Saturation Voltage	VCE(SAT1)	IC = 0.5A, IB =0.1A	–	–	0.5	V
	VCE(SAT2)	IC = 1A, IB =0.25A	–	1.1	1.5	
Base-Emitter Saturation Voltage	VBE(SAT1)	IC = 0.5A, IB =0.1A	–	–	1.1	V
	VBE(SAT2)	IC = 1A, IB =0.25A	–	–	1.2	V

Resistive Load Switching Time (Ratings)

Turn On Time	t _{on}	V _{cc} =250V, IC=1A,	–	0.15	0.3	μS
Storage Time	t _{STG}	IB1=0.2A, IB2 = 0.2A, tp = 25μS	–	0.5	0.9	μS
Fall Time	t _f	Duty Cycle < 1%	–	0.2	0.4	μS

Diode

Parameter	Symbol	Test Condition	Min	Typ	Max	Unit
Fall Time	t _f	I _c =1A	–	–	800	μS
Forward Voltage Drop	V _f	I _c =1A	–	–	1.4	V

Note: Pulse Duration = 300μS, duty cycle ≤ 2%

Thermal Performance

Parameter	Symbol	Limit	Unit
Junction to Case Thermal Resistance	R _{θ JC}	6.25	°C/W
Junction to Ambient Thermal Resistance	R _{θ JA}	100	°C/W

Electrical Characteristic Curves

Static Characteristics

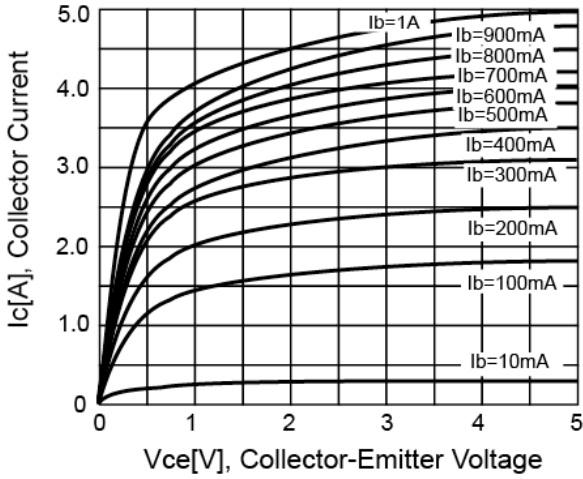

DC Current Gain

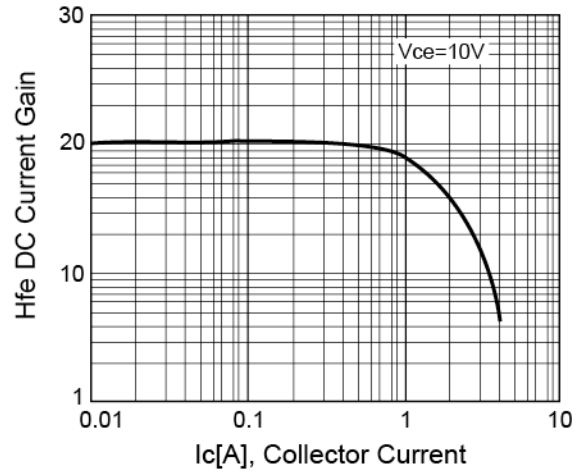

$V_{ce(sat)}$ v.s $V_{be(sat)}$

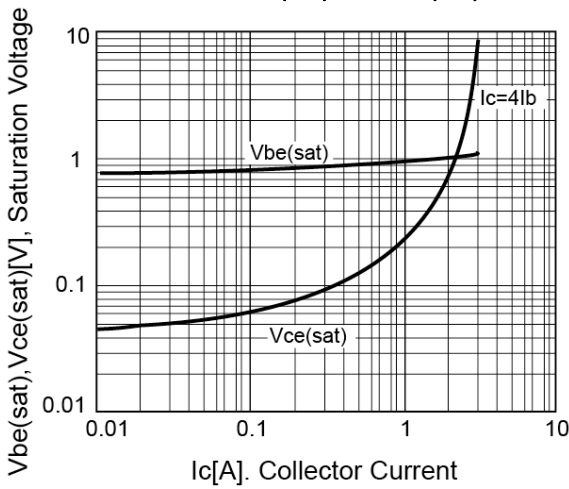

Power Derating

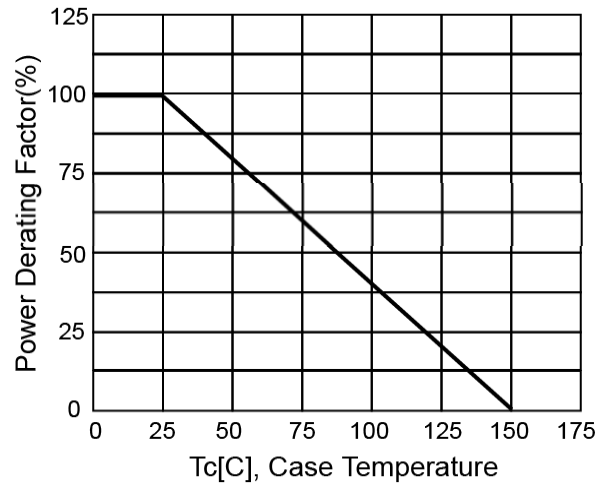

Reverse Bias SOA

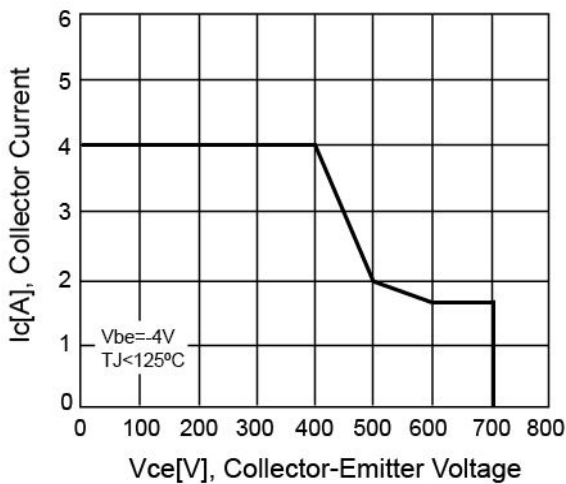

Safety Operating Area

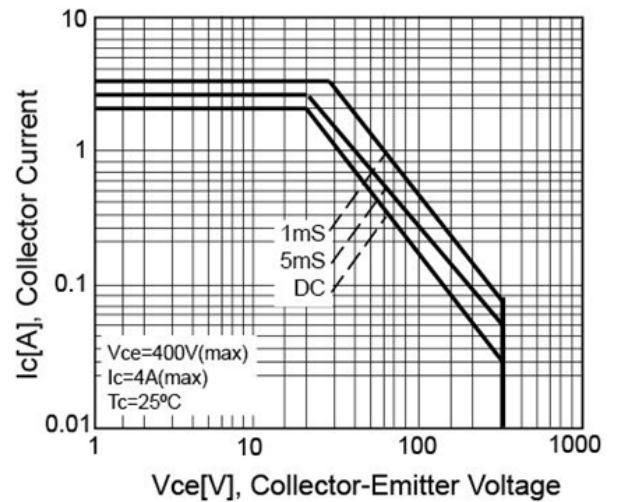

Ordering Information

Type NO	Marking	Package Code
WTBV118DI	118DI	TO-251

Marking and Pin Define

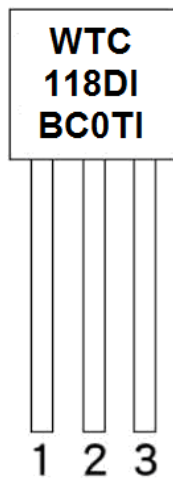

First Line	WTC	Company Name	
Second Line	118DI	Product Code	
Third Line	BC0TI	1st (Year Code)	A-2010 B-2011 C-2012 ...
		2nd (Month Code)	A-Jan, B-Feb, C-Mar, D-Apr, E-May, F-Jun, G-Jul, H-Aug, I-Sep, J-Oct, K-Nov, L-Dec
		3rd (Lot Code)	0~1, A~9
		4th (Product Code)	M-MOS, T-Transistor
		5th (Package Code)	I-T0251, D-T0252, L-T092, M-T0126
		6th (Spec Code)	(Reserve)

TO-251 Package Dimension

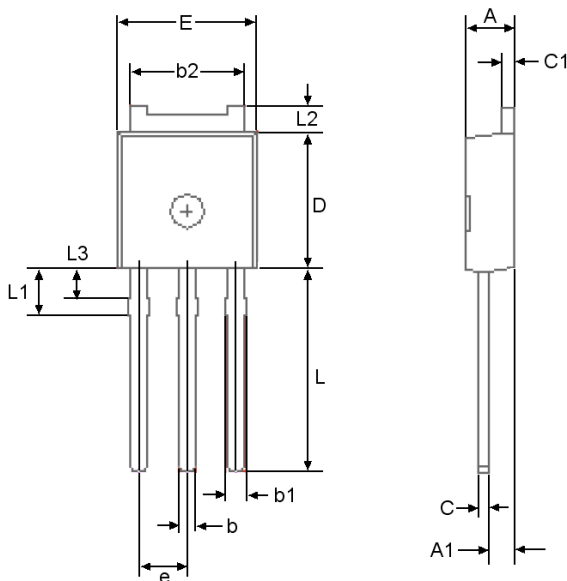

TO-251 DIMENSION				
DIM	MILLIMETERS		INCHES	
	MIN	MAX	MIN	MAX
A	2.19	2.38	0.086	0.094
A1	0.89	1.14	0.035	0.045
b	0.64	0.89	0.025	0.035
b1	0.76	1.14	0.030	0.045
b2	5.21	5.46	0.205	0.215
C	0.46	0.58	0.018	0.023
C1	0.46	0.58	0.018	0.023
D	5.97	6.10	0.235	0.240
E	6.35	6.73	0.250	0.265
e	2.28 BSC.		0.90 BSC.	
L	8.89	9.65	0.350	0.380
L1	1.91	2.28	0.075	0.090
L2	0.89	1.27	0.035	0.050
L3	1.15	1.52	0.045	0.060