

## Surface Mount Dual N-Channel Enhancement Mode MOSFET

**(Pb)** Lead(Pb)-Free

### Features:

\*Super high dense cell design for low  $R_{DS(ON)}$

$$R_{DS(ON)} < 26m\Omega @ V_{GS} = 10V$$

$$R_{DS(ON)} < 40m\Omega @ V_{GS} = 4.5V$$

\*Simple Drive Requirement

\*Dual N MOSFET Package

\*SO-8 Package

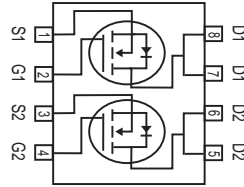

**DRAIN CURRENT**  
**6.8 AMPERES**  
**DRAIN SOURCE VOLTAGE**  
**30 VOLTAGE**

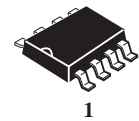

1

**SO-8**

## Maximum Ratings (TA=25°C Unless Otherwise Specified)

Rating	Symbol	Value	Unite
Drain-Source Voltage	$V_{DS}$	30	V
Gate-Source Voltage	$V_{GS}$	$\pm 20$	V
Continuous Drain Current <sup>(1)</sup> (TA=25°C) <small>www.DataSheet4U.com</small> (TA=70°C)	$I_D$	6.8	A
		5.5	A
Pulsed Drain Current <sup>(2)</sup>	$I_{DM}$	40	A
Power Dissipation <sup>(1)</sup> (TA=25°C)	$P_D$	2	W
Maximax Junction-to-Ambient <sup>(1)</sup>	$R_{\theta JA}$	62.5	°C/W
Operating Junction and Storage Temperature Range	$T_J, T_{stg}$	-55 to 150	°C

## Device Marking

WTK4228=4228SS

**WTK4228****WEITRON****Electrical Characteristics(T<sub>j</sub> = 25°C Unless otherwise specified)**

Parameter	Symbol	Min.	Typ.	Max.	Unit	Test Conditions
Drain-Source Breakdown Voltage	BV <sub>DSS</sub>	30	-	-	V	V <sub>GS</sub> =0, I <sub>D</sub> =250uA
Gate Threshold Voltage	V <sub>GS(th)</sub>	1.0	-	3.0	V	V <sub>DS</sub> =V <sub>GS</sub> , I <sub>D</sub> =250uA
Forward Transconductance	g <sub>fs</sub>	-	15	-	S	V <sub>DS</sub> =10V, I <sub>D</sub> =6A
Gate-Source Leakage Current	I <sub>GSS</sub>	-	-	±100	nA	V <sub>GS</sub> = ±20V
Drain-Source Leakage Current(T <sub>j</sub> =25°C)	I <sub>DSS</sub>	-	-	1	uA	V <sub>DS</sub> =30V, V <sub>GS</sub> =0
Drain-Source Leakage Current(T <sub>j</sub> =70°C)		-	-	25	uA	V <sub>DS</sub> =24V, V <sub>GS</sub> =0
Static Drain-Source On-Resistance <sup>2</sup>	R <sub>DS(ON)</sub>	-	-	26	mΩ	V <sub>GS</sub> =10V, I <sub>D</sub> =6A
		-	-	40		V <sub>GS</sub> =4.5V, I <sub>D</sub> =4A
Total Gate Charge <sup>2</sup>	Q <sub>g</sub>	-	9	15	nC	I <sub>D</sub> =6.8A V <sub>DS</sub> =24V V <sub>GS</sub> =4.5V
Gate-Source Charge	Q <sub>gs</sub>	-	2	-		
Gate-Drain ("Miller") Change	Q <sub>gd</sub>	-	6	-		
Turn-on Delay Time <sup>2</sup>	T <sub>d(on)</sub>	-	10	-	ns	V <sub>DS</sub> =15V I <sub>D</sub> =1A V <sub>GS</sub> =10V R <sub>G</sub> =3.3Ω R <sub>D</sub> =15Ω
Rise Time	T <sub>r</sub>	-	9	-		
Turn-off Delay Time	T <sub>d(off)</sub>	-	18	-		
Fall Time	T <sub>f</sub>	-	6	-		
Input Capacitance	C <sub>iSS</sub>	-	580	930	pF	V <sub>GS</sub> =0V V <sub>DS</sub> =25V f=1.0MHz
Output Capacitance	C <sub>oss</sub>	-	150	-		
Reverse Transfer Capacitance	C <sub>rSS</sub>	-	108	-		

**Source-Drain Diode**

Parameter	Symbol	Min.	Typ.	Max.	Unit	Test Conditions
Forward On Voltage <sup>2</sup>	V <sub>SD</sub>	-	-	1.3	V	I <sub>S</sub> =1.7A, V <sub>GS</sub> =0V, T <sub>j</sub> =25°C
Reverse Recovery Time	T <sub>rr</sub>	-	15	-	ns	I <sub>S</sub> =6.8A, V <sub>GS</sub> =0V di/dt=100A/fls
Reverse Recovery Charge	Q <sub>rr</sub>	-	9	-	nC	

Notes: 1. Pulse width limited by Max. junction temperature.

2. Pulse width ≤ 300us, duty cycle ≤ 2%.

3. Surface mounted on 1 in<sup>2</sup> copper pad of FR4 board; 135°C/W when mounted on Min. copper pad.

WTK4228



Characteristics Curve

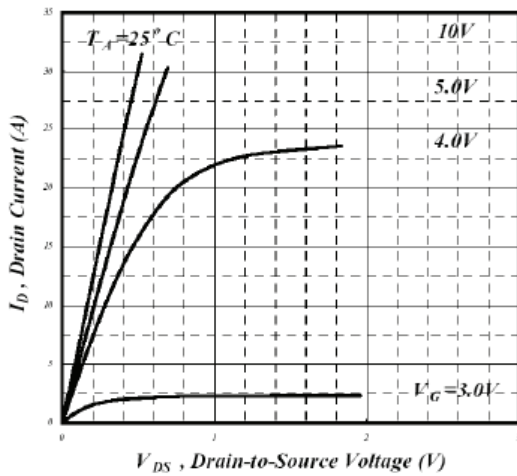

Fig 1. Typical Output Characteristics

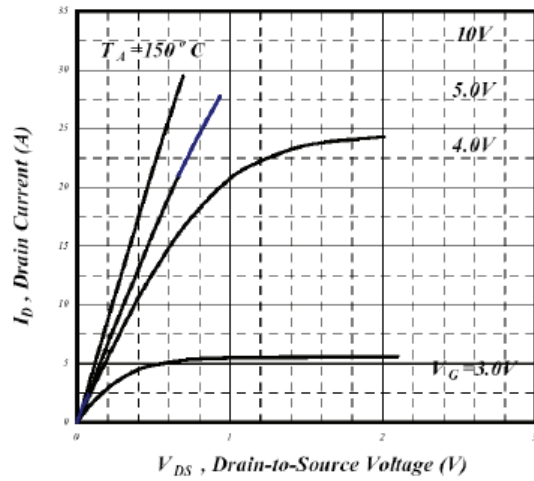

Fig 2. Typical Output Characteristics

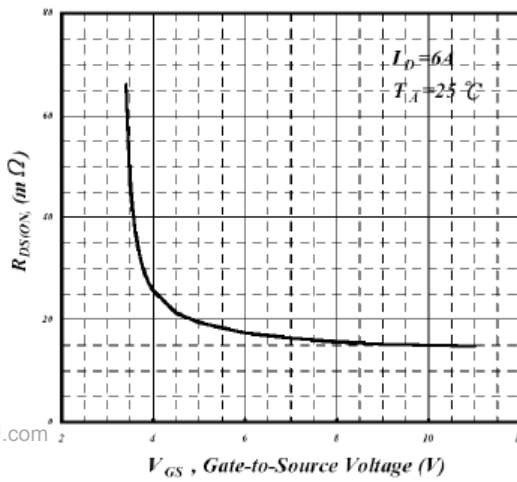

Fig 3. On-Resistance v.s. Gate Voltage

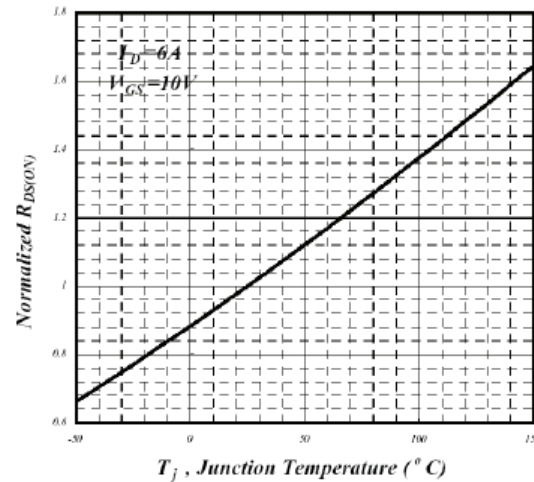

Fig 4. Normalized On-Resistance v.s. Junction Temperature

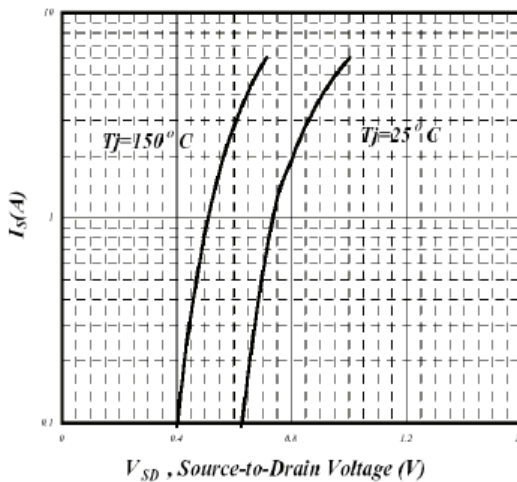

Fig 5. Forward Characteristics of Reverse Diode

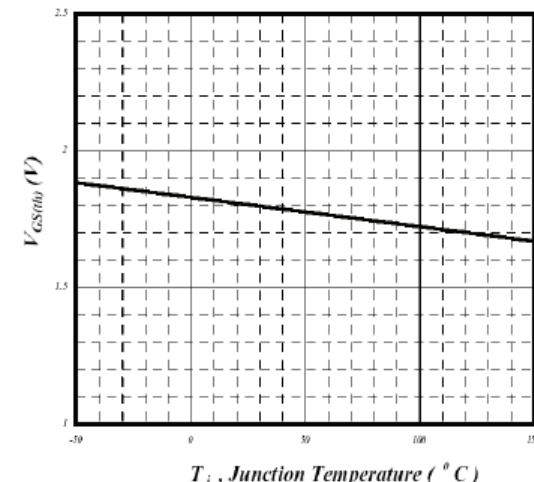

Fig 6. Gate Threshold Voltage v.s. Junction Temperature

www.DataSheet4U.com

WTK4228

WEITRON

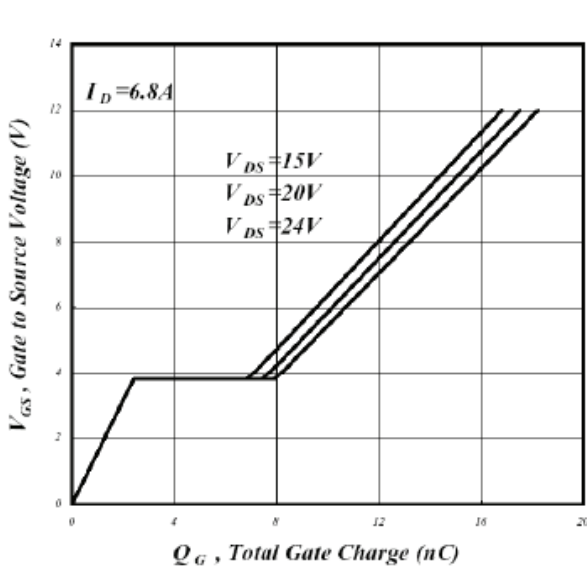

Fig 7. Gate Charge Characteristics

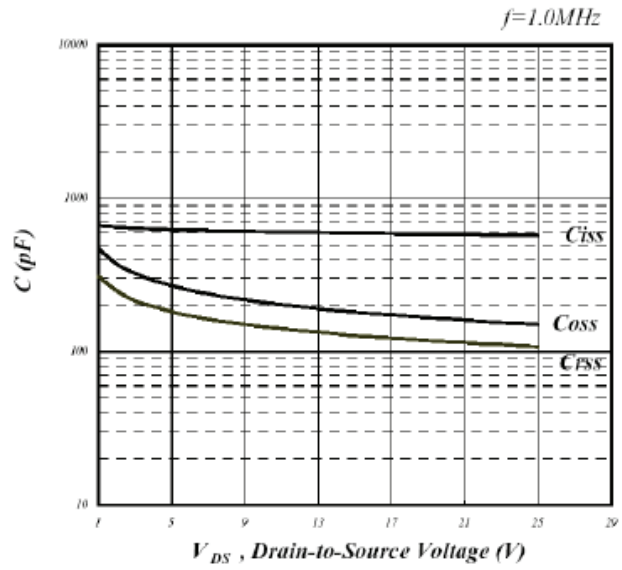

Fig 8. Typical Capacitance Characteristics

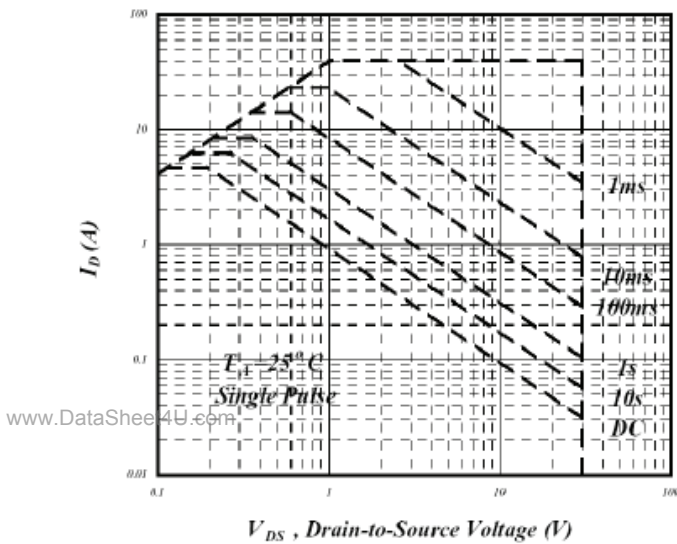

Fig 9. Maximum Safe Operating Area

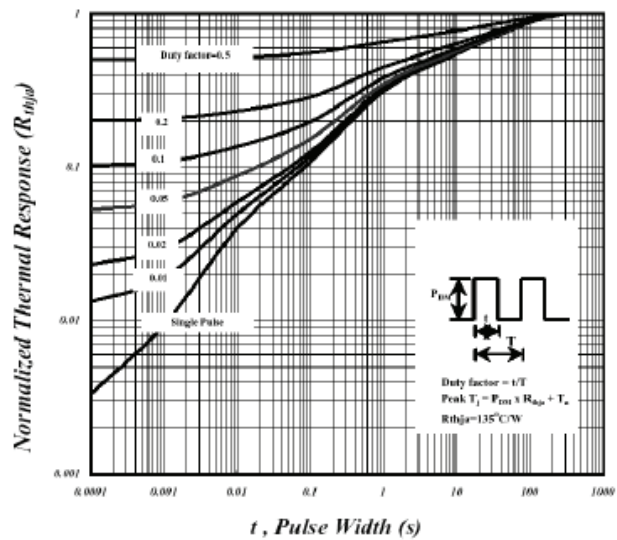

Fig 10. Effective Transient Thermal Impedance

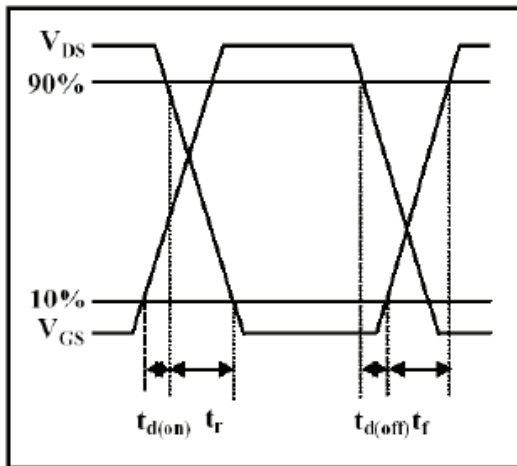

Fig 11. Switching Time Waveform

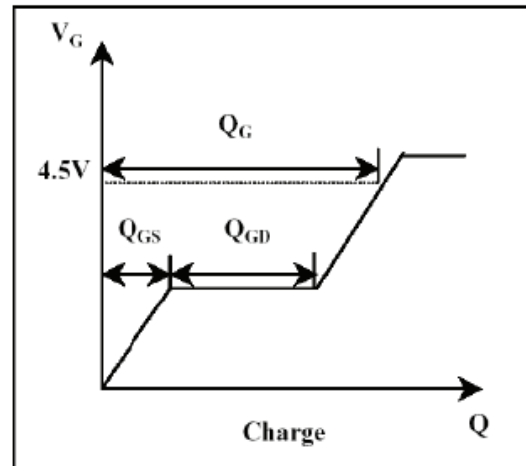
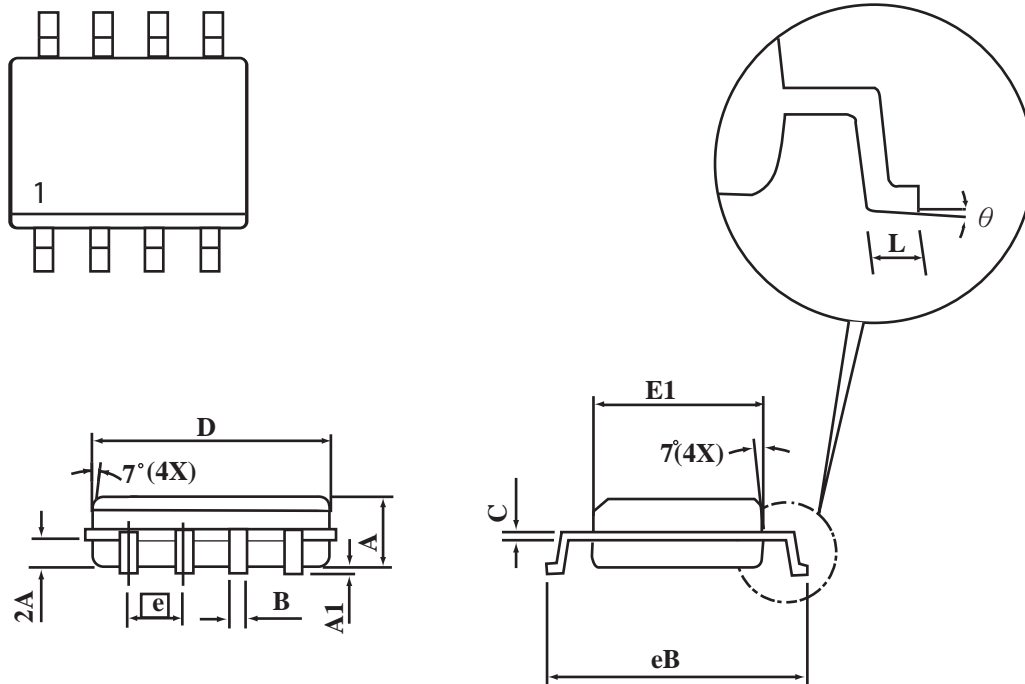

Fig 12. Gate Charge Waveform

**WTK4228****WEITRON****SO-8 Package Outline Dimensions**

Unit:mm



SYMBOLS	MILLIMETERS	
	MIN	MAX
A	1.35	1.75
A1	0.10	0.20
B	0.35	0.45
C	0.18	0.23
D	4.69	4.98
E1	3.56	4.06
eB	5.70	6.30
e	1.27 BSC	
L	0.60	0.80
$\theta$	0°	8°

www.DataSheet4U.com