

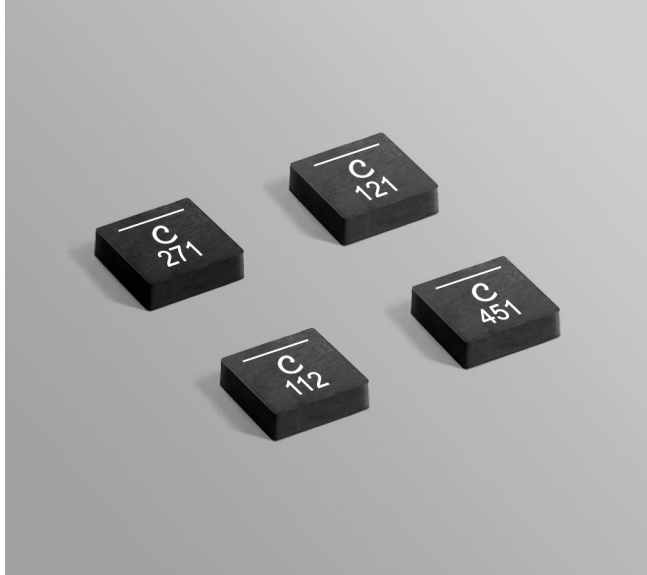

Shielded Power Inductors – XAL6020



- High current and very low DCR
- Very low profile – only 2 mm tall
- Soft saturation, perfect for VRM/VRD applications

Core material Composite

Environmental RoHS compliant, halogen free

Terminations RoHS compliant tin-silver (96.5/3.5) over copper. Other terminations available at additional cost.

Weight 0.36 – 0.49 g

Ambient temperature –40°C to +125°C with (40°C rise) Irms current.

Maximum part temperature +165°C (ambient + temp rise). **Derating.**

Storage temperature Component: –40°C to +165°C.

Tape and reel packaging: –40°C to +80°C

Resistance to soldering heat Max three 40 second reflows at +260°C, parts cooled to room temperature between cycles

Moisture Sensitivity Level (MSL) 1 (unlimited floor life at <30°C / 85% relative humidity)

Failures in Time (FIT) / Mean Time Between Failures (MTBF)

38 per billion hours / 26,315,789 hours, calculated per Telcordia SR-332

Packaging 500/7" reel; 1500/13" reel Plastic tape: 16 mm wide, 0.3 mm thick, 12 mm pocket spacing, 2.16 mm pocket depth

PCB washing Tested to MIL-STD-202 Method 215 plus an additional aqueous wash. See [Doc787_PCB_Washing.pdf](#).

Part number ¹	Inductance ² ±20% (µH)	DCR (mOhms) ³		SRF typ ⁴ (MHz)	Isat ⁵ (A)	Irms (A) ⁶	
		typ	max			20°C rise	40°C rise
XAL6020-121ME_	0.12	1.60	1.85	165	45	21.0	27.0
XAL6020-141ME_	has been changed to XAL6020-121ME_. The XAL6020-141 is not available.						
XAL6020-161ME_	0.16	2.35	2.70	152	41	20.0	26.0
XAL6020-271ME_	0.27	3.45	3.85	97	29.5	19.0	25.0
XAL6020-321ME_	has been changed to XAL6020-271ME_. The XAL6020-321 is not available.						
XAL6020-451ME_	0.45	4.60	5.05	73	24.5	17.0	22.0
XAL6020-601ME_	0.60	6.45	7.10	66	20.5	15.0	18.5
XAL6020-901ME_	0.90	10.63	11.10	56	19.1	11.5	15.2
XAL6020-112ME_	1.1	12.60	13.10	50	17.1	10.0	12.0

1. When ordering, please specify **packaging** code:

XAL6020-112MEC

Packaging: C = 7" machine-ready reel. EIA-481 embossed plastic tape (500 parts per full reel).

B = Less than full reel. In tape, but not machine ready. To have a leader and trailer added (\$25 charge), use code letter C instead.

D = 13" machine-ready reel. EIA-481 embossed plastic tape. Factory order only, not stocked (2000 parts per full reel).

2. Inductance tested at 1 MHz, 0.1 Vrms, 0 Adc.

3. DCR measured on a micro-ohmmeter.

4. SRF measured using Agilent/HP 4395A or equivalent.

5. DC current at 25°C that causes an inductance drop of 30% (typ) from its value without current.

[Click for temperature derating information.](#)

6. Current that causes the specified temperature rise from 25°C ambient. This information is for reference only and does not represent absolute maximum ratings. [Click for temperature derating information.](#)

7. Electrical specifications at 25°C.

Refer to Doc 362 "Soldering Surface Mount Components" before soldering.

Irms Testing

Irms testing was performed on 0.75 inch wide × 0.25 inch thick copper traces in still air.

Temperature rise is highly dependent on many factors including pcb land pattern, trace size, and proximity to other components. Therefore temperature rise should be verified in application conditions.



Shielded Power Inductors – XAL6020

L vs Current

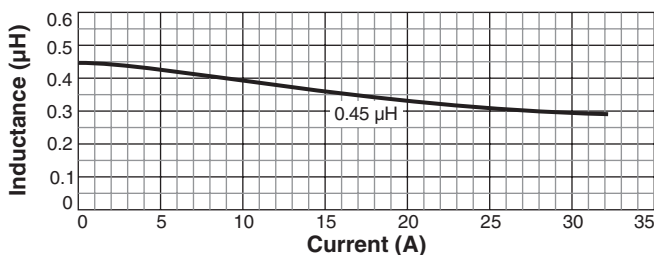
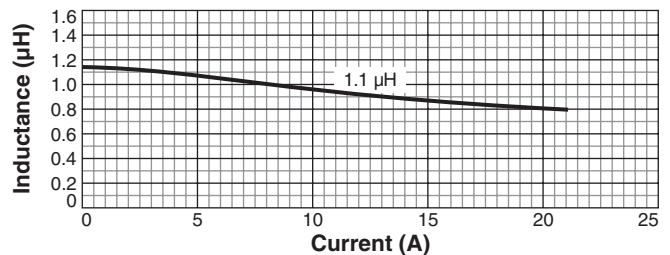
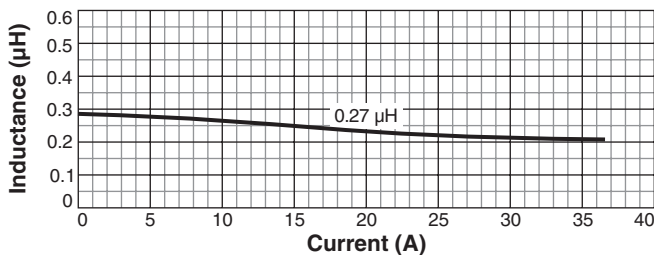
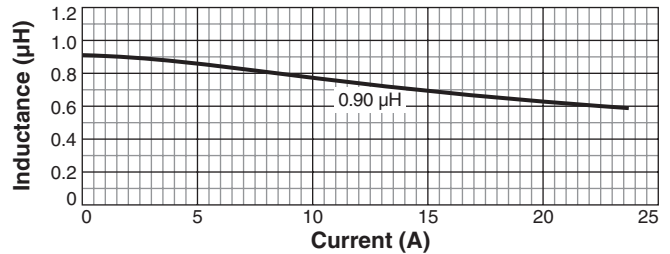
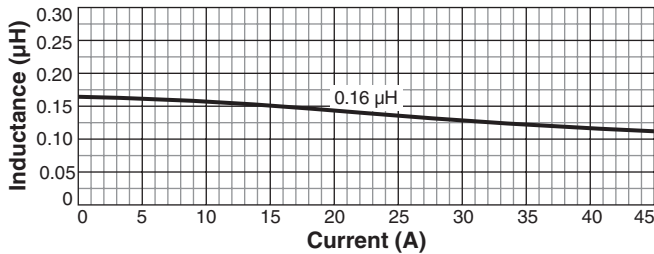
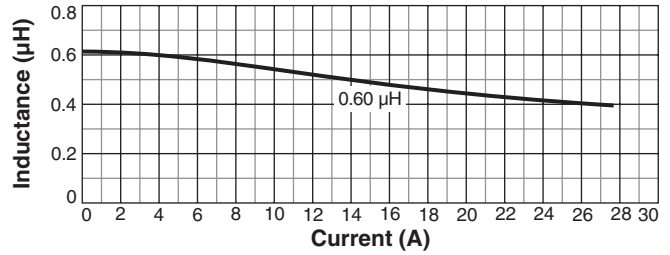
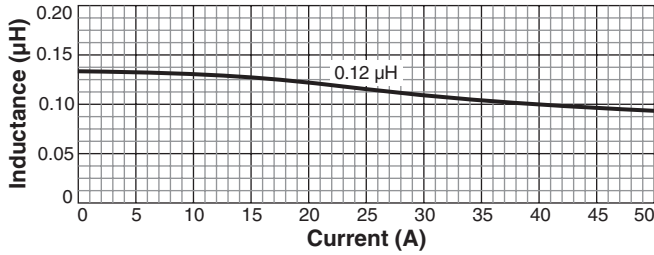

US +1-847-639-6400 sales@coilcraft.com
UK +44-1236-730595 sales@coilcraft-europe.com
Taiwan +886-2-2264 3646 sales@coilcraft.com.tw
China +86-21-6218 8074 sales@coilcraft.com.cn
Singapore + 65-6484 8412 sales@coilcraft.com.sg

Document 801-2 Revised 01/14/18
 © Coilcraft Inc. 2018
 This product may not be used in medical or high risk applications without prior Coilcraft approval. Specification subject to change without notice. Please check web site for latest information.



Shielded Power Inductors – XAL6020

L vs Frequency

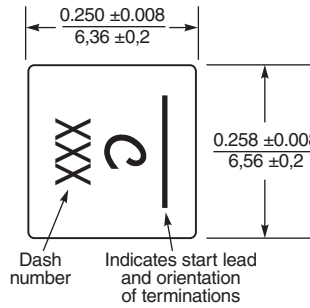
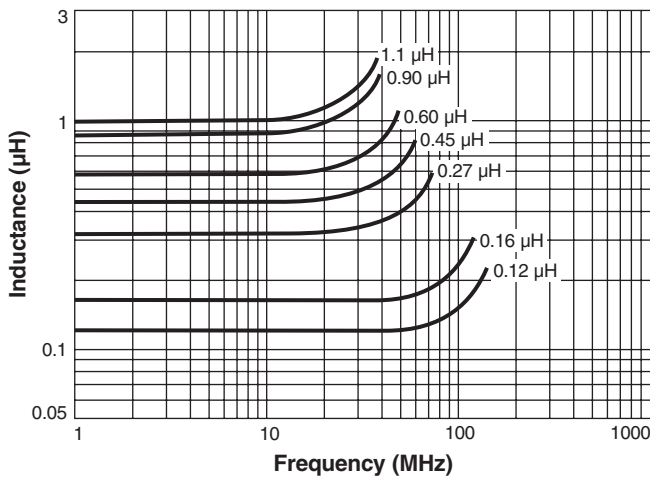

Dash number	Terminal thickness (typ) (in / mm)
-121	0.0106 / 0.27
-161	0.0071 / 0.18
-271	0.0071 / 0.18
-451	0.0071 / 0.18
-601	0.0047 / 0.12
-901	0.0039 / 0.10
-112	0.0039 / 0.10

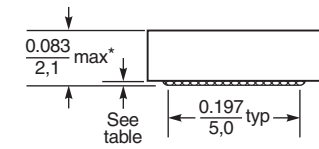
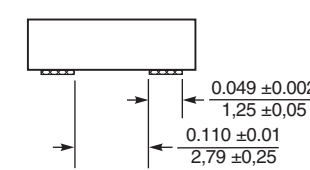

* For optional tin-lead and tin-silver-copper terminations, dimensions are for the mounted part. Dimensions before mounting can be an additional 0.005 inch / 0.13 mm.

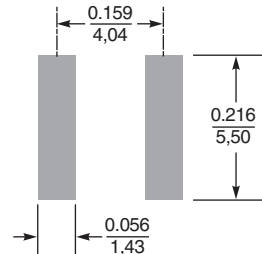

Recommended Land Pattern

Dimensions are in $\frac{\text{inches}}{\text{mm}}$



US +1-847-639-6400 sales@coilcraft.com
UK +44-1236-730595 sales@coilcraft-europe.com
Taiwan +886-2-2264 3646 sales@coilcraft.com.tw
China +86-21-6218 8074 sales@coilcraft.com.cn
Singapore + 65-6484 8412 sales@coilcraft.com.sg

Document 801-3 Revised 01/14/18
 © Coilcraft Inc. 2018
 This product may not be used in medical or high risk applications without prior Coilcraft approval. Specification subject to change without notice. Please check web site for latest information.