

## UHF Band Low Noise Amplifier

## ■ GENERAL DESCRIPTION

The XC2402KT69UR-G is an ultra-low-noise amplifier (LNA) with low operating voltage, low noise figure (NF), low power consumption using CMOS process. The XC2402 is designed for 470MHz~880MHz bandwidths of terrestrial digital TV.

The device offers easy output matching to 50Ω for input and output with less external components.

With external control mode, High Gain mode can be selected by passing through the amplifier circuit and Low Gain mode can be selected by bypassing the amplifier circuit. Low Gain mode in environments with good radio wave conditions to help save system energy.

## ■ APPLICATION

- Digital terrestrial television RF module

## ■ FEATURES

Operation Voltage Range	: 1.14V~1.26V
Output	: CMOS Output, 50Ω driver built-in
● High Gain Mode	
Noise Figure	: NF=1.4dB(TYP.) (@620MHz)
Low Power Consumption	: 9.4mW (TYP.) ( $V_{DD}=1.2V$ )
Gain	: S21 =15dB(TYP.) (@ 620MHz)
● Low Gain Mode	
Noise Figure	: NF=1.4dB(TYP.) (@620MHz)
Low Power Consumption	: 3.5 μW (TYP.) ( $V_{DD}=1.2V$ )
Gain	: S21 =-1.4dB(TYP.) (@ 620MHz)
Operating Ambient Temperature	: -40°C~+85°C
Ultra Small Package	: USP-8A01
Environmentally Friendly	: EU RoHS Compliant, Pb Free

## ■ TYPICAL APPLICATION CIRCUIT ■ TYPICAL PERFORMANCE CHARACTERISTICS

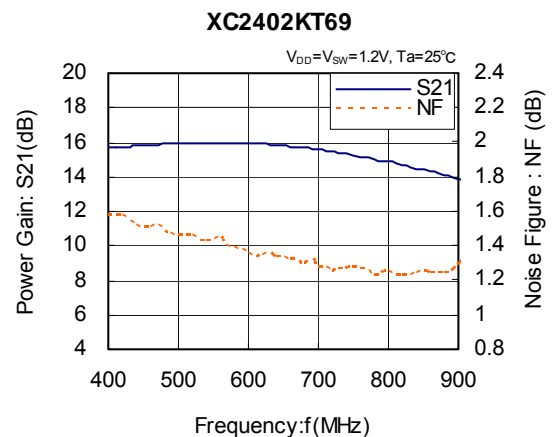
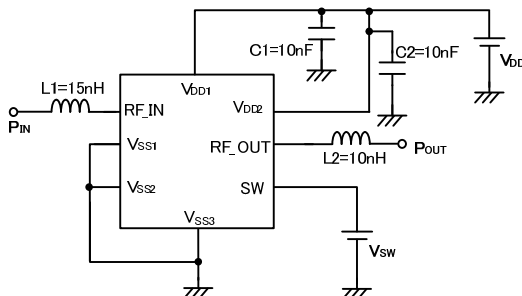

## ■ BLOCK DIAGRAM

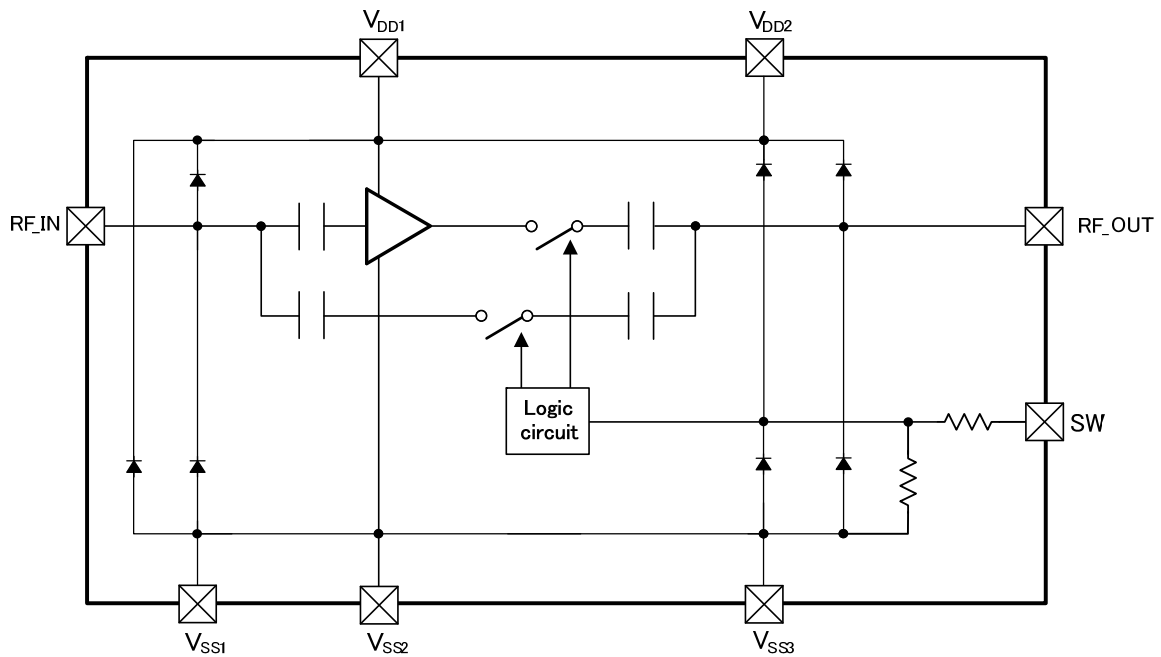

\* Diodes inside the circuit are an ESD protection diode.

## ■ PRODUCT CLASSIFICATION

### ● Ordering Information

PRODUCT NAME	PACKAGE	ORDER UNIT
XC2402KT69UR-G <sup>(*)</sup>	USP-8A01	3,000/Reel

<sup>(\*)</sup> The "-G" suffix denotes Halogen and Antimony free as well as being fully RoHS compliant.

## ■ PIN CONFIGURATION

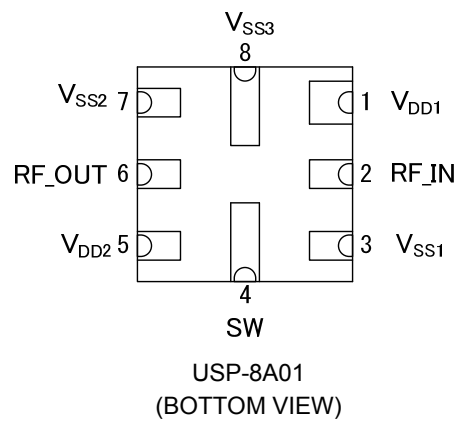

## ■ PIN ASSIGNMENT

PIN NUMBER	PIN NAME	FUNCTIONS
USP-8A01		
1	V <sub>DD1</sub>	Power Supply
2	RF_IN	RF Signal Input
3	V <sub>SS1</sub>	Ground
4	SW	Gain Switching
5	V <sub>DD2</sub>	Power Supply
6	RF_OUT	RF Signal Output
7	V <sub>SS2</sub>	Ground
8	V <sub>SS3</sub>	Ground

## ■ FUNCTION CHART

PIN NAME	SIGNAL	STATUS
SW	L	Low Gain Mode
	H	High Gain Mode
	OPEN	Low Gain Mode

## ■ ABSOLUTE MAXIMUM RATINGS

Ta=25°C

PARAMETER	SYMBOL	RATINGS	UNITS
Power Supply Voltage	V <sub>DD</sub>	-0.3~+1.6	V
Current Circuit	I <sub>DD</sub>	42	mA
RF Input Power	P <sub>IN</sub>	10	dBm
RF_IN Input Voltage	V <sub>RF_IN</sub>	-0.3~V <sub>DD</sub> +0.3 or +1.6 <sup>(*)1</sup>	V
RF_OUT Input Voltage	V <sub>RF_OUT</sub>	-0.3~V <sub>DD</sub> +0.3 or +1.6 <sup>(*)1</sup>	V
SW Voltage	V <sub>SW</sub>	-0.45~(V <sub>DD</sub> +0.3)×1.5V or +2.4V <sup>(*)2</sup>	V
Power Dissipation	P <sub>d</sub>	120	mW
Operating Ambient Temperature	Topr	-40~+85	°C
Storage Temperature	Tstg	-55~+125	°C

\* All voltages are described based on the V<sub>SS1</sub>, V<sub>SS2</sub> and V<sub>SS3</sub>.

V<sub>DD</sub> pin (V<sub>DD1</sub> and V<sub>DD2</sub>) should be connected each other outside.

V<sub>SS</sub> pin (V<sub>SS1</sub>, V<sub>SS2</sub> and V<sub>SS3</sub>) should be connected each other outside.

<sup>(\*)1</sup> The maximum value should be either V<sub>DD</sub>+0.3V or +1.6V in the lowest.

<sup>(\*)2</sup> The maximum value should be either (V<sub>DD</sub>+0.3V)×1.5V or +2.4V in the lowest.

## ■ ELECTRICAL CHARACTERISTICS

### ● DC Characteristics

Ta=25°C

PARAMETER	SYMBOL	CONDITIONS	MIN.	TYP.	MAX.	UNITS	CIRCUIT
Power Supply Pin Voltage	V <sub>DD</sub>	V <sub>DD</sub> =V <sub>DD1</sub> , V <sub>DD2</sub>	1.14	1.2	1.26	V	①
Current Circuit 1 (High Gain Mode)	I <sub>DD1</sub>	V <sub>DD</sub> =V <sub>SW</sub> =1.2V	-	7.8	17.5	mA	①
Current Circuit 2 (Low Gain Mode)	I <sub>DD2</sub>	V <sub>DD</sub> =1.2V, V <sub>SW</sub> =0V	-	2.9	14.3	μA	①
SW "H" Level Voltage	V <sub>SWH</sub>	-	0.9	1.2	1.9	V	①
SW "L" Level Voltage	V <sub>SWL</sub>	-	0	-	0.3	V	①

### ● AC Characteristics 1 (High Gain Mode)

V<sub>DD</sub>=V<sub>SW</sub>=1.2V, Ta=25°C

PARAMETER	SYMBOL	CONDITIONS	MIN.	TYP.	MAX.	UNITS	CIRCUIT
Frequency	f	-	470	-	880	MHz	-
Power Gain	S21	f=620MHz	13	15	-	dB	②
Input Return Loss	S11	f=620MHz	-	10	-	dB	②
Output Return Loss	S22	f=620MHz	-	15	-	dB	②
Isolation	S12	f=620MHz	-	-26	-	dB	②
Noise Figure <sup>(*)</sup>	NF	f=620MHz	-	1.4	-	dB	③
Input Power IP3	I <sub>IP3</sub>	f=620MHz, 621MHz P <sub>IN</sub> =-30dBm	-	-8.0	-	dBm	④
Input Power @1dB Gain Compression	P1dB	f=620MHz	-	-18	-	dBm	②

(\*) NF is the value excluding the PCB loss.

## ELECTRICAL CHARACTERISTICS (Continued)

### ● AC Characteristics 2 (Low Gain Mode)

$V_{DD}=1.2V$ ,  $V_{SW}=0V$ ,  $T_a=25^{\circ}C$

PARAMETER	SYMBOL	CONDITIONS	MIN.	TYP.	MAX.	UNITS	CIRCUIT
Frequency	f	-	470		880	MHz	
Power Gain	S21	f=620MHz	-2.7	-1.4	-	dB	②
Input Return Loss	S11	f=620MHz	-	15		dB	②
Output Return Loss	S22	f=620MHz	-	10		dB	②
Isolation	S12	f=620MHz	-	-1.4	-	dB	②
Noise Figure <sup>(*)</sup>	NF	f=620MHz	-	1.4	-	dB	③
Input Power IP3	I <sub>IP3</sub>	f=620MHz, 621MHz P <sub>IN</sub> =-5dBm	-	+22	-	dBm	④
Input Power @ 1dB Gain Compression	P1dB	f=620MHz	-	+8.0	-	dBm	②

<sup>(\*)</sup> NF is the value excluding the PCB loss.

## ■ NOTE ON USE

1. For temporary, transitional voltage drop or voltage rising phenomenon, the IC is liable to malfunction should the ratings be exceeded.
2. Please eliminate static electricity from the operational table, people, and soldering iron.
3. Please use noiseless power supply for stable operation.
4. Please connect C1 and C2 to  $V_{DD}$  pin as close as possible.
5.  $V_{DD}$  pin ( $V_{DD1}$  and  $V_{DD2}$ ) should be connected each other outside.
6.  $V_{SS}$  pin ( $V_{SS1}$ ,  $V_{SS2}$ , and  $V_{SS3}$ ) should be connected each other outside.
7. Please ensure to use an external component which does not depend on bias or temperature too much.
8. Torex places an importance on improving our products and their reliability.  
We request that users incorporate fail-safe designs and post-aging protection treatment when using Torex products in their systems.

## TEST CIRCUITS

● Circuit ① (DC Characteristics: Power Supply Pin Voltage, Circuit Current)

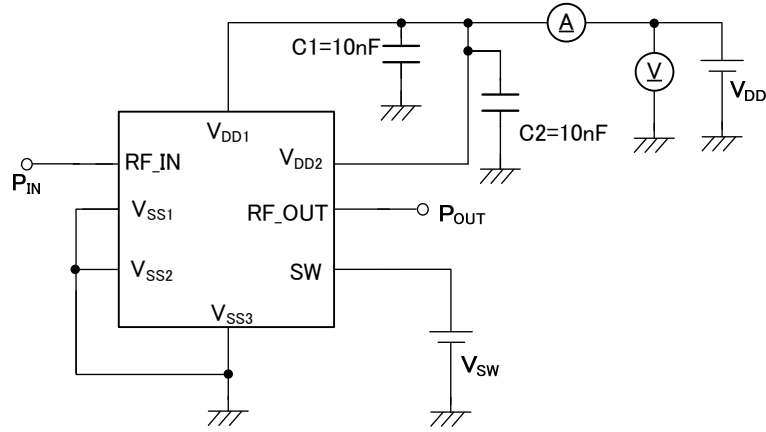

\*  $P_{IN} / P_{OUT}$  is  $50\Omega$

● Circuit ② (Power Gain, Input Return Loss, Output Return Loss, Isolation, Input Power @ 1dB Gain Compression)

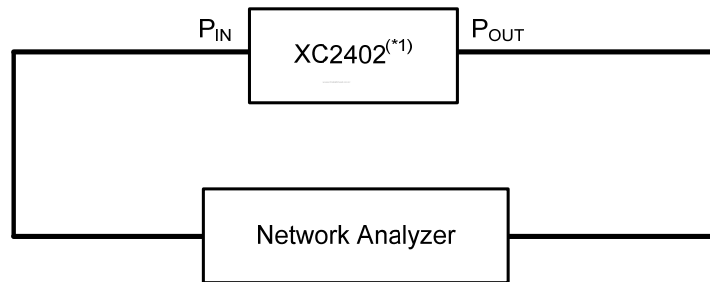

<sup>(\*)</sup> Refer to the circuit ⑤ for the block detail.

● Circuit ③ (Noise Figure)

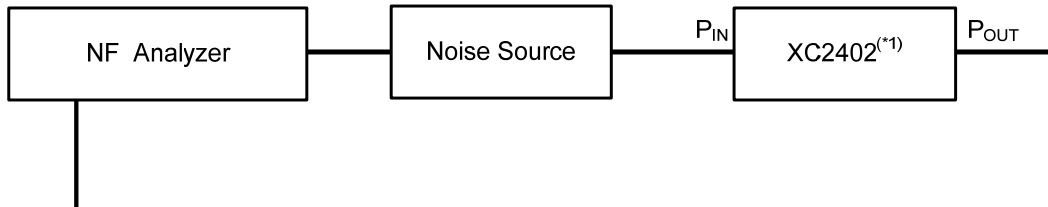

<sup>(\*)</sup> Refer to the circuit ⑤ for the block detail.



## ■ TEST CIRCUITS (Continued)

### ● Circuit ④ (Input Power IP3)

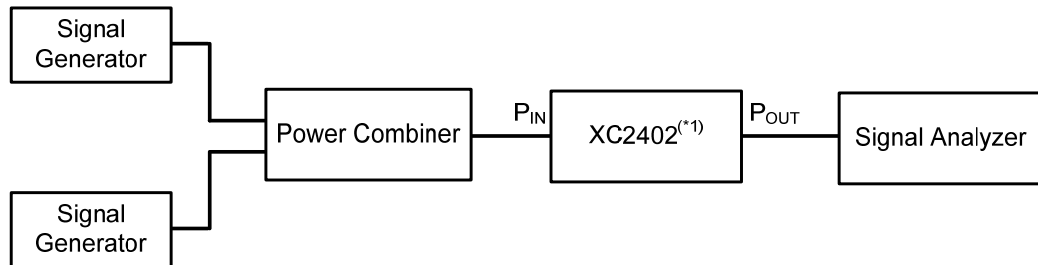

(\*1) Refer to the circuit ⑤ for the block detail.

### ● Circuit ⑤ (XC2402 series, the circuit of the block)

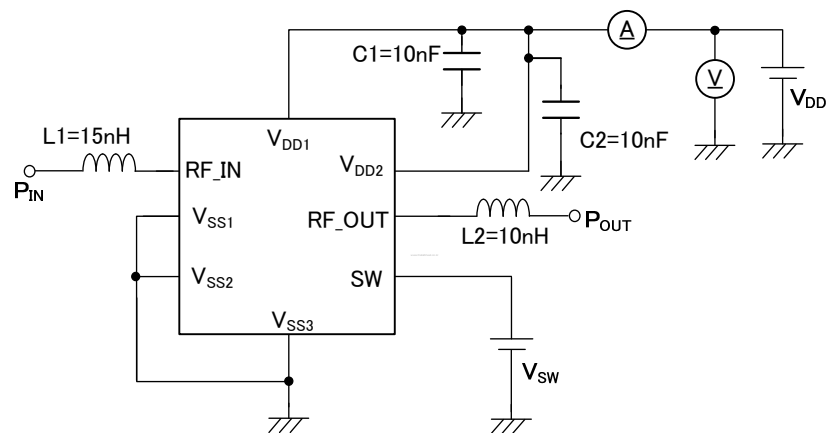

# XC2402KT69UR-G

## TEST CIRCUITS (Continued)

Evaluation Board

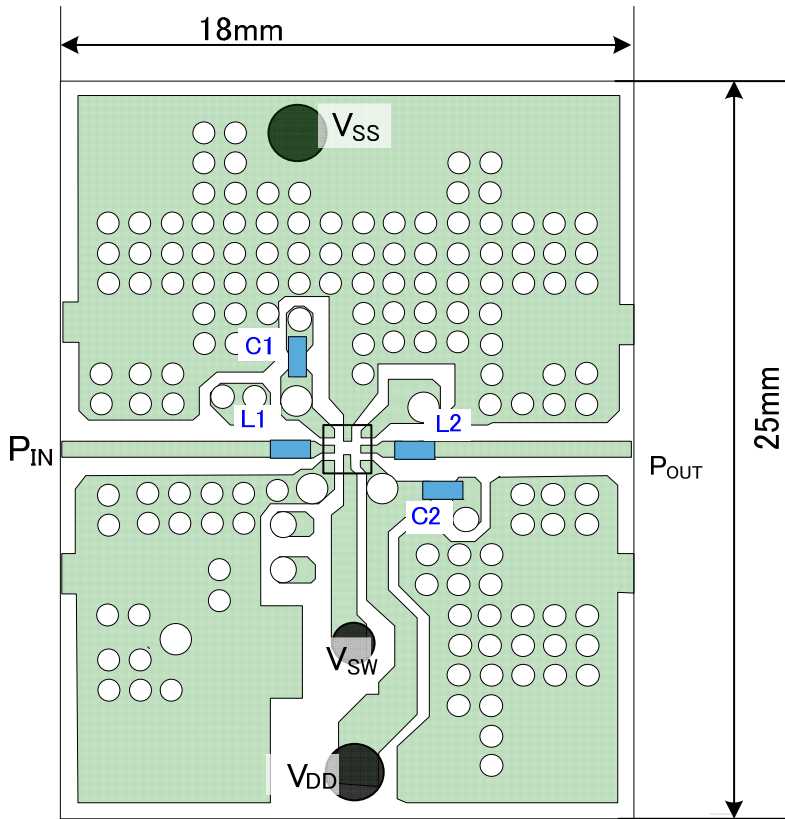

PCB (FR-4)  
MICROSTRIPLINE WIDTH=0.6mm  
t=0.018mm  
PCB size=18mm × 25mm

\* Please use an external component which does not depend on bias or temperature too much.

### External Components

SYMBOL	SPEC	COMMENT
C1, 2	10nF	-
L1	15nH	MURATA (LQW15AN15NG00)
L2	10nH	MURATA (LQG15HS10NJ02)

## TYPICAL PERFORMANCE CHARACTERISTICS

### OH High Gain Mode

(1) Current Circuit 1 vs. Supply Voltage

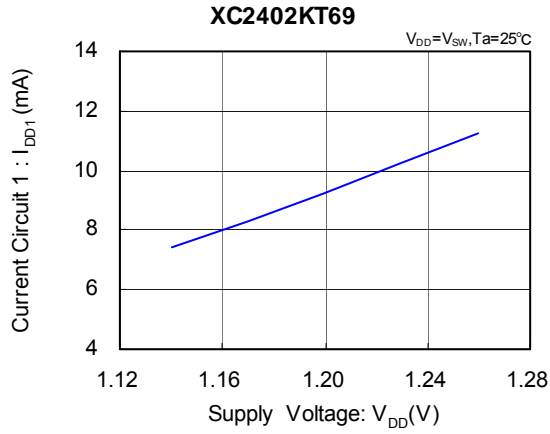

(2) SW "H" Level Voltage vs. Supply Voltage

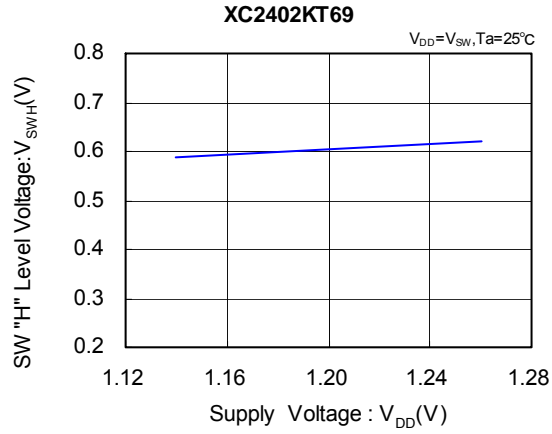

(3) SW "L" Level Voltage vs. Supply Voltage

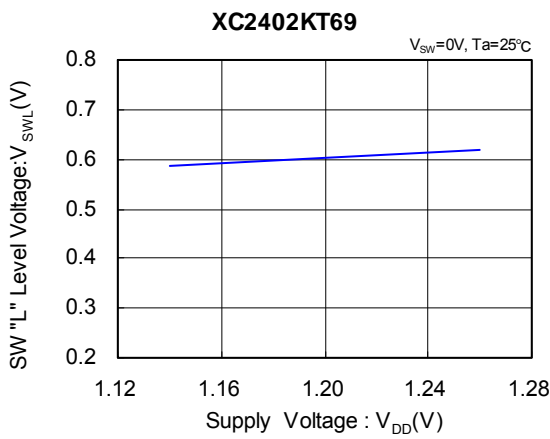

(4) Power Gain vs. Supply Voltage

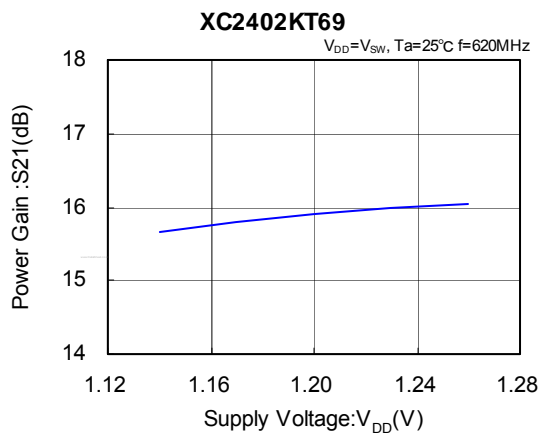

(5) Input Return Loss vs. Supply Voltage

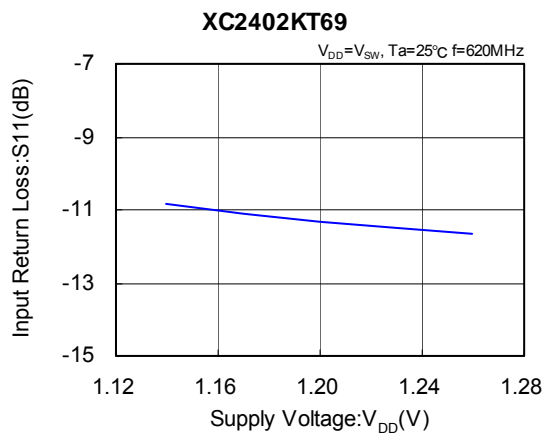

(6) Output Return Loss vs. Supply Voltage

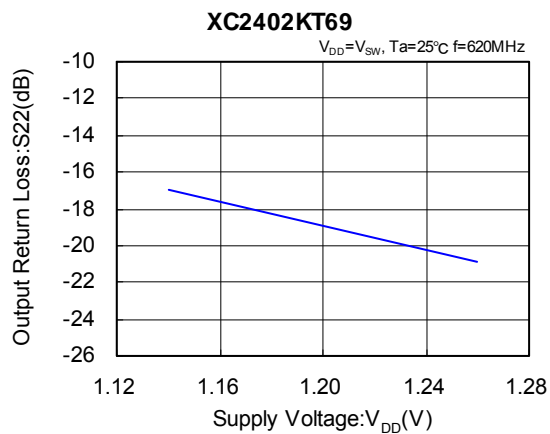

## TYPICAL PERFORMANCE CHARACTERISTICS (Continued)

OH High Gain Mode

(7) Isolation vs. Supply Voltage

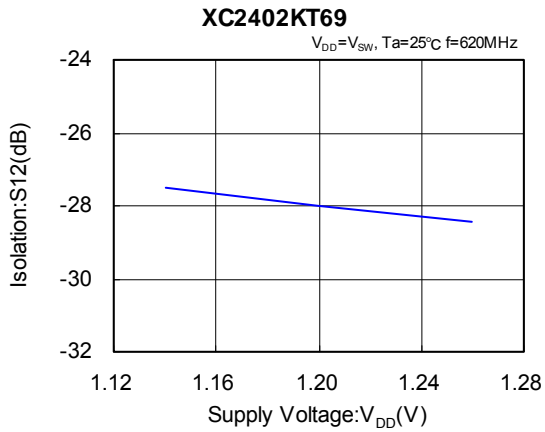

(8) Noise Figure vs. Supply Voltage

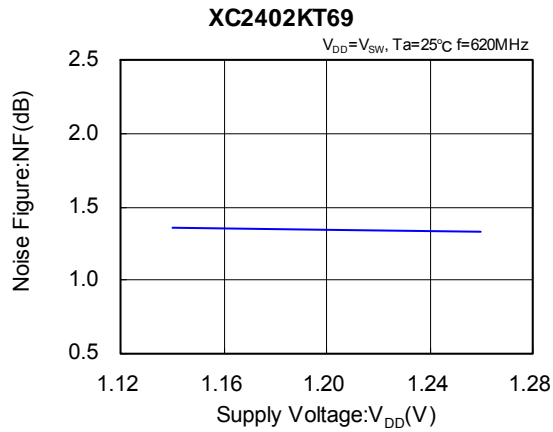

(9) Input Power IP3 vs. Supply Voltage

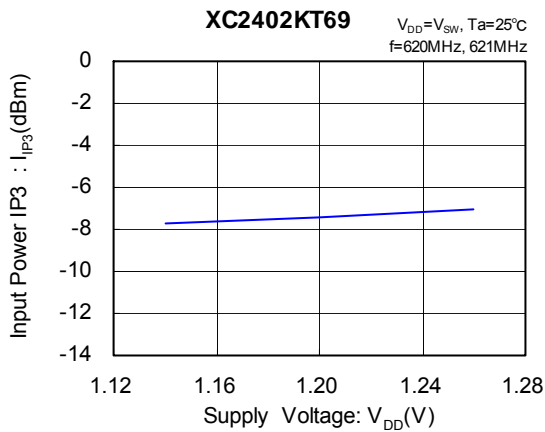

(10) Input Power @ 1dB Gain Compression vs. Supply Voltage

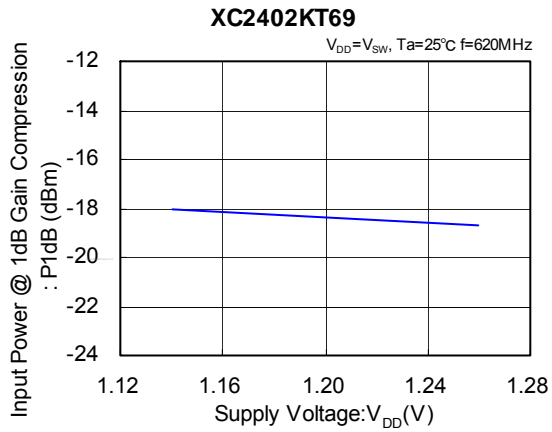

(11) Current Circuit 1 vs. Ambient Temperature

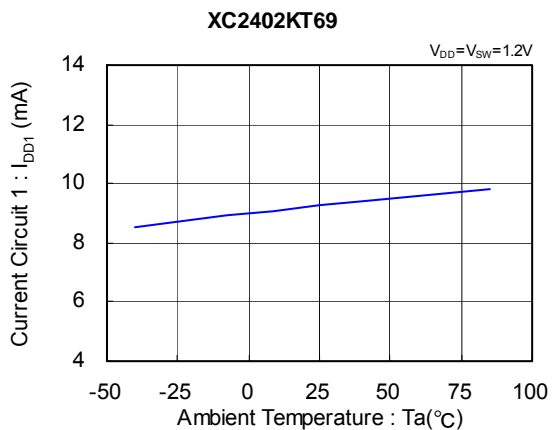

(12) SW "H" Level Voltage vs. Ambient Temperature

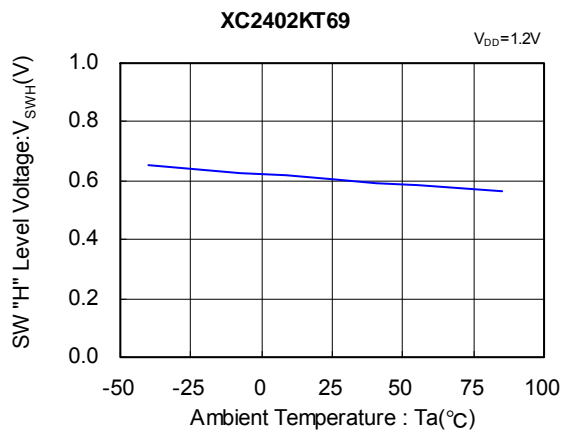

■ TYPICAL PERFORMANCE CHARACTERISTICS (Continued)

OH High Gain Mode

(13) SW "L" Level Voltage vs. Ambient Temperature

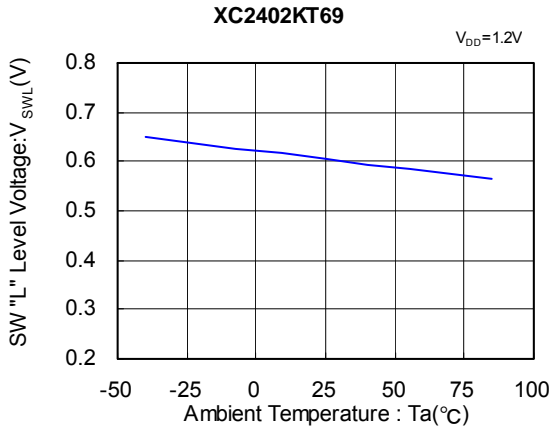

(14) Power Gain vs. Ambient Temperature

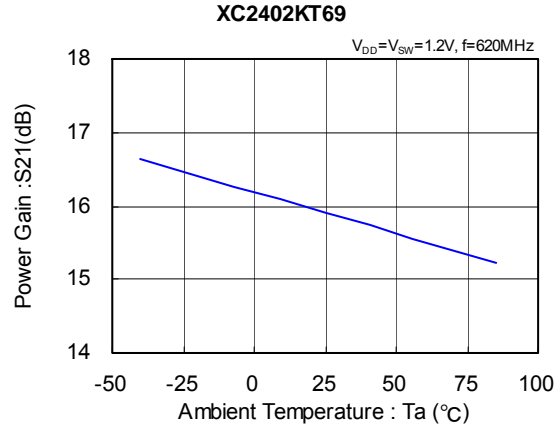

(15) Input Return Loss vs. Ambient Temperature

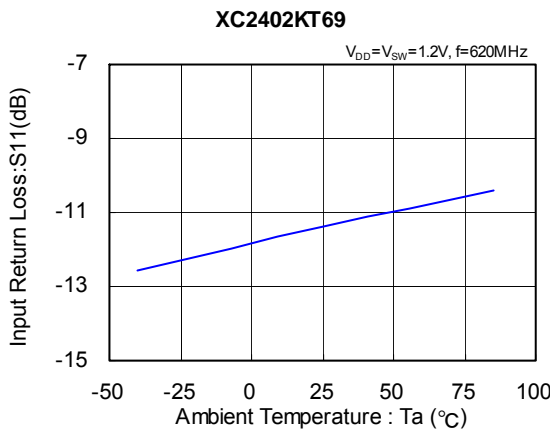

(16) Output Return Loss vs. Ambient Temperature

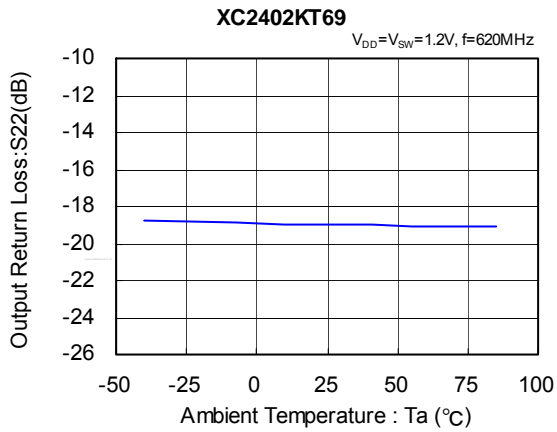

(17) Isolation vs. Ambient Temperature

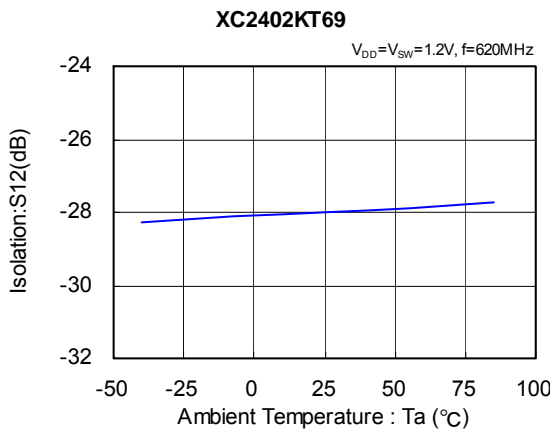

(18) Noise Figure vs. Ambient Temperature

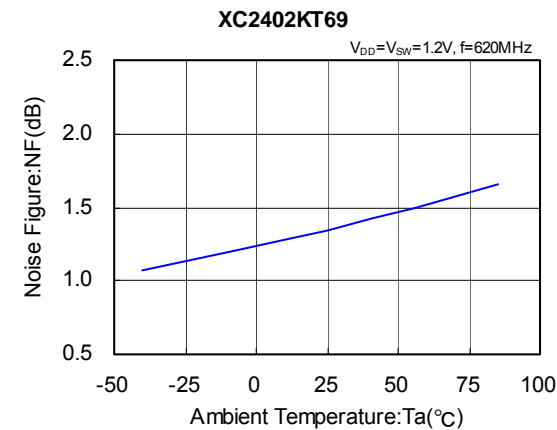

## TYPICAL PERFORMANCE CHARACTERISTICS (Continued)

OH High Gain Mode

(19) Input Power IP3 vs. Ambient Temperature

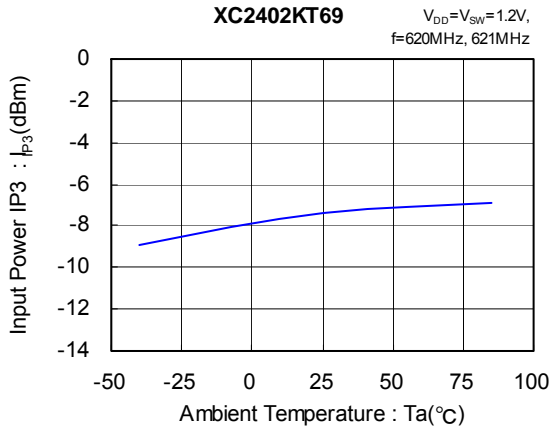

(20) Input Power @ 1dB Gain Compression vs. Ambient Temperature

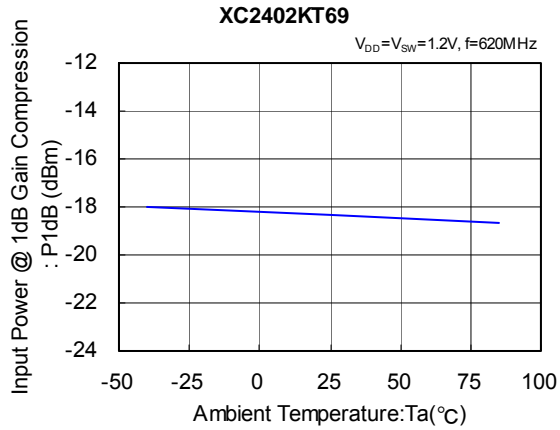

(21) Power Gain vs. Frequency

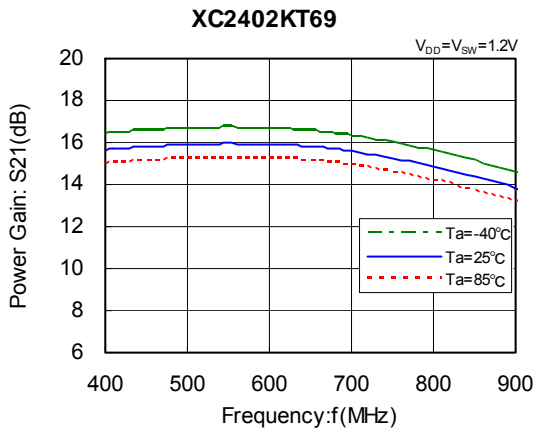

(22) Input Return Loss vs. Frequency

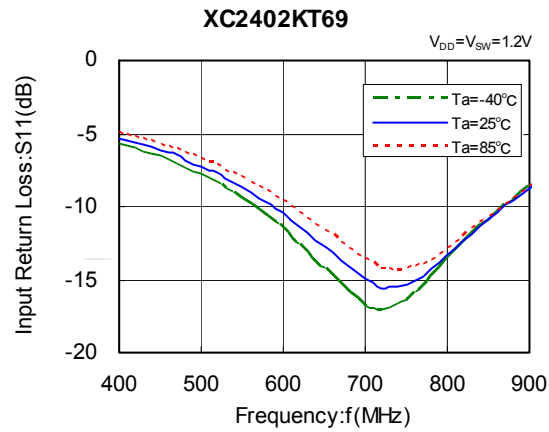

(23) Output Return Loss vs. Frequency

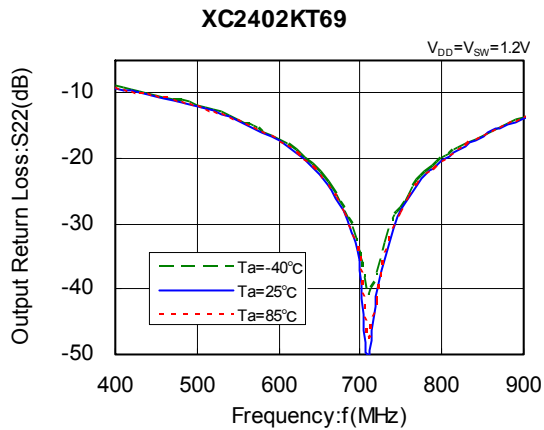

(24) Isolation vs. Frequency

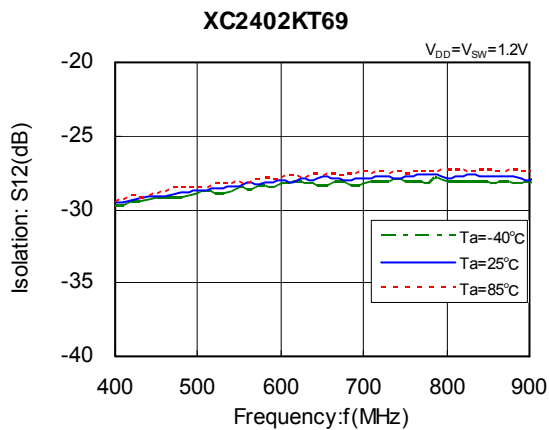

■ TYPICAL PERFORMANCE CHARACTERISTICS (Continued)

OH High Gain Mode

(25) Noise Figure vs. Frequency

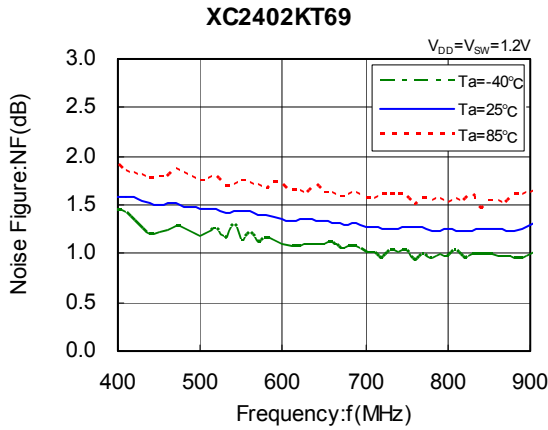

(26) Power Gain vs. Input Power

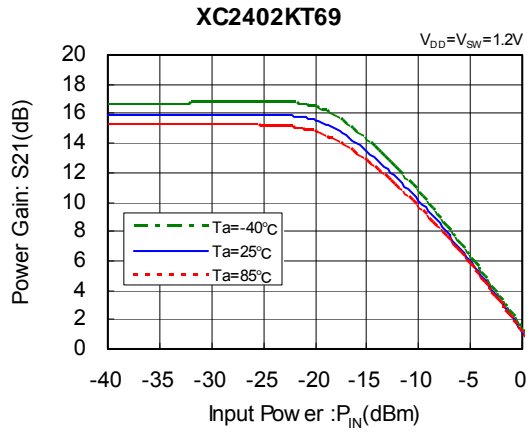

(27) Output Power / IM3 vs. Input Power

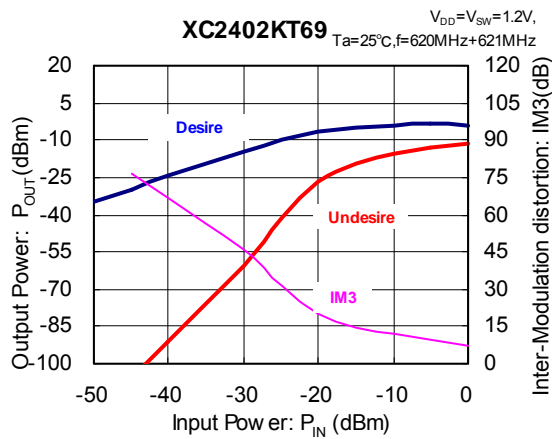

(28) Input Return Loss vs. Frequency (Smith Chart)

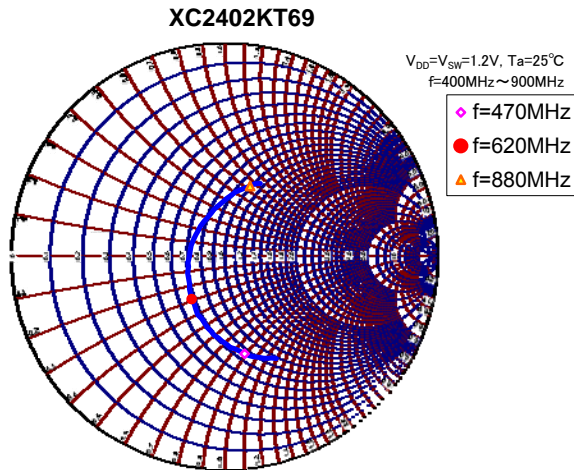

(29) Output Return Loss vs. Frequency (Smith Chart)

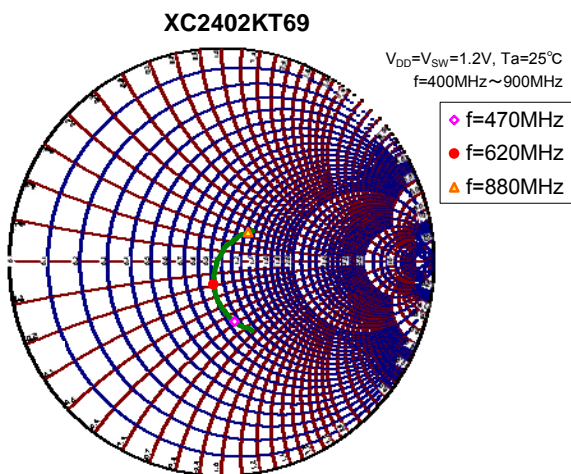

## TYPICAL PERFORMANCE CHARACTERISTICS (Continued)

### Low Gain Mode

(30) Current Circuit 2 vs. Supply Voltage

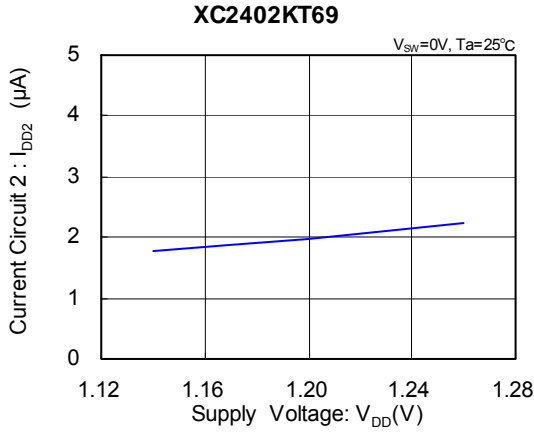

(31) Power Gain vs. Supply Voltage

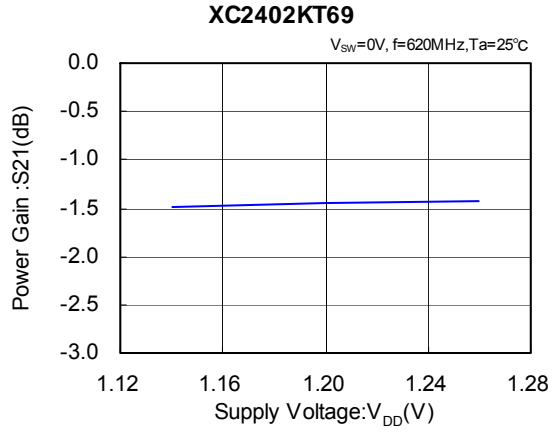

(32) Input Return Loss vs. Supply Voltage

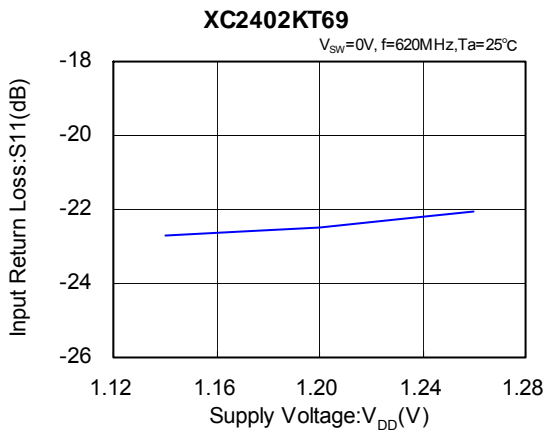

(33) Output Return Loss vs. Supply Voltage

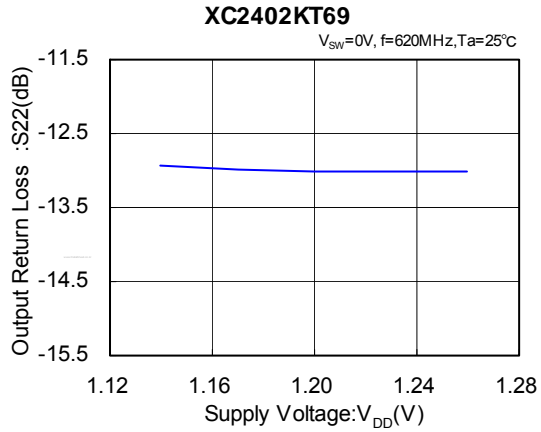

(34) Isolation vs. Supply Voltage

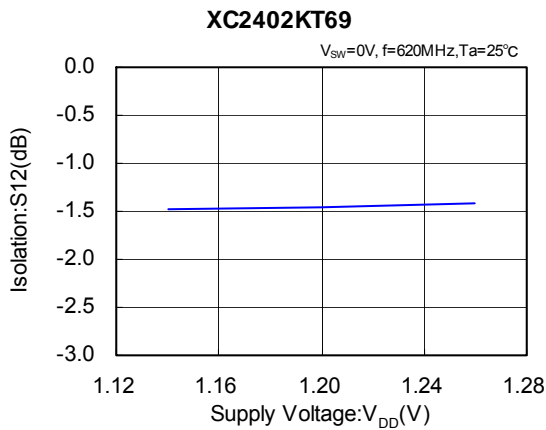

(35) Noise Figure vs. Supply Voltage

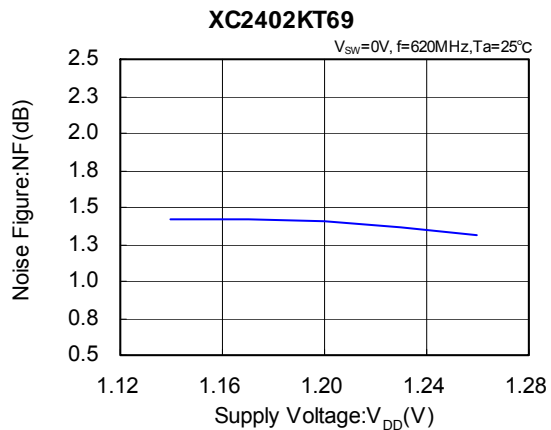



■ TYPICAL PERFORMANCE CHARACTERISTICS (Continued)

○ Low Gain Mode

(36) Input Power IP3 vs. Supply Voltage

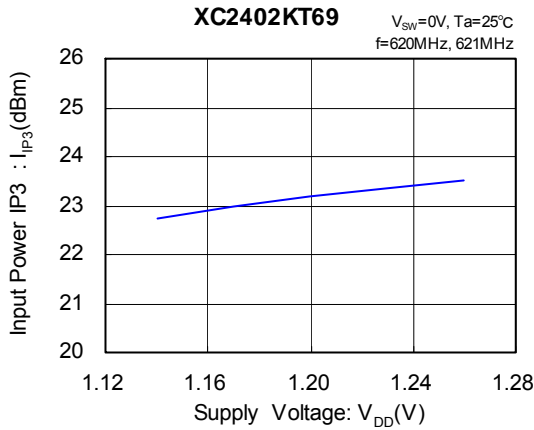

(37) Input Power @ 1dB Gain Compression vs. Supply Voltage

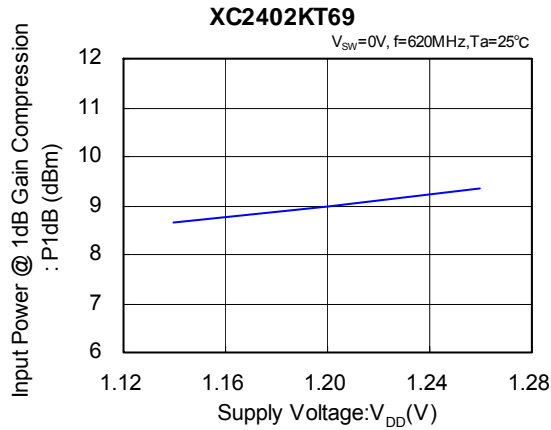

(38) Current Circuit 2 vs. Ambient Temperature

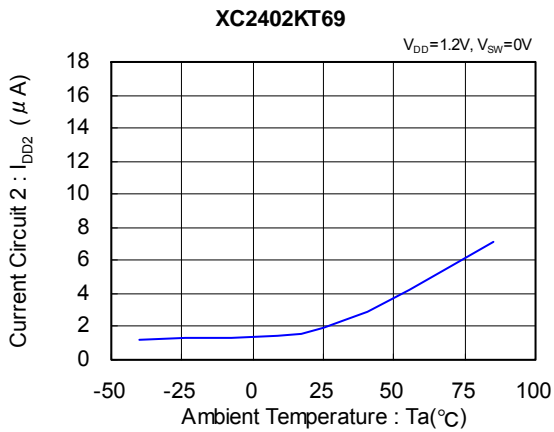

(39) Power Gain vs. Ambient Temperature

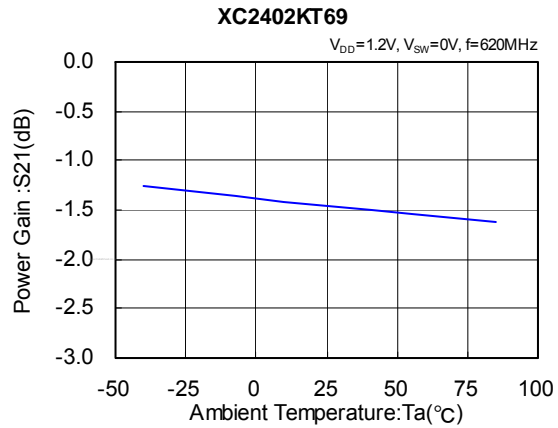

(40) Input Return Loss vs. Ambient Temperature

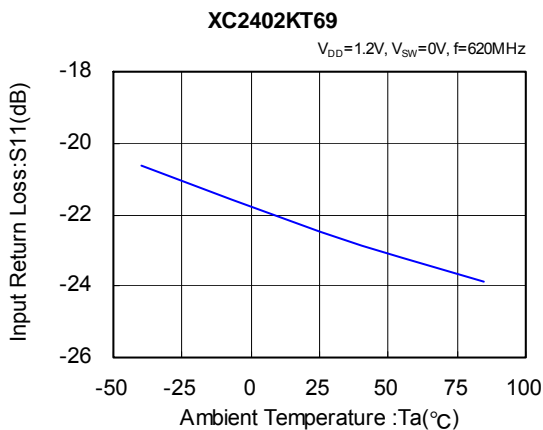

(41) Output Return Loss vs. Ambient Temperature

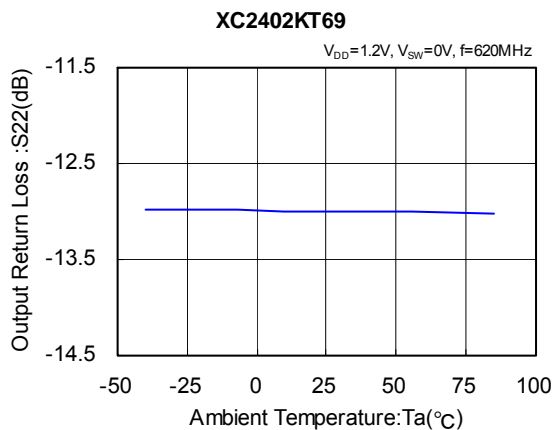

## TYPICAL PERFORMANCE CHARACTERISTICS (Continued)

### Low Gain Mode

(42) Isolation vs. Ambient Temperature

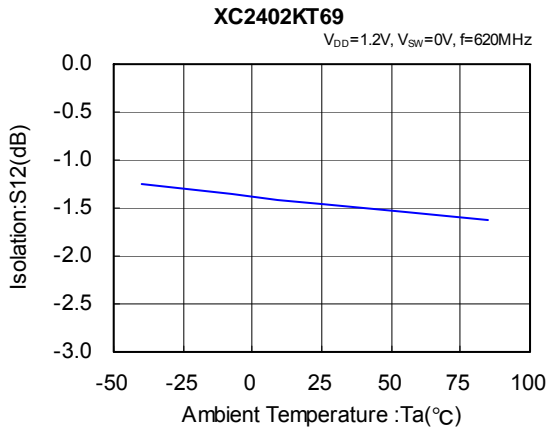

(43) Noise Figure vs. Ambient Temperature

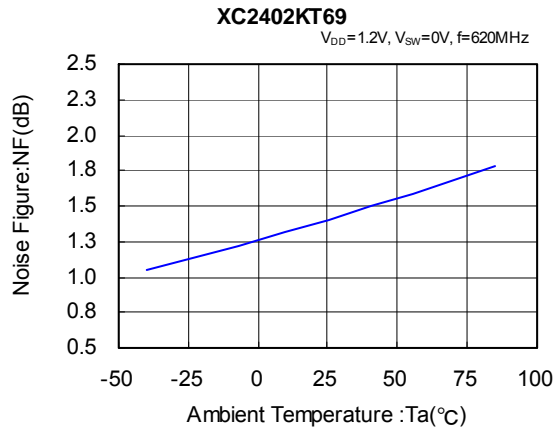

(44) Input Power IP3 vs. Ambient Temperature

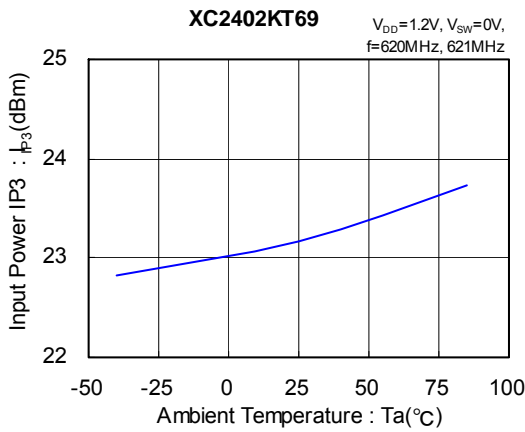

(45) Input Power @ 1dB Gain Compression vs. Ambient Temperature

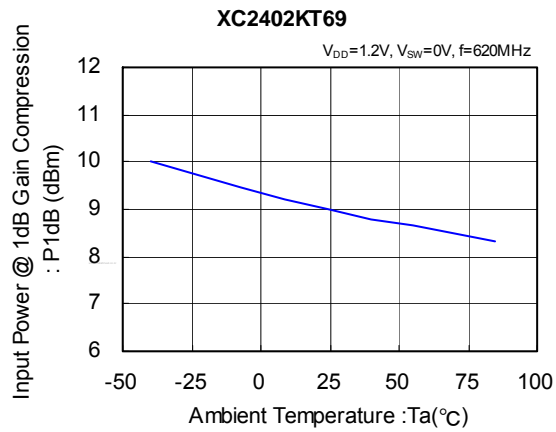

(46) Power Gain vs. Frequency

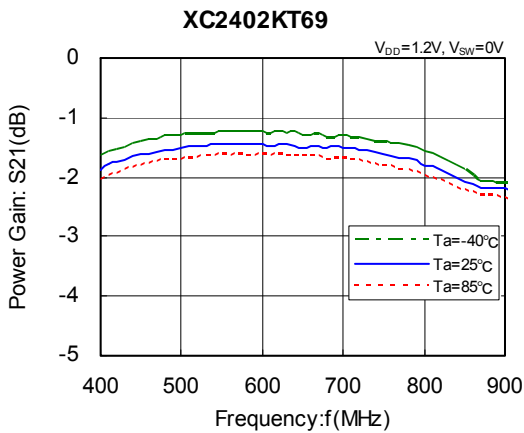

(47) Input Return Loss vs. Frequency

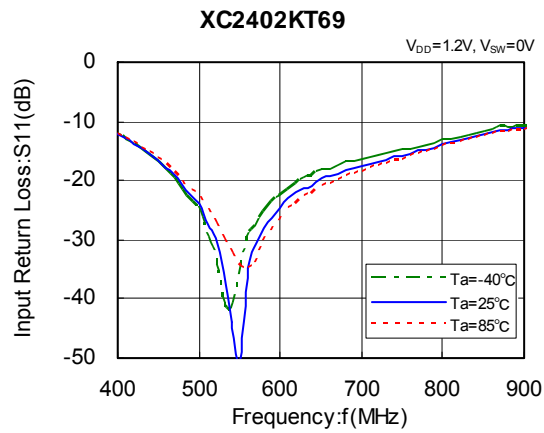

■ TYPICAL PERFORMANCE CHARACTERISTICS (Continued)

○ Low Gain Mode

(48) Output Return Loss vs. Frequency

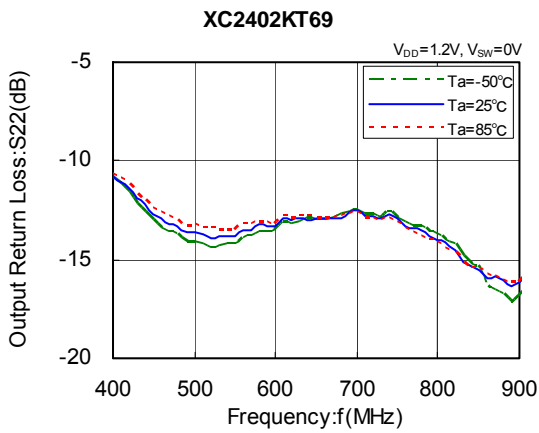

(49) Isolation vs. Frequency

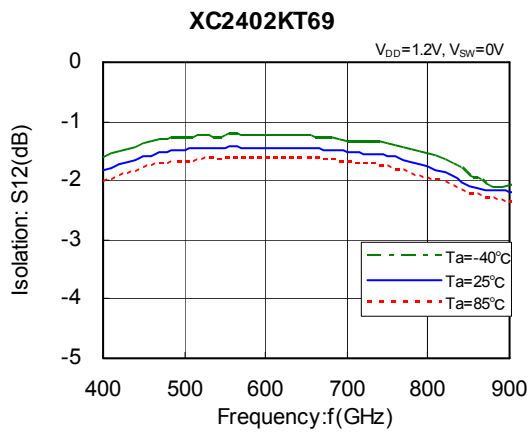

(50) Noise Figure vs. Frequency

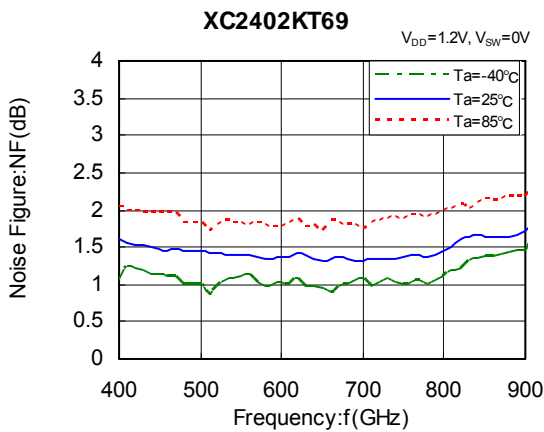

(51) Power Gain vs. Input Power

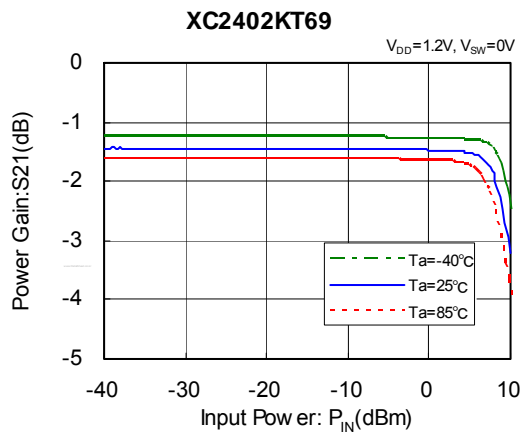

(52) Output Power / IM3 vs. Input Power

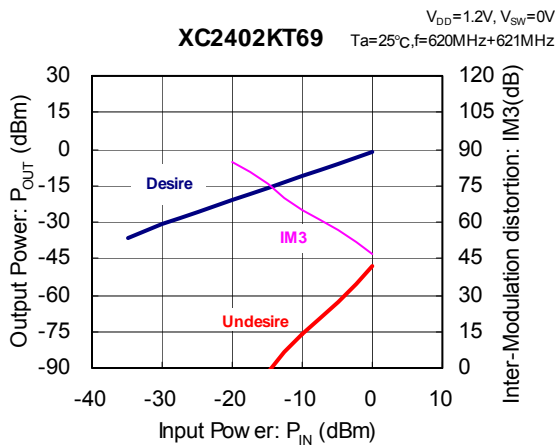

(53) Input Return Loss vs. Frequency (Smith Chart)

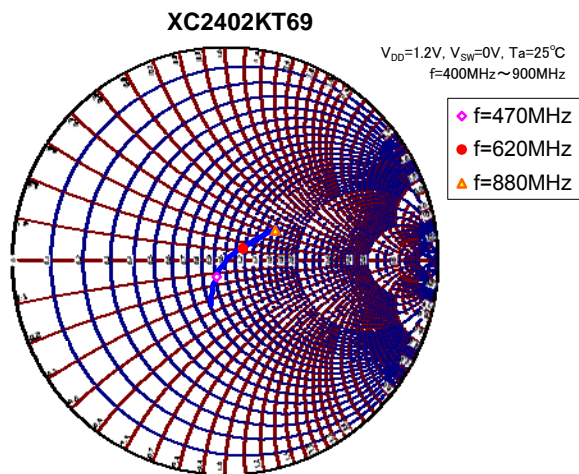

## TYPICAL PERFORMANCE CHARACTERISTICS (Continued)

○ Low Gain Mode

(54) Output Return Loss vs. Frequency (Smith Chart)

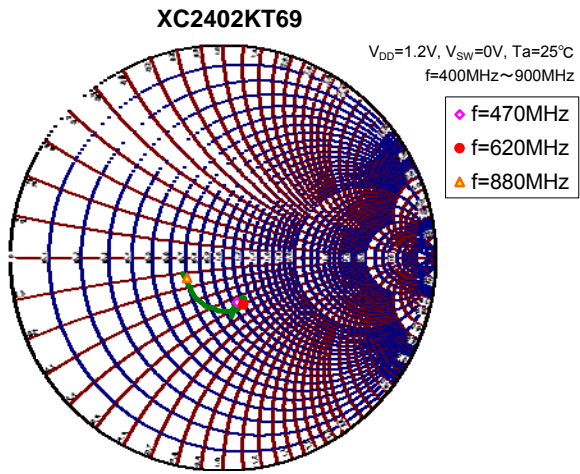



## PACKAGING INFORMATION (Continued)

### ●USP-8A01 Reference Pattern Layout (unit:mm)

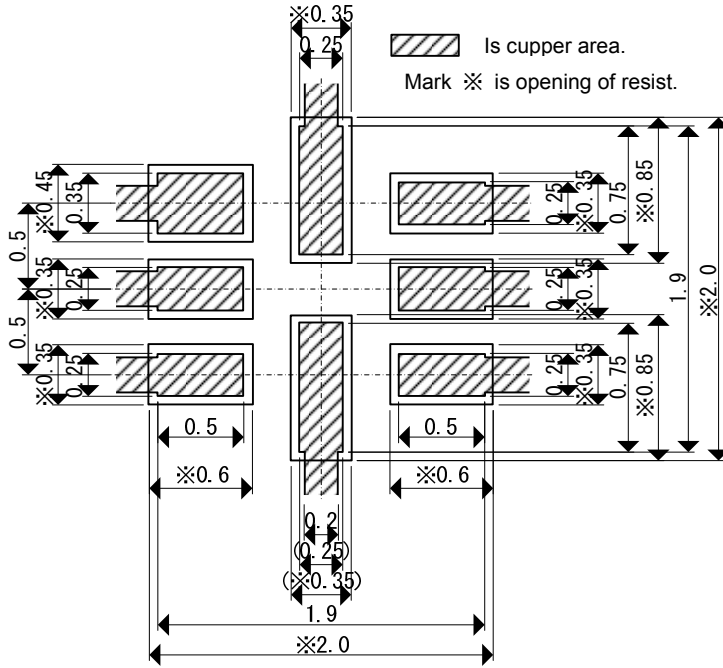

### ●USP-8A01 Reference Metal Mask Design (unit:mm)

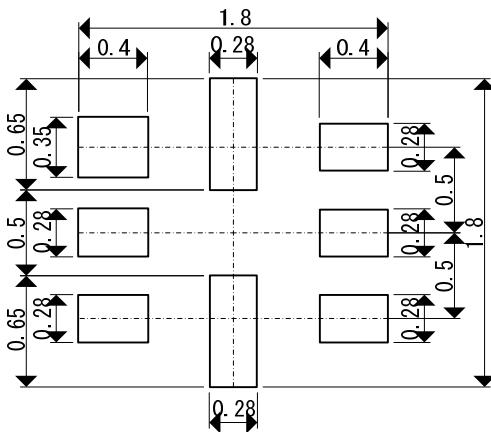

■ MARKING RULE

USP-8A01

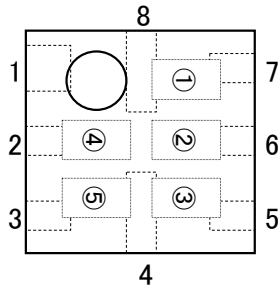

① represents product series.

MARK	PRODUCT SERIES
2	XC2402*****-G

② represents product.

MARK	PRODUCT SERIES
②	
K	XC2402K****-G

③ represents product.

MARK	PRODUCT SERIES
③	
T	XC2402*T****-G

④,⑤ represents production lot number.

01 to 09, 0A to 0Z, 11 to 9Z, A1 to A9, AA to AZ and B1 to ZZ in order.

(G, I, J, O, Q, W excepted)

\* No character inversion used.

1. The products and product specifications contained herein are subject to change without notice to improve performance characteristics. Consult us, or our representatives before use, to confirm that the information in this datasheet is up to date.
2. We assume no responsibility for any infringement of patents, patent rights, or other rights arising from the use of any information and circuitry in this datasheet.
3. Please ensure suitable shipping controls (including fail-safe designs and aging protection) are in force for equipment employing products listed in this datasheet.
4. The products in this datasheet are not developed, designed, or approved for use with such equipment whose failure or malfunction can be reasonably expected to directly endanger the life of, or cause significant injury to, the user.  
(e.g. Atomic energy; aerospace; transport; combustion and associated safety equipment thereof.)
5. Please use the products listed in this datasheet within the specified ranges.  
Should you wish to use the products under conditions exceeding the specifications, please consult us or our representatives.
6. We assume no responsibility for damage or loss due to abnormal use.
7. All rights reserved. No part of this datasheet may be copied or reproduced without the prior permission of TOREX SEMICONDUCTOR LTD.

**TOREX SEMICONDUCTOR LTD.**