

XC6706 Series

ETR03128-001a

20V input voltage, 200mA low supply current 1.2 μ A, high speed 3-pin voltage regulator

☆Green Operation compatible

GENERAL DESCRIPTION

The XC6706 series is a high-speed 3-pin LDO regulator IC using CMOS process. This series are low supply current 1.2 μ A, despite achieves high accuracy, and high ripple rejection.

Internal circuitry includes a reference voltage supply, error amplifier, Pch driver FET, current limit circuit, thermal shutdown circuit, and phase compensation circuit.

The output voltage is available in the fixed voltage types of 2.5V, 2.8V, 3.0V, 3.3V, 4.0V and 5.0V as standard products.

The XC6706 series is built-in with a soft start function to suppress inrush current and overshoot at startup. The series start up the output voltage in 1.0ms.

APPLICATION

- Industrial equipment
 - Smart meters, gas detectors, smoke detectors
 - Sensor / IoT devices
 - FA devices
- Domestic electrical appliances
- Consumer equipments
- Energy harvest
- Others
 - Devices with 2~4 Li-ion rechargeable battery directly connection
 - Devices with 2 Li-ion battery directly connection / 4 or more dry batteries

FEATURE

Low Supply Current	:	1.2 μ A
Operating Voltage Range	:	3.5V ~ 20.0V
Output Voltage Range	:	2.5V, 2.8V, 3.0V, 3.3V, 4.0V, 5.0V ^(*)
Accuracy	:	\pm 1.5%
Maximum Output Current	:	200mA
High Ripple Rejection	:	50dB @ 1kHz
Function	:	Seamless GO Soft-Start
Protection Function	:	Current Limit Thermal Shutdown
Input / output Capacitor	:	Ceramic capacitor
Package	:	SOT-89(4.5 x 4.6 x 1.6mm)
Operating Ambient Temperature	:	-40°C ~ 105°C
Environmentally Friendly	:	EU RoHS Compliant, Pd Free

^(*) Output voltages can be set internally from 2.5V to 5.5V (0.1V Increments).

For other voltages, please contact your local Torex sales office or distribution.

TYPICAL APPLICATION

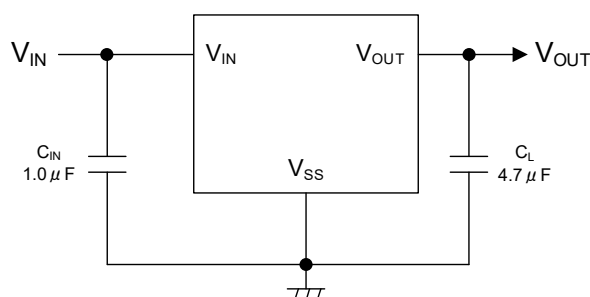

TYPICAL PERFORMANCE CHARACTERISTICS

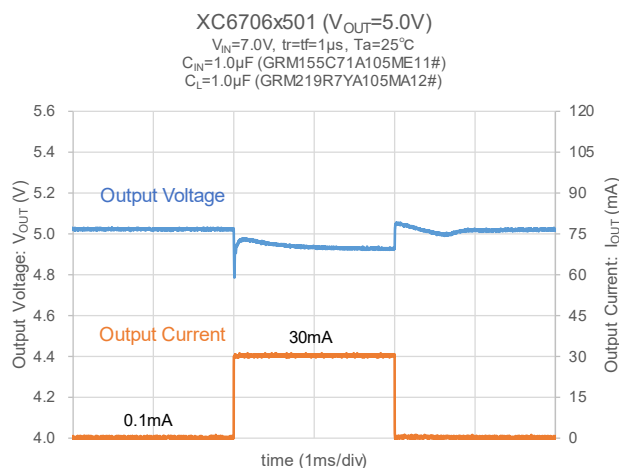

■ BLOCK DIAGRAMS

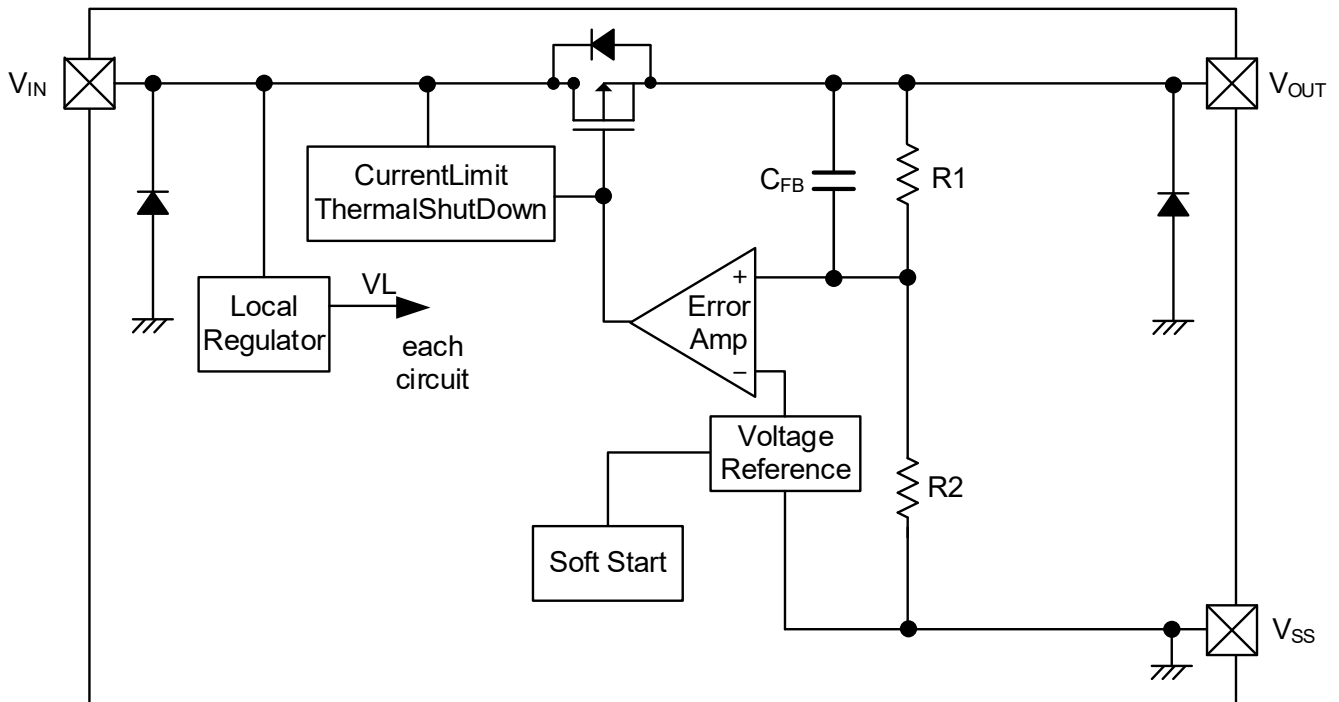

Diodes inside the circuits are ESD protection diodes and parasitic diodes.

■ PRODUCT CLASSIFICATION

● Ordering Information

XC6706①②③④⑤⑥-⑦^(*)

DESIGNATOR	ITEM	SYMBOL	DESCRIPTION
①	Type	C	-
②③	Output Voltage	25, 28, 30, 33, 40, 50 ^(*)	Output Voltage {x.xV} 25→2.5V, 28→2.8V, 30→3.0V, 33→3.3V 40→4.0V, 50→5.0V
④	Fixed No.	1	-
⑤⑥-⑦	Package (Order Unit)	PR-G ^(*)	SOT-89 (1,000pcs/Reel)

^(*) Output voltages can be set internally from 2.5V to 5.5V (0.1V Increments).

For other voltages, please contact your local Torex sales office or distribution.

^(*) "-G" suffix denotes Halogen and Antimony free as well as being fully EU RoHS compliant.

■ PIN CONFIGURATION

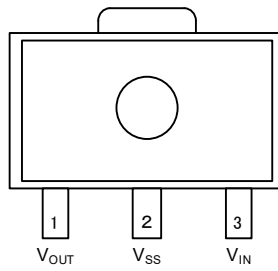

SOT-89
(TOP VIEW)

■ PIN ASSIGNMENT

PIN NUMBER	PIN NAME	FUNCTION
1	V _{OUT}	Output
2	V _{SS}	Ground
3	V _{IN}	Power Input

■ ABSOLUTE MAXIMUM RATINGS

PARAMETER	SYMBOL	RATINGS	UNITS
V _{IN} Pin Voltage	V _{IN}	-0.3 ~ 24.0	V
V _{OUT} Pin Voltage	V _{OUT}	-0.3 ~ V _{IN} + 0.3 or 6.5 ^{(*)1}	V
Power Dissipation (Ta=25°C)	Pd	1000 (40mm x 40mm Standard board) ^{(*)2}	mW
Junction Temperature	Tj	-40 ~ 125	°C
Storage Temperature	Tstg	-55 ~ 125	°C

All voltages are described based on the V_{SS}.

^{(*)1} The maximum rating corresponds to the lowest value between V_{IN}+0.3V or 6.5V.

^{(*)2} The power dissipation figure shown is PCB mounted and is for reference only.

Please refer to PACKAGING INFORMATION for the mounting condition.

■ RECOMMENDED OPERATING CONDITIONS

PARAMETER	SYMBOL	MIN.	TYP.	MAX.	UNITS	
V _{IN} Pin Voltage	V _{IN}	3.5	-	20.0	V	
Output Current ^{(*)2}	I _{OUT}	0	-	200	mA	
Operating Ambient Temperature	T _{opr}	-40	-	105	°C	
Input Capacitor (Effective Value)	C _{IN} ^(*)3,4)	0.4	1.0	Any	μF	
Output Capacitor (Effective Value)	C _L ^(*)3)	V _{OUT(T)} ^{(*)1} ≤ 2.9V	0.4	2.2	220	μF
		2.9V < V _{OUT(T)}	0.4	1.0	220	

All voltages are described based on the V_{SS}.

^{(*)1} V_{OUT(T)} : Nominal output voltage.

^{(*)2} Use within a range where the junction temperature does not exceed the maximum junction temperature.

^{(*)3} Some ceramic capacitors have an effective capacitance that is significantly lower than the nominal value due to the applied DC bias and ambient temperature. For the input / output capacitance of this IC, use an appropriate ceramic capacitor according to the DC bias usage conditions (ambient temperature, input / output voltage) so that the effective capacitance value is equal to or higher than the recommended component.

^{(*)4} If using a large-capacity capacitor such as an electrolytic capacitor or tantalum capacitor as the input capacitance, place a low ESR ceramic capacitor in parallel. If a ceramic capacitor is not placed, high-frequency voltage fluctuations will increase and the IC may malfunction.

ELECTRICAL CHARACTERISTICS

Ta=25°C

PARAMETER	SYMBOL	CONDITIONS	MIN.	TYP.	MAX.	UNIT	CIRCUIT
Input Voltage	V_{IN}		3.5	-	20.0	V	①
Output Voltage	$V_{OUT(E)}^{(*)}$	$I_{OUT}=10mA$	$V_{OUT(T)} \times 0.985$	$V_{OUT(T)}$	$V_{OUT(T)} \times 1.015$	V	①
Maximum Output Current	I_{OUTMAX}		200	-	-	mA	①
Load Regulation	ΔV_{OUT}	$V_{OUT@I_{OUT}=10mA}$ - $V_{OUT@I_{OUT}=100mA}$	0	$V_{OUT(T)} \times 0.007$	$V_{OUT(T)} \times 0.027$	V	①
Load Regulation2	ΔV_{OUT2}	$V_{OUT@I_{OUT}=0.01mA}$ - $V_{OUT@I_{OUT}=10mA}$	0	$V_{OUT(T)} \times 0.028$	$V_{OUT(T)} \times 0.05$		
Dropout Voltage	$V_{dif}^{(*)}$	$I_{OUT}=100mA$	-	E-1		V	①
Quiescent Current	I_{SS}	$I_{OUT}=0mA$	-	1.2	3.0	μA	②
Line Regulation	$\frac{\Delta V_{OUT}}{(\Delta V_{IN} \cdot V_{OUT})}$	$V_{OUT(T)+2V} \leq V_{IN} \leq 20V, I_{OUT}=10mA$	-	0.02	0.10	%/V	①
Output Voltage Temperature Characteristics	$\frac{\Delta V_{OUT}}{(\Delta T_{opr} \cdot V_{OUT})}$	$T_{opr_MIN} \leq T_{opr} \leq T_{opr_MAX}$	-	± 100	-	ppm/°C	①
Ripple Rejection	PSRR	$V_{IN} = \{V_{OUT(T)} + 2\}V_{DC} + 0.5V_{P-PAC}$ $I_{OUT}=30mA, f=1kHz$	-	50	-	dB	③
Current Limit	I_{LIM}	$V_{IN}=V_{OUT(T)}+3.0V$ $V_{OUT}=V_{OUT(T)} \times 0.95$	220	300	-	mA	①
Short-Circuit Current	I_{SHORT}	$V_{OUT}=V_{SS}$	-	30	-	mA	①
Soft-Start Time-	t_{SS}	$V_{IN} = 0V \rightarrow 8.5V$ The time by when V_{OUT} rises to $V_{OUT(T)} \times 0.9$	0.65	1.00	1.70	ms	①
Thermal Shutdown Detect Temperature	T_{TSD}	Junction Temperature $I_{OUT}=10mA$	-	165	-	°C	①
Thermal Shutdown Release Temperature	T_{TSR}	Junction Temperature	-	140	-	°C	①

Unless otherwise stated regarding input voltage conditions, $V_{IN} = V_{OUT(T)} + 2.0V$

(*) $V_{OUT(E)}$: Effective output voltage

(*) $V_{OUT(T)}$: Nominal output voltage

(*) $V_{dif} = \{ V_{IN1} - V_{OUT1} \}$

V_{IN1} : The input voltage when V_{OUT1} appears as input voltage is gradually decreased.

V_{OUT1} : A voltage equal to 98% of the output voltage whenever an amply stabilized V_{IN} and $I_{OUT}=10mA$ is input.

(*) Design value

■ **ELECTRICAL CHARACTERISTICS (Continued)**

● SPEC Table

SYMBOL	E-1	
NOMINAL OUTPUT VOLTAGE (V)	Dropout Voltage Vdif (V) I _{OUT} =100mA	
V _{OUT(T)}	TYP.	MAX.
2.5	0.53	0.81
2.6	0.52	
2.7	0.51	
2.8	0.50	
2.9	0.50	
3.0	0.49	
3.1	0.48	
3.2	0.48	
3.3	0.47	0.69
3.4	0.47	
3.5	0.47	
3.6	0.46	
3.7	0.46	
3.8	0.46	
3.9	0.46	
4.0	0.45	
4.1	0.45	0.66
4.2	0.45	
4.3	0.45	
4.4	0.44	
4.5	0.44	
4.6	0.44	
4.7	0.43	
4.8	0.43	
4.9	0.43	
5.0	0.43	
5.1	0.42	
5.2	0.42	
5.3	0.42	
5.4	0.41	
5.5	0.41	

TEST CIRCUITS

TEST CIRCUITS ①

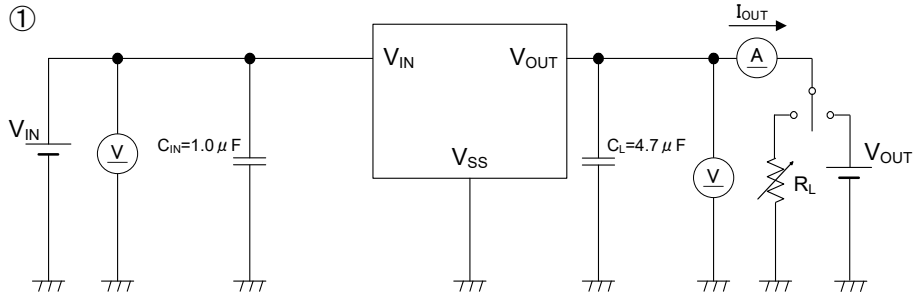

TEST CIRCUITS ②

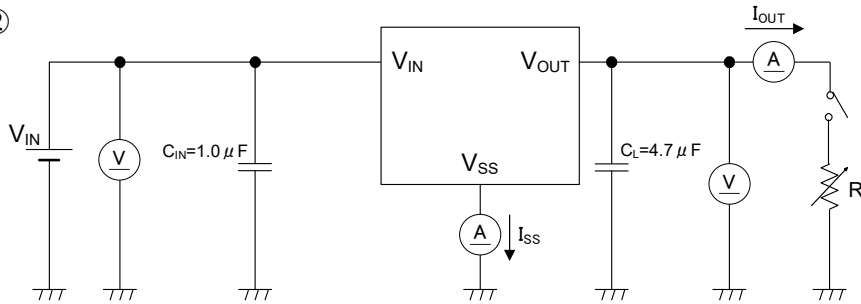

TEST CIRCUITS ③

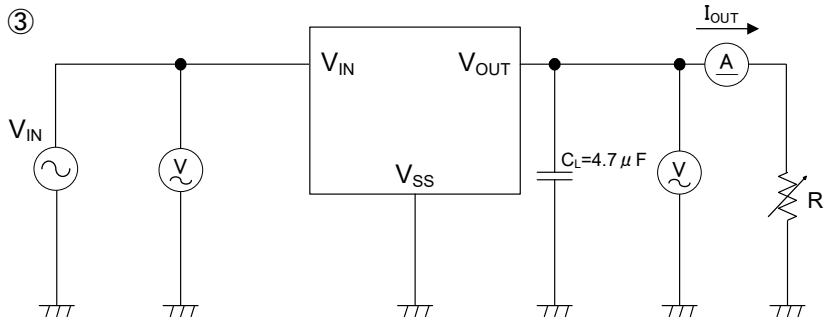

■ TYPICAL APPLICATION CIRCUIT

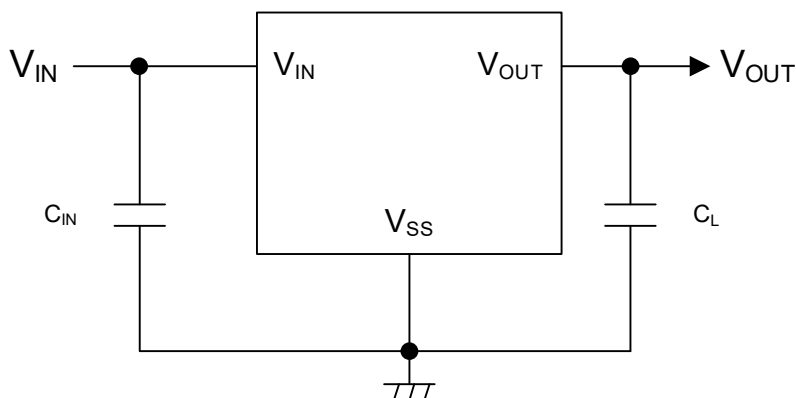

【Typical Examples】

	CONDITION	MANUFACTURER	PRODUCT NUMBER	VALUE	SIZE (L × W × T)
$C_{IN}^{(*1,2)}$	-	Murata	GRM219R7YA105MA12	1.0 μ F / 35V	2.0 × 1.25 × 0.85(mm)
$C_L^{(*1)}$	$V_{OUT(T)} \leq 2.9V$	Murata	GRM155C71A225ME11	2.2 μ F / 10V	1.0 × 0.5 × 0.5(mm)
	$2.9V < V_{OUT(T)}$	Murata	GRM155C71A105ME11	1.0 μ F / 10V	1.0 × 0.5 × 0.5(mm)

(*1) Some ceramic capacitors have an effective capacitance that is significantly lower than the nominal value due to the applied DC bias and ambient temperature. For the input / output capacitance of this IC, use an appropriate ceramic capacitor according to the DC bias usage conditions (ambient temperature, input / output voltage) so that the effective capacitance value is equal to or higher than the recommended component.

(*2) If using a large-capacity capacitor such as an electrolytic capacitor or tantalum capacitor as the input capacitance, place a low ESR ceramic capacitor in parallel. If a ceramic capacitor is not placed, high-frequency voltage fluctuations will increase and the IC may malfunction.

OPERATIONAL EXPLANATION

The voltage divided by resistors R1 & R2 is compared with the internal voltage reference by the error amplifier. The P-channel MOSFET, which is connected to the V_{IN} pin, is then driven by the subsequent output signal. The output voltage is controlled and stabilized by a system of negative feedback.

In addition, in order to improving the responsiveness of the error amplifier according to the output current, both low current consumption at light load and high-speed response at heavy load are achieved.

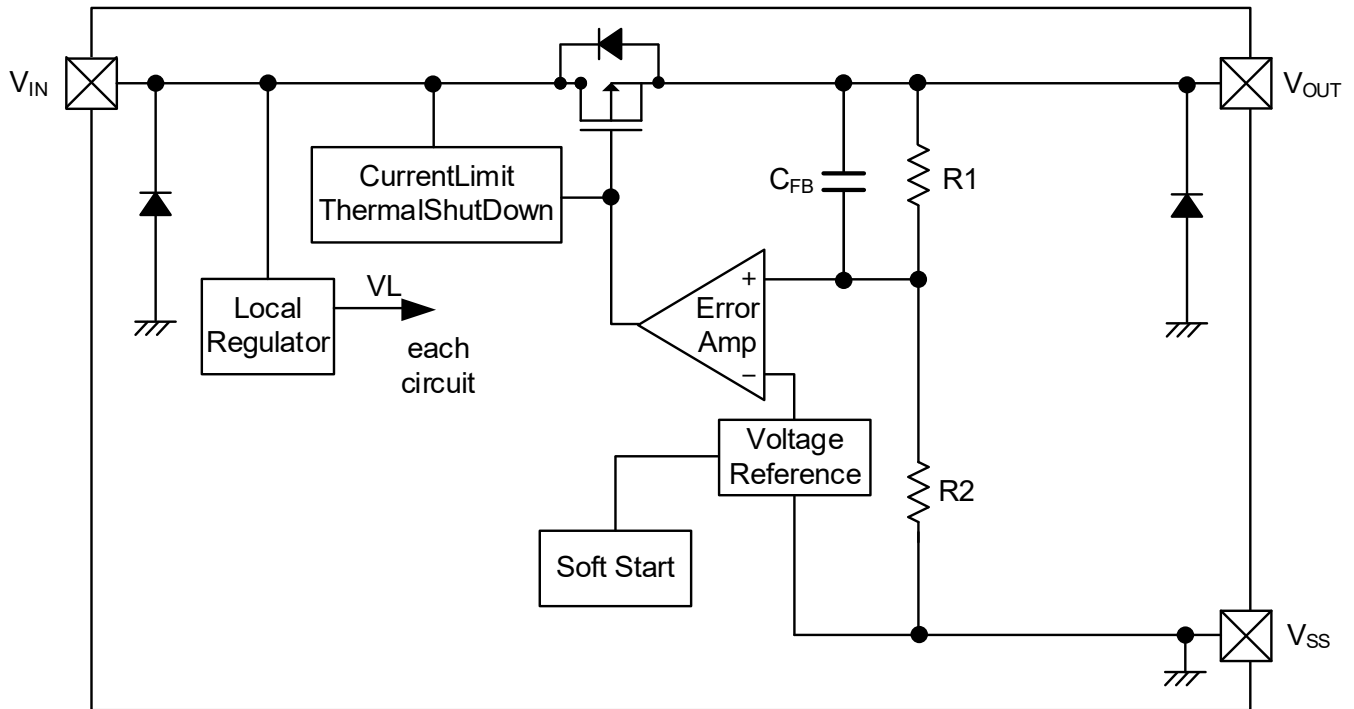

<Low ESR capacitor support>

An internal phase compensation circuit is incorporated in the XC6706 series to enable a stable output voltage to be obtained even when a low ESR capacitor is used. To stabilize the effect of the phase compensation circuit, always connect the output capacitor (C_L) in direct proximity to the V_{OUT} pin and V_{SS} pin. In addition, to stabilize the input power, connect the input capacitor (C_{IN}) in direct proximity to the V_{IN} pin and V_{SS} pin.

■ OPERATIONAL EXPLANATION(Continued)

<Startup operation : soft start>

This is a function to gently raise the output voltage and suppress the inrush current.

After inputting the V_{IN} , the reference voltage connected to the error amplifier is configured to linearly increase to the soft start period t_{SS} (TYP. 1.0ms). As a result, the output voltage rises in proportion to the increase in the reference voltage. This operation prevents the input current inrush and allows the output voltage to rise smoothly.

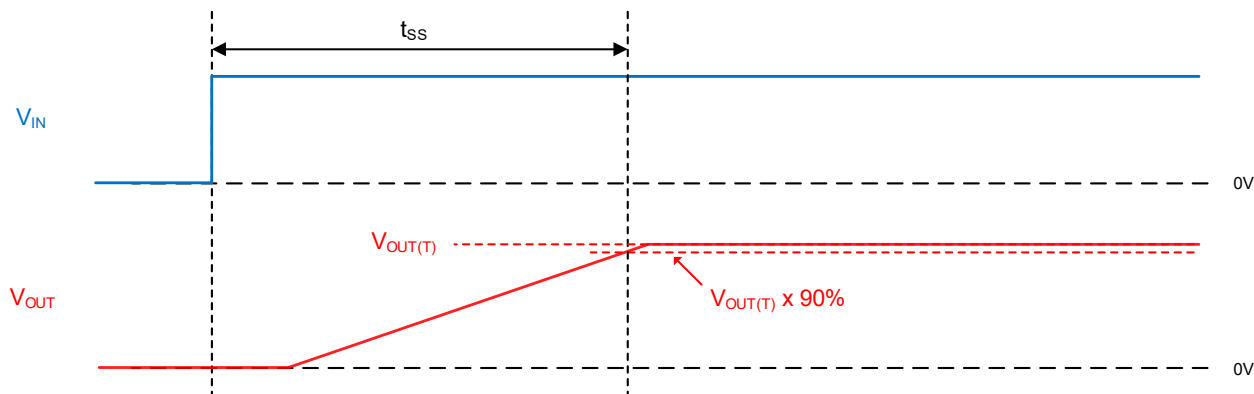

Output capacitor using at the large-capacity or heavy load

If a large-capacity output capacitor is used or a heavy load is applied during startup, the output voltage may not rise to the set output voltage during the soft start period.

If the output voltage does not rise to the set output voltage during the soft start period, the current limit function is activated to raise the output voltage.

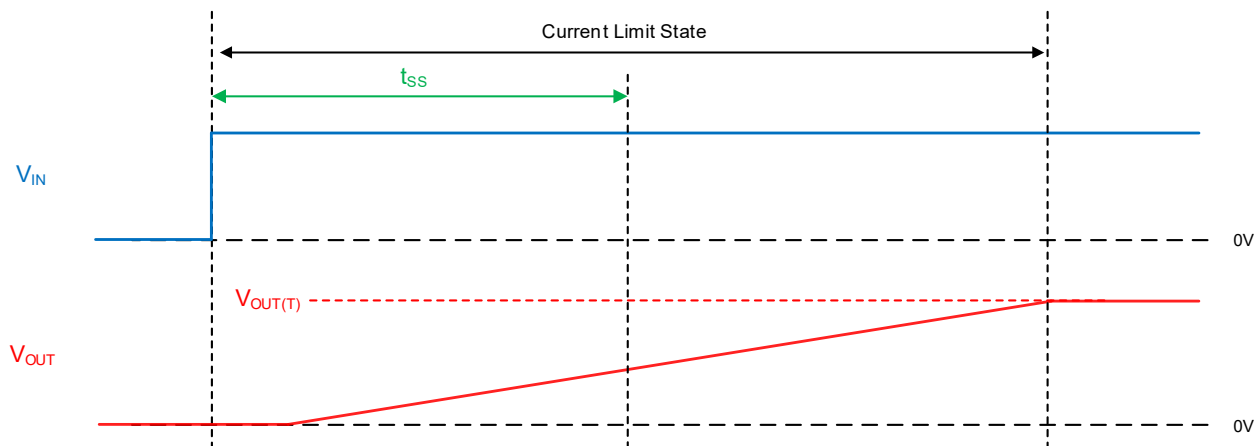

OPERATIONAL EXPLANATION(Continued)

<Current Limit>

The XC6706 series uses a current fold-back circuit as a current limit.

When the output current reaches I_{LIM} (TYP. 300mA), the current fold-back circuit operates. As a result, the output current also drops as the output voltage drops.

When the output voltage drops and the V_{OUT} pin is short-circuited, the output current is I_{SHORT} (TYP. 30mA).

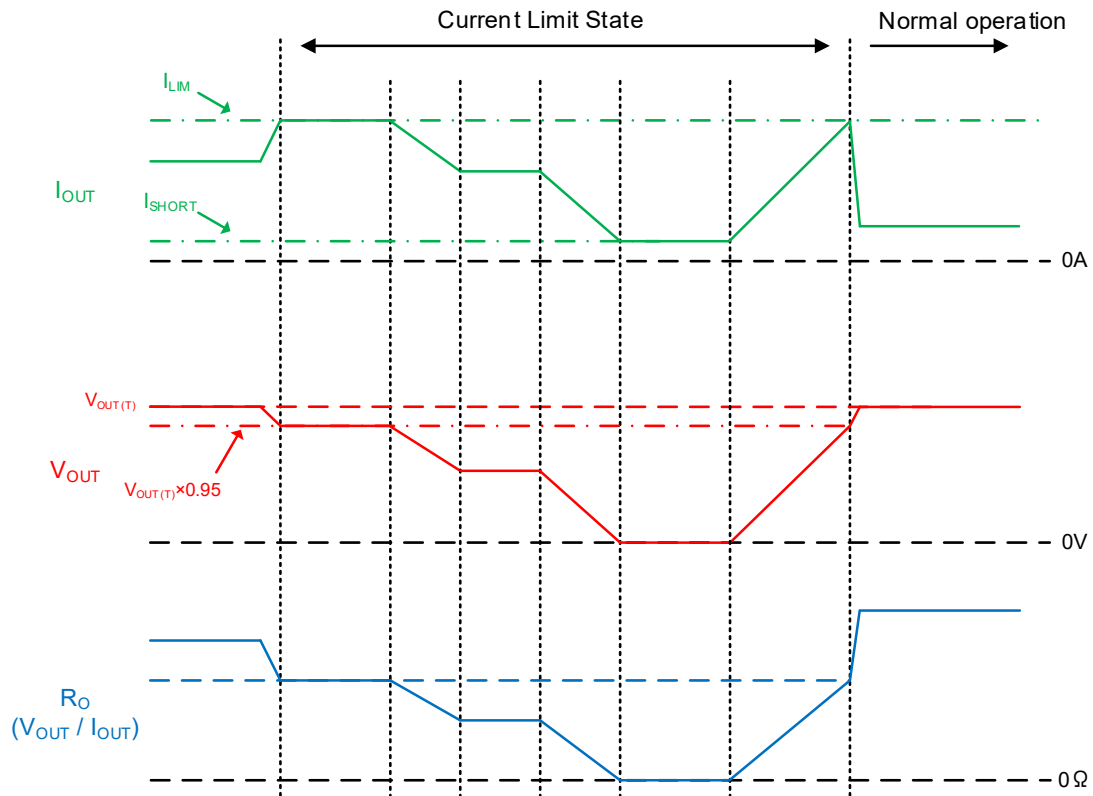

<Thermal shutdown circuit>

The XC6706 series incorporates a thermal shutdown circuit for overheating protection.

When the junction temperature reaches the detection temperature T_{TSD} (TYP. 165°C), the Pch driver FET is forcibly turned off. The thermal shutdown function operates and the Pch driver FET continues to be off. When the junction temperature falls to the release temperature (TYP. 140°C), the thermal shutdown function is canceled.

When the thermal shutdown function is canceled, the soft start function works to raise the output voltage.

If the output current is less than 10mA, in order to reduce the current consumption during light roads, reduce the supply current to the thermal shutdown circuit. If the output current is less than 10mA due to this operation, the thermal shutdown function will stop operating.

■ NOTES ON USE

1) For temporary, transitional voltage drop or voltage rising phenomenon, the IC is liable to malfunction should the ratings be exceeded.

Also, if IC is used under the conditions out of the recommended operating range, the IC may not operate normally or may cause deterioration.

2) The current limit function is operating even the output is started. If the IC is started with a current load that exceeds the fold-back curve, a start failure may occur due to the current limiting characteristics. In this case, after the output voltage rises to near the set output voltage, please control the sequence so that the load current is pulled.

3) Note on board layout

1. Where wiring impedance is high, operations may become unstable due to noise and/or phase lag depending on output current. Please strengthen V_{IN} and V_{SS} wiring in particular.

2. The input capacitor (C_{IN}) and the output capacitor (C_L) should be placed to the IC as close as possible.

4) The output voltage may become unstable near the maximum junction temperature.

5) Torex places an importance on improving our products and its reliability. However, by any possibility, we would request user all-safe design and post-aging treatment on system or equipment.

TYPICAL PERFORMANCE CHARACTERISTICS

(1) Quiescent Current vs. Input Voltage

(2) Quiescent Current vs. Ambient Temperature

(1-1) $V_{OUT(T)}=2.5V$

(2-1) $V_{OUT(T)}=2.5V$

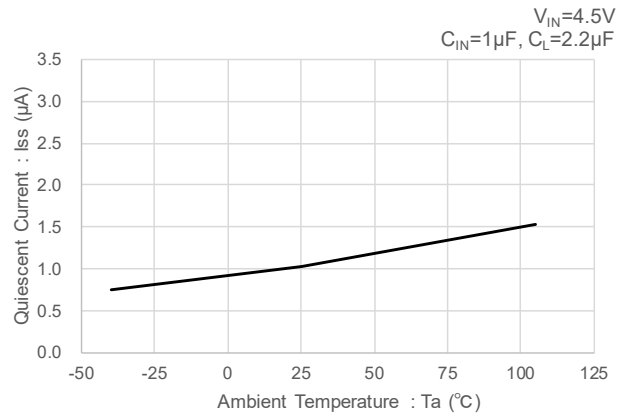
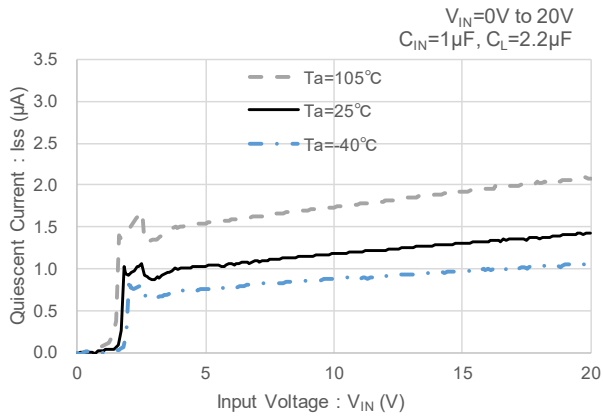

(1-2) $V_{OUT(T)}=3.3V$

(2-2) $V_{OUT(T)}=3.3V$

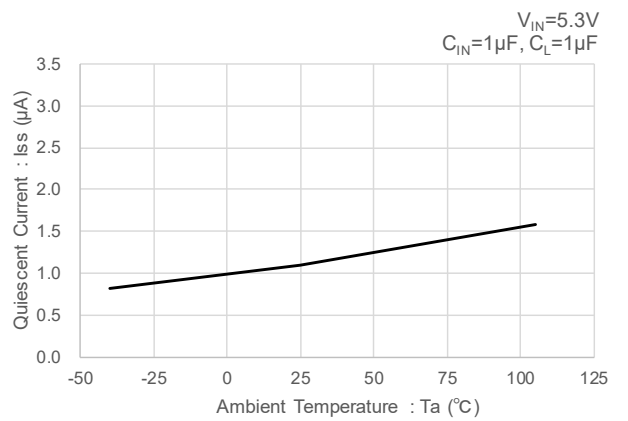
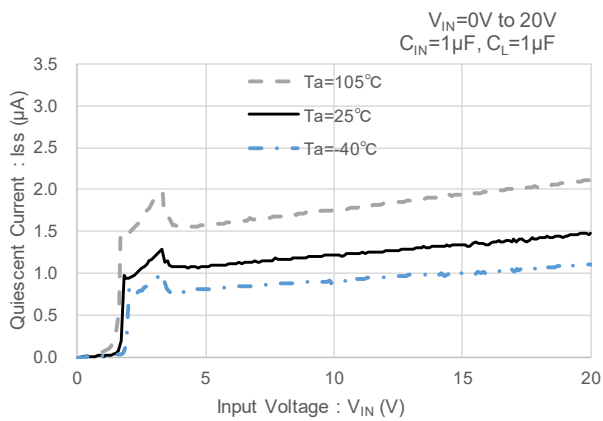

(1-3) $V_{OUT(T)}=5.5V$

(2-3) $V_{OUT(T)}=5.5V$

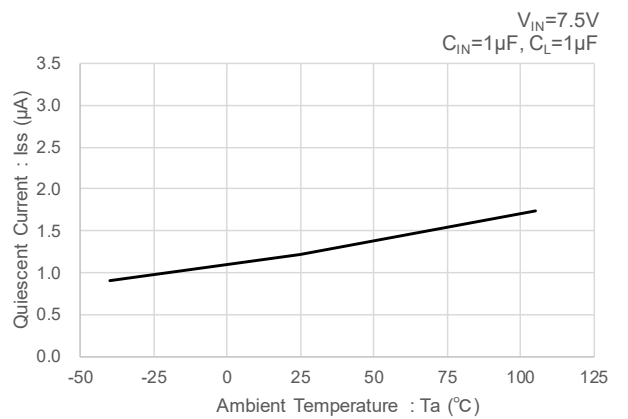
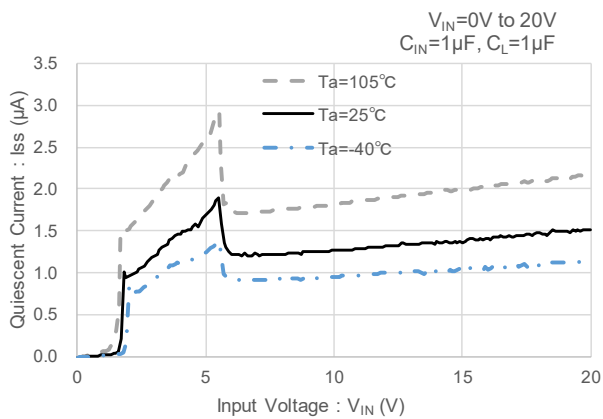

■ TYPICAL PERFORMANCE CHARACTERISTICS (Continued)

(3) Quiescent Current vs. Output Current

(3-1) $(I_{OUT} - I_{SS}) / I_{OUT}$ vs. Output Current ($V_{OUT(T)}=2.5V$)

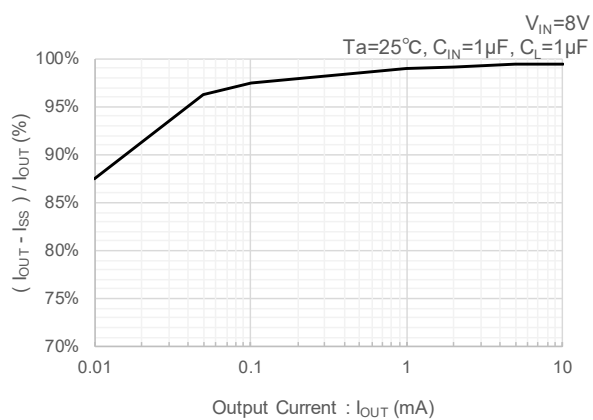

(3-2) Quiescent Current vs. Output Current ($V_{OUT(T)}=2.5V$)

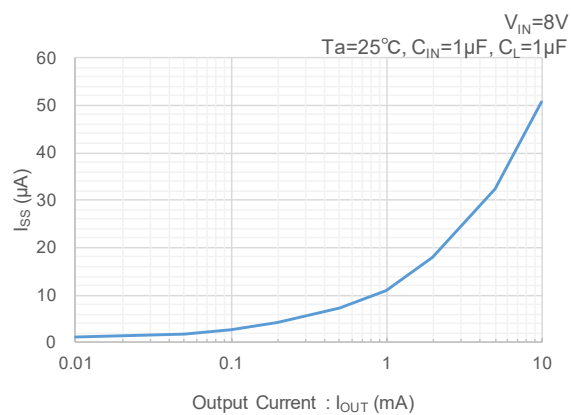

TYPICAL PERFORMANCE CHARACTERISTICS (Continued)

(4) Output Voltage vs. Input Voltage

(4-1) $V_{OUT(T)}=2.5V$

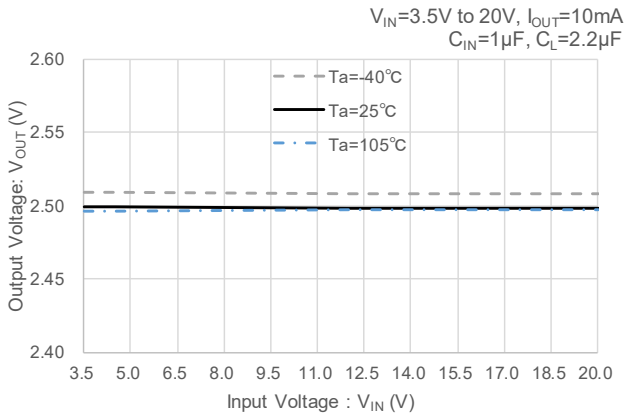

(5) Output Voltage vs. Ambient Temperature

(5-1) $V_{OUT(T)}=2.5V$

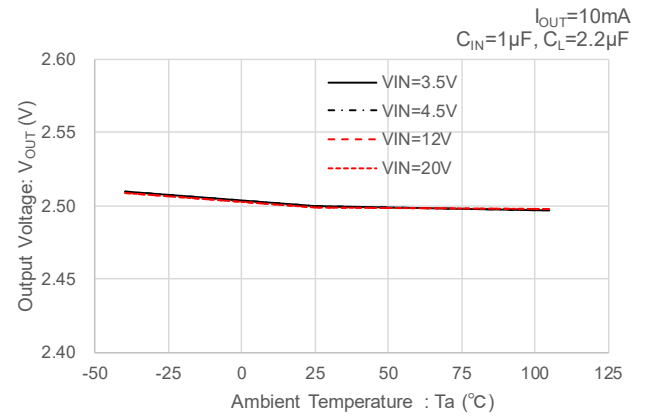

(4-2) $V_{OUT(T)}=3.3V$

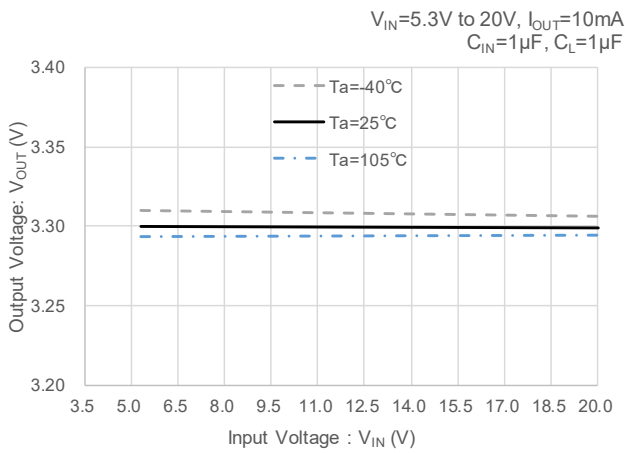

(5-2) $V_{OUT(T)}=3.3V$

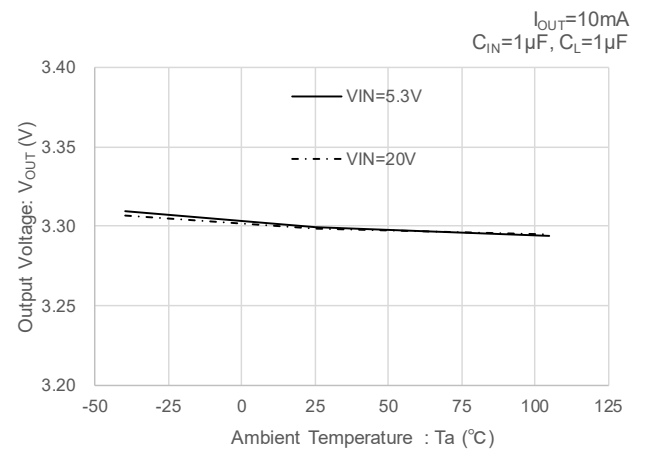

(4-3) $V_{OUT(T)}=5.5V$

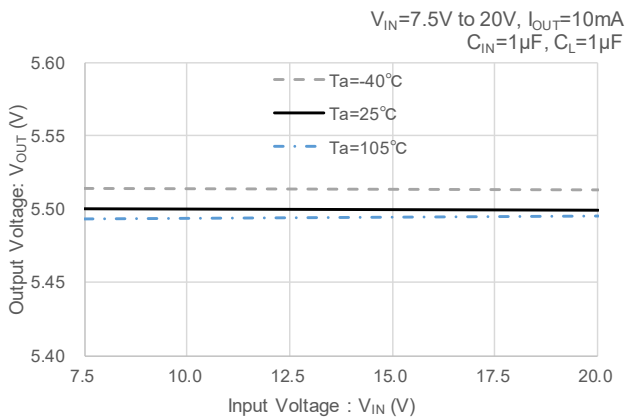

(5-3) $V_{OUT(T)}=5.5V$

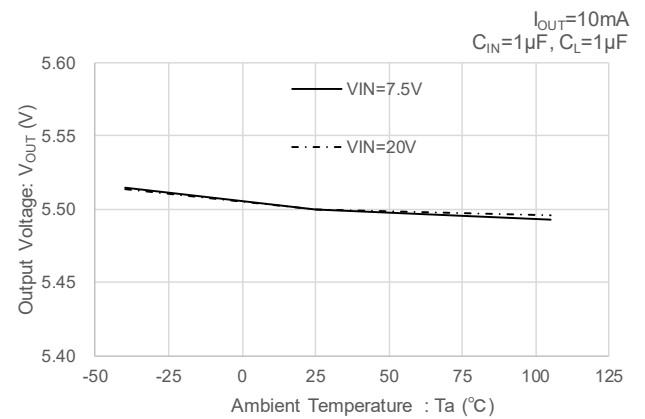

■ TYPICAL PERFORMANCE CHARACTERISTICS (Continued)

(6) Output Voltage vs. Output Current

(6-1) $V_{OUT(T)}=2.5V$

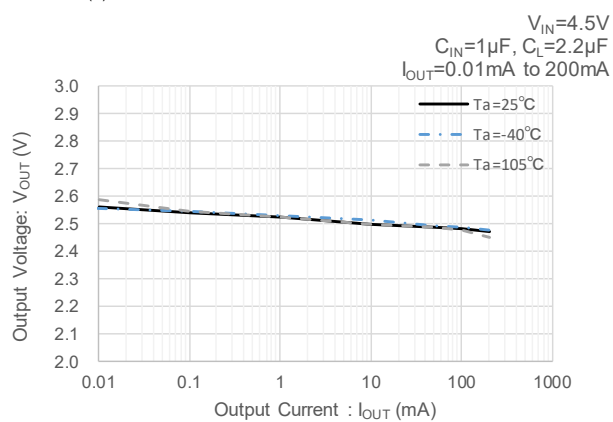

(6-2) $V_{OUT(T)}=3.3V$

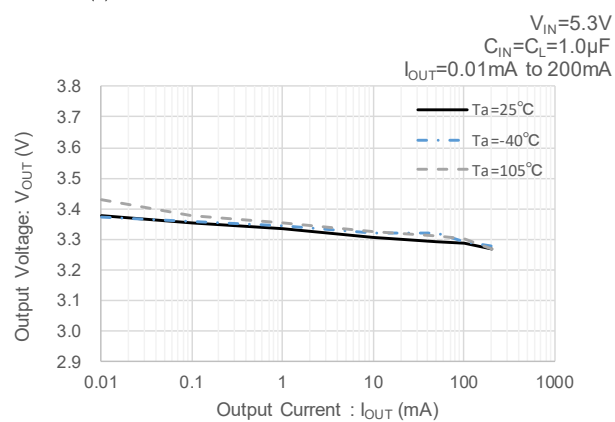

(6-3) $V_{OUT(T)}=5.5V$

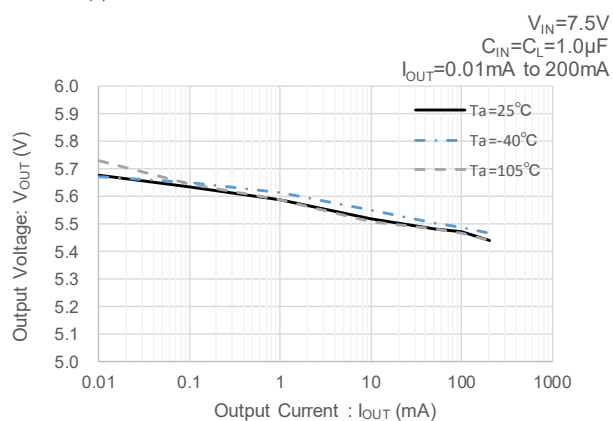

TYPICAL PERFORMANCE CHARACTERISTICS (Continued)

(7) Output Voltage vs. Output Current (Current Limit)

(7-1) $V_{OUT(T)}=2.5V$

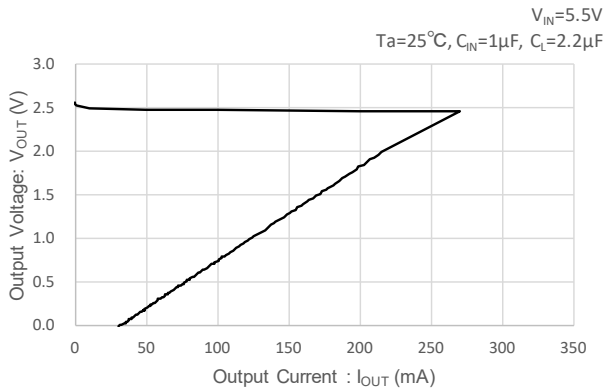

(7-2) $V_{OUT(T)}=3.3V$

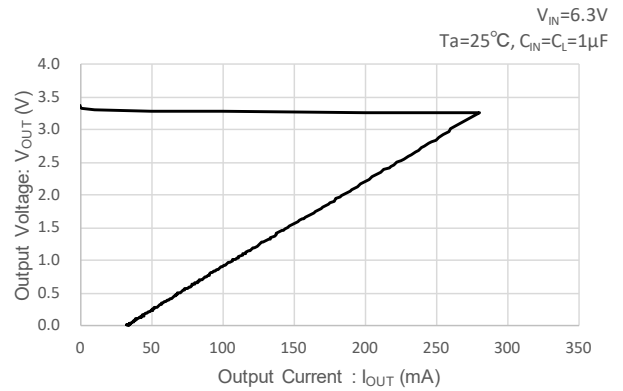

(7-3) $V_{OUT(T)}=5.5V$

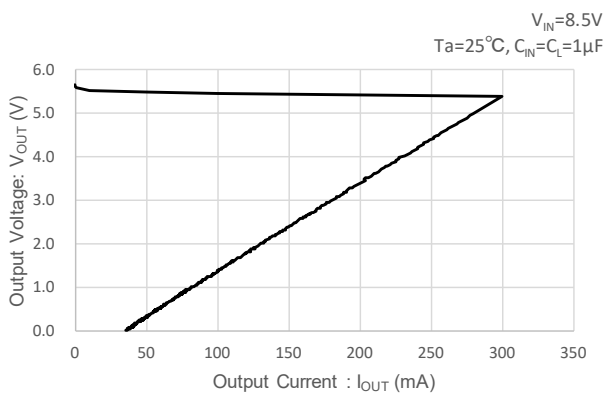

■ TYPICAL PERFORMANCE CHARACTERISTICS (Continued)

(8) Dropout Voltage vs. Output Current

(8-1) $V_{OUT(T)}=2.5V$

$C_{IN}=1.0\mu F, C_L=2.2\mu F$
 $I_{OUT}=0.01mA, 100mA, 200mA$

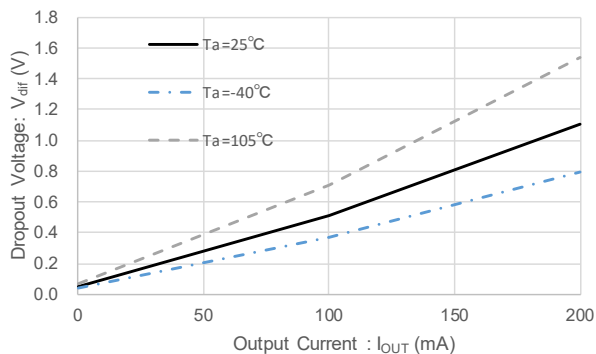

(8-2) $V_{OUT(T)}=3.3V$

$C_{IN}=C_L=1.0\mu F$
 $I_{OUT}=0.01mA, 100mA, 200mA$

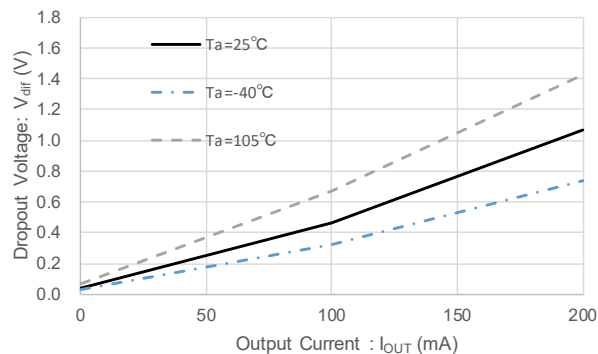

(8-3) $V_{OUT(T)}=5.5V$

$C_{IN}=C_L=1.0\mu F$
 $I_{OUT}=0.01mA, 100mA, 200mA$

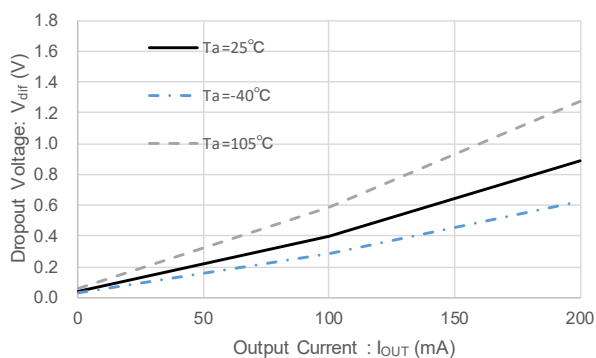

(9) Soft-Start Time vs. Ambient Temperature

(9-1) $V_{OUT(T)}=2.5V$

$V_{IN}=8.5V, V_{IN}=0V \rightarrow 1.4V$
 $I_{OUT}=10mA$
 $C_{IN}=1\mu F$ (GRM219R7YA105MA12)
 $C_L=2.2\mu F$ (GRM155C71A225ME11)

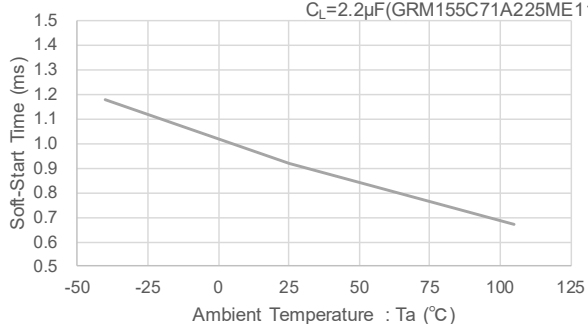

TYPICAL PERFORMANCE CHARACTERISTICS (Continued)

(10) Input Voltage Rising Response

(10-1) $V_{OUT(T)}=2.5V$

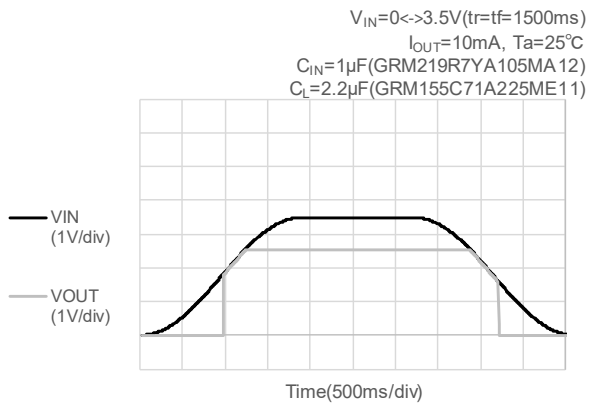

(10-2) $V_{OUT(T)}=3.3V$

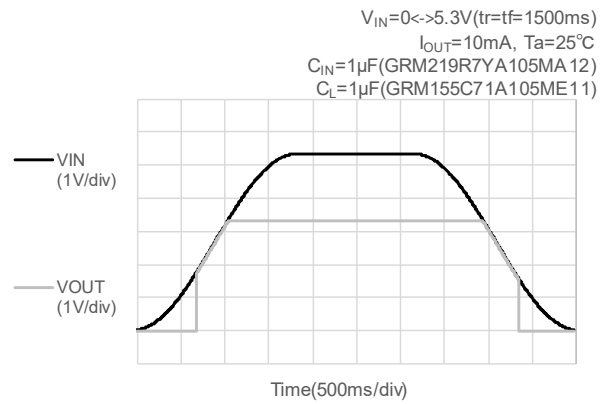

(10-3) $V_{OUT(T)}=5.5V$

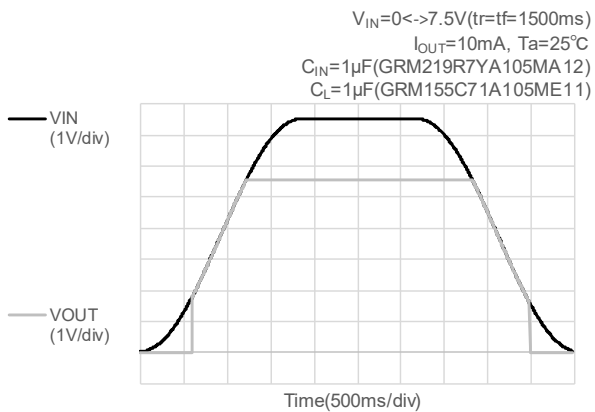

■ TYPICAL PERFORMANCE CHARACTERISTICS (Continued)

(11) Input Voltage Transient Response

(11-1) $V_{OUT(\tau)}=2.5V$

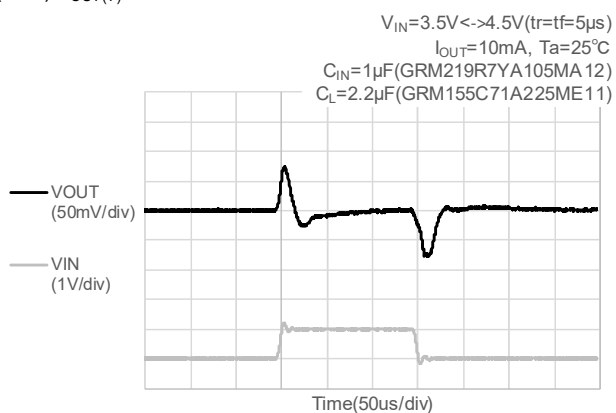

(11-2) $V_{OUT(\tau)}=3.3V$

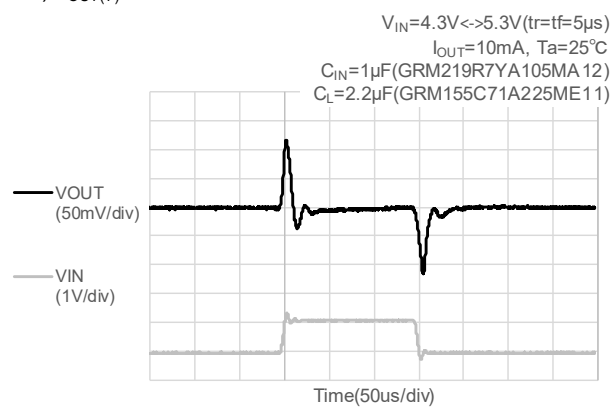

(11-3) $V_{OUT(\tau)}=5.5V$

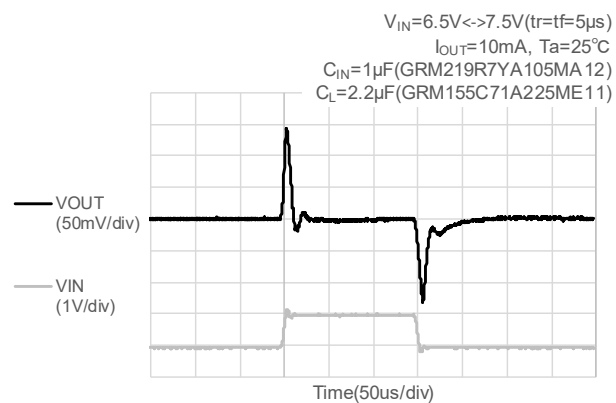

TYPICAL PERFORMANCE CHARACTERISTICS (Continued)

(12) Load Transient Response1

(12-1-1) $V_{OUT(T)}=2.5V$ (Rising Edge)

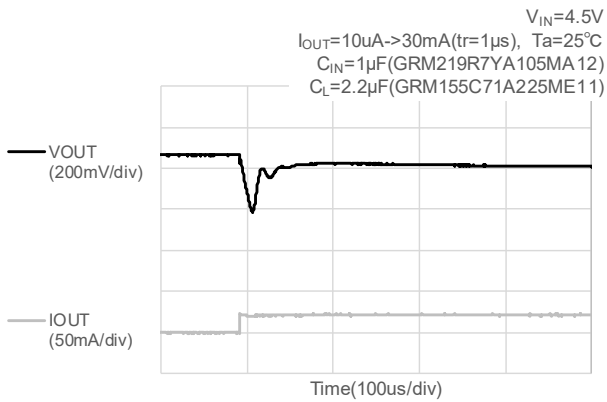

(12-1-2) $V_{OUT(T)}=2.5V$ (Falling Edge)

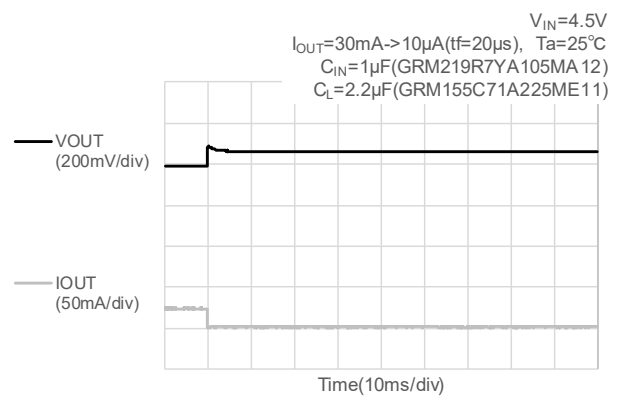

(12-2-1) $V_{OUT(T)}=5.5V$ (Rising Edge)

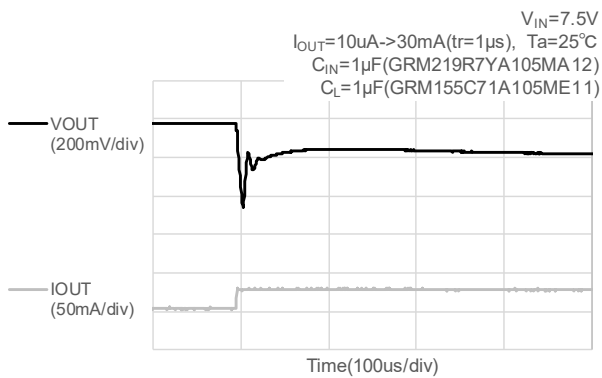

(12-2-2) $V_{OUT(T)}=5.5V$ (Falling Edge)

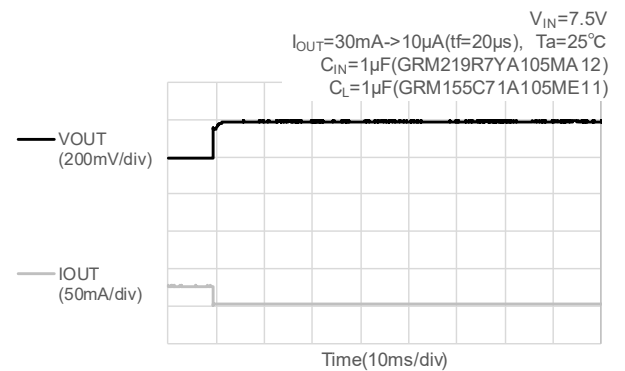

■ TYPICAL PERFORMANCE CHARACTERISTICS (Continued)

(13) Load Transient Response2

(13-1-1) $V_{OUT(T)}=2.5V$ (Rising Edge)

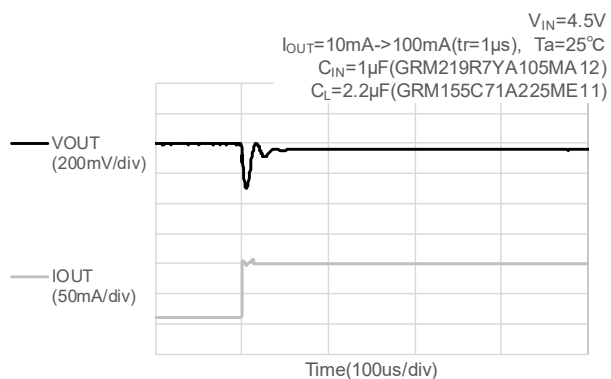

(13-1-2) $V_{OUT(T)}=2.5V$ (Falling Edge)

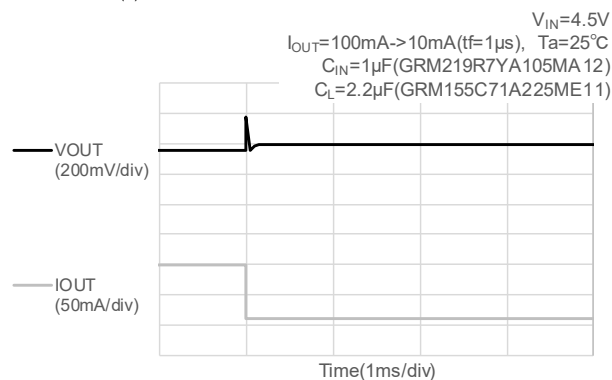

(13-2-1) $V_{OUT(T)}=5.5V$ (Rising Edge)

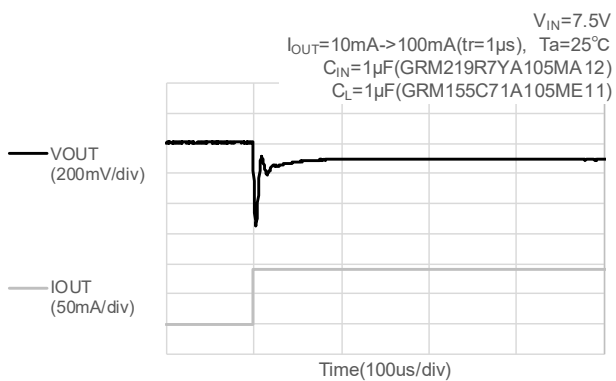

(13-2-2) $V_{OUT(T)}=5.5V$ (Falling Edge)

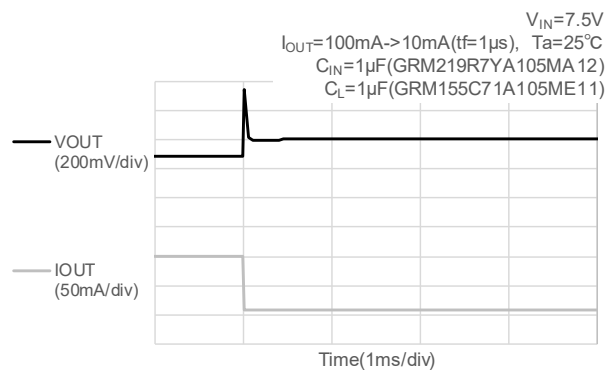

TYPICAL PERFORMANCE CHARACTERISTICS (Continued)

(14) Power Supply Rejection Ratio

(14-1) $V_{OUT(T)}=2.5V$

$V_{IN}=4.5V+0.5Vp-pAC$, $I_{OUT}=30mA$
 $C_{IN}=1\mu F(GRM219R7YA105MA12)$
 $C_L=2.2\mu F(GRM155C71A225ME11)$

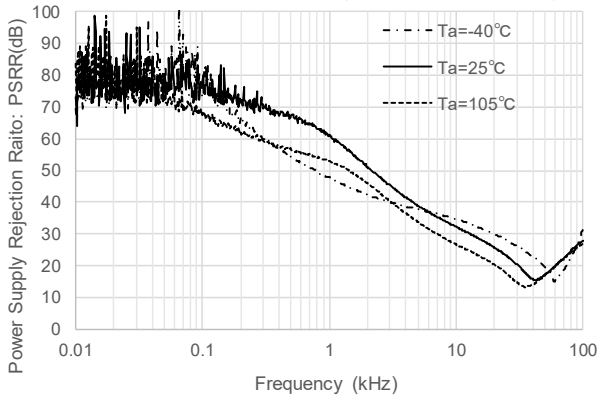

(14-2) $V_{OUT(T)}=3.3V$

$V_{IN}=5.3V+0.5Vp-pAC$, $I_{OUT}=30mA$
 $C_{IN}=1\mu F(GRM219R7YA105MA12)$
 $C_L=1\mu F(GRM155C71A105ME11)$

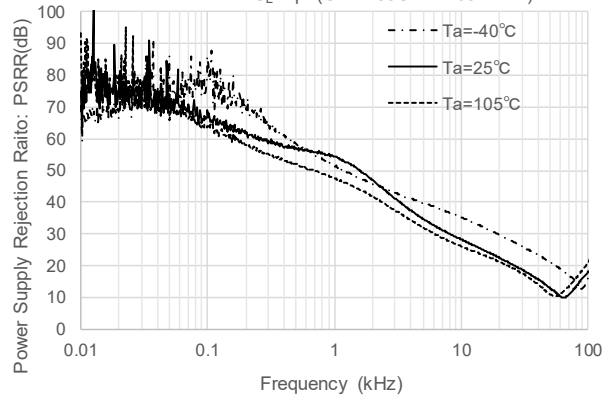

(14-3) $V_{OUT(T)}=5.5V$

$V_{IN}=7.5V+0.5Vp-pAC$, $I_{OUT}=30mA$
 $C_{IN}=1\mu F(GRM219R7YA105MA12)$
 $C_L=1\mu F(GRM155C71A105ME11)$

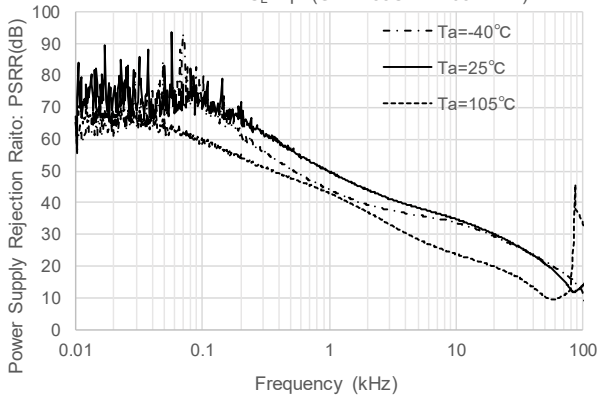

(15) Output Noise Density

(15-1) XC6706A331P ($V_{OUT(T)}=3.3V$)

$V_{IN}=V_{OUT(T)}+2.0V$, $T_a=25^\circ C$
 $C_{IN}=1\mu F(GRM219R7YA105MA12)$
 $C_L=1\mu F(GRM155C71A105ME11)$

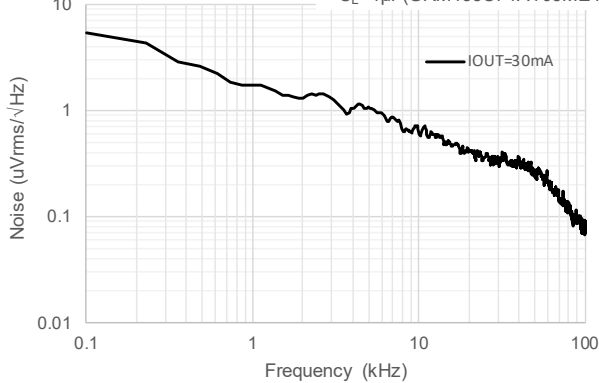

■ PACKAGING INFORMATION

For the latest package information go to, www.torexsemi.com/technical-support/packages

PACKAGE	OUTLINE / LAND PATTERN	THERMAL CHARACTERISTICS
SOT-89	SOT-89 PKG	SOT-89 Power Dissipation

MARKING RULE

● SOT-89

MARK① Represents products series

MARK	PRODUCT SERIESIES
P	XC6706****P*-G

MARK② Represents type, output voltage range

MARK	Type	Output Voltage Range (V)	PRODUCT SERIESIES
A	C	2.5~3.6	XC6706C***P*-G
B		3.7~4.8	
C		4.9~5.5	

SOT-89

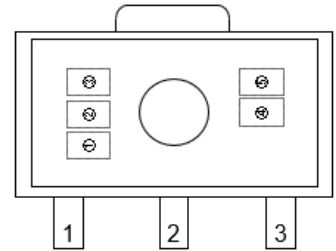

MARK③ Represents output voltage

MARK	OUTPUT VOLTAGE (V)			MARK	OUTPUT VOLTAGE (V)		
0	2.5	3.7	4.9	6	3.1	4.3	5.5
1	2.6	3.8	5.0	7	3.2	4.4	
2	2.7	3.9	5.1	8	3.3	4.5	
3	2.8	4.0	5.2	9	3.4	4.6	
4	2.9	4.1	5.3	A	3.5	4.7	
5	3.0	4.2	5.4	B	3.6	4.8	

MARK④,⑤ represents production lot number

01~09, 0A~0Z, 11~9Z, A1~A9, AA~Z9, ZA~ZZ in order. (G, I, J, O, Q, W excluded)

* No character inversion used.

1. The product and product specifications contained herein are subject to change without notice to improve performance characteristics. Consult us, or our representatives before use, to confirm that the information in this datasheet is up to date.
2. The information in this datasheet is intended to illustrate the operation and characteristics of our products. We neither make warranties or representations with respect to the accuracy or completeness of the information contained in this datasheet nor grant any license to any intellectual property rights of ours or any third party concerning with the information in this datasheet.
3. Applicable export control laws and regulations should be complied and the procedures required by such laws and regulations should also be followed, when the product or any information contained in this datasheet is exported.
4. The product is neither intended nor warranted for use in equipment of systems which require extremely high levels of quality and/or reliability and/or a malfunction or failure which may cause loss of human life, bodily injury, serious property damage including but not limited to devices or equipment used in 1) nuclear facilities, 2) aerospace industry, 3) medical facilities, 4) automobile industry and other transportation industry and 5) safety devices and safety equipment to control combustions and explosions. Do not use the product for the above use unless agreed by us in writing in advance.
5. Although we make continuous efforts to improve the quality and reliability of our products; nevertheless Semiconductors are likely to fail with a certain probability. So in order to prevent personal injury and/or property damage resulting from such failure, customers are required to incorporate adequate safety measures in their designs, such as system fail safes, redundancy and fire prevention features.
6. Our products are not designed to be Radiation-resistant.
7. Please use the product listed in this datasheet within the specified ranges.
8. We assume no responsibility for damage or loss due to abnormal use.
9. All rights reserved. No part of this datasheet may be copied or reproduced unless agreed by Torex Semiconductor Ltd in writing in advance.

TOREX SEMICONDUCTOR LTD.