

Synchronous Step-Down DC/DC Converters

GreenOperation Compatible

GENERAL DESCRIPTION

The XC9225/XC9226/XC9227 series is a group of synchronous-rectification type DC/DC converters with a built-in 0.6 P-channel driver transistor and 0.7 N-channel switching transistor, designed to allow the use of ceramic capacitors. The ICs enable a high efficiency, stable power supply with an output current of 500mA (A~D series) and 600mA (E~H series) to be configured using only a coil and two capacitors connected externally. Minimum operating voltage is 2.0V~6.0V (A~D series), 4.5V~5.5V (E~H series). Output voltage is internally programmable in a range from 0.9V to 4.0V (A~D series) and 3.0~4.0V (E~H series) in increments of 0.05V (accuracy: $\pm 2.0\%$). With the built-in oscillator, oscillation frequency is selectable from 600kHz and 1.2MHz to make available the frequency best suited to your particular application. As for operation mode, the XC9225 series is PWM control, the XC9226 series is automatic PWM/PFM switching control and the XC9227 series can be manually switched between the PWM control mode and the automatic PWM/PFM switching control mode, allowing fast response, low ripple and high efficiency over the full range of load (from light load to high output current conditions). The soft start and current control functions are internally optimized. During standby, all circuits are shutdown to reduce current consumption to as low as 1.0 μ A or less. With the built-in UVLO (Under Voltage Lock Out) function, the internal P-channel driver transistor is forced OFF when input voltage becomes 1.4V or lower. Two types of package, SOT-25 (250mW) and USP-6B (100mW), are available.

APPLICATIONS

Mobile phones (PDC, GSM, CDMA, IMT2000 etc.)
 Bluetooth equipment
 PDAs, Portable communication modem
 Portable games
 Cameras, Digital cameras
 Cordless phones
 Notebook computers

FEATURES

P-Ch Driver Tr. Built-In	: ON resistance 0.6
N-Ch Driver Tr. built-in	: ON resistance 0.7
Input Voltage Range	: 2.0V~6.0V (A~D series) 4.5V~5.5V (E~H series)
Output Voltage Range	: 0.9V~4.0V (A~D series) 3.0V~4.0V (E~H series) (0.05V increments)
Low Power Consumption	: 15 μ A (TYP.) ($V_{IN}=3.6V, V_{OUT}=1.8V$)
Control Method	: Fixed PWM (XC9225) PWM/PFM Automatic (XC9226) PWM/PFM Manual (XC9227)
High Efficiency	: 92% (TYP.) ($V_{IN}=3.0V, V_{OUT}=1.8V, I_{OUT}=100mA$)*
Output Current	: 500mA *(A~D series) 600mA *(E~H series)
Oscillation Frequency	: 600kHz, 1.2MHz ($\pm 15\%$)
Low Output Ripple	: 10mV
Maximum Duty Ratio	: 100%
Soft-Start Circuit Built-In	
Current Limiter Circuit Built-In (Constant Current & Latching)	
Low ESR Ceramic Capacitor Compatible	
Packages	: SOT-25 (SOT-23-5), USP-6B

* Performance depends on external components and wiring on the PCB

TYPICAL APPLICATION CIRCUIT

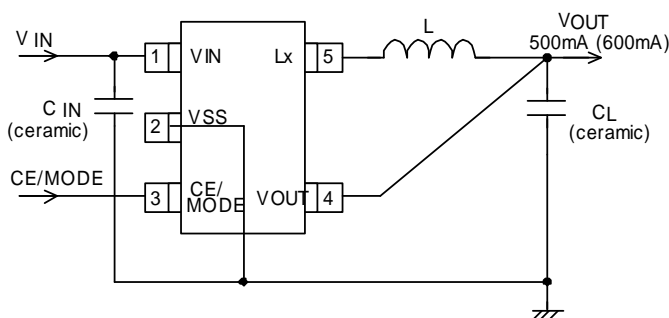

TYPICAL PERFORMANCE CHARACTERISTICS

Efficiency vs. Output Current

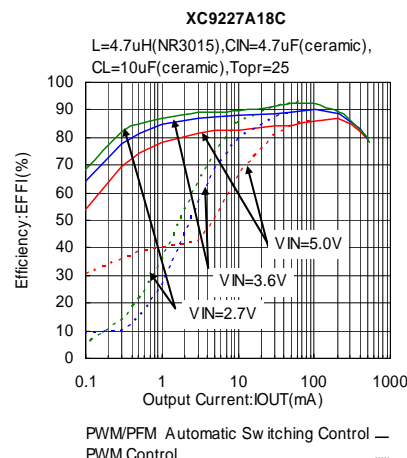

PIN CONFIGURATION

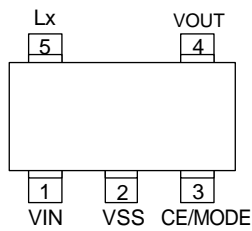

SOT-25 (TOP VIEW)

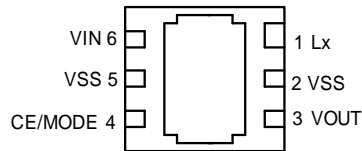

USP-6B
(BOTTOM VIEW)

- * Please short the Vss (No. 2 and 5) pin.
- * The dissipation pad for the USP-6B package should be solder-plated in recommended mount pattern and metal masking so as to enhance mounting strength and heat release. If the pad needs to be connected to other pins, it should be connected to the VSS (No. 5) pin.

PIN ASSIGNMENT

PIN NUMBER		PIN NAME	FUNCTION
SOT-25	USP-6B		
1	6	VIN	Power Input
2	2, 5	Vss	Ground
3	4	CE / MODE	Chip Enable Mode Switch
4	3	VOUT	Output Voltage Sense
5	1	Lx	Switching Output

FUNCTIONS

CE/MODE VOLTAGE LEVEL	OPERATION		
	XC9225A SERIES	XC9226A SERIES	XC9227A SERIES
H Level *1	Synchronous PWM Fixed Control	Synchronous PWM/PFM Automatic Switching Control	Synchronous PWM/PFM Automatic Switching Control
M Level *2			Synchronous PWM Fixed Control
L Level *3	Stand-by	Stand-by	Stand-by

*CE/MODE pin voltage level range

*1. H level: $V_{IN}-0.3V$ H level V_{IN}

*2. M level: 0.65V M level V_{IN} $V_{IN}-1.0V$

*3. L level : 0V L level 0.25V

PRODUCT CLASSIFICATION

Ordering Information

<u>XC9225</u>	PWM fixed control
<u>XC9226</u>	PWM / PFM automatic switching control
<u>XC9227</u>	PWM fixed control⇔PWM / PFM automatic switching, manual switching

DESIGNATOR	DESCRIPTION	SYMBOL	DESCRIPTION
	Transistor built-in, Output voltage internally set (V _{OUT} product), Soft-start internally set Current limit: 700mA	A	CE input logic High Active, CE pin open (Standard)
		B	CE input logic Low Active, CE pin open (Semi-custom)
		C	CE input logic High Active, Pull-down resistor built-in (Semi-custom)
		D	CE input logic Low Active, Pull-up resistor built-in (Semi-custom)
	Transistor built-in, Output voltage internally set (V _{OUT} product), Soft-start internally set Current limit: 900mA	E	CE input logic High Active, CE pin open (Standard)
		F	CE input logic Low Active, CE pin open (Semi-custom)
		G	CE input logic High Active, Pull-down resistor built-in (Semi-custom)
		H	CE input logic Low Active, Pull-up resistor built-in (Semi-custom)
	Output Voltage	0~4	Integer number of output voltage e.g. V _{OUT} =2.8V =2 *3.0V~4.0V output only for E~H series
	Output Voltage	0~9, A~M	Decimal number of output voltage 100mV increment: 00=0, 10=1, 20=2, 30=3, 40=4, 50=5, 60=6, 70=7, 80=8, 90=9 e.g. V _{OUT} =2.8V =2, =8 50mV increment: 05=A, 15=B, 25=C, 35=D, 45=E, 55=F, 65=H, 75=K, 85=L, 95=M e.g. V _{OUT} =2.85V =2, =L *3.0V~4.0V output only for E~H series
	Oscillation Frequency	6	600kHz
		C	1.2MHz
	Package	M	SOT-25 (SOT-23-5)
		D	USP-6B
	Device Orientation	R	Embossed tape, standard feed
		L	Embossed tape, reverse feed

*Output voltage range of the E, F, G, H series is 3.0~4.0V only.

BLOCK DIAGRAM

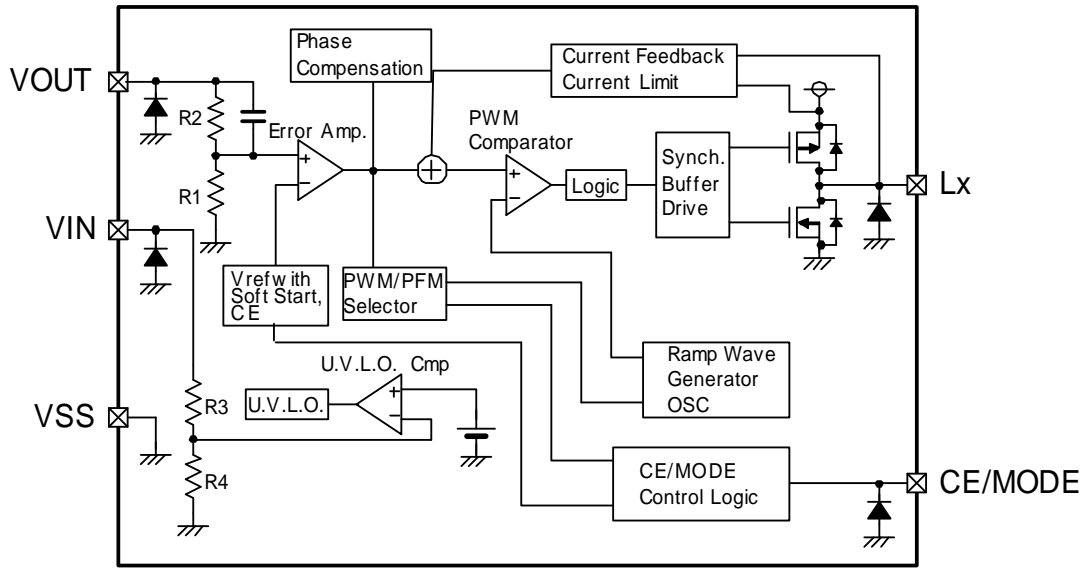

NOTE: The signal from CE/MODE Control Logic to PWM/PFM Selector is being fixed to "L" level inside, and XC9225 series chooses only PWM control.
 The signal from CE/MODE Control Logic to PWM/PFM Selector is being fixed to "H" level inside, and XC9226 series chooses only PWM/PFM automatic switching control.

ABSOLUTE MAXIMUM RATINGS

Ta=25

PARAMETER	SYMBOL	RATINGS	UNITS
VIN Pin Voltage	VIN	- 0.3 ~ 6.5	V
Lx Pin Voltage	VLx	- 0.3 ~ VIN + 0.3	V
VOUT Pin Voltage	VOUT	- 0.3 ~ 6.5	V
CE / MODE Pin Voltage	VCE	- 0.3 ~ VIN + 0.3	V
Lx Pin Current	ILx	± 1000	mA
Power Dissipation	SOT-25	Pd	250
	USP-6B		100
Operating Temperature Range	Topr	- 40 ~ + 85	
Storage Temperature Range	Tstg	- 55 ~ +125	

ELECTRICAL CHARACTERISTICS

XC9225A18Cxx, XC9226A18Cxx, XC9227A18Cxx

V_{OUT}=1.8V, f_{OSC}=1.2MHz, T_a=25

PARAMETER	SYMBOL	CONDITIONS	MIN.	TYP.	MAX.	UNIT	CIRCUIT
Output Voltage	V _{OUT}	When connected to external components, CE=V _{IN} , I _{OUT} =30mA	1.764	1.800	1.836	V	
Operating Voltage Range	V _{IN}	-	2.0	-	6.0	V	
Maximum Output Current	I _{OUTMAX}	V _{IN} <T-1>V, When connected to external components (A series) (*10)	500	-	-	mA	
UVLO Voltage	V _{UVLO}	CE=V _{IN} , V _{OUT} =0V, Voltage which Lx pin voltage holding "L" level (*1), (*12)	1.00	1.40	1.78	V	
Supply Current	I _{DD}	V _{IN} =CE=3.6V, V _{OUT} =set voltage x 1.1V	-	15	35	μA	
Stand-by Current	I _{stb}	V _{IN} =3.6V, CE=0V, V _{OUT} =set voltage x 1.1V	-	0	1.0	μA	
Oscillation Frequency	f _{OSC}	When connected to external components, I _{OUT} =100mA	1020	1200	1380	kHz	
PFM Switch Current	I _{PFM}	When connected to external components, CE=V _{IN} , I _{OUT} =0.1mA	120	160	200	mA	
Maximum IPFM Limit	MAXIPFM	V _{IN} =V _{OUT} +1.0V, CE=V _{IN} , I _{OUT} =0.1mA	35	44	50	%	
Maximum Duty Ratio	MAXDTY	CE=V _{IN} , V _{OUT} =0V	100	-	-	%	
Minimum Duty Ratio	MINDTY	CE=V _{OUT} =V _{IN}	-	-	0	%	
Efficiency (*2)	EFFI	When connected to external components, CE=V _{IN} =3.0V, I _{OUT} =100mA	-	90	-	%	
Lx SW "H" ON Resistance	R _{LxH}	CE=0.5V _{IN} , V _{OUT} =0V, I _{Lx} =100mA (*3)	-	0.6	1.2		
Lx SW "L" ON Resistance	R _{LxL}	CE=0.5V _{IN} , I _{Lx} =100mA (*4)	-	0.7	1.4		
Lx SW "H" Leak Current	I _{LeakH}	V _{IN} =V _{OUT} =5.0V, CE=0V, Lx=0V (*5)	-	0.01	1.0	μA	
Lx SW "L" Leak Current	I _{LeakL}	V _{IN} =V _{OUT} =5.0V, CE=0V, Lx=5.0V	-	0.01	1.0	μA	
Current Limit (*11)	I _{LIM}	V _{IN} =CE=5.0V, V _{OUT} =0V (A series)	600	700	-	mA	
Output Voltage Temperature Characteristics	$\frac{V_{OUT}}{V_{OUT} \cdot T_{opr}}$	I _{OUT} =30mA -40 T _{opr} 85	-	± 100	-	ppm/	
CE "H" Voltage	V _{CEH}	V _{OUT} =0V, When CE voltage is applied Lx determine "H"(*12)	0.65	-	V _{IN}	V	
CE "L" Voltage	V _{CEL}	V _{OUT} =0V, When CE voltage is applied Lx determine "L" (*12)	V _{SS}	-	0.25	V	
PWM "H" Level Voltage	V _{PWMH}	When connected to external components, I _{OUT} =1mA (*6)	-	-	V _{IN} -1.0	V	
PWM "L" Level Voltage	V _{PWML}	When connected to external components, I _{OUT} =1mA (*6)	V _{IN} -0.3	-	-	V	
CE "H" Current	I _{CEH}	V _{IN} =CE=5.5V, V _{OUT} =0V	- 0.1	-	0.1	μA	
CE "L" Current	I _{CEL}	V _{IN} =5.5V, CE=0V, V _{OUT} =0V	- 0.1	-	0.1	μA	
Soft-Start Time	t _{SS}	When connected to external components, CE=0V V _{IN} , I _{OUT} =1mA	0.5	1.0	3.0	ms	
Latch Time	t _{lat}	When connected to external components, V _{IN} =CE=5.0V, Short V _{OUT} by 1 resistance (*7)	1	-	20	ms	

Test conditions: Unless otherwise stated, V_{IN}=3.6V
External components L: 4.7uH (CDRH4D18C), CIN: 4.7uF (ceramic) CL: 10uF (ceramic)

<T-1> refers to the below values.

Setting voltage 1.5V>V_{OUT}≥0.9V T-1=2.4V
Setting voltage 1.8V>V_{OUT}≥1.5V T-1=3.0V
Setting voltage 4.0V≥V_{OUT}≥1.8V T-1=V_{OUT}+1.2V

NOTE:

- *1: Including hysteresis operating voltage range.
- *2: $EFFI = \{ (\text{output voltage} \times \text{output current}) / (\text{input voltage} \times \text{input current}) \} \times 100$
- *3: On resistance () = Lx pin measurement voltage / 100mA
- *4: R&D value
- *5: When temperature is high, a current of approximately 20 μA (maximum) may leak.
- *6: The CE/MODE pin of the XC9227A series works also as an external PWM control and PWM/PFM control switching pin. When the IC is in the operation, control is switched to the automatic PWM/PFM switching mode when the CE/MODE pin voltage is equal to or greater than V_{IN} minus 0.3V, and to the PWM mode when the CE/MODE pin voltage is equal to or lower than V_{IN} minus 1.0V and equal to or greater than V_{CEH}.
- *7: Time until it short-circuits V_{OUT} with GND through 1 of resistance from a state of operation and is set to V_{OUT}=0V from current limit pulse generating.
- *8: There is no PFM switch current for XC9225 series. The PFM switch current is only for XC9226/9227 series.
- *9: There is no PWM "H" Level Voltage or PWM "L" Level Voltage for XC9225/9226 series. The characteristics are only for XC9227 series.
- *10: When the difference between the input and the output is small, some cycles may be skipped completely before current maximizes. If current is further pulled from this state, output voltage will decrease because of P-ch driver ON resistance.
- *11: Current limit denotes the level of detection at peak of coil current..
- *12: "H"=V_{IN}-V_{IN}-1.2V, "L"=+0.1V~-0.1V

ELECTRICAL CHARACTERISTICS (Continued)

XC9225A (E) 33Cxx, XC9226A (E) 33Cxx, XC9227A (E) 33Cxx

V_{OUT}=3.3V, f_{OSC}=1.2MHz, T_a=25

PARAMETER	SYMBOL	CONDITIONS	MIN.	TYP.	MAX.	UNIT	CIRCUIT
Output Voltage	V _{OUT}	When connected to external components, CE=V _{IN} , I _{OUT} =30mA	3.234	3.300	3.366	V	
Operating Voltage Range	V _{IN}	A series	2.0	-	6.0	V	
		E series	4.5	-	5.5	V	
Maximum Output Current	I _{OUTMAX}	V _{IN} <T-1>V, when connected to external components (A series) (*10)	500	-	-	mA	
		V _{IN} =V _{OUT} +1.5V when connected to external components (E series) (*10)	600			mA	
U.V.L.O. Voltage	V _{UVLO}	CE=V _{IN} , V _{OUT} =0V, Voltage which Lx pin voltage holding "L" level (*1), (*12)	1.00	1.40	1.78	V	
Supply Current	I _{DD}	V _{IN} =CE=5.0V, V _{OUT} =set voltage x 1.1V	-	15	35	μA	
Stand-by Current	I _{stb}	V _{IN} =5.0V, CE=0V, V _{OUT} =set voltage x 1.1V	-	0	1.0	μA	
Oscillation Frequency	f _{OSC}	When connected to external components, I _{OUT} =100mA	1020	1200	1380	kHz	
PFM Switch Current	I _{PFM}	When connected to external components, CE=V _{IN} , I _{OUT} =1mA	120	160	200	mA	
Maximum IPFM Current	MAXIPFM	V _{IN} =V _{OUT} +1.0V, CE=V _{IN} , I _{OUT} =0.1mA	35	44	50	%	
Maximum Duty Ratio	MAXDTY	CE=V _{IN} , V _{OUT} =0V	100	-	-	%	
Minimum Duty Ratio	MINDTY	CE=V _{OUT} =V _{IN}	-	-	0	%	
Efficiency (*2)	EFFI	When connected to external components, CE=V _{IN} =4.5V, I _{OUT} =100mA	-	92	-	%	
Lx SW "H" ON Resistance	R _{LxH}	CE=0.5V _{IN} , V _{OUT} =0V, I _{Lx} =100mA (*3)	-	0.5	1.0		
Lx SW "L" ON Resistance	R _{LxL}	CE=0.5V _{IN} , I _{Lx} =100mA (*4)	-	0.6	1.2		
Lx SW "H" Leak Current	I _{LeakH}	V _{IN} =V _{OUT} =5.0V, CE=0V, Lx=0V (*5)	-	0.01	1.0	μA	
Lx SW "L" Leak Current	I _{LeakL}	V _{IN} =V _{OUT} =5.0V, CE=0V, Lx=5.0V	-	0.01	1.0	μA	
Current Limit (*11)	I _{LIM}	V _{IN} =CE=5.0V, V _{OUT} =0V (A series)	600	700		mA	
		V _{IN} =CE=5.0V, V _{OUT} =0V (E series)	800	900	-	mA	
Output Voltage Temperature Characteristics	$\frac{V_{OUT}}{V_{OUT} \cdot T_{opr}}$	I _{OUT} =30mA -40 T _{opr} 85	-	± 100	-	ppm/	
CE "H" Voltage	V _{CEH}	V _{OUT} =0V, When CE voltage is applied Lx determine "H" (*12)	0.65	-	V _{IN}	V	
CE "L" Voltage	V _{CEL}	V _{OUT} =0V, When CE voltage is applied Lx determine "L" (*12)	V _{SS}	-	0.25	V	
PWM "H" Level Voltage	V _{PWMH}	When connected to external components, I _{OUT} =1mA (*6)	-	-	V _{IN} -1.0	V	
PWM "L" Level Voltage	V _{PWML}	When connected to external components, I _{OUT} =1mA (*6)	V _{IN} -0.3	-	-	V	
CE "H" Current	I _{CEH}	V _{IN} =CE=5.5V, V _{OUT} =0V	- 0.1	-	0.1	μA	
CE "L" Current	I _{CEL}	V _{IN} =5.5V, CE=0V, V _{OUT} =0V	- 0.1	-	0.1	μA	
Soft-Start Time	t _{SS}	When connected to external components, CE=0V V _{IN} , I _{OUT} =1mA	0.5	1.0	3.0	ms	
Latch Time	t _{lat}	When connected to external components, V _{IN} =CE=5.0V, Short V _{OUT} by 1 resistance (*7)	1	-	20	ms	

Test conditions: Unless otherwise stated, V_{IN}=5.0V
External components L: 4.7μH (CDRH4D18C), CIN: 4.7μF (ceramic) CL: 10μF (ceramic)

<T-1> refers to the below values.
Setting voltage 1.5V>V_{OUT}≥0.9V T-1=2.4V
Setting voltage 1.8V>V_{OUT}≥1.5V T-1=3.0V
Setting voltage 4.0V≥V_{OUT}≥1.8V T-1=V_{OUT}+1.2V

NOTE:

- *1: Including hysteresis operating voltage range.
- *2: $EFFI = \left\{ \left(\text{output voltage} \times \text{output current} \right) / \left(\text{input voltage} \times \text{input current} \right) \right\} \times 100$
- *3: On resistance () = Lx pin measurement voltage / 100mA
- *4: R&D value
- *5: When temperature is high, a current of approximately 20 μA (maximum) may leak.
- *6: The CE/MODE pin of the XC9227A series works also as an external PWM control and PWM/PFM control switching pin. When the IC is in the operation, control is switched to the automatic PWM/PFM switching mode when the CE/MODE pin voltage is equal to or greater than V_{IN} minus 0.3V, and to the PWM mode when the CE/MODE pin voltage is equal to or lower than V_{IN} minus 1.0V and equal to or greater than V_{CEH}.
- *7: Time until it short-circuits V_{OUT} with GND through 1 of resistance from a state of operation and is set to V_{OUT}=0V from current limit pulse generating.
- *8: There is no PFM switch current for XC9225 series. The PFM switch current is only for XC9226/9227 series.
- *9: There is no PWM "H" Level Voltage or PWM "L" Level Voltage for XC9225/9226 series. The characteristics are only for XC9227 series.
- *10: When the difference between the input and the output is small, some cycles may be skipped completely before current maximizes. If current is further pulled from this state, output voltage will decrease because of P-ch driver ON resistance.
- *11: Current limit denotes the level of detection at peak of coil current.
- *12: "H"=V_{IN}-V_{IN}-1.2V, "L"=+0.1V~-0.1V

TYPICAL APPLICATION CIRCUIT

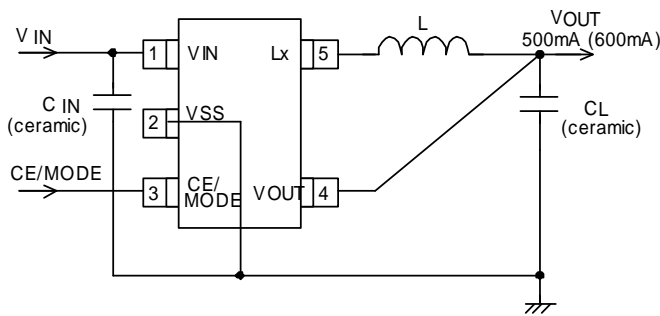

FOSC=1.2MHz	
L : 4.7 μ H	(NR3015, TAIYO YUDEN)
: 4.7 μ H	(VLF4012A, TDK)
: 4.7 μ H	(CDRH4D18C, SUMIDA)
CIN : 4.7 μ F	(Ceramic)
CL : 10 μ F	(Ceramic)
FOSC=600kHz	
L : 10 μ H	(NR4018, TAIYO YUDEN)
: 10 μ H	(VLF4012A, TDK)
: 10 μ H	(CDRH4, SUMIDA)
CIN : 4.7 μ F	(Ceramic)
CL : 10 μ F	(Ceramic)

OPERATIONAL EXPLANATION

The XC9225/9226/9227 series consists of a reference voltage source, ramp wave circuit, error amplifier, PWM comparator, phase compensation circuit, output voltage adjustment resistors, P-channel MOSFET driver transistor, N-channel MOSFET switching transistor for the synchronous switch, current limiter circuit, U.V.L.O. circuit and others. (See the block diagram above.) The series ICs compare, using the error amplifier, the voltage of the internal voltage reference source with the feedback voltage from the VOUT pin through split resistors, R1 and R2. Phase compensation is performed on the resulting error amplifier output, to input a signal to the PWM comparator to determine the turn-on time during PWM operation. The PWM comparator compares, in terms of voltage level, the signal from the error amplifier with the ramp wave from the ramp wave circuit, and delivers the resulting output to the buffer driver circuit to cause the Lx pin to output a switching duty cycle. This process is continuously performed to ensure stable output voltage. The current feedback circuit monitors the P-channel MOS driver transistor current for each switching operation, and modulates the error amplifier output signal to provide multiple feedback signals. This enables a stable feedback loop even when a low ESR capacitor, such as a ceramic capacitor, is used, ensuring stable output voltage.

<Reference Voltage Source>

The reference voltage source provides the reference voltage to ensure stable output voltage of the DC/DC converter.

<Ramp Wave Circuit>

The ramp wave circuit determines switching frequency. The frequency is fixed internally and can be selected from 600kHz and 1.2MHz. Clock pulses generated in this circuit are used to produce ramp waveforms needed for PWM operation, and to synchronize all the internal circuits.

<Error Amplifier>

The error amplifier is designed to monitor output voltage. The amplifier compares the reference voltage with the feedback voltage divided by the internal split resistors, R1 and R2. When a voltage lower than the reference voltage is fed back, the output voltage of the error amplifier increases. The gain and frequency characteristics of the error amplifier output are fixed internally to deliver an optimized signal to the mixer.

<Current Limit>

The current limiter circuit of the XC9225 / 9226 / 9227 series monitors the current flowing through the P-channel MOS driver transistor connected to the Lx pin, and features a combination of the constant-current type current limit mode and the operation suspension mode.

When the driver current is greater than a specific level, the constant-current type current limit function operates to turn off the pulses from the Lx pin at any given timing.

When the driver transistor is turned off, the limiter circuit is then released from the current limit detection state.

At the next pulse, the driver transistor is turned on. However, the transistor is immediately turned off in the case of an over current state.

When the over current state is eliminated, the IC resumes its normal operation.

The IC waits for the over current state to end by repeating the steps through . If an over current state continues for a few msec and the above three steps are repeatedly performed, the IC performs the function of latching the OFF state of the driver transistor, and goes into operation suspension mode. Once the IC is in suspension mode, operations can be resumed by either turning the IC off via the CE/MODE pin, or by restoring power to the VIN pin. The suspension mode does not mean a complete shutdown, but a state in which pulse output is suspended; therefore, the internal circuitry remains in operation. The constant-current type current limit of the XC9225 / 9226 / 9227 series can be set at 700mA (A~D series) and 900mA (E~H series) at typical. Besides, care must be taken when laying out the PC Board, in order to prevent misoperation of the current limit mode. Depending on the state of the PC Board, latch time may become longer and latch operation may not work. In order to avoid the effect of noise, the board should be laid out so that capacitors are placed as close to the chip as possible.

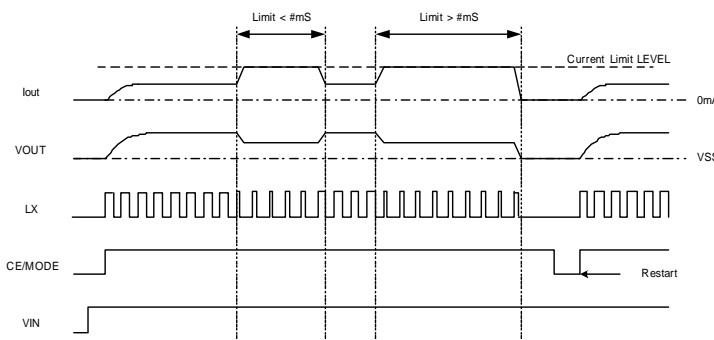

OPERATIONAL EXPLANATION (Continued)

<U.V.L.O. Circuit>

When the VIN pin voltage becomes 1.4V or lower, the P-channel output driver transistor is forced OFF to prevent false pulse output caused by unstable operation of the internal circuitry. When the VIN pin voltage becomes 1.8V or higher, switching operation takes place. By releasing the U.V.L.O. function, the IC performs the soft start function to initiate output startup operation. The soft start function operates even when the VIN pin voltage falls momentarily below the U.V.L.O. operating voltage. The U.V.L.O. circuit does not cause a complete shutdown of the IC, but causes pulse output to be suspended; therefore, the internal circuitry remains in operation.

<PFM Switch Current>

In PFM control operation, until coil current reaches to a specified level (IPFM), the IC keeps the P-ch MOSFET on. In this case, time that the P-ch MOSFET is kept on (TON) can be given by the following formula.

$$T_{ON} = L \times I_{PFM} / (V_{IN} - V_{OUT}) \quad I_{PFM}$$

<Maximum IPFM Limit>

In PFM control operation, the maximum duty ratio (MAXPFM) is set to 44% (TYP.). Therefore, under the condition that the duty increases (e.g. the condition that the step-down ratio is small), it's possible for P-ch MOSFET to be turned off even when coil current doesn't reach to IPFM.

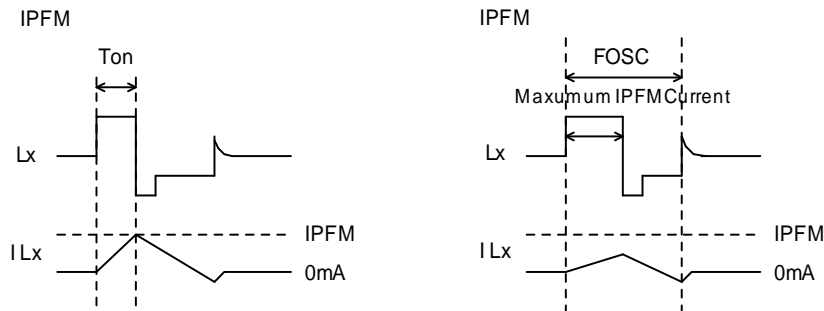

<CE/MODE Pin Function>

The operation of the XC9225A / 9226A / 9227A series will enter into the shut down mode when a low level signal is input to the CE/MODE pin. During the shut down mode, the current consumption of the IC becomes 0μA (TYP.), with a state of high impedance at the Lx pin and VOUT pin. The IC starts its operation by inputting a high level signal to the CE/MODE pin. The input to the CE/MODE pin is a CMOS input and the sink current is 0μA (TYP.).

XC9225A / 9226A series - Examples of how to use CE/MODE pin

(A)

SW_CE	STATUS
ON	Stand-by
OFF	Operation

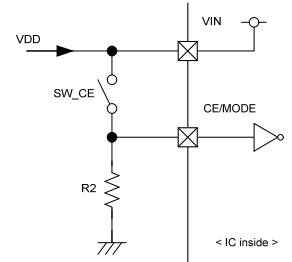
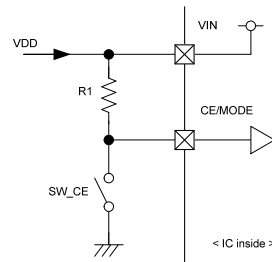

(B)

SW_CE	STATUS
ON	Operation
OFF	Stand-by

XC9227A series - Examples of how to use CE/MODE pin

(A)

SW_CE	SW_PWM/PFM	STATUS
ON	*	PWM/PFM Automatic Switching Control
OFF	ON	PWM Control
OFF	OFF	Stand-by

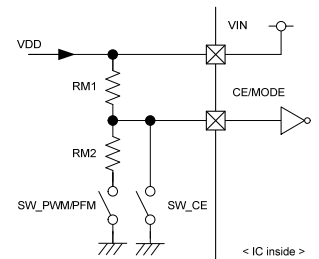
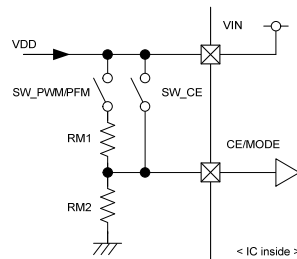

(B)

SW_CE	SW_PWM/PFM	STATUS
ON	*	Stand-by
OFF	ON	PWM Control
OFF	OFF	PWM/PFM Automatic Switching Control

Intermediate voltage can be generated by RM1 and RM2. Please set the value of each R1, R2, RM1, RM2 at around 100k. For switches, CPU open-drain I/O port and transistor can be used.

NOTES ON USE

Application Information

- The XC9225/9226/9227 series is designed for use with ceramic output capacitors. If, however, the potential difference between dropout voltage or output current is too large, a ceramic capacitor may fail to absorb the resulting high switching energy and oscillation could occur on the output. If the input-output potential difference is large, connect an electrolytic capacitor in parallel to compensate for insufficient capacitance.
- Spike noise and ripple voltage arise in a switching regulator as with a DC/DC converter. These are greatly influenced by external component selection, such as the coil inductance, capacitance values, and board layout of external components. Once the design has been completed, verification with actual components should be done.
- Depending on the input-output voltage differential, or load current, some pulses may be skipped, and the ripple voltage may increase.
- When the difference between V_{IN} and V_{OUT} is large in PWM control, very narrow pulses will be outputted, and there is the possibility that some cycles may be skipped completely.
- When the difference between V_{IN} and V_{OUT} is small, and the load current is heavy, very wide pulses will be outputted and there is the possibility that some cycles may be skipped completely: in this case, the Lx pin may not go low at all.
- With the IC, the peak current of the coil is controlled by the current limit circuit. Since the peak current increases when dropout voltage or load current is high, current limit starts operating, and this can lead to instability. When peak current becomes high, please adjust the coil inductance value and fully check the circuit operation. In addition, please calculate the peak current according to the following formula:

$$I_{pk} = (V_{IN} - V_{OUT}) * OnDuty / (2 * L * FOSC) + I_{OUT}$$

L: Coil Inductance Value
 FOSC: Oscillation Frequency
- When the peak current, which exceeds limit current, flows within the specified time, the built-in P-ch driver transistor is turned off. During the time until it detects limit current and before the built-in transistor can be turned off, the current for limit current flows; therefore, care must be taken when selecting the rating for the coil or the schottky diode.
- When V_{IN} is less than 2.4V, limit current may not be reached because voltage falls caused by ON resistance.
- Care must be taken when laying out the PC Board, in order to prevent misoperation of the current limit mode. Depending on the state of the PC Board, latch time may become longer and latch operation may not work. In order to avoid the effect of noise, the board should be laid out so that capacitors are placed as close to the chip as possible.
- Use of the IC at voltages below the recommended voltage range may lead to instability.
- This IC should be used within the stated absolute maximum ratings in order to prevent damage to the device.
- When the IC is used in high temperature, output voltage may increase up to input voltage level at no load because of the leak current of the driver transistor.
- The current limit is set to 700mA (A~D series) and 900mA (E~H series) at typical. However, the current of 700/900mA or more may flow. In case that the current limit functions while the V_{OUT} pin is shorted to the GND pin, when P-ch MOSFET is ON, the potential difference for input voltage will occur at both ends of a coil. For this, the time rate of coil current becomes large. By contrast, when N-ch MOSFET is ON, there is almost no potential difference at both ends of the coil since the V_{OUT} pin is shorted to the GND pin. Consequently, the time rate of coil current becomes quite small. According to the repetition of this operation, and the delay time of the circuit, coil current will be converged on a certain current value, exceeding the amount of current, which is supposed to be limited originally. Even in this case, however, after the overcurrent state continues for several msec, the circuit will be latched. A coil should be used within the stated absolute maximum rating in order to prevent damage to the device.
 Current flows into P-ch MOSFET to reach the current limit (I_{LIM}).
 The current of I_{LIM} or more flows since the delay time of the circuit occurs during from the detection of the current limit to OFF of P-ch MOSFET.
 Because of no potential difference at both ends of the coil, the time rate of coil current becomes quite small.
 Lx oscillates very narrow pulses by the current limit for several msec.
 The circuit is latched, stopping its operation.

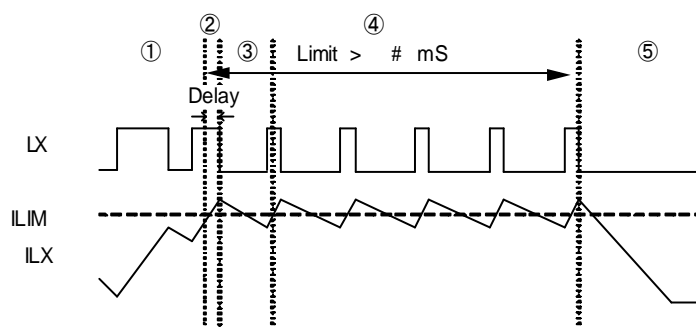

NOTES ON USE (Continued)

Application Information (Continued)

14. In order to stabilize V_{IN} 's voltage level and oscillation frequency, we recommend that a by-pass capacitor (C_{IN}) be connected as close as possible to the V_{IN} & V_{SS} pins.
15. High step-down ratio and very light load may lead an intermittent oscillation.
16. When the inductance value of the coil is large and under the condition of large dropout voltage in continuous mode, operation may become unstable. A coil with an inductance value from $3.3\ \mu\text{H}$ to $6.8\ \mu\text{H}$ should be used. Please verify with actual parts.

ex.) $V_{OUT} = 0.9\text{V}$
 $F_{OSC} = 1.2\text{MHz}$
 $V_{IN} = 6.0\text{V}$
 $I_{OUT} = 70\text{mA}$
 $L : 10\ \mu\text{H}$ (CDRH4D18C)
 $C_{IN} : 4.7\ \mu\text{F}$ (Ceramic)
 $CL : 10\ \mu\text{F}$ (Ceramic)

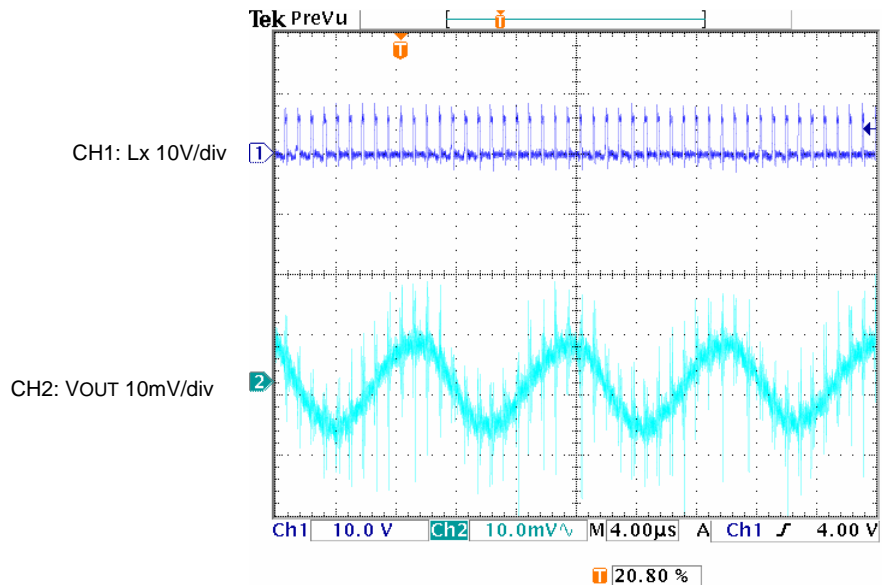

17. Maximum output current of the A series is 500mA and that of the E series is 600mA. Limit current of this IC denotes a peak current, which flows to coils. When using a coil with a small L value, output current (I_{OUT}) may not flow because the peak current increase and the limit current function operates before the output current reaches maximum output current. Accordingly, in the heavy load, the coils' value should be $4.7\ \mu\text{H}$ or more for 1.2MHz and $10\ \mu\text{H}$ or more for 600kHz.

Instructions of pattern layouts

1. In order to stabilize V_{IN} 's voltage level, we recommend that a by-pass capacitor (C_{IN}) be connected as close as possible to the V_{IN} & V_{SS} pins.
2. Please mount each external component as close to the IC as possible.
3. Wire external components as close to the IC as possible and use thick, short connecting traces to reduce the circuit impedance.
4. Make sure that the PCB GND traces are as thick as possible, as variations in ground potential caused by high ground currents at the time of switching may result in instability of the IC.
5. This series' internal driver transistors bring on heat because of the output current and R_{ON} resistance of driver transistors. Please be careful of the heat ability of the PCB when using the XC9225/9226/9227E ~ H series.

NOTES ON USE (Continued)

Reference Pattern Layout

SOT-25

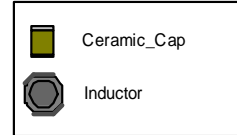
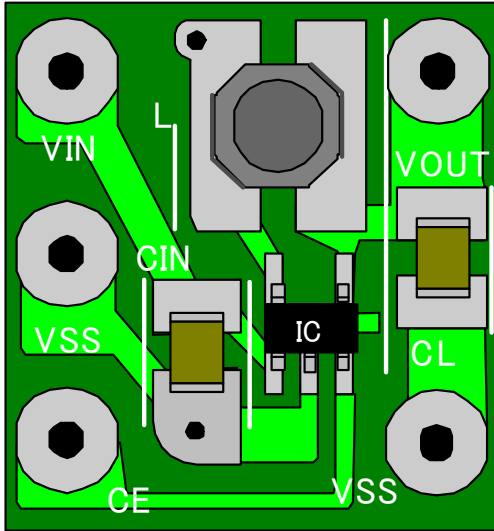

* Please use an electric wire for VIN, VOUT, Vss and CE.

USP-6B

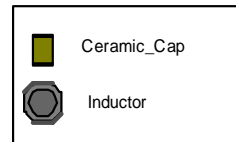
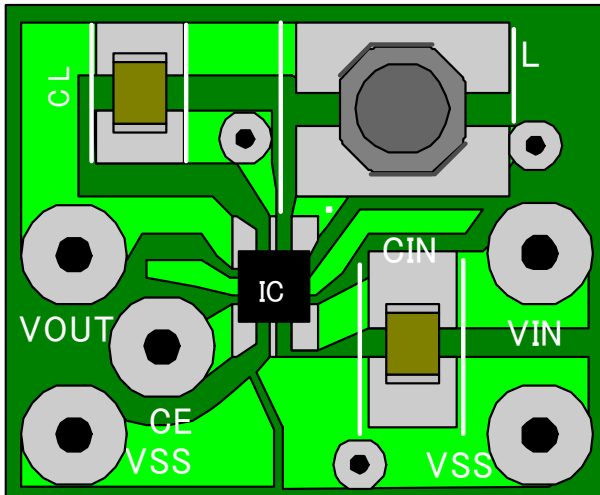

* Please use an electric wire for VIN, VOUT, Vss and CE.

TEST CIRCUITS

Circuit①

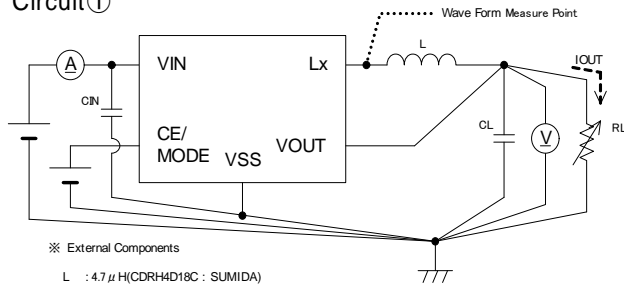

※ External Components
 L : 4.7 μ H(CDRH4D18C : SUMIDA)
 CIN : 4.7 μ F(ceramic)
 CL : 10 μ F(ceramic)

Circuit②

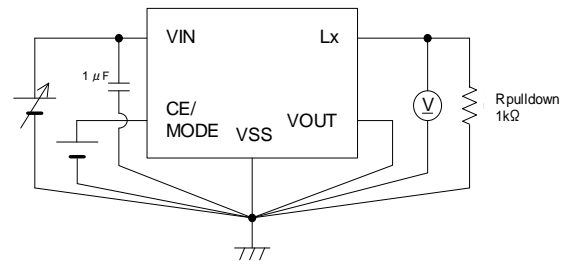

Circuit③

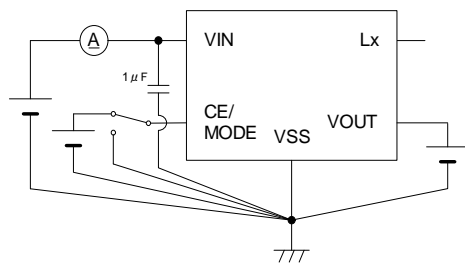

Circuit④

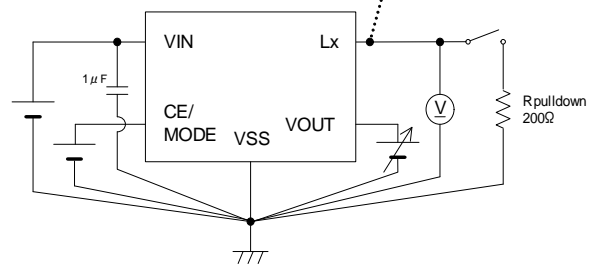

Circuit⑤

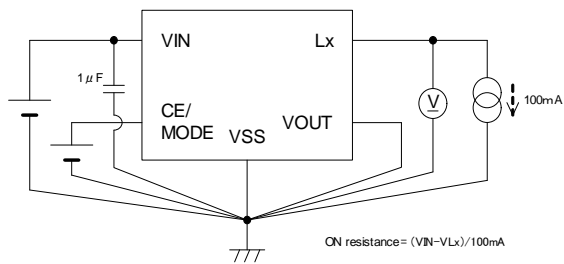

Circuit⑥

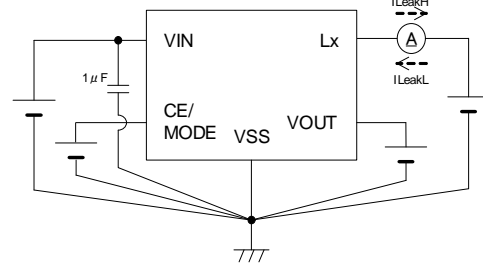

Circuit⑦

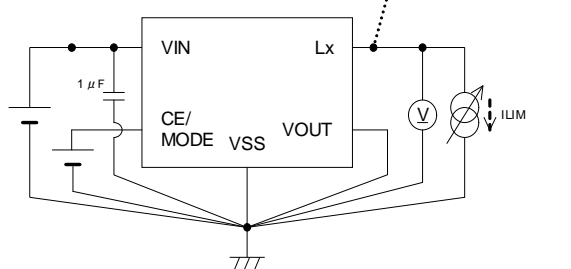

Circuit⑧

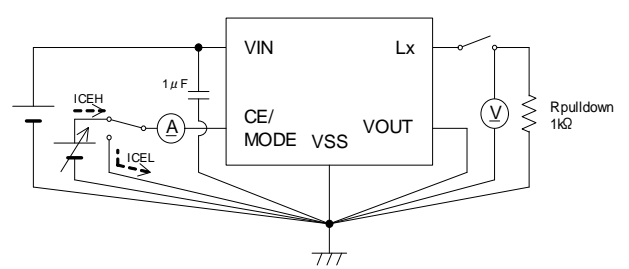

Circuit⑨

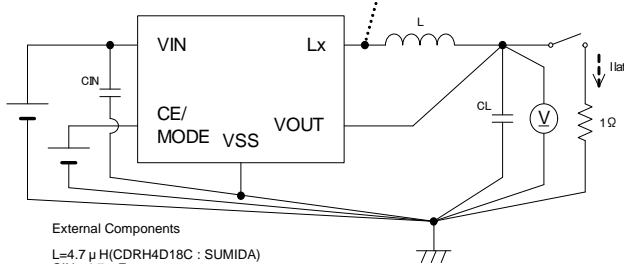

External Components
 L=4.7 μ H(CDRH4D18C : SUMIDA)
 CIN : 4.7 μ F
 CL : 10 μ F

TYPICAL PERFORMANCE CHARACTERISTICS

(1) Efficiency vs. Output Current

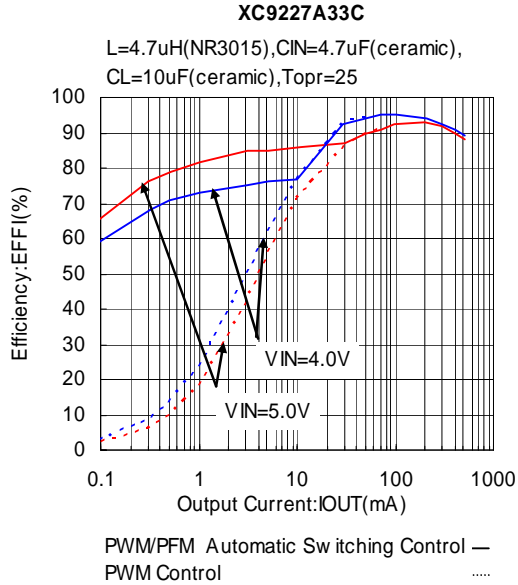
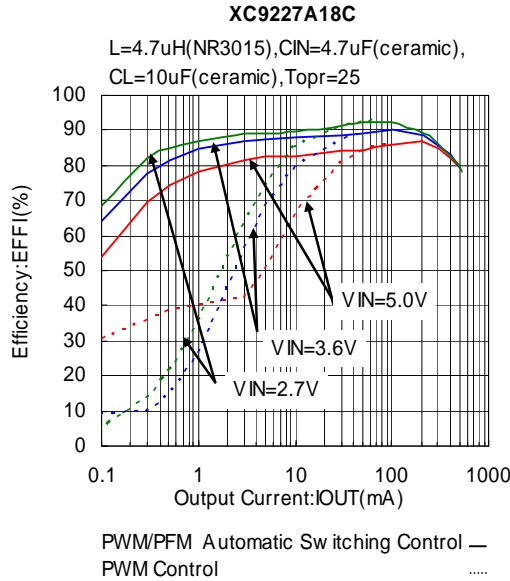

(2) Output Voltage vs. Output Current

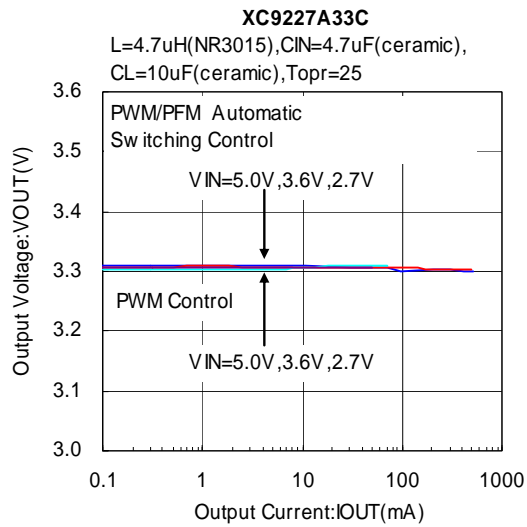
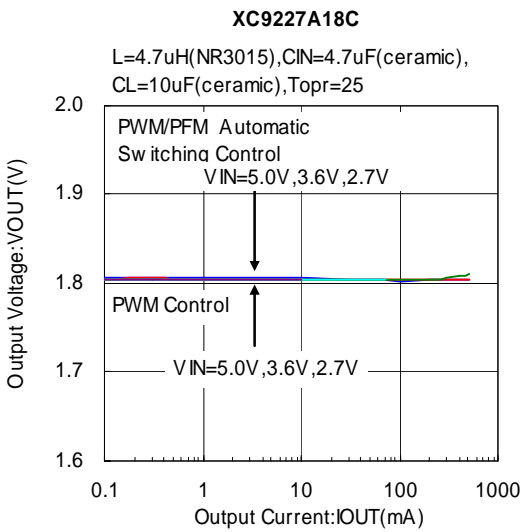

(3) Ripple Voltage vs. Output Current

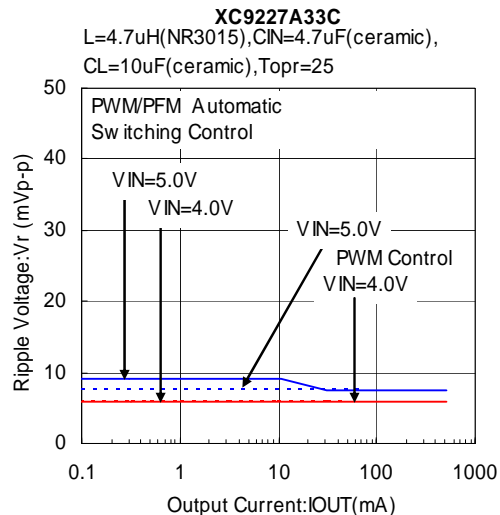
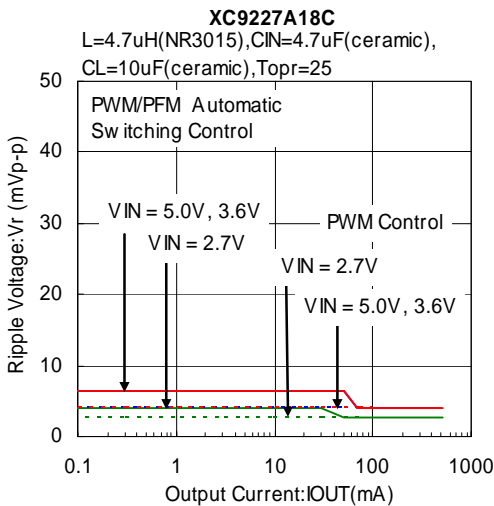

TYPICAL PERFORMANCE CHARACTERISTICS (Continued)

(4) Oscillation Frequency vs. Ambient Temperature

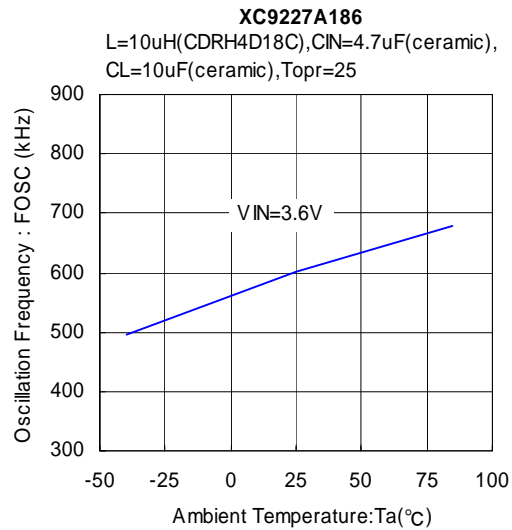
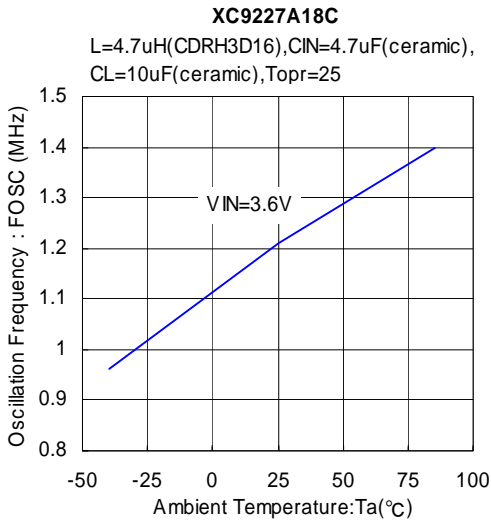

(5) Supply Current vs. Ambient Temperature

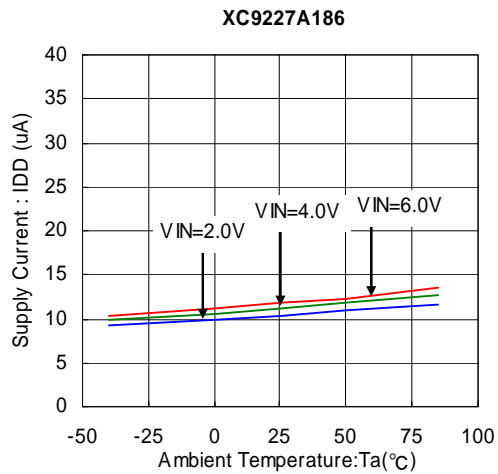
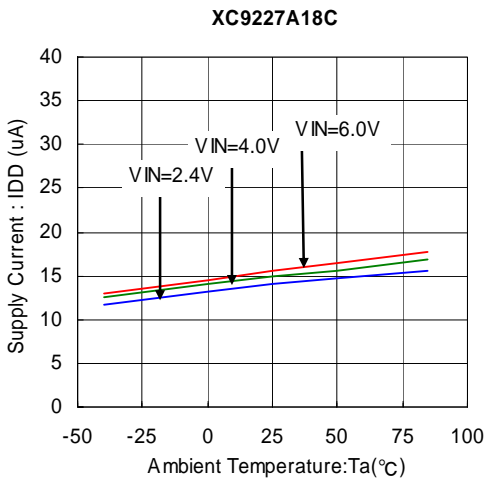

(6) Output Voltage vs. Ambient Temperature

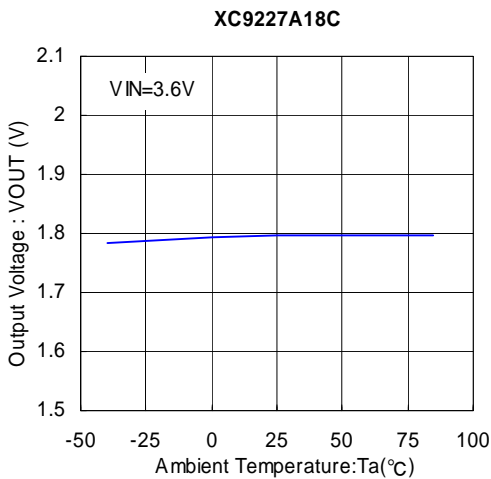

(7) U.V.L.O. Voltage vs. Ambient Temperature

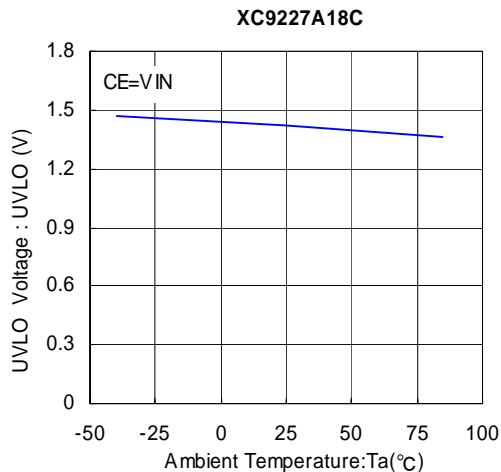

TYPICAL PERFORMANCE CHARACTERISTICS (Continued)

(8) CE "H" / "L" Voltage vs. Ambient Temperature

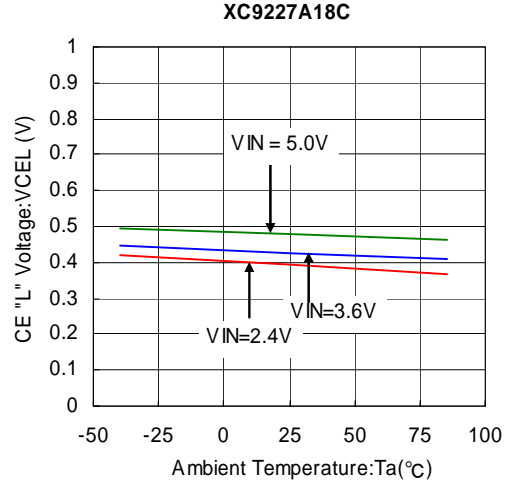
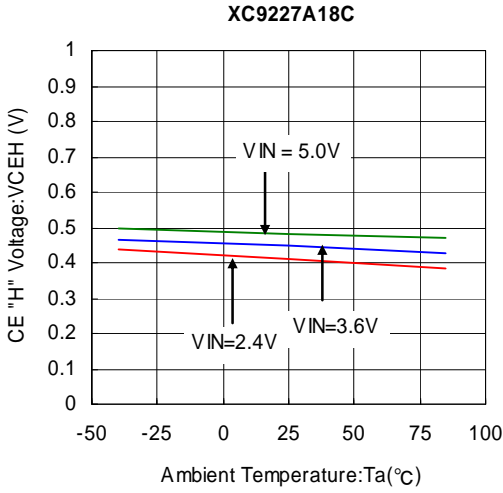

(9) Soft-Start Time vs. Ambient Temperature

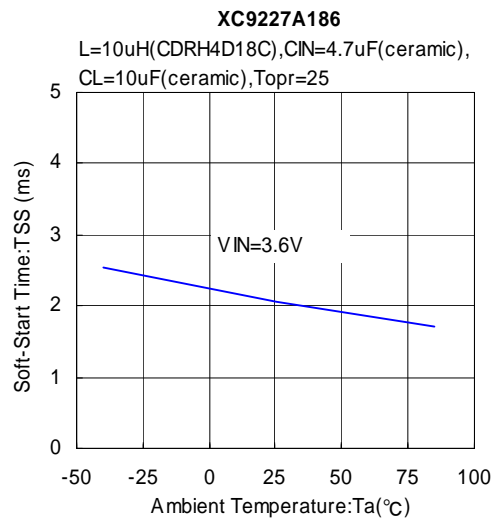
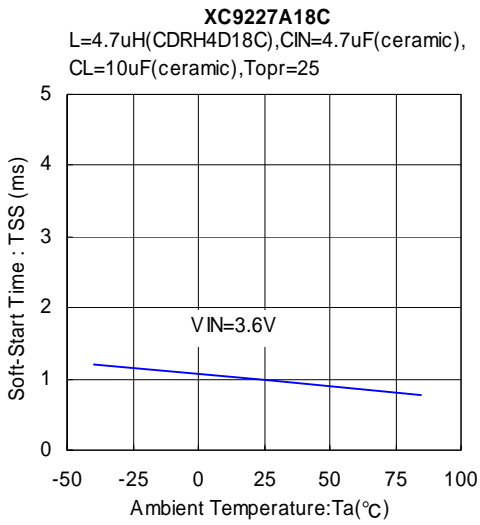

(10) "P-ch / N-ch" Driver ON Resistance vs. Ambient Temperature

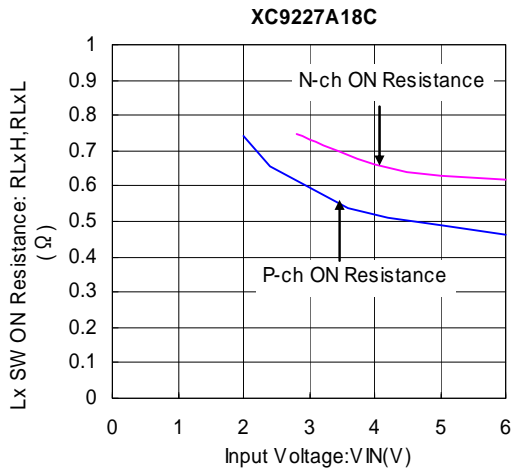

TYPICAL PERFORMANCE CHARACTERISTICS (Continued)

(11) Load Transient Response Time

XC9227A18C

L=4.7 μ H(NR3015), C_{IN}=4.7 μ F(ceramic), C_L=10 μ F(ceramic), Topr=25
V_{IN}=3.6V, CE=V_{IN} (PWM/PFM Automatic Switching Control)

IOUT=1m A 100m A

Saved: 31 MAY 2005 15:36:33

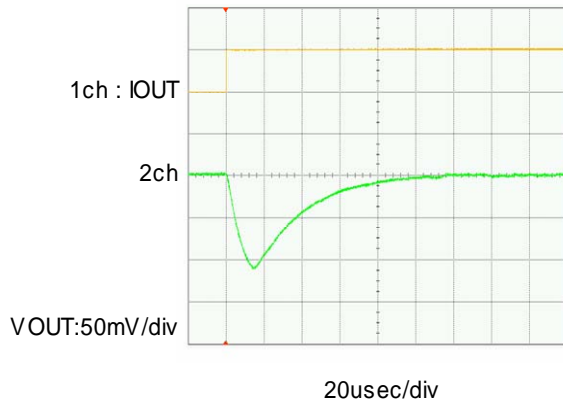

IOUT=1m A 300m A

Saved: 31 MAY 2005 16:41:37

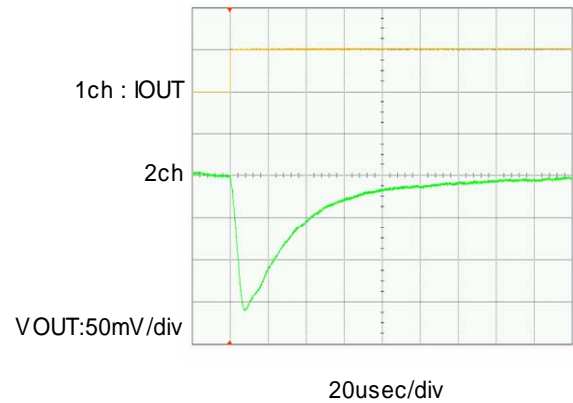

IOUT=100m A 1m A

Saved: 31 MAY 2005 15:39:31

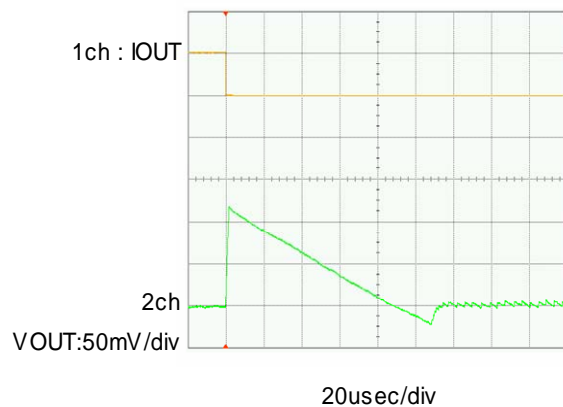

IOUT=300m A 1m A

Saved: 31 MAY 2005 16:35:36

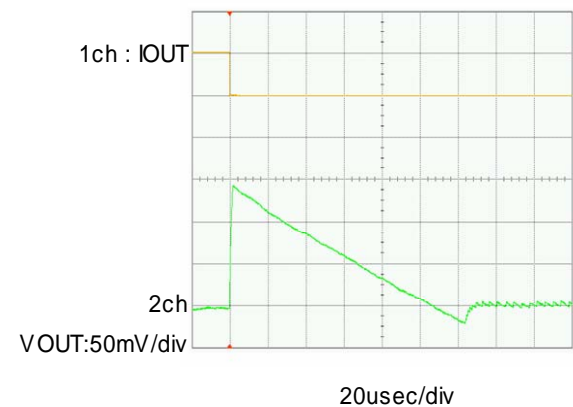

TYPICAL PERFORMANCE CHARACTERISTICS (Continued)

(12) Load Transient Response Time

XC9227A18C

L=4.7 μ H(NR3015), C_{IN}=4.7 μ F(ceramic), CL=10 μ F(ceramic), Topr=25

V_{IN}=3.6V, CE=V_{IN} (PWM Control)

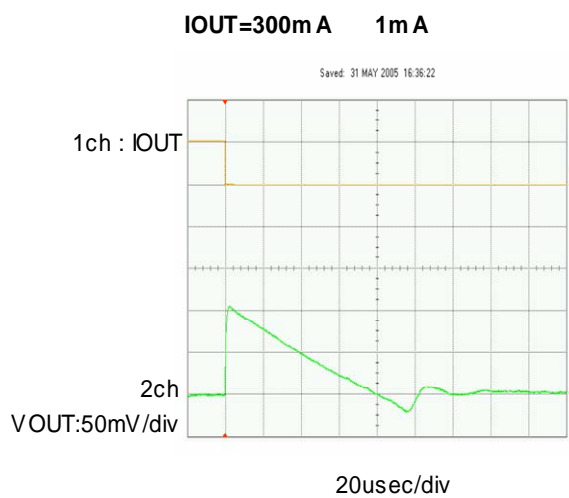
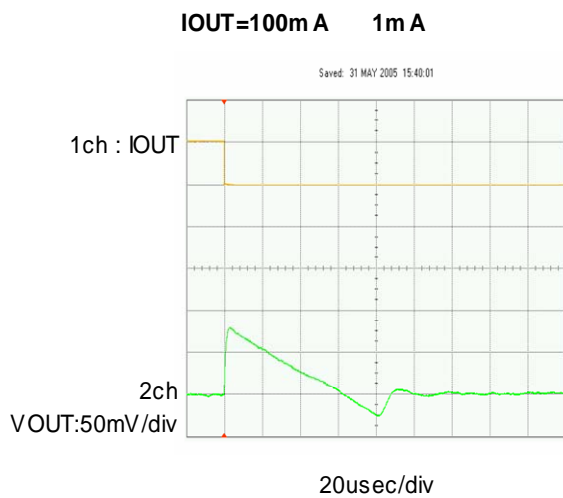
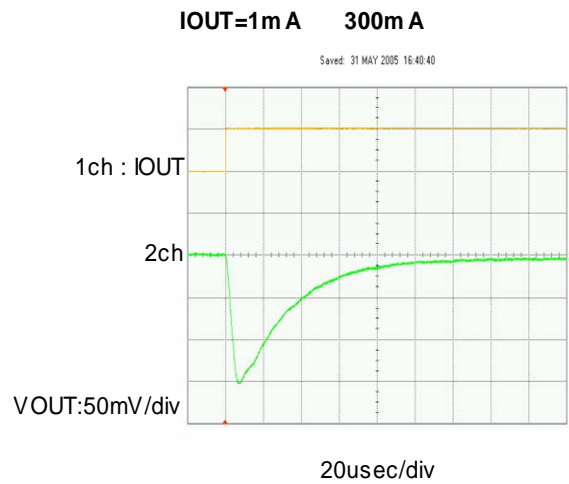
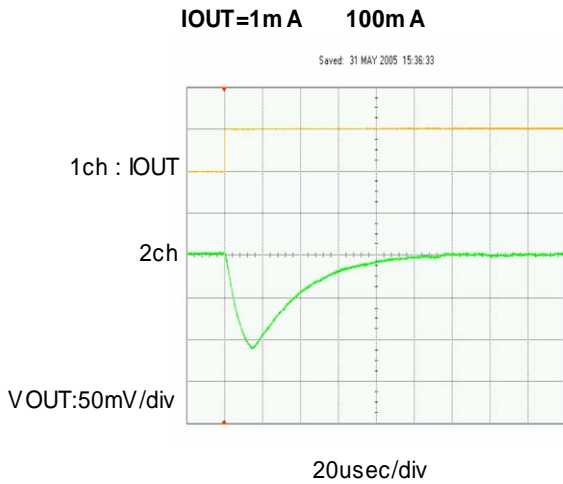

PACKAGING INFORMATION

SOT-25 (SOT-23-5)

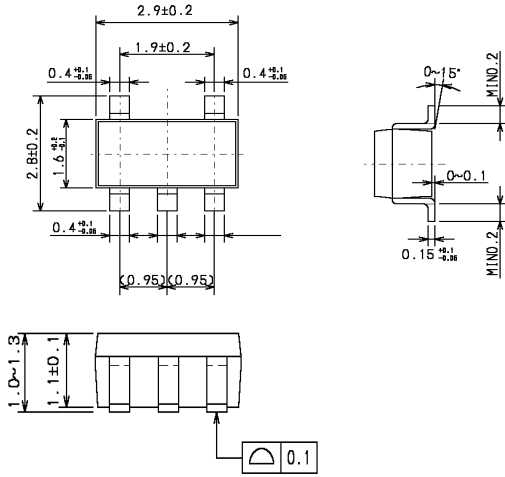

USP-6B

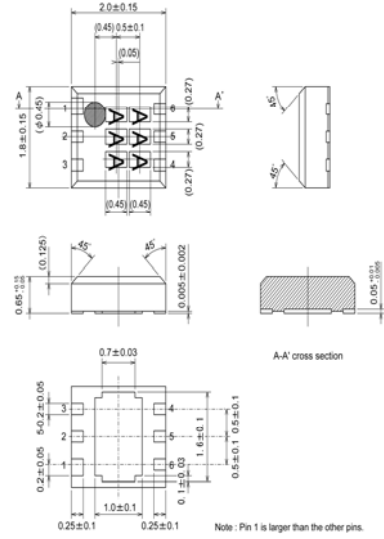

USP-6B Reference Pattern Layout

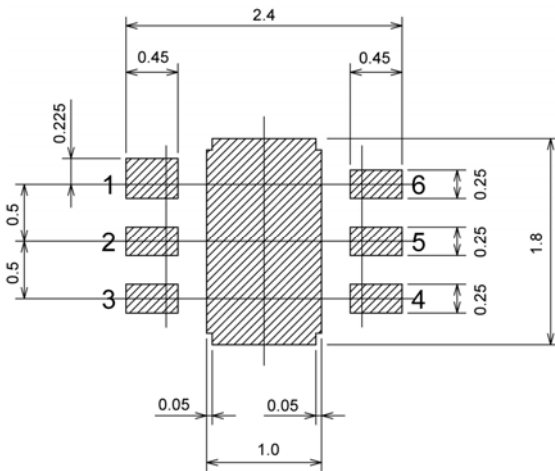

USP-6B Reference Metal Mask Design

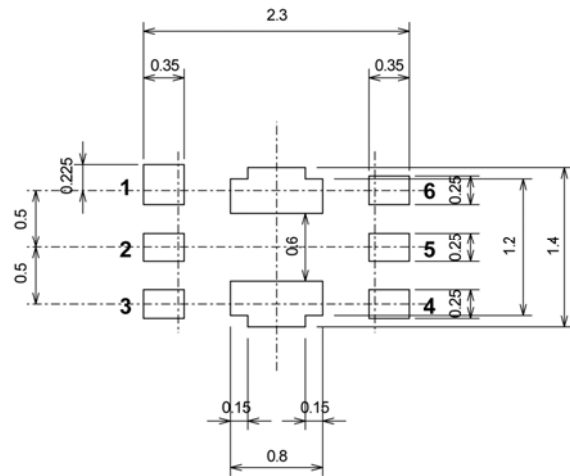

MARKING RULE

SOT-25

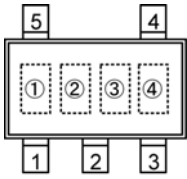

SOT-25 (TOP VIEW)

Represents product series

MARK			PRODUCT SERIES
XC9225	XC9226	XC9227	
T	U	V	A
			B
			C
\overline{T}	\overline{U}	\overline{V}	D
			E
			F
\underline{T}	\underline{U}	\underline{V}	G
			H

Represents integer of output voltage

OUTPUT VOLTAGE (V)	MARK		
	A SERIES C SERIES F SERIES	B SERIES D SERIES G SERIES	E SERIES H SERIES
0.x	$\underline{0}$	$\overline{0}$	$\overline{0}$
0.x5	\underline{A}	\overline{A}	\overline{A}
1.x	$\underline{1}$	$\overline{1}$	$\overline{1}$
1.x5	\underline{B}	\overline{B}	\overline{B}
2.x	$\underline{2}$	$\overline{2}$	$\overline{2}$
2.x5	\underline{C}	\overline{C}	\overline{C}
3.x	$\underline{3}$	$\overline{3}$	$\overline{3}$
3.x5	\underline{D}	\overline{D}	\overline{D}
4.x	$\underline{4}$	$\overline{4}$	$\overline{4}$

Represents decimal point of output voltage and oscillation frequency

OUTPUT VOLTAGE (V)	MARKING	
	OSC=600kHz	OSC=1.2MHz
x.0	0	A
x.05	0	A
x.1	1	B
x.15	1	B
x.2	2	C
x.25	2	C
x.3	3	D
x.35	3	D
x.4	4	E
x.45	4	E
x.5	5	F
x.55	5	F
x.6	6	H
x.65	6	H
x.7	7	K
x.75	7	K
x.8	8	L
x.85	8	L
x.9	9	M
x.95	9	M

Represents production lot number

0 to 9, A to Z, reversed character of 0 to 9 and A to Z repeated (G, I, J, O, Q, W excepted)

MARKING RULE (Continued)

USP-6B

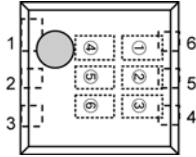

USP-6B (TOP VIEW)

Represents product series

MARK	PRODUCT SERIES
Z	XC9225xxxxxx
P	XC9226xxxxxx
R	XC9227xxxxxx

Represents the type of DC/DC converters

MARK	PRODUCT SERIES	MARK	PRODUCT SERIES
A	XC9225/26/27Axxxxx	E	XC9225/26/27Exxxxx
B	XC9225/26/27Bxxxxx	F	XC9225/26/27Fxxxxx
C	XC9225/26/27Cxxxxx	Z	XC9225/26/27Gxxxxx
D	XC9225/26/27Dxxxxx	H	XC9225/26/27Hxxxxx

Represents integer of output voltage

MARK	OUTPUT VOLTAGE (V)
0	0.xx
1	1.xx
2	2.xx
3	3.xx
4	4.xx

Represents decimal point of output voltage

MARK	OUTPUT VOLTAGE (V)	MARK	OUTPUT VOLTAGE (V)
0	x.00	A	x.05
1	x.10	B	x.15
2	x.20	C	x.25
3	x.30	D	x.35
4	x.40	E	x.45
5	x.50	F	x.55
6	x.60	H	x.65
7	x.70	K	x.75
8	x.80	L	x.85
9	x.90	M	x.95

Represents oscillation frequency

MARK	OSCILLATION FREQUENCY	PRODUCT SERIES
6	600kHz	XC9225/26/27xxx6xx
C	1.2MHz	XC9225/26/27xxxCxx

Represents production lot number

0 to 9 and A to Z repeated (G, I, J, O, Q, W excepted)

1. The products and product specifications contained herein are subject to change without notice to improve performance characteristics. Consult us, or our representatives before use, to confirm that the information in this datasheet is up to date.
2. We assume no responsibility for any infringement of patents, patent rights, or other rights arising from the use of any information and circuitry in this datasheet.
3. Please ensure suitable shipping controls (including fail-safe designs and aging protection) are in force for equipment employing products listed in this datasheet.
4. The products in this datasheet are not developed, designed, or approved for use with such equipment whose failure of malfunction can be reasonably expected to directly endanger the life of, or cause significant injury to, the user.
(e.g. Atomic energy; aerospace; transport; combustion and associated safety equipment thereof.)
5. Please use the products listed in this datasheet within the specified ranges.
Should you wish to use the products under conditions exceeding the specifications, please consult us or our representatives.
6. We assume no responsibility for damage or loss due to abnormal use.
7. All rights reserved. No part of this datasheet may be copied or reproduced without the prior permission of TOREX SEMICONDUCTOR LTD.

TOREX SEMICONDUCTOR LTD.