

## 2ch.Step-Up/Up DC/DC Controller ICs

☆GreenOperation Compatible

## ■GENERAL DESCRIPTION

The XC9501 series are PWM controlled, PWM/PFM automatic switching controlled, multi-functional, dual step-up DC/DC converter controller ICs.

With 0.9V ( $\pm 2\%$ ) of standard voltage supply internal, and using externally connected components, output voltage can be set freely on both DC/DC controllers between 1.5V to 30V.

With a 180kHz frequency, the size of the external components can be reduced. 100kHz, 300kHz and 500kHz switching frequencies are also available as custom-designed products.

The control of the XC9501 series can be switched between PWM control and PWM/PFM automatic switching control using external signals. Control switches from PWM to PFM during light loads when automatic switching is selected and the series is highly efficient from light loads to large output currents. Noise is easily reduced with PWM control since the switching frequency is fixed.

The XC9501 series provides the option of being able to select the control suited to the application.

Soft-start time is internally set to 10msec which offers protection against rush currents when the power is switched on and also against voltage overshoot.

## ■APPLICATIONS

- PDAs
- Palm top computers
- Portable audio systems
- Various multi-function power supplies

## ■FEATURES

- 2ch DC/DC Controller** : (Step-Up + Step-Up)
- Input Voltage Range** : 0.9V ~ 10V
- Supply Voltage Range** : 2.0V ~ 10V
- Output Voltage Range** : 1.5V ~ 30V (set by FB1/FB2 pins)
- Output Current** : More than 200mA  
( $V_{IN}=1.8V, V_{OUT}=3.3V$ )
- Switching Frequency** : 180kHz ( $\pm 15\%$ )  
100kHz, 300kHz & 500kHz  
as custom
- Maximum Duty Cycle** : 80% (TYP.)
- Control Method** : PWM or PWM/PFM Selectable
- High Efficiency** : 83% (TYP.)
- Stand-by Current** : 3.0  $\mu$  A (MAX.)
- Soft-start** : internally set-up
- Package** : MSOP-10, USP-10
- Environmentally Friendly**: EU RoHS Compliant, Pb Free

## ■TYPICAL APPLICATION CIRCUIT

(XC9501B092A Input: 2 cells, Output ①: 3.3V, Output ②: 5.0V)

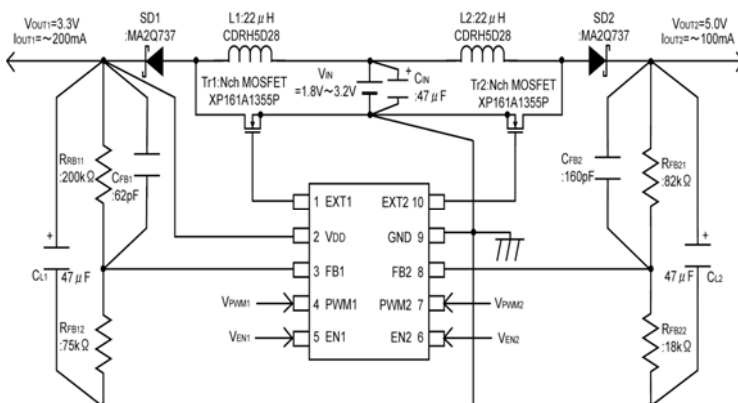

## ■TYPICAL PERFORMANCE CHARACTERISTICS

- Efficiency vs. Output Current

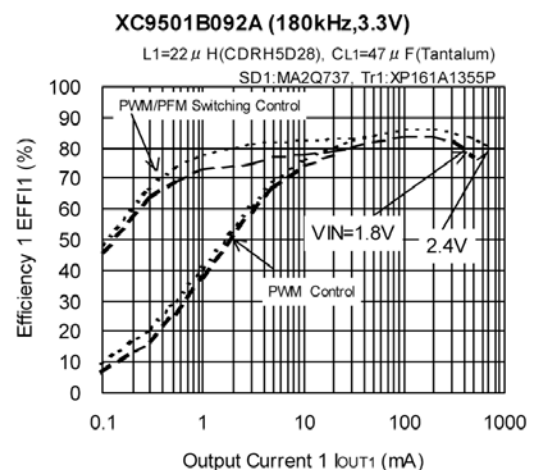

## PIN CONFIGURATION

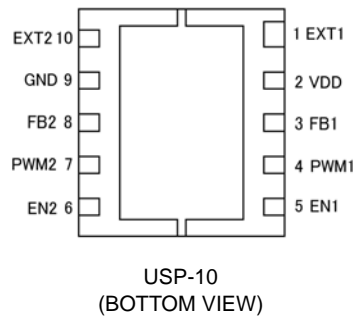
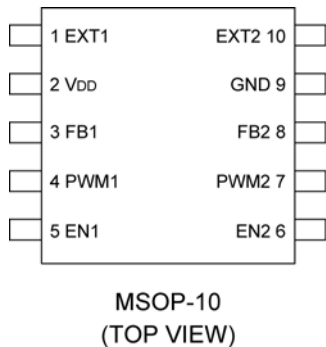

## PIN ASSIGNMENT

PIN NUMBER	PIN NAME	FUNCTION
1	EXT 1	Channel 1: External Transistor Drive Pin <Connected to N-ch Power MOSFET Gate>
2	VDD	Supply Voltage
3	FB1	Channel 1: Output Voltage Monitor Feedback Pin <Threshold value: 0.9V. Output Voltage can be set freely by connecting split resistor between V <sub>OUT1</sub> and GND.>
4	PWM1	Channel 1: PWM/PFM Switching Pin <Control Output 1. PMW control when connected to VDD, PWM/PFM auto Switching when connected to GND.>
5	EN1	Channel 1: Enable Pin <Connected to GND when Output 1 is in stand-by mode. Connected to VDD when Output 1 is active. EXT1 is low when in stand-by mode.>
6	EN2	Channel 2: Enable Pin <Connected to GND when Output 2 is in stand-by mode. Connected to VDD when Output 2 is active. EXT2 is high when in stand-by mode.>
7	PWM2	Channel 2: PWM/PFM Switching Pin <Control Output 2. PMW control when connected to VDD, PWM/PFM auto Switching when connected to GND.>
8	FB2	Channel 2: Output Voltage Monitor Feedback Pin <Threshold value: 0.9V. Output Voltage can be set freely by connecting split resistor between V <sub>OUT2</sub> and GND.>
9	GND	Ground
10	EXT2	Channel2: External Transistor Drive Pin <Connected to N-ch Power MOSFET Gate>

## PRODUCT CLASSIFICATION

### Ordering Information

XC9501 ①②③④⑤⑥-⑦<sup>(\*)</sup>

DESIGNATOR	DESCRIPTION	SYMBOL	DESCRIPTION
①	Type of DC/DC Controller	B	Standard (10 Pin)
②③	Output Voltage	09	FB Voltage: 0.9V
④	Oscillation Frequency	1	100kHz (custom)
		2	180kHz
		3	300kHz (custom)
		5	500kHz (custom)
⑤⑥-⑦	Packages Taping Type <sup>(*)</sup>	AR	MSOP-10
		AR-G	MSOP-10
		DR	USP-10
		DR-G	USP-10

<sup>(\*)</sup> The "-G" suffix indicates that the products are Halogen and Antimony free as well as being fully RoHS compliant.

<sup>(2)</sup> The device orientation is fixed in its embossed tape pocket. For reverse orientation, please contact your local Torex sales office or representative. (Standard orientation: ⑤R-⑦, Reverse orientation: ⑤L-⑦)

## ■ BLOCK DIAGRAM

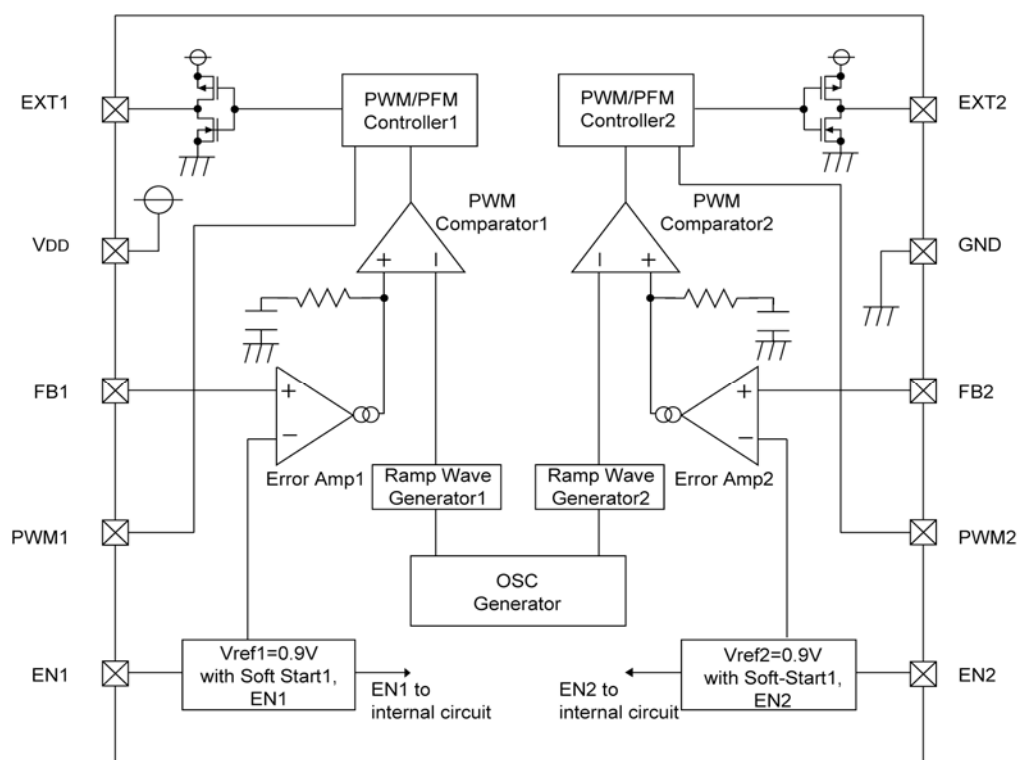

## ■ ABSOLUTE MAXIMUM RATINGS

Ta=25°C			
PARAMETER	SYMBOL	RATINGS	UNITS
VDD Pin Voltage	VDD	- 0.3 ~ 12.0	V
FB1, 2 Pin Voltage	VFB	- 0.3 ~ 12.0	V
EN1, 2 Pin Voltage	VEN	- 0.3 ~ 12.0	V
PWM1, 2 Pin Voltage	VPWM	- 0.3 ~ 12.0	V
EXT1, 2 Pin Voltage	VEXT	- 0.3 ~ VDD + 0.3	V
EXT1, 2 Pin Current	IEXT	±100	mA
Power Dissipation	MSOP-10	Pd	150
	USP-10		
Operating Temperature Range	Topr	- 40 ~ + 85	°C
Storage Temperature Range	Tstg	- 55 ~ + 125	°C

## ELECTRICAL CHARACTERISTICS

XC9501B091A Common Characteristics

(FOSC = 100kHz)

Ta=25°C

PARAMETER	SYMBOL	CONDITIONS	MIN.	TYP.	MAX.	UNITS	CIRCUIT	
Supply Voltage <sup>(*)</sup>	VDD		2.0	-	10.0	V	-	
Output Voltage Range <sup>(*)</sup>		VDD ≥ 2.0V IOUT1,2=1mA VOUT1, VOUT2	0.9	-	-	V	①	
		VIN ≥ 0.9V IOUT1,2=1mA <sup>(*)</sup>	VOUT1	2.0	-	10.0	V	②
			VOUT2	0.9	-	-	V	
		VIN ≥ 0.9V IOUT1,2=1mA <sup>(*)</sup>	VOUT1	0.9	-	-	V	③
	VOUT2	2.0	-	10.0	V			
Supply Current 1	IDD1	FB1, 2=0V	-	70	100	μA	④	
Supply Current 1-1	IDD1-1	EN1=3.0V, EN2=0V, FB1=0V	-	50	80	μA	④	
		EN2=3.0V, EN1=0V, FB2=0V						
Supply Current 1-2	IDD1-2	FB1=0V, FB2=1.0V	-	80	150	μA	④	
		FB1=1V, FB2=0V						
Supply Current 2	IDD2	FB1, 2=1.0V	-	60	90	μA	④	
Stand-by Current	ISTB	Same as IDD1, EN1=EN2=0V	-	-	3.0	μA	④	
Oscillation Frequency	FOSC	Same as IDD1	85	100	115	kHz	④	
EN1, 2 "High" Voltage	VENH	FB1, 2=0V	0.65	-	-	V	④	
EN1, 2 "Low" Voltage	VENL	FB1, 2=0V	-	-	0.20	V	④	
EN1, 2 "High" Current	IENH	FB1, 2=3.0V	-	-	0.50	μA	④	
EN1, 2 "Low" Current	IENL	EN1, 2=0V, FB1, 2=3.0V	-	-	-0.50	μA	④	
PWM1, 2 "High" Current	IPWMH	FB1, 2=3.0V, PWM=3.0V	-	-	0.50	μA	④	
PWM1, 2 "Low" Current	IPWML	FB1, 2=3.0V, PWM=0V	-	-	-0.50	μA	④	
FB1, 2 "High" Current	IFBH	FB1, 2=3.0V	-	-	0.50	μA	④	
FB1, 2 "Low" Current	VFBL	FB1, 2=1.0V	-	-	-0.50	μA	④	

Unless otherwise stated, VDD=3.0V, PWM1, 2=3.0V, EN1, 2 = 3.0V

Output 1 Characteristics Step-Up Controller

(FOSC = 100kHz)

Ta=25°C

PARAMETER	SYMBOL	CONDITIONS	MIN.	TYP.	MAX.	UNITS	CIRCUIT
FB1 Voltage	VFB1	VDD=3.0V, VIN=1.5V, IOUT1=10mA	0.882	0.900	0.918	V	⑤
Operation Start-up Voltage 1 <sup>(*)</sup>	VST1-1	Using Tr: 2SD1628, IOUT=1.0mA, RFB11=200kΩ, RFB12=75kΩ	-	-	0.9	V	②
		VDD ≠ VOUT1: IOUT1=1mA	-	-	2.0	V	①
Oscillation Start Voltage 1	VST2-1	FB1=0V	-	-	0.8	V	④
Maximum Duty Ratio 1	MAXDTY1	Same as IDD1	75	80	88	%	④
PFM Duty Ratio 1	PFMDTY1	No Load, VPWM1=0V	22	30	38	%	⑥
Efficiency 1	EFFI1	IOUT1=100mA N-ch MOSFET: XP161A1355P	-	83	-	%	⑥
Soft-Start Time 1	TSS1	VOUT1 × 0.95V, EN1=0V → 0.65V	5.0	10.0	20.0	ms	⑥
EXT1 "High" ON Resistance	REXTBH1	FB1=0, EXT1=VDD-0.4V	-	28	47	Ω	⑦
EXT1 "Low" ON Resistance	REXTBL1	EN1=FB2=0V, EXT1=0.4V	-	22	30	Ω	⑦
PWM1 "High" Voltage	VPWMH1	No Load	0.65	-	-	V	⑥
PWM1 "Low" Voltage	VPWML1	No Load	-	-	0.20	V	⑥

Unless otherwise stated, VDD=EN1=PWM1=3.0V, EN2=PWM2=GND, EXT2=OPEN, FB2=OPEN, VIN=1.8V

Output 2 Characteristics Step-Up Controller

(FOSC = 100kHz)

Ta=25°C

PARAMETER	SYMBOL	CONDITIONS	MIN.	TYP.	MAX.	UNITS	CIRCUIT
FB2 Voltage	VFB2	VDD=3.0V, VIN=1.5V, IOUT1=10mA	0.882	0.900	0.918	V	⑧
Operation Start-up Voltage 2 <sup>(*)</sup>	VST1-2	Using Tr: 2SD1628, IOUT1=1.0mA, RFB21=200kΩ, RFB22=75kΩ	-	-	0.9	V	③
		VDD ≠ VOUT2: IOUT2=1mA	-	-	2.0	V	①
Oscillation Start Voltage 2	VST2-2	FB2=0V	-	-	0.8	V	④
Maximum Duty Ratio 2	MAXDTY2	Same as IDD1	75	80	85	%	④
PFM Duty Ratio 2	PFMDTY2	No Load, VPWM2=0V	22	25	38	%	⑨
Efficiency 2	EFFI2	IOUT2=100mA, N-ch MOSFET: XP161A1355P	-	83	-	%	⑨
Soft-Start Time 2	TSS2	VOUT1 × 0.95V, EN2=0V → 0.65V	5.0	10.0	20.0	ms	⑨
EXT2 "High" ON Resistance	REXTBH2	FB2=0, EXT2=VDD-0.4V	-	28	47	Ω	⑦
EXT2 "Low" ON Resistance	REXTBL2	EN2=FB2=0V, EXT2=0.4V	-	22	30	Ω	⑦
PWM2 "High" Voltage	VPWMH2	No Load	0.65	-	-	V	⑨
PWM2 "Low" Voltage	VPWML2	No Load	-	-	0.20	V	⑨

Unless otherwise stated, VDD=EN2=PWM2=3.0V, PWM1=EN1=GND, EXT1=OPEN, FB1=OPEN, VIN=1.8V

## ■ ELECTRICAL CHARACTERISTICS (Continued)

XC9501B092A Common Characteristics

(FOSC = 180kHz)

Ta=25°C

PARAMETER	SYMBOL	CONDITIONS	MIN.	TYP.	MAX.	UNITS	CIRCUIT
Supply Voltage <sup>( * 1 )</sup>	VDD		2.0	-	10.0	V	-
Output Voltage Range <sup>( * 4 )</sup>		VDD ≥ 2.0V IOUT1,2=1mA VOUT1, VOUT2	0.9	-	-	V	①
		VIN ≥ 0.9V IOUT1,2=1mA <sup>( * 2 )</sup> VOUT1	2.0	-	10.0	V	②
		VOUT2	0.9	-	-	V	
		VIN ≥ 0.9V IOUT1,2=1mA <sup>( * 3 )</sup> VOUT1	0.9	-	-	V	③
VOUT2	2.0	-	10.0	V			
Supply Current 1	IDD1	FB1, 2=0V	-	90	160	μA	④
Supply Current 1-1	IDD1-1	EN1=3.0V, EN2=0V, FB1=0V	-	60	120	μA	④
		EN2=3.0V, EN1=0V, FB2=0V					
Supply Current 1-2	IDD1-2	FB1=0V, FB2=1.0V	-	80	150	μA	④
		FB1=1V, FB2=0V					
Supply Current 2	IDD2	FB1, 2=1.0V	-	70	132	μA	④
Stand-by Current	ISTB	Same as IDD1, EN1=EN2=0V	-	-	3.0	μA	④
Oscillation Frequency	FOSC	Same as IDD1	153	180	207	kHz	④
EN1, 2 "High" Voltage	VENH	FB1, 2=0V	0.65	-	-	V	④
EN1, 2 "Low" Voltage	VENL	FB1, 2=0V	-	-	0.20	V	④
EN1, 2 "High" Current	IENH	FB1, 2=3.0V	-	-	0.50	μA	④
EN1, 2 "Low" Current	IENL	EN1, 2=0V, FB1, 2=3.0V	-	-	-0.50	μA	④
PWM1, 2 "High" Current	IPWMH	FB1, 2=3.0V, PWM=3.0V	-	-	0.50	μA	④
PWM1, 2 "Low" Current	IPWML	FB1, 2=3.0V, PWM=0V	-	-	-0.50	μA	④
FB1, 2 "High" Current	IFBH	FB1, 2=3.0V	-	-	0.50	μA	④
FB1, 2 "Low" Current	VFBL	FB1, 2=1.0V	-	-	-0.50	μA	④

Unless otherwise stated, VDD=3.0V, PWM1, 2=3.0V, EN1, 2 = 3.0V

Output 1 Characteristics Step-Up Controller

(FOSC = 180kHz)

Ta=25°C

PARAMETER	SYMBOL	CONDITIONS	MIN.	TYP.	MAX.	UNITS	CIRCUIT
FB1 Voltage	VFB1	VDD=3.0V, VIN=1.5V, IOUT1=10mA	0.882	0.900	0.918	V	⑤
Operation Start-up Voltage 1 <sup>( * 2 )</sup>	VST1-1	Using Tr: 2SD1628, IOUT=1.0mA, RFB11=200kΩ, RFB12=75kΩ	-	-	0.9	V	②
		VDD ≠ VOUT1: IOUT1=1mA	-	-	2.0	V	①
Oscillation Start Voltage 1	VST2-1	FB1=0V	-	-	0.8	V	④
Maximum Duty Ratio 1	MAXDTY1	Same as IDD1	75	80	88	%	④
PFM Duty Ratio 1	PFMDTY1	No Load, VPWM1=0V	22	30	38	%	⑥
Efficiency 1	EFFI1	IOUT1=100mA N-ch MOSFET: XP161A1355P	-	83	-	%	⑥
Soft-Start Time 1	TSS1	VOUT1 × 0.95V, EN1=0V → 0.65V	5.0	10.0	20.0	ms	⑥
EXT1 "High" ON Resistance	REXTBH1	FB1=0, EXT1=VDD-0.4V	-	28	47	Ω	⑦
EXT1 "Low" ON Resistance	REXTBL1	EN1=FB2=0V, EXT1=0.4V	-	22	30	Ω	⑦
PWM1 "High" Voltage	VPWMH1	No Load	0.65	-	-	V	⑥
PWM1 "Low" Voltage	VPWML1	No Load	-	-	0.20	V	⑥

Unless otherwise stated, VDD=EN1=PWM1=3.0V, EN2=PWM2=GND, EXT2=OPEN, FB2=OPEN, VIN=1.8V

Output 2 Characteristics Step-Up Controller

(FOSC = 180kHz)

Ta=25°C

PARAMETER	SYMBOL	CONDITIONS	MIN.	TYP.	MAX.	UNITS	CIRCUIT
FB2 Voltage	VFB2	VDD=3.0V, VIN=1.5V, IOUT1=10mA	0.882	0.900	0.918	V	⑧
Operation Start-up Voltage 2 <sup>( * 3 )</sup>	VST1-2	Using Tr: 2SD1628, IOUT1=1.0mA, RFB21=200kΩ, RFB22=75kΩ	-	-	0.9	V	③
		VDD ≠ VOUT2: IOUT2=1mA	-	-	2.0	V	①
Oscillation Start Voltage 2	VST2-2	FB2=0V	-	-	0.8	V	④
Maximum Duty Ratio 2	MAXDTY2	Same as IDD1	75	80	85	%	④
PFM Duty Ratio 2	PFMDTY2	No Load, VPWM2=0V	22	25	38	%	⑨
Efficiency 2	EFFI2	IOUT2=100mA, N-ch MOSFET: XP161A1355P	-	83	-	%	⑨
Soft-Start Time 2	TSS2	VOUT1 × 0.95V, EN2=0V → 0.65V	5.0	10.0	20.0	ms	⑨
EXT2 "High" ON Resistance	REXTBH2	FB2=0, EXT2=VDD-0.4V	-	28	47	Ω	⑦
EXT2 "Low" ON Resistance	REXTBL2	EN2=FB2=0V, EXT2=0.4V	-	22	30	Ω	⑦
PWM2 "High" Voltage	VPWMH2	No Load	0.65	-	-	V	⑨
PWM2 "Low" Voltage	VPWML2	No Load	-	-	0.20	V	⑨

Unless otherwise stated, VDD=EN2=PWM2=3.0V, PWM1=EN1=GND, EXT1=OPEN, FB1=OPEN, VIN=1.8V

## ELECTRICAL CHARACTERISTICS (Continued)

XC9501B093A Common Characteristics

(FOSC = 300kHz)

Ta=25°C

PARAMETER	SYMBOL	CONDITIONS	MIN.	TYP.	MAX.	UNITS	CIRCUIT	
Supply Voltage <sup>(1)</sup>	VDD		2.0	-	10.0	V		
Output Voltage Range <sup>(4)</sup>	VOUTSET	VDD ≥ 2.0V, IOUT1,2 = 1mA VOUT1, VOUT2	0.9	-	-	V	①	
		VIN ≥ 0.9V, IOUT1,2 = 1mA <sup>(2)</sup>	VOUT1	2.0	-	10.0	V	②
			VOUT2	0.9	-	-	V	
		VIN ≥ 0.9V, IOUT1,2 = 1mA <sup>(3)</sup>	VOUT1	0.9	-	-	V	③
	VOUT2	2.0	-	10.0	V			
Supply Current 1	IDD1	FB1, 2=0V	-	110	250	μA	④	
Supply Current 1-1	IDD1-1	EN1=3.0V, EN2=0V, FB1=0V	-	80	150	μA	④	
		EN2=3.0V, EN1=0V, FB2=0V						
Supply Current 1-2	IDD1-2	FB1=0V, FB2=1.0V	-	90	200	μA	④	
		FB1=1.0V, FB2=0V						
Supply Current 2	IDD2	FB1, 2=1.0V	-	80	160	μA	④	
Stand-by Current	ISTB	Same as IDD1, EN1=EN2=0V	-	-	3.0	μA	④	
Oscillation Frequency	FOSC	Same as IDD1	255	300	345	kHz	④	
EN1, 2 "High" Voltage	VENH	FB1, 2=0V	0.65	-	-	V	④	
EN1, 2 "Low" Voltage	VENL	FB1, 2=0V	-	-	0.20	V	④	
EN1, 2 "High" Current	IENH	FB1, 2=3.0V	-	-	0.50	μA	④	
EN1, 2 "Low" Current	IENL	EN1, 2=0V, FB1, 2=3.0V	-	-	-0.50	μA	④	
PWM1, 2 "High" Current	IPWMH	FB1, 2=3.0V, PWM=3.0V	-	-	0.50	μA	④	
PWM1, 2 "Low" Current	IPWML	FB1, 2=3.0V, PWM=0V	-	-	-0.50	μA	④	
FB1, 2 "High" Current	IFBH	FB1, 2=3.0V	-	-	0.50	μA	④	
FB1, 2 "Low" Current	VFBL	FB1, 2=1V	-	-	-0.50	μA	④	

Unless otherwise stated, VDD=3.0V, PWM1, 2=3.0V, EN1, 2 =3.0V

Output 1 Characteristics Step-Up Controller

(FOSC = 300kHz)

Ta=25°C

PARAMETER	SYMBOL	CONDITIONS	MIN.	TYP.	MAX.	UNITS	CIRCUIT
FB1 Voltage	VFB1	VDD=3.0V, VIN=1.5V, IOUT1=10mA	0.882	0.900	0.918	V	⑤
Operation Start Voltage 1 <sup>(2)</sup>	VST1-1	Using Tr: 2SD1628, IOUT=1.0mA, RFB11=200kΩ, RFB12=75kΩ	-	-	0.9	V	②
		VDD ≠ VOUT1: IOUT1=1mA	-	-	2.0	V	①
		FB1=0V	-	-	0.8	V	④
Oscillation Start Voltage 1	VST2-1	FB1=0V	-	-	0.8	V	④
Maximum Duty Ratio 1	MAXDTY1	Same as IDD1	75	80	85	%	④
PFM Duty Ratio 1	PFMDTY1	No Load, VPWM1=0V	22	30	38	%	⑥
Efficiency 1	EFF1	IOUT1=100mA, N-ch MOSFET: XP161A1355P	-	83	-	%	⑥
Soft-Start Time 1	TSS1	VOUT1 × 0.95V, CE1=0V → 0.65V	5.0	10.0	20.0	ms	⑥
EXT1 "High" ON Resistance	REXTBH1	FB1=0, EXT1=VDD-0.4V	-	28	47	Ω	⑦
EXT1 "Low" ON Resistance	REXTBL1	EN1=FB2=0V, EXT1=0.4V	-	22	30	Ω	⑦
PWM1 "High" Voltage	VPWMH1	No Load	0.65	-	-	V	⑥
PWM1 "Low" Voltage	VPWML1	No Load	-	-	0.20	V	⑥

Unless otherwise stated, VDD=EN1=PWM1=3.0V, EN2=PWM2=GND, EXT2=OPEN, FB2=OPEN, VIN=1.8V

Output 2 Characteristics Step-Up Controller

(FOSC = 300kHz)

Ta=25°C

PARAMETER	SYMBOL	CONDITIONS	MIN.	TYP.	MAX.	UNITS	CIRCUIT
FB2 Voltage	VFB2	VDD=3.0V, VIN=1.5V, IOUT2=10mA	0.882	0.900	0.918	V	⑧
Operation Start Voltage 2 <sup>(3)</sup>	VST1-2	Using Tr: 2SD1628, IOUT2=1.0mA, RFB21=200kΩ, RFB22=75kΩ	-	-	0.9	V	③
		VDD ≠ VOUT2: IOUT2=1mA	-	-	2.0	V	①
		FB2=0V	-	-	0.8	V	④
Oscillation Start-up Voltage2	VST2-2	FB2=0V	-	-	0.8	V	④
Maximum Duty Ratio 2	MAXDTY2	Same as IDD1	75	80	85	%	④
PFM Duty Ratio 2	PFMDTY2	No Load, VPWM2=0V	22	30	38	%	⑨
Efficiency 2	EFFI2	IOUT2=100mA, N-ch MOSFET: XP161A1355P	-	83	-	%	⑨
Soft-Start Time 2	TSS2	VOUT2 × 0.95V, EN2=0V → 0.65V	5.0	10.0	20.0	ms	⑨
EXT2 "High" ON Resistance	REXTBH2	FB2=0, EXT2=VDD-0.4V	-	28	47	Ω	⑦
EXT2 "Low" ON Resistance	REXTBL2	EN2=FB2=0V, EXT2=0.4V	-	22	30	Ω	⑦
PWM2 "High" Voltage	VPWMH2	No Load	0.65	-	-	V	⑨
PWM2 "Low" Voltage	VPWML2	No Load	-	-	0.20	V	⑨

Unless otherwise stated, VDD=EN2=PWM2=3.0V, PWM1=EN1=GND, EXT1=OPEN, FB1=OPEN, VIN=1.8V

## ■ ELECTRICAL CHARACTERISTICS (Continued)

XC9501B095A Common Characteristics (FOSC = 500kHz) Ta=25°C

PARAMETER	SYMBOL	CONDITIONS	MIN.	TYP.	MAX.	UNITS	CIRCUIT	
Supply Voltage <sup>(1)</sup>	VDD		2.0	-	10.0	V		
Output Voltage Range <sup>(4)</sup>	VOUTSET	VDD ≥ 2.0V, IOUT1,2 = 1mA VOUT1, VOUT2	0.9	-	-	V	①	
		VIN ≥ 0.9V, IOUT1,2 = 1mA <sup>(2)</sup>	VOUT1	2.0	-	10.0	V	②
			VOUT2	0.9	-	-	V	
		VIN ≥ 0.9V, IOUT1,2 = 1mA <sup>(3)</sup>	VOUT1	0.9	-	-	V	③
	VOUT2	2.0	-	10.0	V			
Supply Current 1	IDD1	FB1, 2=0V	-	165	350	μA	④	
Supply Current 1-1	IDD1-1	EN1=3.0V, EN2=0V, FB1=0V	-	110	220	μA	④	
		EN2=3.0V, EN1=0V, FB2=0V						
Supply Current 1-2	IDD1-2	FB1=0V, FB2=1.0V	-	130	270	μA	④	
		FB1=1.0V, FB2=0V						
Supply Current 2	IDD2	FB1, 2=1.0V	-	100	200	μA	④	
Stand-by Current	ISTB	Same as IDD1, EN1=EN2=0V	-	-	3.0	μA	④	
Switching Frequency	FOSC	Same as IDD1	425	500	575	kHz	④	
EN1, 2 "High" Voltage	VENH	FB1, 2=0V	0.65	-	-	V	④	
EN1, 2 "Low" Voltage	VENL	FB1, 2=0V	-	-	0.20	V	④	
EN1, 2 "High" Current	IENH	FB1, 2=3.0V	-	-	0.50	μA	④	
EN1, 2 "Low" Current	IENL	EN1, 2=0V, FB1,2=3.0V	-	-	-0.50	μA	④	
PWM1, 2 "High" Current	IPWMH	FB1, 2=3.0V, PWM=3.0V	-	-	0.50	μA	④	
PWM1, 2 "Low" Current	IPWML	FB1, 2=3.0V, PWM=0V	-	-	-0.50	μA	④	
FB1, 2 "High" Current	IFBH	FB1, 2=3.0V	-	-	0.50	μA	④	
FB1, 2 "Low" Current	VFBL	FB1, 2=1.0V	-	-	-0.50	μA	④	

Unless otherwise stated, VDD=3.0V, PWM1, 2=3.0V, EN1, 2 =3.0V

Output 1 Characteristics Step-Up Controller (FOSC = 500kHz) Ta=25°C

PARAMETER	SYMBOL	CONDITIONS	MIN.	TYP.	MAX.	UNITS	CIRCUIT
FB1 Voltage	VFB1	VDD=3.0V, VIN=1.5V, IOUT1=10mA	0.882	0.900	0.918	V	⑤
Operation Start Voltage 1 <sup>(2)</sup>	VST1-1	Using Tr: 2SD1628, IOUT=1.0mA, RFB11=200kΩ, RFB12=75kΩ	-	-	0.9	V	②
		VDD ≠ VOUT1: IOUT1=1mA	-	-	2.0	V	①
Oscillation Start Voltage 1	VST2-1	FB1=0V	-	-	0.8	V	④
Maximum Duty Ratio 1	MAXDTY1	Same as IDD1	75	80	85	%	④
PFM Duty Ratio 1	PFMDTY1	No Load, VPWM1=0V	22	30	38	%	⑥
Efficiency 1	EFFI1	IOUT1=100mA, N-ch MOSFET: XP161A1355P	-	83	-	%	⑥
Soft-Start Time 1	TSS1	VOUT1 × 0.95V, CE1=0V → 0.65V	5.0	10.0	20.0	ms	⑥
EXT1 "High" ON Resistance	REXTBH1	FB1=0, EXT1=VDD-0.4V	-	28	47	Ω	⑦
EXT1 "Low" ON Resistance	REXTBL1	EN1=FB2=0V, EXT1=0.4V	-	22	30	Ω	⑦
PWM1 "High" Voltage	VPWMH1	No Load	0.65	-	-	V	⑥
PWM1 "Low" Voltage	VPWML1	No Load	-	-	0.20	V	⑥

Unless otherwise stated, VDD=EN1=PWM1=3.0V, EN2=PWM2=GND, EXT2=OPEN, FB2=OPEN, VIN=1.8V

Output 2 Characteristics Step-Up Controller (FOSC = 500kHz) Ta=25°C

PARAMETER	SYMBOL	CONDITIONS	MIN.	TYP.	MAX.	UNITS	CIRCUIT
FB2 Voltage	VFB2	VDD=3.0V, VIN=1.5V, IOUT2=10mA	0.882	0.900	0.918	V	⑧
Operation Start Voltage 2 <sup>(3)</sup>	VST1-2	Using Tr: 2SD1628, IOUT2=1.0mA, RFB21=200kΩ, RFB22=75kΩ	-	-	0.9	V	③
		VDD ≠ VOUT2: IOUT2=1mA	-	-	2.0	V	①
Oscillation Start Voltage 2	VST2-2	FB2=0V	-	-	0.8	V	④
Maximum Duty Ratio 2	MAXDTY2	Same as IDD1	75	80	85	%	④
PFM Duty Ratio 2	PFMDTY2	No Load, VPWM2=0V	22	30	38	%	⑨
Efficiency 2	EFFI2	IOUT2=100mA, N-ch MOSFET: XP161A1355P	-	83	-	%	⑨
Soft-Start Time 2	TSS2	VOUT2 × 0.95V, EN2=0V → 0.65V	5.0	10.0	20.0	ms	⑨
EXT2 "High" ON Resistance	REXTBH2	FB2=0, EXT2=VDD-0.4V	-	28	47	Ω	⑦
EXT2 "Low" ON Resistance	REXTBL2	EN2=FB2=0V, EXT2=0.4V	-	22	30	Ω	⑦
PWM2 "High" Voltage	VPWMH2	No Load	0.65	-	-	V	⑨
PWM2 "Low" Voltage	VPWML2	No Load	-	-	0.20	V	⑨

Unless otherwise stated, VDD=EN2=PWM2=3.0V, PWM1=EN1=GND, EXT1=OPEN, FB1=OPEN, VIN=1.8V

## ELECTRICAL CHARACTERISTICS (Continued)

Notes:

- \* 1: Although the IC's step-up operations start from a  $V_{DD}$  of 0.8V, the output voltage and switching frequency are stabilized at  $V_{DD} \geq 2.0V$ . Therefore, a  $V_{DD}$  of more than 2.0V is recommended when  $V_{DD}$  is supplied from  $V_{IN}$  or other power sources.
- \* 2: Although the IC's switching operations start from a  $V_{IN}$  of 0.9V, the IC's power supply pin ( $V_{DD}$ ) and output voltage monitor pin ( $FB1$ ) should be connected to  $V_{OUT1}$ . With operations from  $V_{IN}=0.9V$ , the 2nd channel's (output 2)  $EN2$  pin should be set to disable. Once output voltage  $V_{OUT1}$  is more than 2.0V, the  $EN2$  pin should be set to enable.
- \* 3: Although the IC's switching operations start from a  $V_{IN}$  of 0.9V, the IC's power supply pin ( $V_{DD}$ ) and output voltage monitor pin ( $FB2$ ) should be connected to  $V_{OUT2}$ . With operations from  $V_{IN}=0.9V$ , the 1st channel's (output 1)  $EN1$  pin should be set to disable. Once output voltage  $V_{OUT2}$  is more than 2.0V, the  $EN1$  pin should be set to enable.
- \* 4: Please be careful not to exceed the breakdown voltage level of the external components. We recommend, as a guideline, that a level equal to more than 3 times that of the set output voltage be used.
- \* 5:  $EFF1 = \left\{ \left[ (\text{output voltage}) \times (\text{output current}) \right] / \left[ (\text{input voltage}) \times (\text{input current}) \right] \right\} \times 100$

## TYPICAL APPLICATION CIRCUITS

①  $V_{DD}=V_{OUT1}$  Connection Example

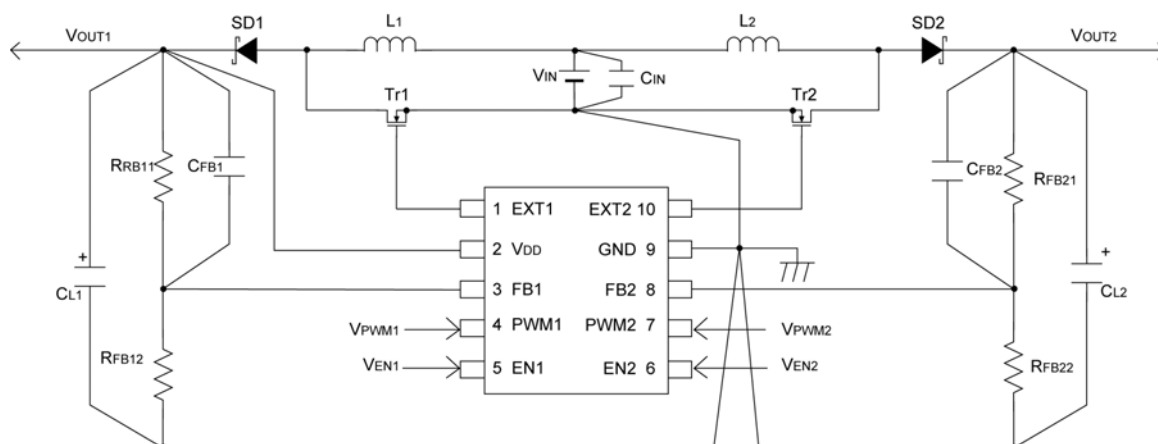

②  $V_{DD}=V_{IN}$  Connection Example

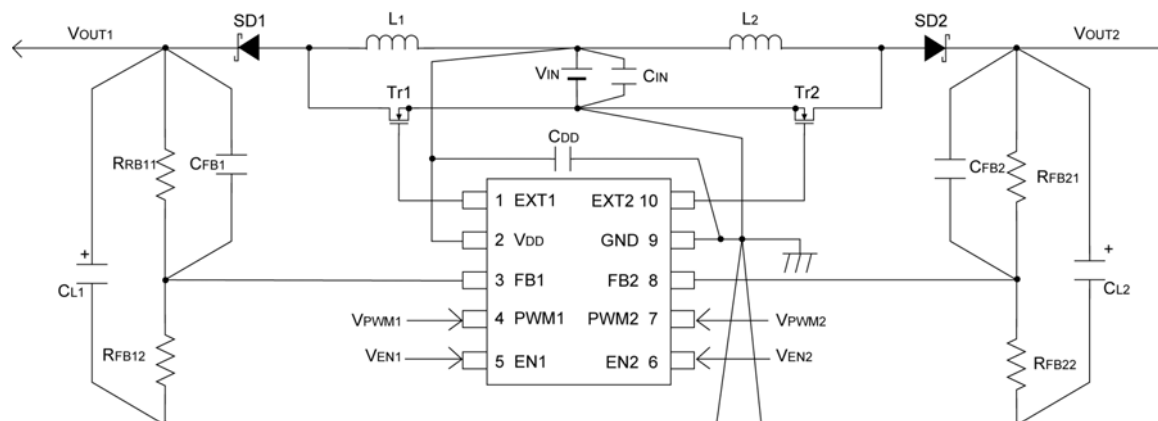



## ■ OPERATIONAL EXPLANATION

The XC9501series are multi-functional, 2 channel step-up DC/DC converter controller ICs with built-in high speed, low ON resistance drivers.

### <Error Amp. 1, 2>

The error amplifier is designed to monitor the output voltage and it compares the feedback voltage (FB) with the reference voltage. In response to feedback of a voltage lower than the reference voltage, the output voltage of the error amp. decreases.

### <OSC Generator>

This circuit generates the switching frequency, which in turn generates the reference clock.

### <Ramp Wave Generator1, 2>

The ramp wave generator generates a saw-tooth waveform based on outputs from the Phase Shift Generator.

### <PWM Comparator1, 2>

The PWM Comparator compares outputs from the error amp. and saw-tooth waveform. When the voltage from the error amp's output is low, the external switch will be set to ON.

### <PWM/PFM Controller1, 2>

This circuit generates PFM pulses.

Control can be switched between PWM control and PWM/PFM automatic switching control using external signals.

The PWM/PFM automatic switching mode is selected when the voltage of the PWM1 (2) pin is less than 0.2V, and the control switches between PWM and PFM automatically depending on the load. As the PFM circuit generates pulses based on outputs from the PWM comparator, shifting between modes occurs smoothly. PWM control mode is selected when the voltage of the PWM1 (2) pin is more than 0.65V. Noise is easily reduced with PWM control since the switching frequency is fixed.

Control suited to the application can easily be selected which is useful in audio applications, for example, where traditionally, efficiencies have been sacrificed during stand-by as a result of using PWM control (due to the noise problems associated with the PFM mode in stand-by).

### <Vref with Soft Start1, 2>

The reference voltage, Vref (FB pin voltage)=0.9V, is adjusted and fixed by laser trimming (for output voltage settings, please refer to the notes on next page). To protect against inrush current, when the power is switched on, and also to protect against voltage overshoot, soft-start time is set internally to 10ms. It should be noted, however, that this circuit does not protect the load capacitor (CL) from inrush current. With the Vref voltage limited and depending upon the input to the error amps, the operation maintains a balance between the two inputs of the error amps and controls the EXT pin's ON time so that it doesn't increase more than is necessary.

### <Enable Function>

This function controls the operation and shutdown of the IC. When the voltage of the EN1 or EN2 pins is 0.2V or less, the mode will be disable, the channel's operations will stop and the EXT pin will be kept at a low level (the external N-ch MOSFET will be OFF). When both EN1 and EN2 are in a state of disable, current consumption will be no more than 3.0  $\mu$  A.

When the EN1 or EN2 pin's voltage is 0.65V or more, the mode will be enable and operations will recommence. With soft-start, 95% of the set output voltage will be reached within 10mS (TYP.) from the moment of enable.

The start-up sequence for EN1 and EN2 is required when operations begin with a power supply voltage of VDD<2.0V or less. Although IC 1 starts oscillation from a VIN of 0.9V, the IC's power supply pin (VDD) and the output voltage monitor pin (FB1) should be connected to VOUT1. When the IC starts operations from a VIN of 0.9V, set channel two's (output 2) EN2 pin to disable and turn it to enable when VOUT1 is more than 2.0V. Conversely, when IC 2's power supply pin (VDD) and output voltage monitor pin (FB2) are connected to VOUT2, set channel one's (output 1) EN1 pin to disable and turn it to enable when VOUT2 is more than 2.0V.

For power supply voltages of VDD<2.0V, oscillation may occur irrespective of the FB pin voltage. Should this happen, you may find that output voltage will be higher than the set voltage. The FB pin voltage and the reference voltage Vref will be compared and output voltage will be controlled when the power supply voltage is VDD>2.0V or more. With power supply voltages of VDD>2.0V, the start-up sequence for EN1 and EN2 will not be required.

## OPERATIONAL EXPLANATION (Continued)

### <Output Voltage Setting>

Output voltage can be set by adding external split resistors. Output voltage is determined by the following equation, based on the values of RFB11 (RFB21) and RFB12 (RFB22). The sum of RFB11 (RFB21) and RFB12 (RFB22) should normally be 1MΩ or less.

$$V_{OUT} = 0.9 \times (R_{FB11} + R_{FB12}) / R_{FB12}$$

The value of CFB1 (CFB2), speed-up capacitor for phase compensation, should be resulted  $f_{zfb} = 1 / (2 \pi \times C_{FB1} \times R_{FB11})$  equal to 12kHz. Adjustments are required from 1kHz to 50kHz depending on the application, value of inductance (L), and value of load capacity (CL).

### [Example of Calculation]

When RFB11=200kΩ and RFB12=75kΩ,  $V_{OUT1} = 0.9 \times (200k + 75k) / 75k = 3.3V$ .

### [Typical Example]

V <sub>OUT</sub> (V)	R <sub>FB11</sub> (kΩ)	R <sub>FB12</sub> (kΩ)	C <sub>FB1</sub> (pF)	V <sub>OUT</sub> (V)	R <sub>FB11</sub> (kΩ)	R <sub>FB12</sub> (kΩ)	C <sub>FB1</sub> (pF)	V <sub>OUT</sub> (V)	R <sub>FB11</sub> (kΩ)	R <sub>FB12</sub> (kΩ)	C <sub>FB1</sub> (pF)
1.5	220	330	62	2.7	360	180	33	12.0	160	13	82
1.8	220	220	62	3.0	560	240	24	-	-	-	-
2.0	330	270	39	3.3	200	75	62	-	-	-	-
2.2	390	270	33	5.0	82	18	160	-	-	-	-
2.5	390	220	33	8.0	120	15	100	-	-	-	-

The same method can be also adopted for channel two (output 2).

### [External Components]

Tr : \* MOSFET

XP161A1355PR (N-ch Power MOSFET, TOREX)

Note: V<sub>GS</sub> breakdown voltage of this Transistor is 8V so please be careful with the power supply voltage. If the power supply voltage is more than 6V, please use XP161A1265PR, where V<sub>GS</sub> breakdown voltage is 12V. V<sub>ST1</sub> of XP161A1355PR is 1.2V (MAX.) and that of XP161A1265PR is 1.5V (MAX.)

\* NPN Transistor

2SD1628 (SANYO)

R<sub>B</sub> : 500Ω

(Adjust in accordance with load & Tr.'s HFE.)

C<sub>B</sub> : 2200pF (Ceramic)

Set up according to the equation below.

$$C_B \leq 1 / (2 \pi \times R_B \times F_{osc} \times 0.7)$$

SD : MA2Q737 (Schottky, MATSUSHITA)

CMS02 (Schottky, TOSHIBA)

L : 47 μH (CDRH5D28, SUMIDA, FOSC = 100kHz)

22 μH (CDRH5D28, SUMIDA, FOSC = 180kHz)

15 μH (CDRH5D28, SUMIDA, FOSC = 300kHz)

10 μH (CDRH5D28, SUMIDA, FOSC = 500kHz)

CL : 16V, 47 μF (Tantalum, NICHICHEMI, MCE Series)

Increase capacity according to the equation below when the step-up voltage ratio is large and output current is high.

$$C_L = (C_L \text{ standard value}) \times (I_{OUT} \text{ (mA)} / 300\text{mA}) \times V_{OUT} / V_{IN}$$

**TEST CIRCUITS**

Circuit 1

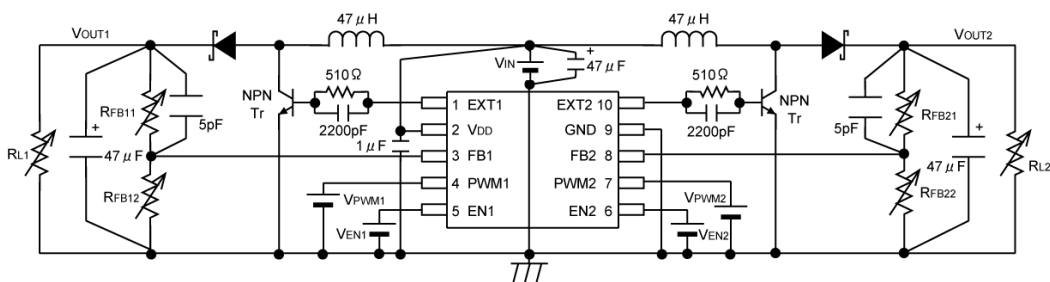

Circuit 2

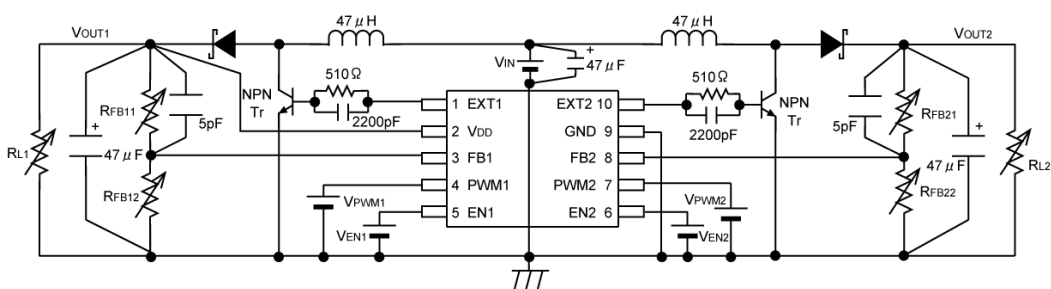

Circuit 3

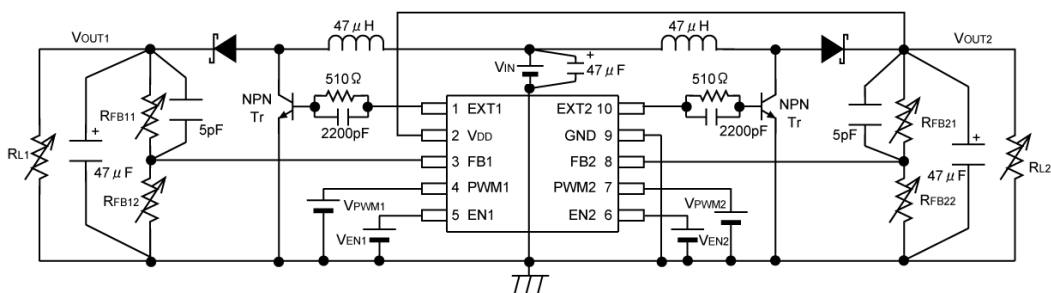

Circuit 4

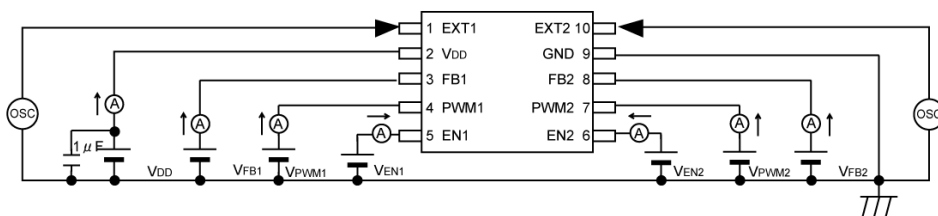

Circuit 5

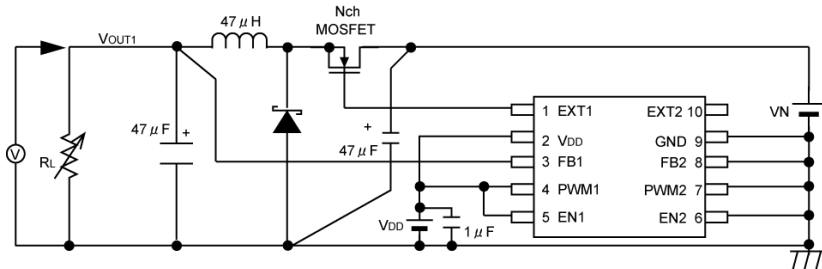

## TEST CIRCUITS (Continued)

Circuit 6

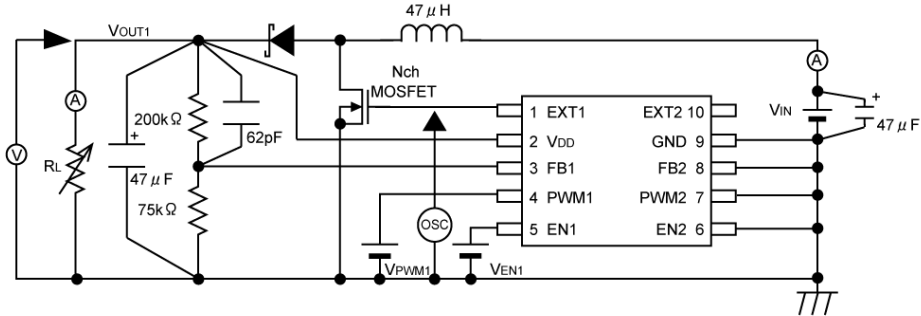

Circuit 7

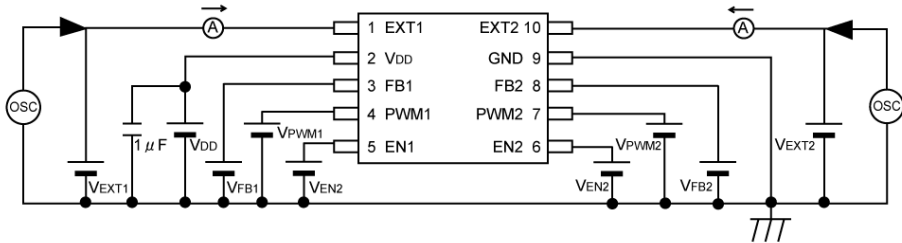

Circuit 8

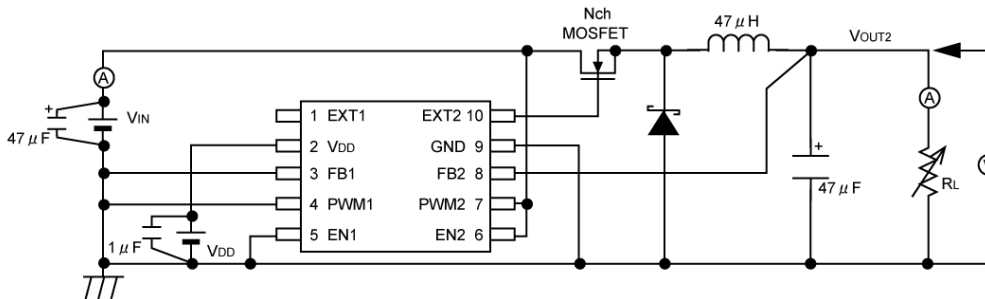

Circuit 9

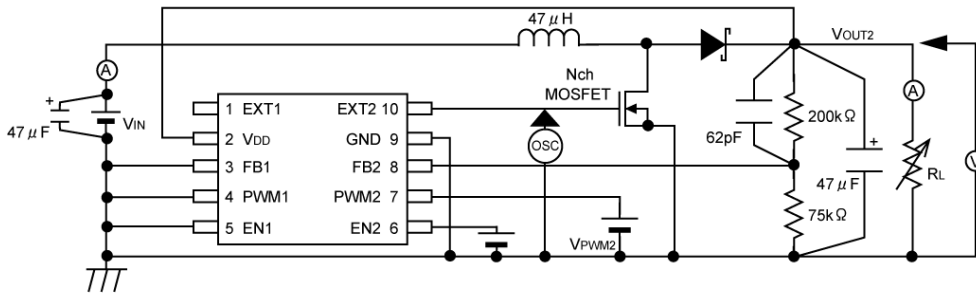

## EXTERNAL COMPONENTS

### Circuit 1, Circuit 2, and Circuit 3

L1, L2 :	47 $\mu$ H (CDRH5D28, SUMIDA)	: XC9501B091A
	22 $\mu$ H (CDRH5D28, SUMIDA)	: XC9501B092A
	15 $\mu$ H (CDRH5D28, SUMIDA)	: XC9501B093A
	10 $\mu$ H (CDRH5D28, SUMIDA)	: XC9501B095A
SD1, SD2 :	CRS02 (Schottky diode, TOSHIBA)	
	EC10QS06 (Schottky diode, NIHON INTER)	
CL1, CL2 :	16MCE476MD2 (Tantalum, NIHON CHEMICON)	
	35MCE335MB2 (Tantalum, NIHON CHEMICON)	
C <sub>IN</sub> :	16MCE476MD2 (Tantalum, NIHON CHEMICON)	
NPN Tr1, 2:	2SA1628 (SANYO)	
	CPH3215 (SANYO)	
	CPH3210 (SANYO)	
RFB :	Please use by the conditions as below.	
	$R_{FB11} + R_{FB12} \leq 1M\Omega$	
	$R_{FB21} + R_{FB22} \leq 1M\Omega$	
	$R_{FB11} / R_{FB12} = (\text{Setting Output Voltage} / 0.9) - 1$	
	$R_{FB21} / R_{FB22} = (\text{Setting Output Voltage} / 0.9) - 1$	
CFB :	Please adjust as below:	
	$f_{zfb} = 1 / (2 \times \pi \times C_{FB1} \times R_{FB11}) = 1\text{kHz} \sim 50\text{kHz} (12\text{kHz usual})$	
	$f_{zfb} = 1 / (2 \times \pi \times C_{FB2} \times R_{FB21}) = 1\text{kHz} \sim 50\text{kHz} (12\text{kHz usual})$	

### Circuit 6 and Circuit 9

L1, L2 :	47 $\mu$ H (CDRH5D28, SUMIDA)	: XC9501B091A
	22 $\mu$ H (CDRH5D28, SUMIDA)	: XC9501B092A
	15 $\mu$ H (CDRH5D28, SUMIDA)	: XC9501B093A
	10 $\mu$ H (CDRH5D28, SUMIDA)	: XC9501B095A
SD1, SD2:	MA2Q737 (Schottky diode, MATSUSHITA)	
CL1, CL2 :	16MCE476MD2 (Tantalum, NIHON CHEMICON)	
C <sub>IN</sub> :	16MCE476MD2 (Tantalum, NIHON CHEMICON)	
N-ch MOSFET1 :	XP161A1355P (TOREX)	

### Circuit 5 and Circuit 8

L1, L2 :	22 $\mu$ H (CDRH5D28, SUMIDA)	
SD1, SD2 :	MA2Q737 (Schottky diode, MATSUSHITA)	
CL1, CL2 :	16MCE476MD2 (Tantalum, NIHON CHEMICON)	
C <sub>IN</sub> :	16MCE476MD2 (Tantalum, NIHON CHEMICON)	
N-ch MOSFET1 :	XP161A1355P (TOREX)	

## NOTES ON USE

### 1. PWM/PFM Automatic Switching

If PWM/PFM automatic switching control is selected and the step-up ratio is low (e.g., from 4.5 V to 5.0 V), the control mode remains in PFM setting over the whole load range, since the duty ratio under continuous-duty condition is smaller than the PFM duty ratio of the XC9501 series. The output voltage's ripple voltage becomes substantially high under heavy load conditions, with the XC9501 series appearing to be producing an abnormal oscillation. If this operation becomes a concern, set pins PWM to High to set the control mode to PWM setting. For use under the above-mentioned condition, measured data of PWM/PFM automatic switching control shown on the data sheets are available up to I<sub>OUT</sub> = 100 mA.

### 2. Ratings

Use the XC9501 series and peripheral components within the limits of their ratings.

## TYPICAL PERFORMANCE CHARACTERISTICS

### (1) Output Voltage vs. Output Current

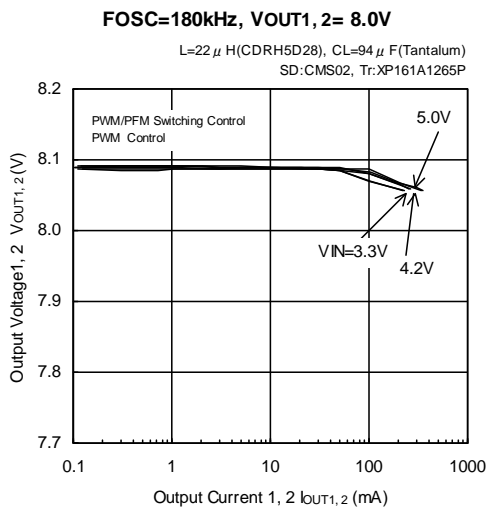
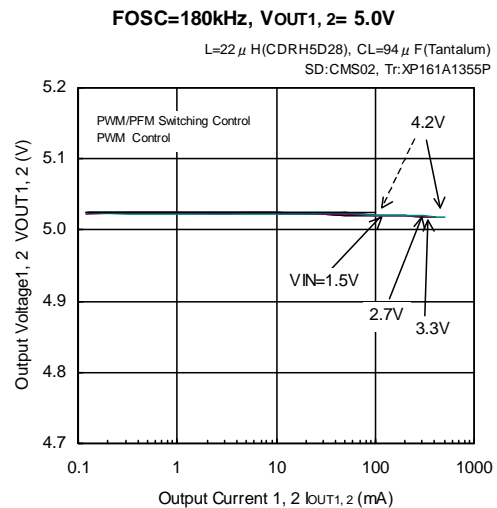
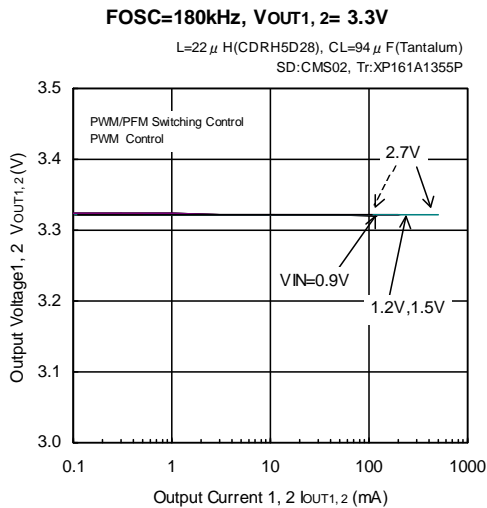
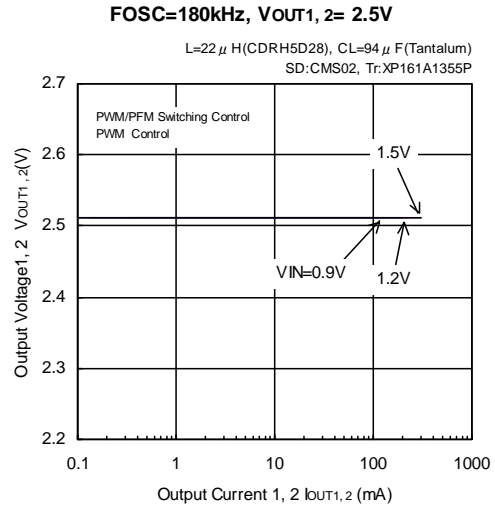
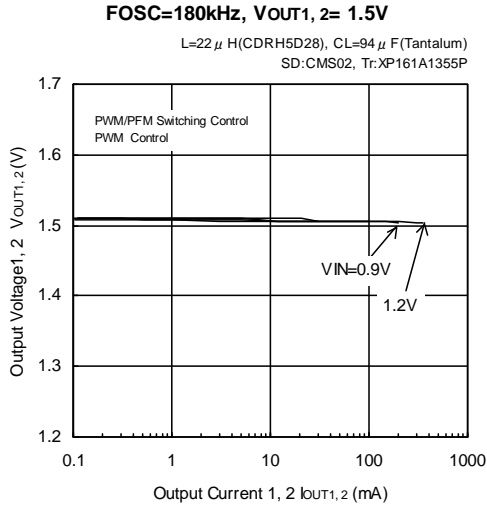

Dotted Arrowhead -----> PWM/PFM Switching Control

## ■ TYPICAL PERFORMANCE CHARACTERISTICS (Continued)

(1) Output Voltage vs. Output Current (Continued)

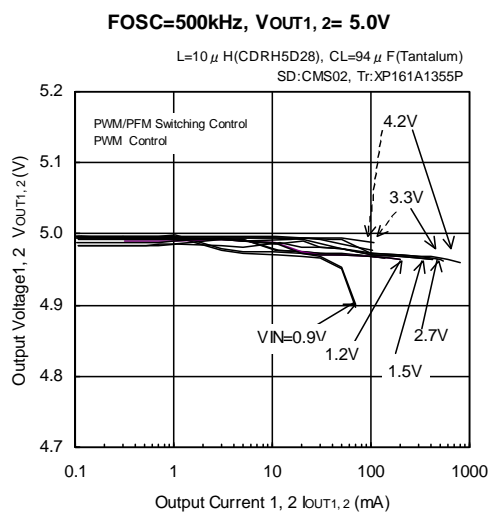
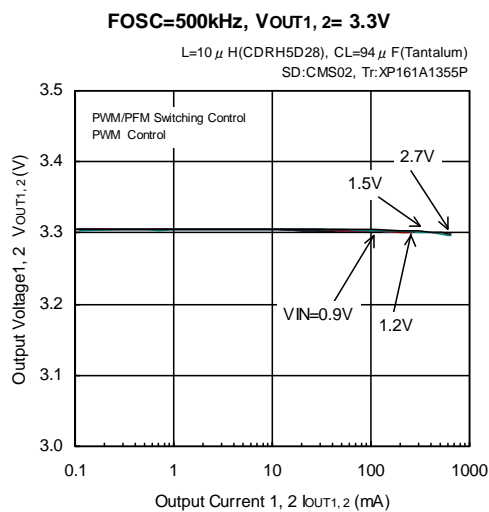
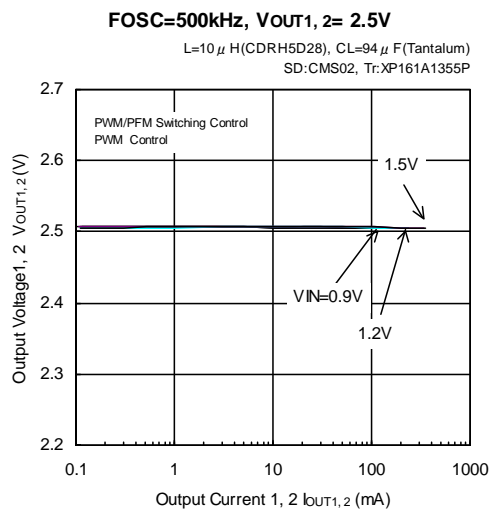
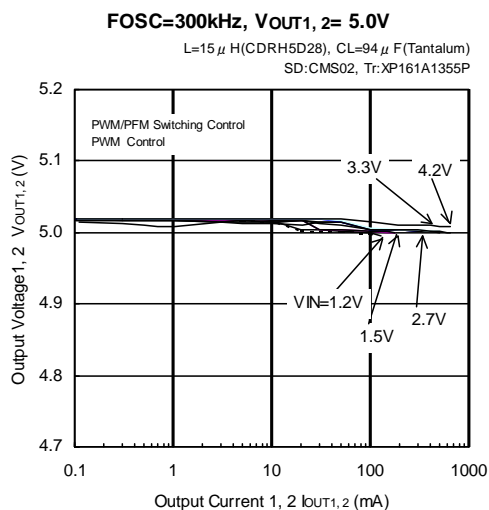
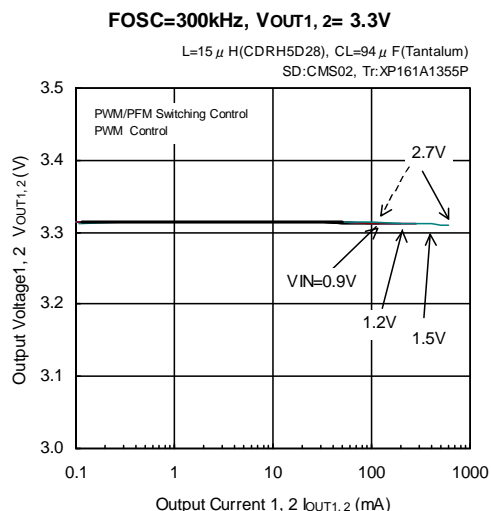
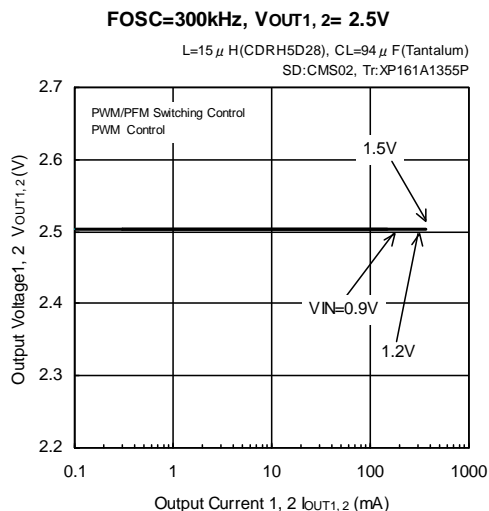

Dotted Arrowhead -----> PWM/PFM Switching Control

## TYPICAL PERFORMANCE CHARACTERISTICS (Continued)

### (2) Efficiency vs. Output Current

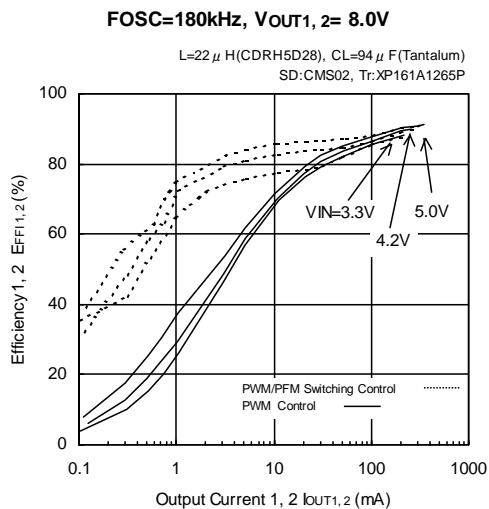
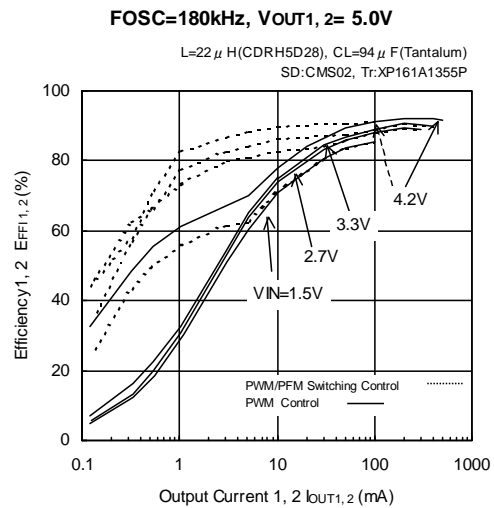
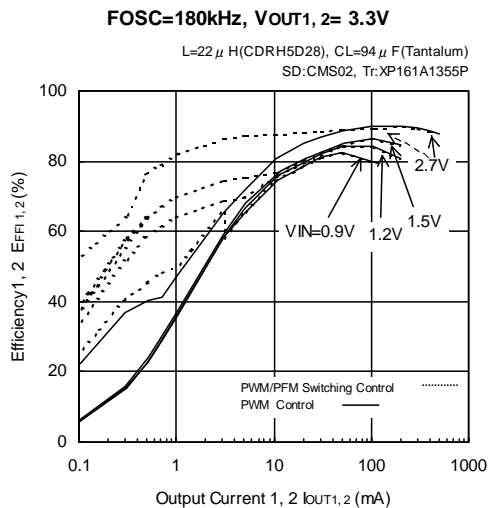
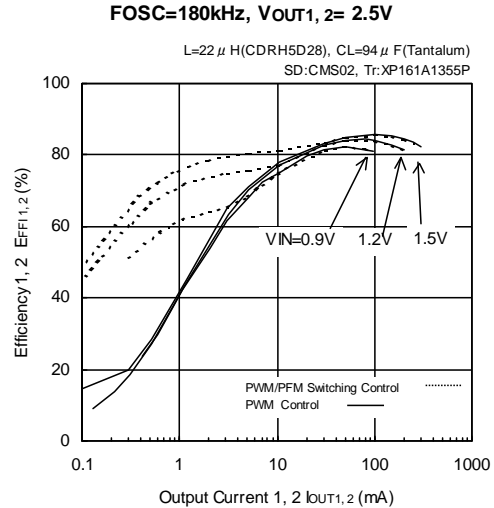
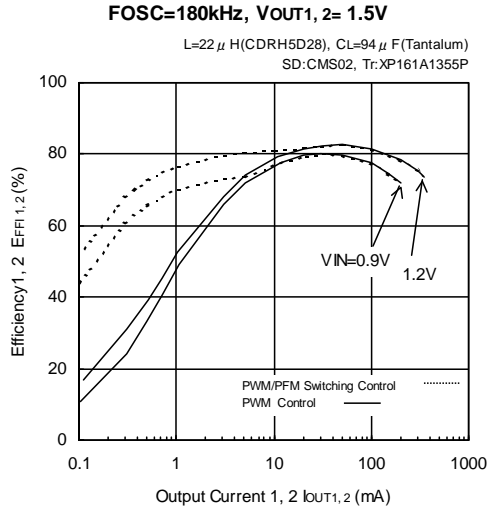

Dotted Arrowhead -----> PWM/PFM Switching Control



## ■ TYPICAL PERFORMANCE CHARACTERISTICS (Continued)

### (2) Efficiency vs. Output Current (Continued)

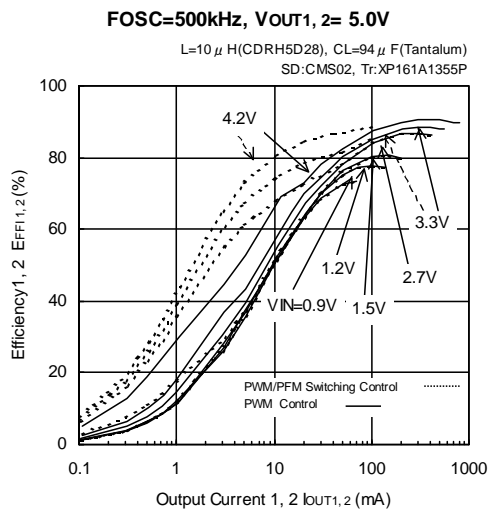
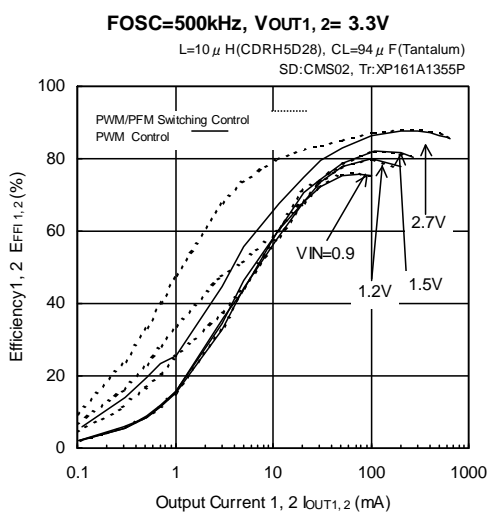
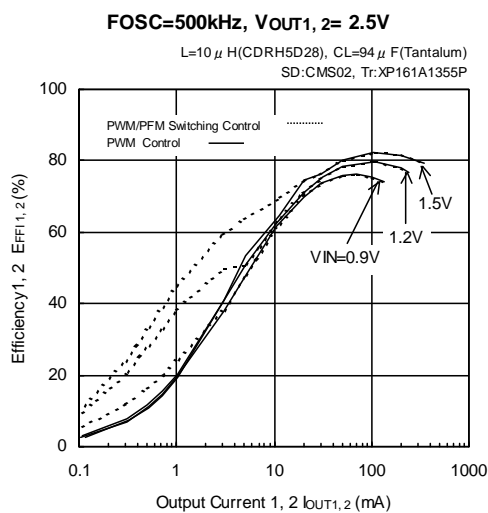
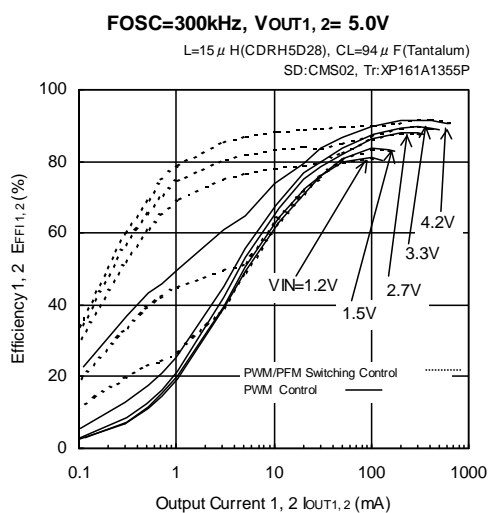
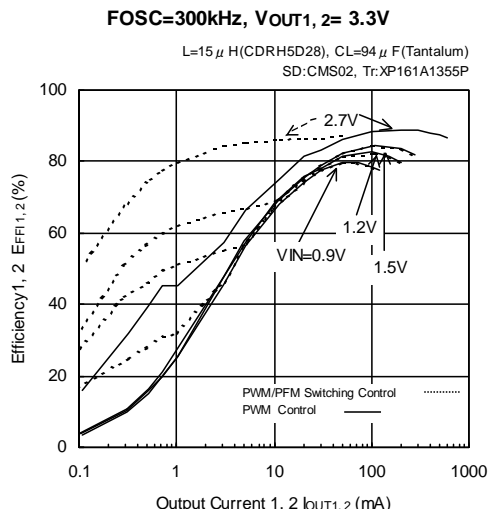
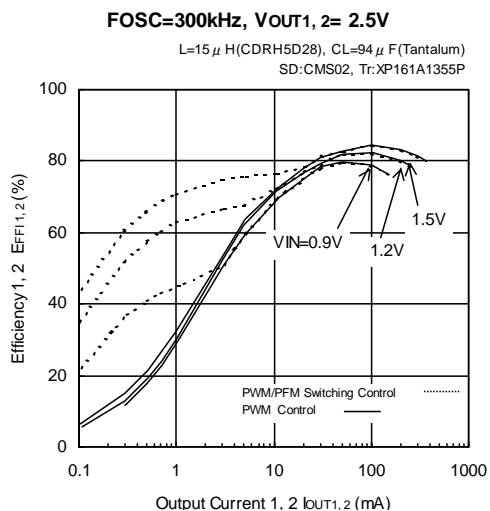

Dotted Arrowhead -----> PWM/PFM Switching Control

## TYPICAL PERFORMANCE CHARACTERISTICS (Continued)

### (3) Ripple Voltage vs. Output Current

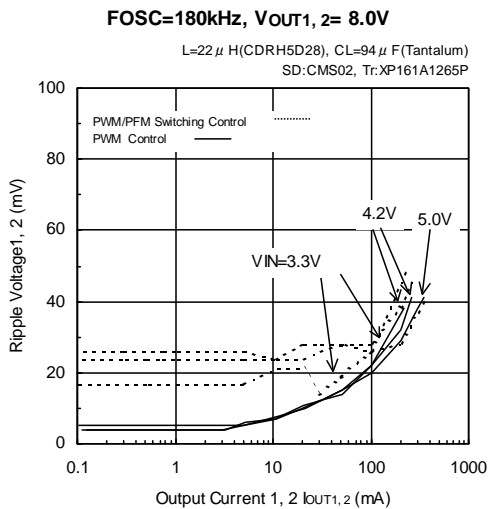
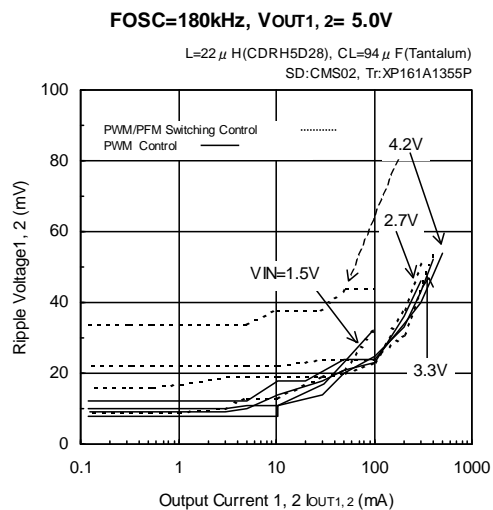
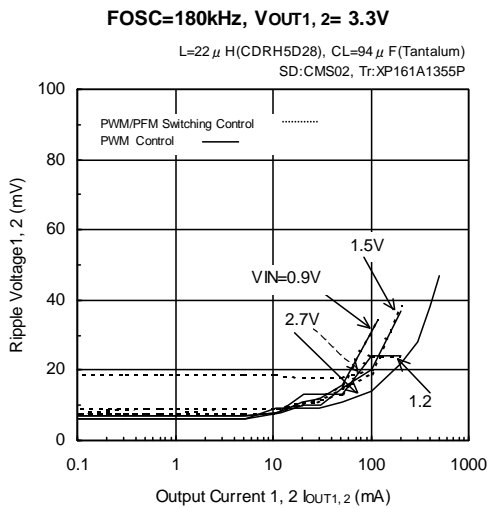
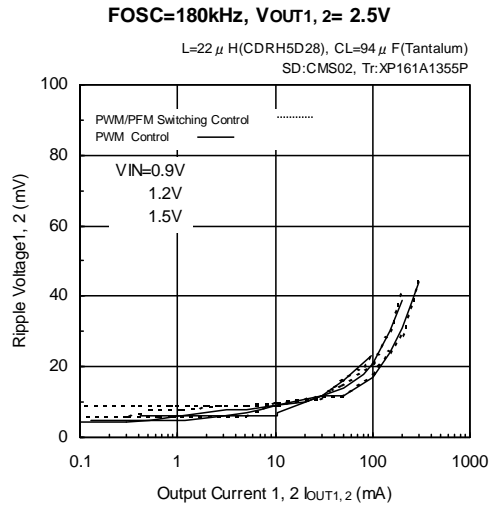
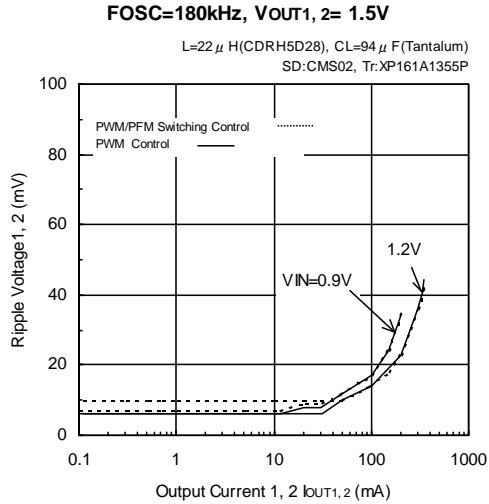

Dotted Arrowhead -----> PWM/PFM Switching Control

## ■ TYPICAL PERFORMANCE CHARACTERISTICS (Continued)

### (3) Ripple Voltage vs. Output Current (Continued)

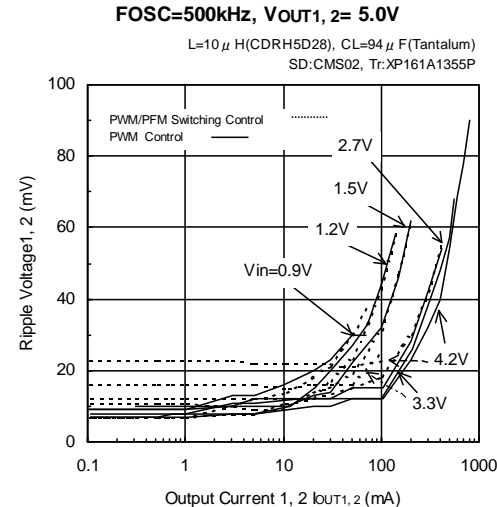
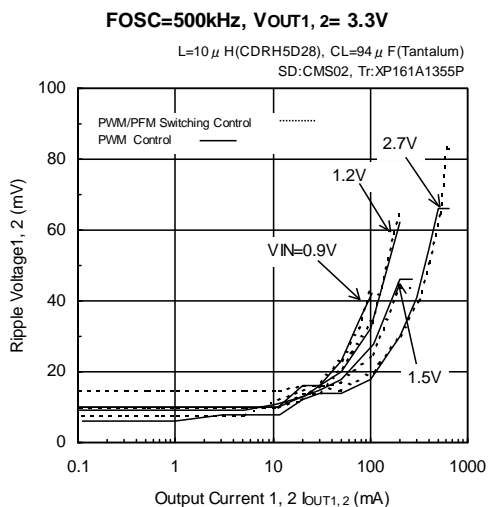
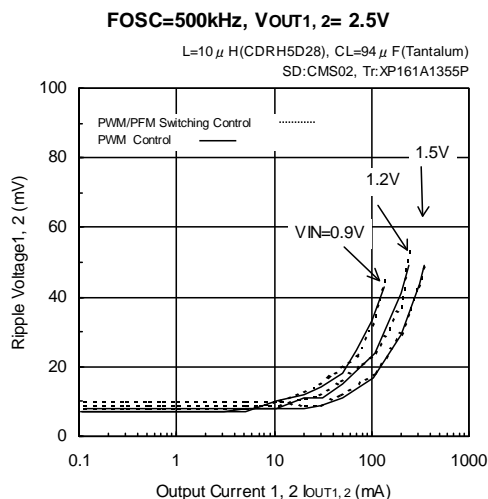
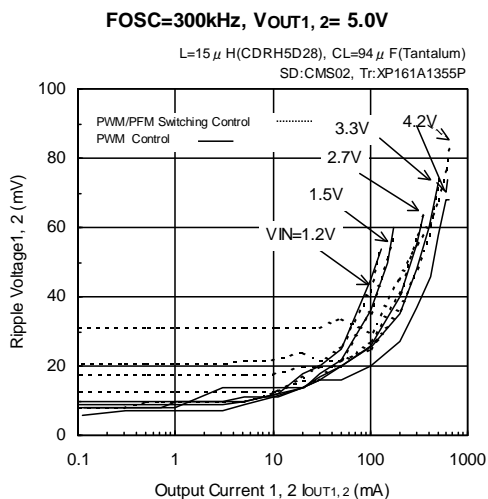
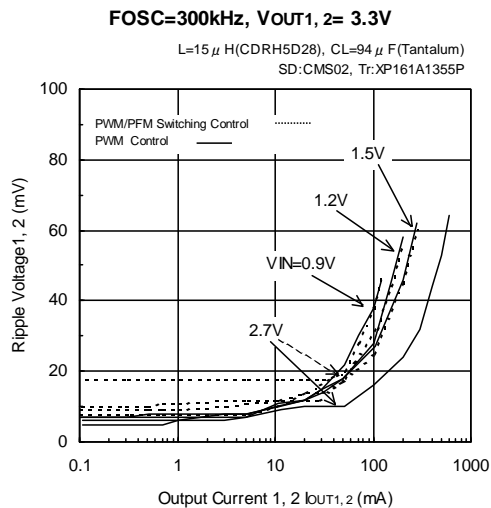
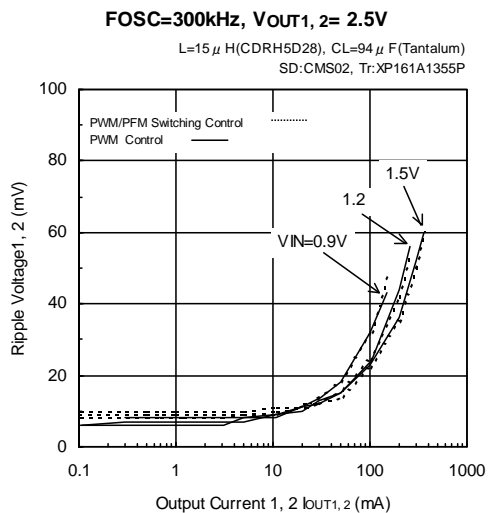

## TYPICAL PERFORMANCE CHARACTERISTICS (Continued)

(4) Supply Current vs. Supply Voltage

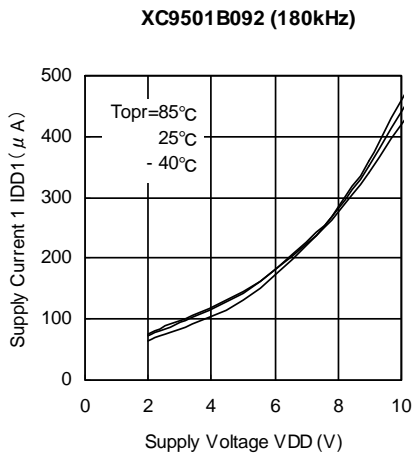

(5) Supply Current 1-1 vs. Supply Voltage

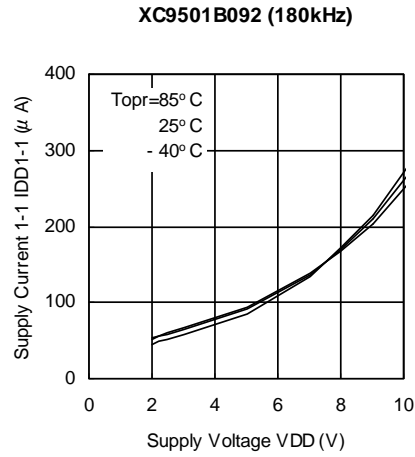

(6) Supply Current 1-2 vs. Supply Voltage

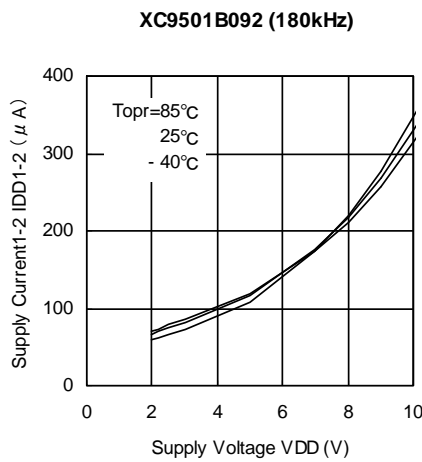

(7) Supply Current 2 vs. Supply Voltage

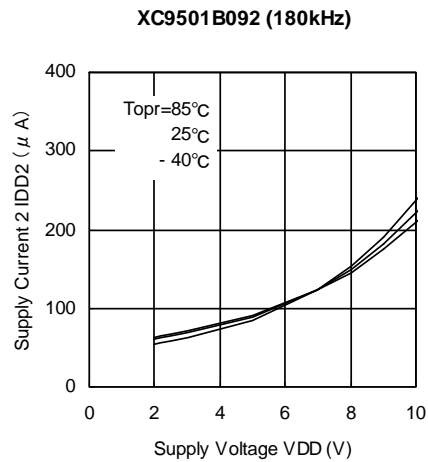

(8) Stand-by Current vs. Supply Voltage

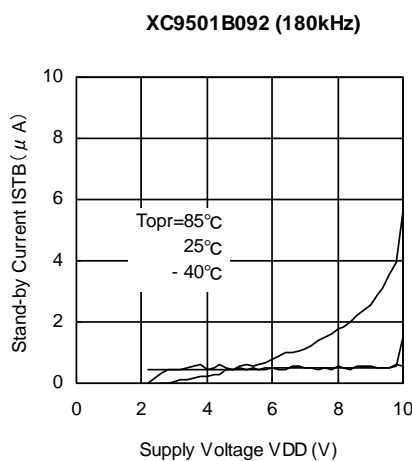

(9) Oscillation Frequency vs. Supply Voltage

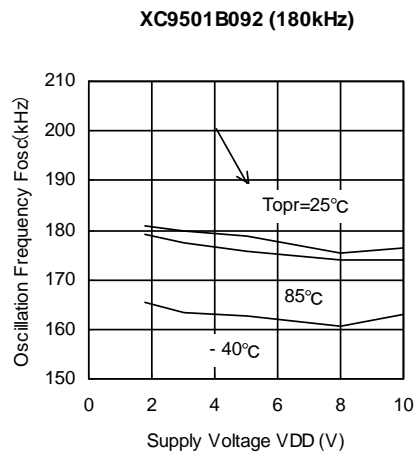

## ■ TYPICAL PERFORMANCE CHARACTERISTICS (Continued)

(10) PWM1, 2 'H' 'L' Voltage vs. Supply Voltage

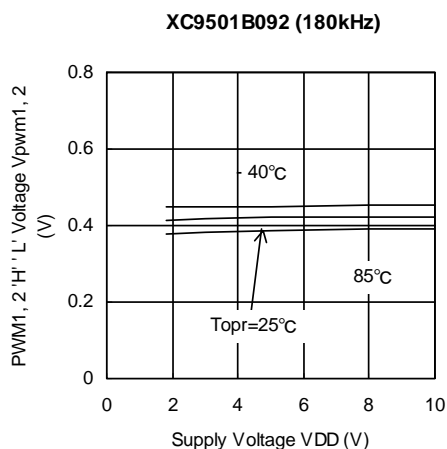

(11) EN1, 2 'H' 'L' Voltage vs. Supply Voltage

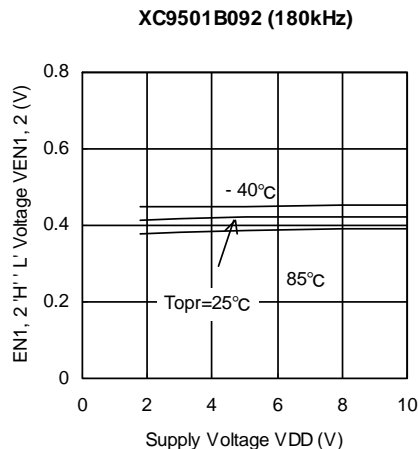

(12) Maximum Duty Ratio1, 2 vs. Supply Voltage

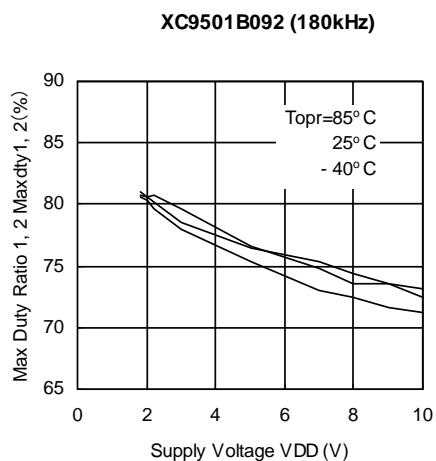

(13) Soft-start Time1, 2 vs. Supply Voltage

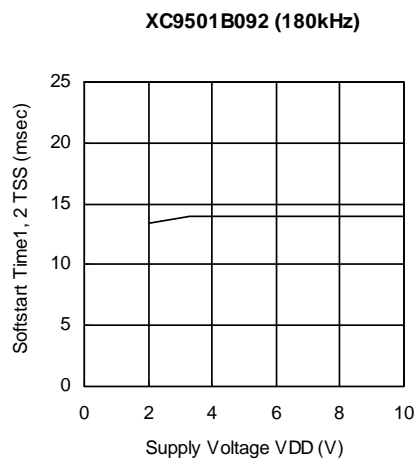

(14) EXT1, 2 High ON Resistance vs. Supply Voltage

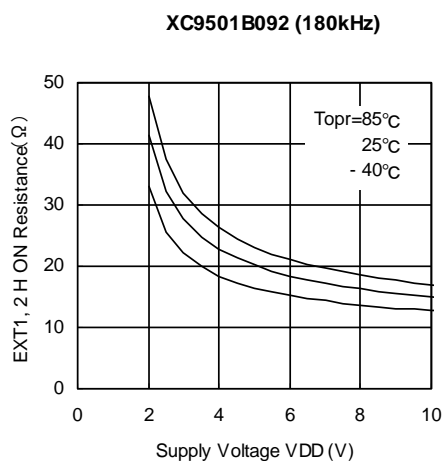

(15) EXT1, 2 Low ON Resistance vs. Supply Voltage

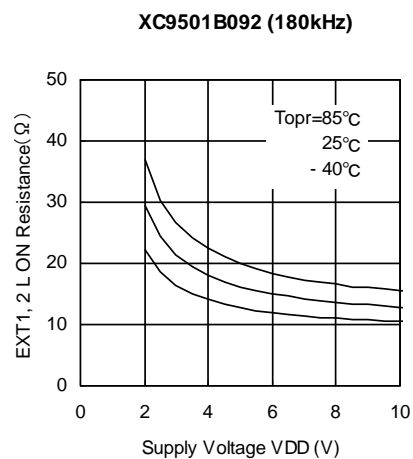

## TYPICAL PERFORMANCE CHARACTERISTICS (Continued)

(16) Operation Start Voltage vs. Ambient Temperature

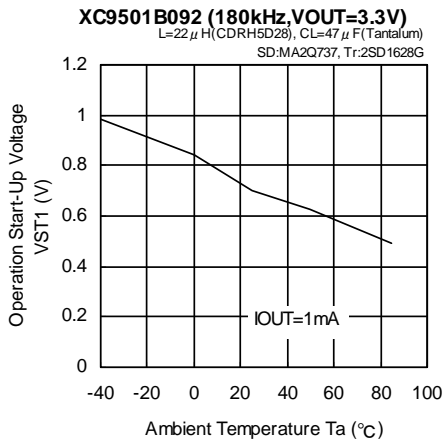

(17) Operation Retention Voltage vs. Ambient Temperature

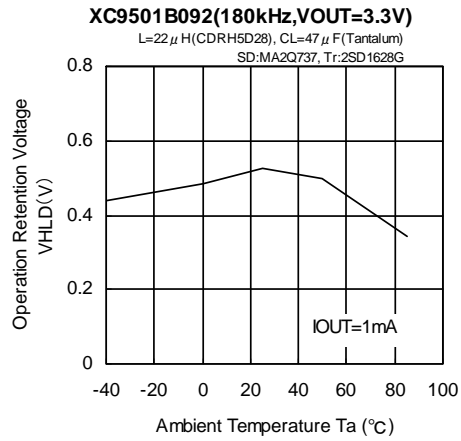

(18) Oscillation Start Voltage vs. Ambient Temperature

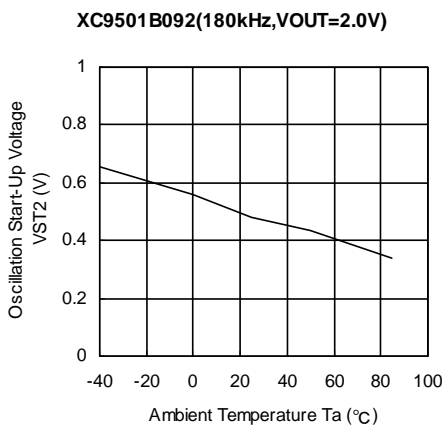

(19) PFM Duty Ratio 1, 2 vs. Supply Voltage

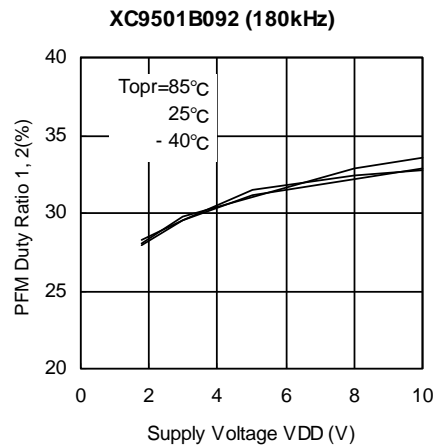

(20) Output Voltage vs. Ambient Temperature

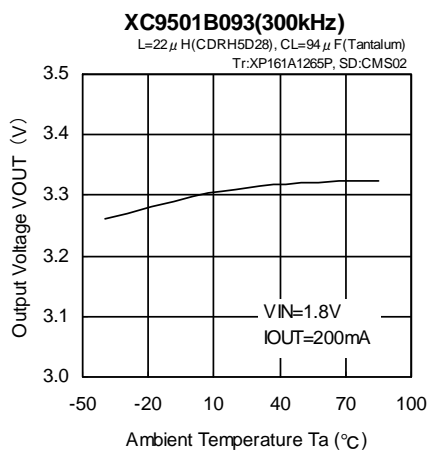

## ■ TYPICAL PERFORMANCE CHARACTERISTICS (Continued)

### (21) Load Transient Response (Continued)

<  $V_{OUT1,2} = 3.3V$ ,  $V_{IN} = 2.0V$ ,  $I_{OUT1,2} = 100\mu A \leftrightarrow 100mA$  >

#### ● PWM Control

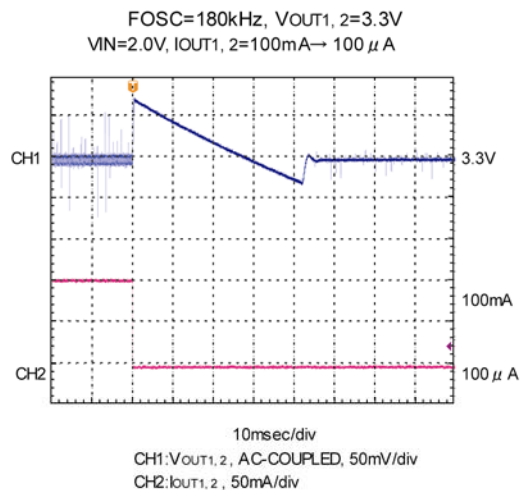
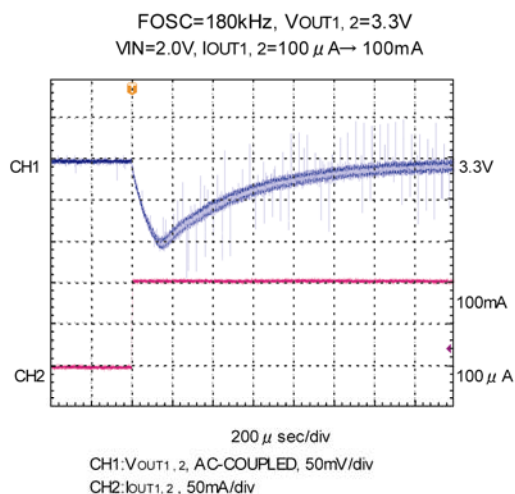

#### ● PWM/PFM Switching Control

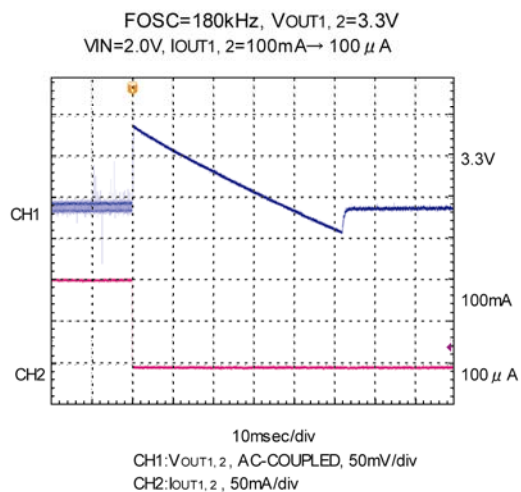
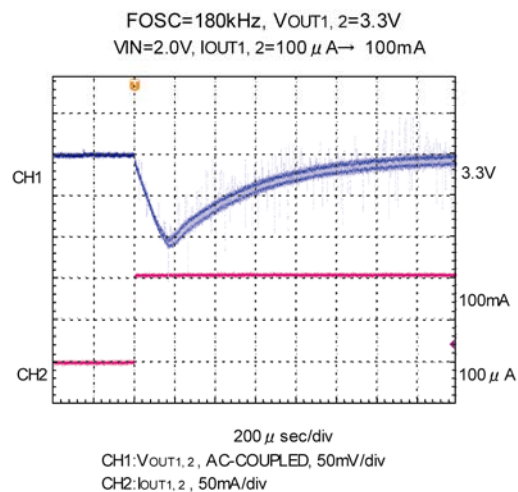

## TYPICAL PERFORMANCE CHARACTERISTICS (Continued)

### (21) Load Transient Response (Continued)

<  $V_{OUT1,2} = 3.3V$ ,  $V_{IN} = 2.0V$ ,  $I_{OUT1,2} = 10mA \leftrightarrow 100mA$  >

#### ● PWM Control

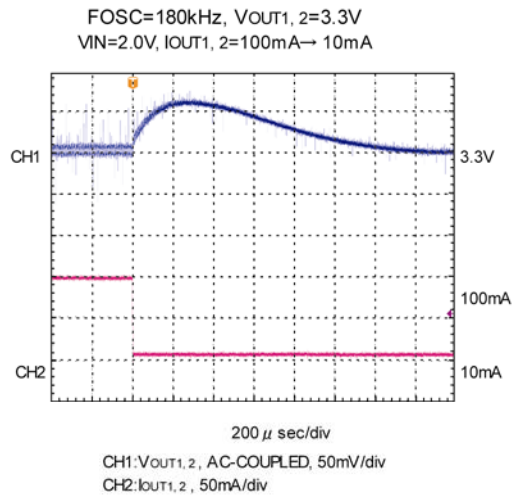
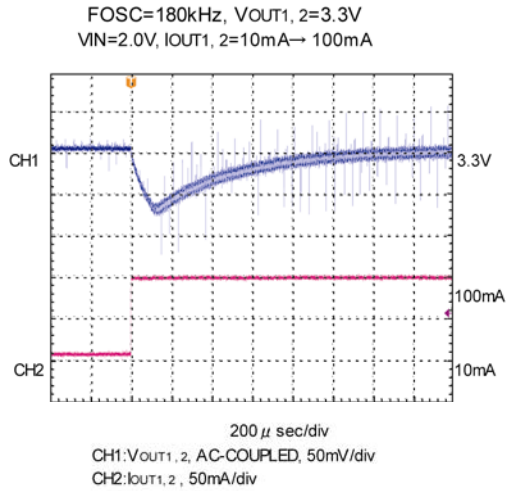

#### ● PWM/PFM Switching Control

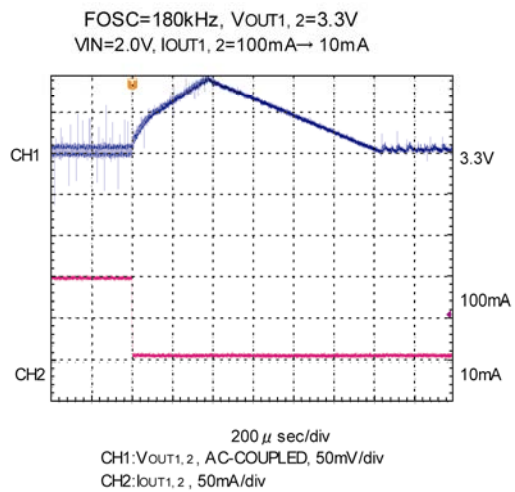
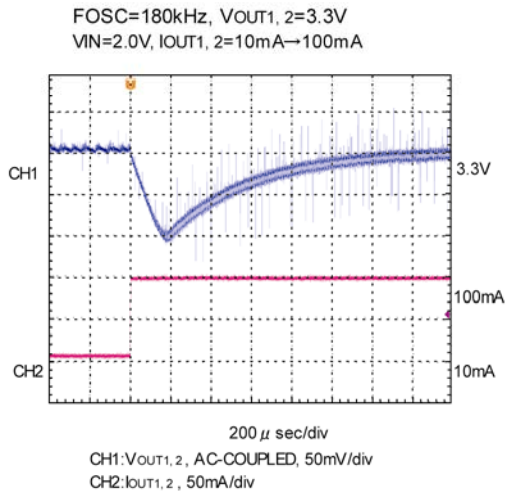



## ■ TYPICAL PERFORMANCE CHARACTERISTICS (Continued)

### (21) Load Transient Response (Continued)

< PWM Controlled  $\leftrightarrow$  PWM / PFM Switching Controlled >

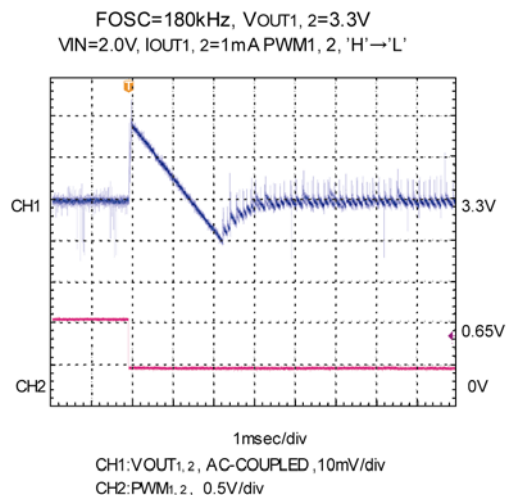
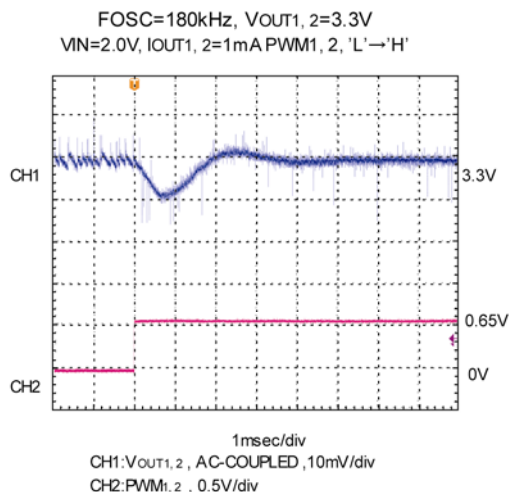

### ● Soft-Start Wave Form

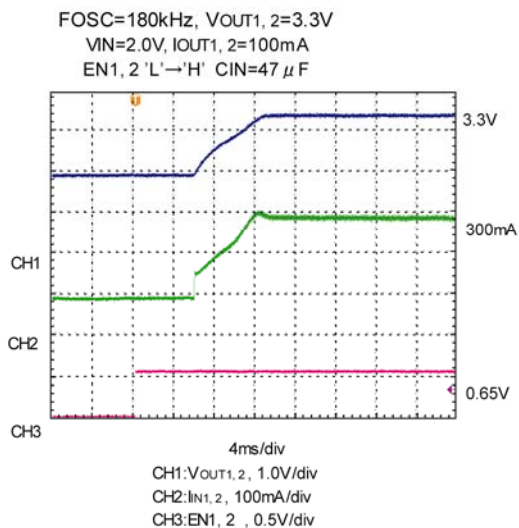

\*CH1: EN2=GND when measurement  
CH2: EN1=GND when measurement

## PACKAGING INFORMATION

### MSOP-10

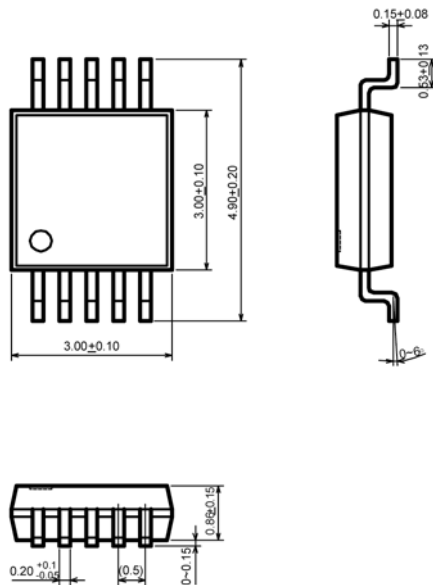

### USP-10

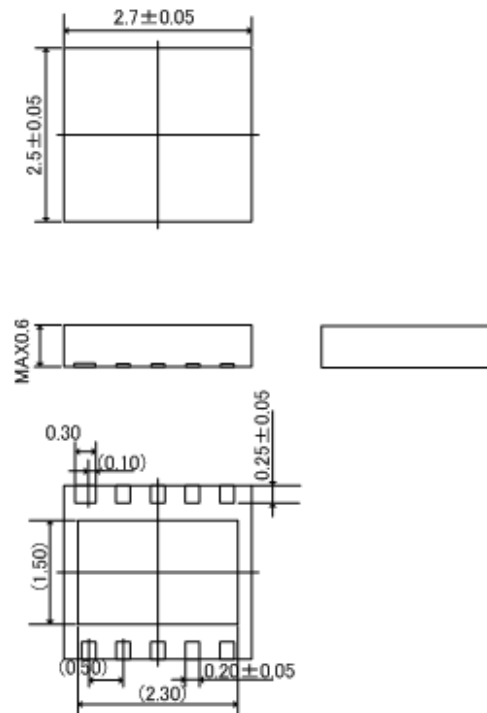

## MARKING RULE

### MSOP-10, USP-10

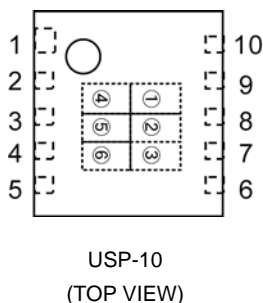
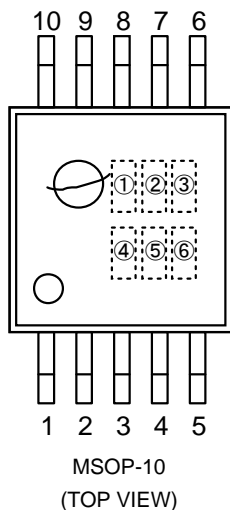

① represents product series

MARK	PRODUCT SERIES
2	XC9501B09xxx

② represents type of DC/DC Controller

MARK	PRODUCT SERIES
B	XC9501B09xxx

③, ④ represents FB voltage

MARK		VOLTAGE (V)	PRODUCT SERIES
③	④		
0	9	0.9	XC9501B09xxx

⑤ represents oscillation frequency

MARK	OSCILLATION FREQUENCY (kHz)	PRODUCT SERIES
1	100	XC9501B091xx
2	180	XC9501B092xx
3	300	XC9501B093xx
5	500	XC9501B095xx

⑥ represents production lot number

0 to 9, A to Z repeated (G, I, J, O, Q, W excluded)

Note: No character inversion used

1. The products and product specifications contained herein are subject to change without notice to improve performance characteristics. Consult us, or our representatives before use, to confirm that the information in this datasheet is up to date.
2. We assume no responsibility for any infringement of patents, patent rights, or other rights arising from the use of any information and circuitry in this datasheet.
3. Please ensure suitable shipping controls (including fail-safe designs and aging protection) are in force for equipment employing products listed in this datasheet.
4. The products in this datasheet are not developed, designed, or approved for use with such equipment whose failure or malfunction can be reasonably expected to directly endanger the life of, or cause significant injury to, the user.  
(e.g. Atomic energy; aerospace; transport; combustion and associated safety equipment thereof.)
5. Please use the products listed in this datasheet within the specified ranges.  
Should you wish to use the products under conditions exceeding the specifications, please consult us or our representatives.
6. We assume no responsibility for damage or loss due to abnormal use.
7. All rights reserved. No part of this datasheet may be copied or reproduced without the prior permission of TOREX SEMICONDUCTOR LTD.

**TOREX SEMICONDUCTOR LTD.**