

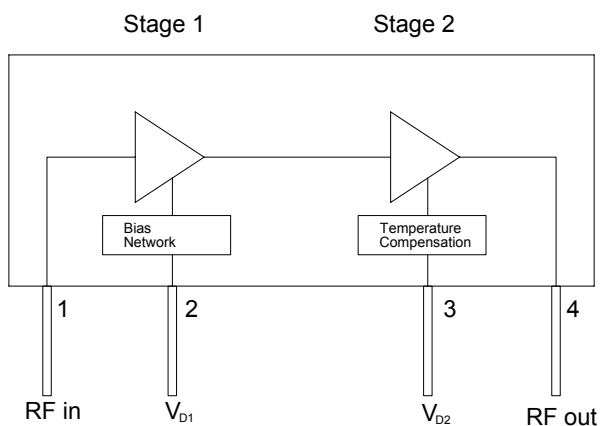

Product Description

Sirenza Microdevices' **XD010-42S-D4F** 8W power module is a robust 2-stage Class A amplifier module for use in the driver stages of linear RF power amplifiers of cellular base stations. The power transistors are fabricated using Sirenza's latest, high performance LDMOS process. This unit operates from a single voltage and has internal temperature compensation of the bias voltage to ensure stable performance over the full temperature range. It is internally matched to 50 ohms.

Functional Block Diagram



Case Flange = Ground

XD010-42S-D4F

**869-894 MHz Class A
8 W Power Amplifier Module**

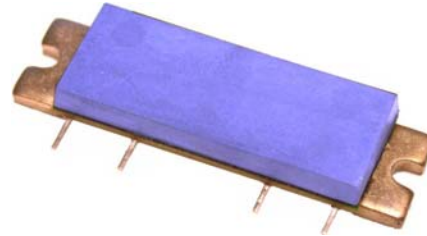

Product Features

- 50 Ω RF impedance
- 8W Output P1dB Typical
- Single Supply Operation : Nominally 28V
- High Gain: 30 dB at 880 MHz
- Advanced, XeMOS II LDMOS FETS
- Temperature Compensation

Applications

- Base Station PA driver
- Repeater
- CDMA
- GSM / EDGE

Key Specifications

Symbol	Parameter	Unit	Min.	Typ.	Max.
Frequency	Frequency of Operation	MHz	869		894
P _{1dB}	Output Power at 1dB Compression, 880 MHz	W	7	8	
Gain	Gain at 1W Output Power (CW)	dB	28	30	
Gain Flatness	Over Frequency at 1W Output (CW)	dB		0.4	1
IRL	Input Return Loss at 1W Output (CW) (50 Ω Ref)	dB	14	20	
Efficiency	Drain Efficiency at 8W CW Output	%	22	24	
	Drain Efficiency at 1W CDMA (Single Carrier IS-95)	%		3.5	
Linearity	ACPR at 1W CDMA Output (Single Carrier IS-95, 9 Ch Fwd, Offset=750KHz, ACPR Integrated Bandwidth)	dB		-50	
	ALT-1 at 1W CDMA (Single Carrier IS-95, 9 Ch Fwd, Offset=1980KHz, ACPR Integrated Bandwidth)	dB		-75	
	3rd Order IMD at 8W PEP (Two Tone 1MHz Spacing)	dB	-28	-32	
	3rd Order IMD at 1W PEP (Two Tone 1MHz Spacing)	dBc	-40	-50	
Delay	Signal Delay from Pin 1 to Pin 4	nS		3.9	
Phase Linearity	Deviation from Linear Phase (Peak to Peak)	Deg		0.5	
R _{TH, J1}	Thermal Resistance Stage 1 (Junction to Case)	$^{\circ}$ C/W		11	

Test Conditions: Z_{in} = Z_{out} = 50 Ω , V_{DD} = 28.0V, I_{DQ1} = 230mA, I_{DQ2} = 700mA, T_{Flange} = 25 $^{\circ}$ C

Quality Specifications

Parameter		Unit	Typical
ESD Rating	Human Body Model, JEDEC Document - JESD22-A114-B	V	8000
MTTF	85°C Leadframe, 200°C Channel	Hours	1.2 X 10 ⁶

Pin Description

Pin #	Function	Description
1	RF Input	Module RF input. This pin is internally connected to DC ground. Do not apply DC voltages to the RF leads. Care must be taken to protect against video transients that may damage the active devices.
2	V _{D1}	This is the drain voltage for the first stage. Nominally +28Vdc
3	V _{D2}	This is the drain voltage for the 2 nd stage of the amplifier module. The 2 nd stage gate bias is temperature compensated to maintain constant quiescent drain current over the operating temperature range. See Note 1.
4	RF Output	Module RF output. This pin is internally connected to DC ground. Do not apply DC voltages to the RF leads. Care must be taken to protect against video transients that may damage the active devices.
Flange	Gnd	Exposed area on the bottom side of the package needs to be mechanically attached to the ground plane of the board for optimum thermal and RF performance. See mounting instructions in application note AN-060 on Sirenza's web site.

Simplified Device Schematic

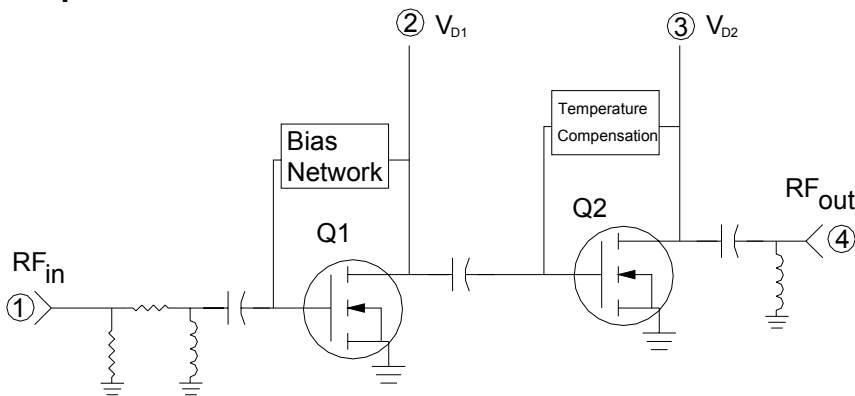

Case Flange = Ground

Absolute Maximum Ratings

Parameters	Value	Unit
1 st Stage Bias Voltage (V _{D1})	35	V
2 nd Stage Bias Voltage (V _{D2})	35	V
RF Input Power	+20	dBm
Load Impedance for Continuous Operation Without Damage	5:1	VSWR
Output Device Channel Temperature	+200	°C
Base Plate Temperature: Operating with no RF Present	+90	°C
Operating Temperature Range	-20 to +90	°C
Storage Temperature Range	-40 to +100	°C

Operation of this device beyond any one of these limits may cause permanent damage. For reliable continuous operation see typical setup values specified in the table on page one.



Caution: ESD Sensitive

Appropriate precaution in handling, packaging and testing devices must be observed.

Note 1:

The internal generated gate voltage is thermally compensated to maintain constant quiescent current over the temperature range listed in the data sheet. No compensation is provided for gain changes with temperature. This can only be provided with AGC external to the module.

Note 2:

Internal RF decoupling is included on all bias leads. No additional bypass elements are required, however some applications may require energy storage on the drain leads to accommodate time-varying waveforms.

Note 3:

This module was designed to have its leads hand soldered to an adjacent PCB. The maximum soldering iron tip temperature should not exceed 700° C, and the soldering iron tip should not be in direct contact with the lead for longer than 10 seconds. Refer to app note AN054 (www.sirenza.com) for further installation instructions.

Typical Performance Curves

Gain, IMD, ACP, ALT1 vs. Output Power
 Freq=881 MHz, Vdd=28V, T_{Flange}=25°C, IS-95
 ADJ BW=30KHz @ 750 KHz spacing
 ALT1 BW=30KHz @1980 KHz spacing
 IMD @ 1 MHz spacing

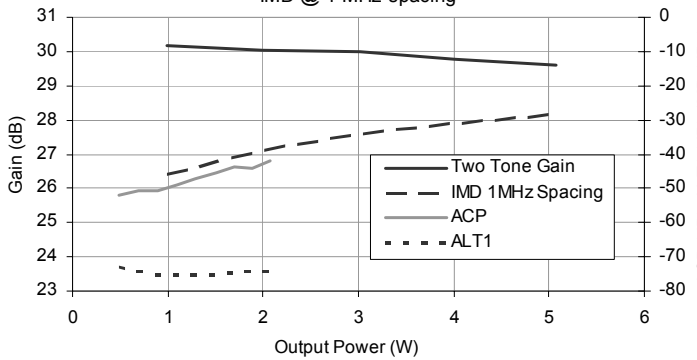

Efficiency and Idd vs. Output Power and Temperature
 Freq=881 MHz, Vdd=28 V, T_{Flange}=-20°C, 25°C, 90°C

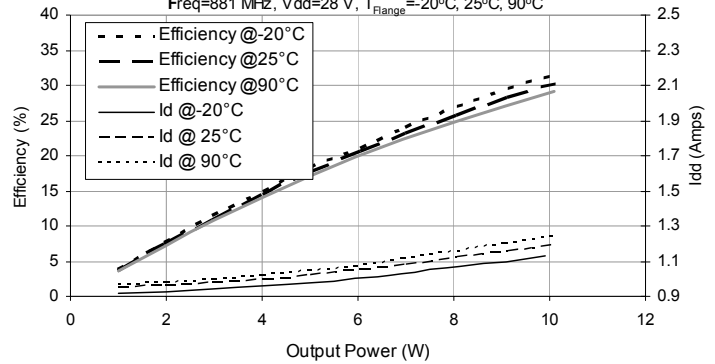

Two Tone IMD, ACP, ALT1 vs. Frequency
 Output Power=1 Watt, Vdd=28 V, T_{Flange}=25°C IS95 standard,
 channel BW= 1.23 MHz, ADJ BW= 30 KHz@ 750 KHz spacing.
 ALT1 BW= 30 KHz@1980 KHz spacing. IMD@1 MHz spacing.

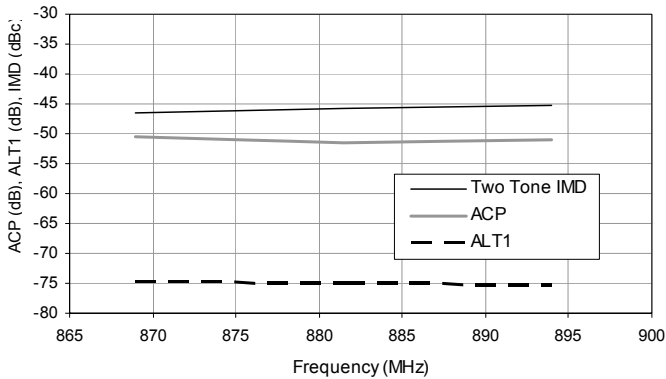

Gain and IMD vs. Output Power and Temperature
 Freq=881 MHz, Vdd=28 V, T_{Flange}=-20°C, 25°C, 90°C

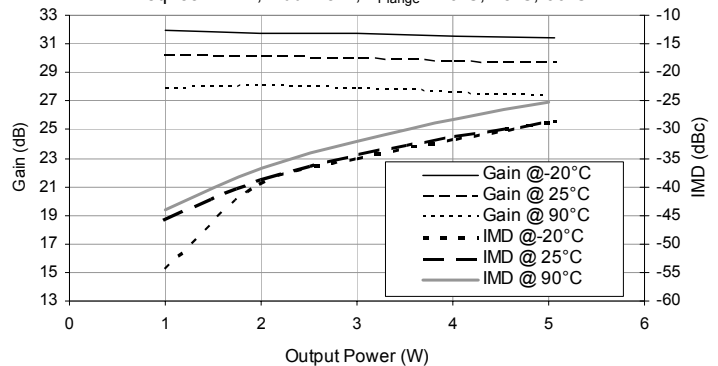

Gain and IMDs vs. Output Power and Voltage
 Freq=881 and 882 MHz, Vdd=24 V, 28 V, 32 V
 T_{Flange}=25°C

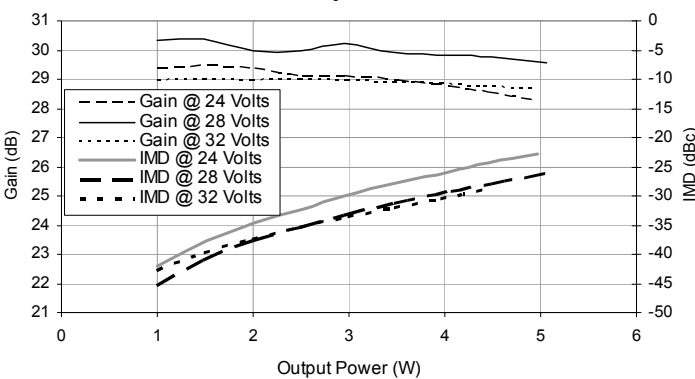

Gain and Input Return Loss vs. Frequency
 Output Power=1 Watt, Vdd=28 V, T_{Flange}=25°C

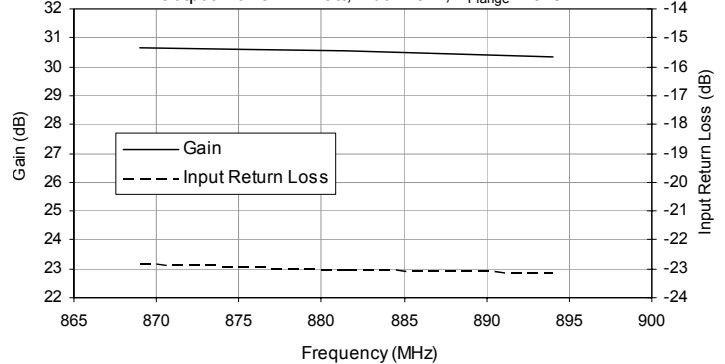

Test Board Schematic with module connections shown

Test Board Bill of Materials

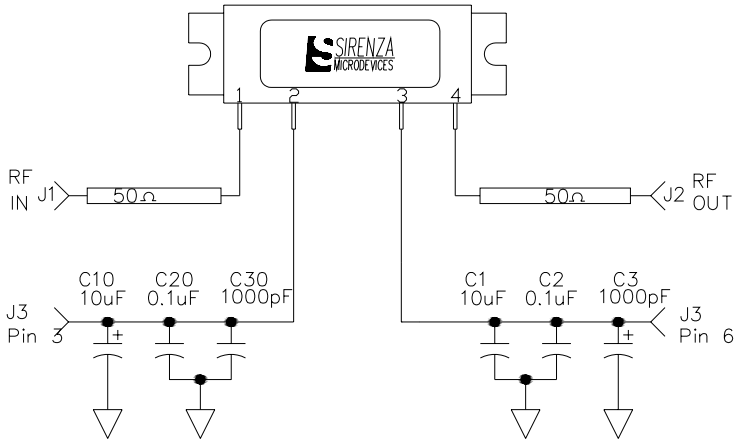

Component	Description	Manufacturer
PCB	Rogers 4350, $\epsilon_r=3.5$ Thickness=30mils	Rogers
J1, J2	SMA, RF, Panel Mount Tab W / Flange	Johnson
J3	MTA Post Header, 6 Pin, Rectangle, Polarized, Surface Mount	AMP
C1, C10	Cap, 10 μ F, 35V, 10%, Tant, Elect, D	Kemet
C2, C20	Cap, 0.1 μ F, 100V, 10%, 1206	Johanson
C3, C30	Cap, 1000pF, 100V, 10%, 1206	Johanson
C25, C26	Cap, 68pF, 250V, 5%, 0603	ATC
C21, C22	Cap, 0.1 μ F, 100V, 10%, 0805	Panasonic
C23, C24	Cap, 1000pF, 100V, 10%, 0603	AVX
Mounting Screws	4-40 X 0.250"	Various

Test Board Layout

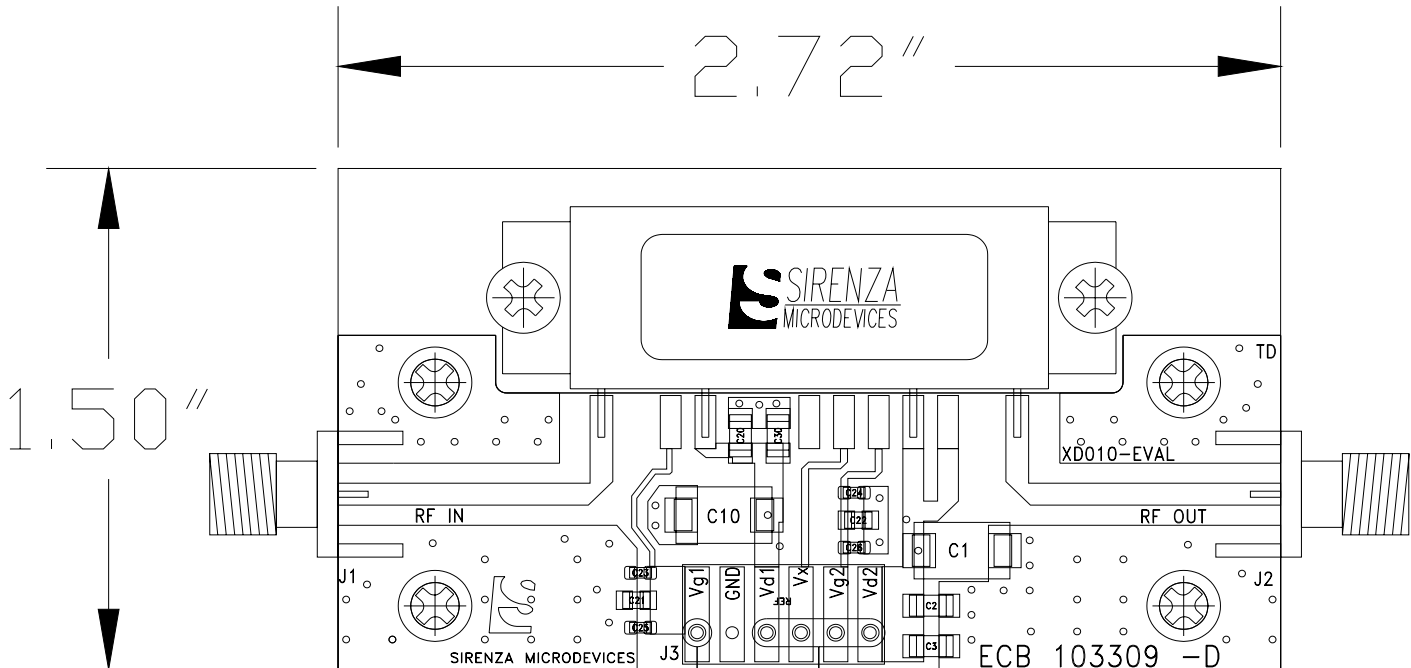

To receive Gerber files, DXF drawings, a detailed BOM, and assembly recommendations for the test board with fixture, contact applications support at support@sirenza.com. Data sheet for evaluation circuit (XD010-EVAL) available from Sirenza website.

Package Outline Drawing

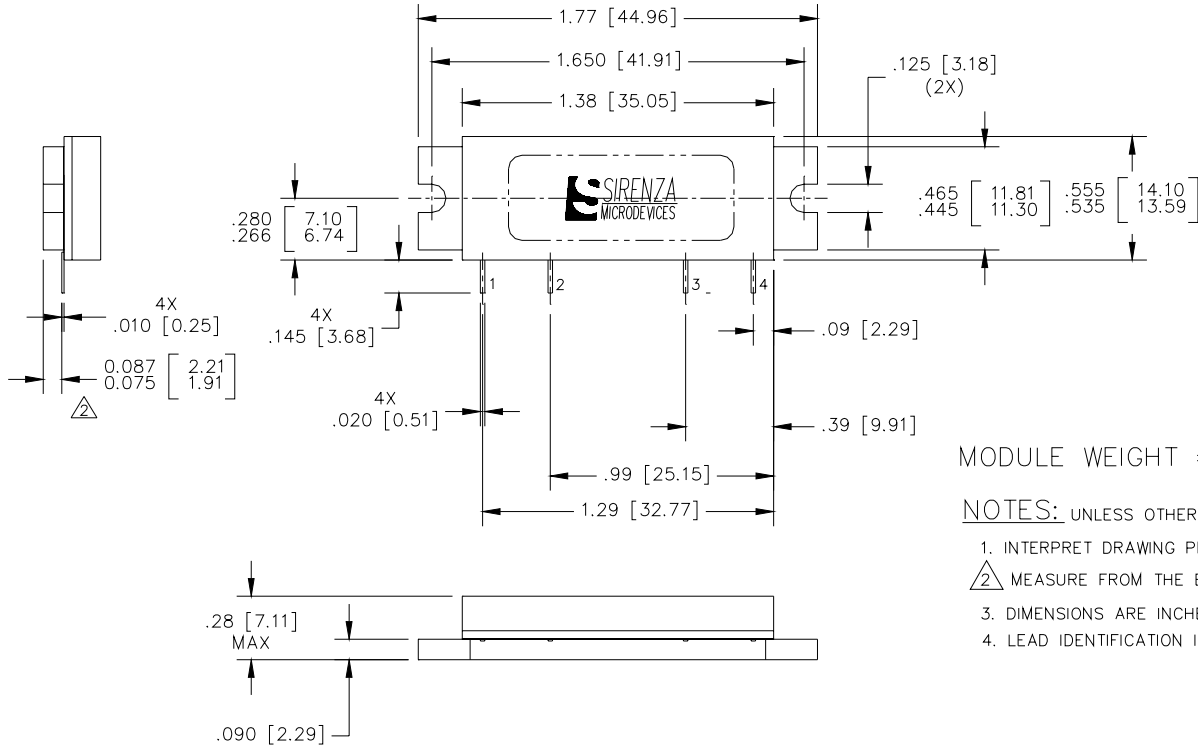

MODULE WEIGHT = 12gm Nominal

NOTES: UNLESS OTHERWISE SPECIFIED

1. INTERPRET DRAWING PER ANSI Y14.5.
2. MEASURE FROM THE BOTTOM OF THE LEADS.
3. DIMENSIONS ARE INCHES [MM].
4. LEAD IDENTIFICATION IS FOR REFERENCE ONLY.

Recommended PCB Cutout and Landing Pads for the D4F Package

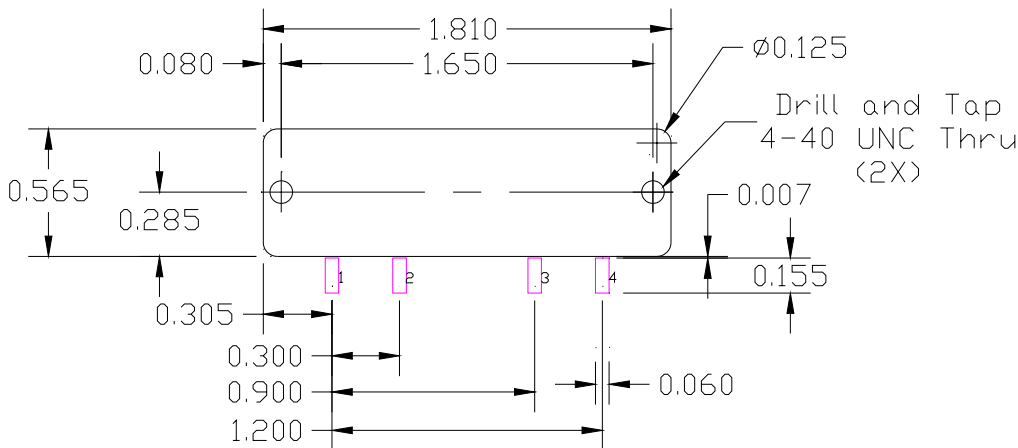

Note 3: Dimensions are in inches

Refer to Application note AN-060 "Installation Instructions for XD Module Series" for additional mounting info. App note available at www.sirenza.com