

SHARP®

ELECTRONIC CASH REGISTER

MODEL **XE-A212**

INSTRUCTION MANUAL



CAUTION:

The cash register should be securely fitted to the supporting platforms to avoid instability when the drawer is open.

CAUTION:

The socket-outlet shall be installed near the equipment and shall be easily accessible.

VORSICHT:

Die Netzsteckdose muß nahe dem Gerät angebracht und leicht zugänglich sein.

ATTENTION:

La prise de courant murale devra être installée à proximité de l'équipement et devra être facilement accessible.

AVISO:

El tomacorriente debe estar instalado cerca del equipo y debe quedar bien accesible.

VARNING:

Det matande vägguttaget skall placeras nära apparaten och vara lätt åtkomligt.

LET OP:

Het stopcontact dient in de buurt van de kassa en gemakkelijk toegankelijk te zijn.

CAUTION:

For a complete electrical disconnection pull out the mains plug.

VORSICHT:

Zur vollständigen elektrischen Trennung vom Netz den Netzstecker ziehen.

ATTENTION:

Pour obtenir une mise hors-circuit totale, débrancher la prise de courant secteur.

AVISO:

Para una desconexión eléctrica completa, desenchufar el enchufe de tomacorriente.

VARNING:

För att helt koppla från strömmen, dra ut stickproppen.

LET OP:

Trek de stekker uit het stopcontact indien u de stroom geheel wilt uitschakelen.

This equipment complies with the requirements of Directives 89/336/EEC and 73/23/EEC as amended by 93/68/EEC.

Dieses Gerät entspricht den Anforderungen der EG-Richtlinien 89/336/EWG und 73/23/EWG mit Änderung 93/68/EWG.

Ce matériel répond aux exigences contenues dans les directives 89/336/CEE et 73/23/CEE modifiées par la directive 93/68/CEE.

Dit apparaat voldoet aan de eisen van de richtlijnen 89/336/EEG en 73/23/EEG, gewijzigd door 93/68/EEG.

Dette udstyr overholder kravene i direktiv nr. 89/336/EEC og 73/23/EEC med tillæg nr. 93/68/EEC.

Quest' apparecchio è conforme ai requisiti delle direttive 89/336/EEC e 73/23/EEC, come emendata dalla direttiva 93/68/EEC.

Η εγκατάσταση αυτή ανταποκρίνεται στις απαιτήσεις των οδηγιών της Ευρωπαϊκής Ένωσης 89/336/ΕΟΚ και 73/23/ΕΟΚ, όπως οι κανονισμοί αυτοί συμπληρώθηκαν από την οδηγία 93/68/ΕΟΚ.

Este equipamento obedece às exigências das directivas 89/336/CEE e 73/23/CEE, na sua versão corrigida pela directiva 93/68/CEE.

Este aparato satisface las exigencias de las Directivas 89/336/CEE y 73/23/CEE, modificadas por medio de la 93/68/CEE.

Denna utrustning uppfyller kraven enligt riktlinjerna 89/336/EEC och 73/23/EEC så som komplette ras av 93/68/EEC.

Dette produktet oppfyller betingelsene i direktivene 89/336/EEC og 73/23/EEC i endringen 93/68/EEC.

Tämä laite täyttää direktiivien 89/336/EEC ja 73/23/EEC vaatimukset, joita on muutettu direktiivillä 93/68/EEC.

FOR CUSTOMERS IN U.K.

IMPORTANT

The wires in this mains lead are coloured in accordance with the following code:

| | |
|---------------|----------------|
| BLUE: | Neutral |
| BROWN: | Live |

As the colours of the wires in the mains lead of this apparatus may not correspond with the coloured markings identifying the terminals in your plug proceed as follows.

The wire which is coloured **BLUE** must be connected to the terminal which is marked with the letter **N** or coloured black.

The wire which is coloured **BROWN** must be connected to the terminal which is marked with the letter **L** or coloured red.

The apparatus must be protected by a 3A fuse in the mains plug or distribution board.

CAUTION: DO NOT CONNECT THE LIVE (BROWN) WIRE OR THE NEUTRAL (BLUE) WIRE TO THE EARTH TERMINAL OF YOUR 3-PIN MAINS PLUG.

Environment Protection

The device is supported by a battery. To dispose the battery safely to protect the environment, please note the following points:

- Take the used battery to your local waste depot, dealer or customer service centre for recycling.
- Do not throw the used battery into fire, into water or into the household waste!

Umweltschutz

Das Gerät wird durch eine Batterie gestützt. Um die Batterie sicher und umweltschonend zu entsorgen, beachten Sie bitte folgende Punkte:

- Bringen Sie die leere Batterie zu Ihrer örtlichen Mülldeponie, zum Händler oder zum Kundenservice-Zentrum zur Entsorgung.
- Werfen Sie die leere Batterie niemals ins Feuer, ins Wasser oder in den Hausmüll.

Protection de l'environnement

L'appareil est supporté sur pile. Afin de protéger l'environnement, nous vous recommandons de traiter la pile usagée la façon suivante:

- Apporter la pile usagée à votre centre de traitement des ordures ménagères le plus proche ou, à votre revendeur ou, au service après-vente, pour recyclement.
- Ne jamais jeter la pile usagée dans une source de chaleur, dans l'eau ou dans les vide-ordures.

Miljöskydd

Denna produkt nöddrivs av batteri.

Vid batteribyte skall följande iakttagas:

- Det förbrukade batteriet skall inlämnas till er lokala handlare eller till kommunal miljöstation för återinsamling.
- Kasta ej batteriet i vattnet eller i hushållssoporna. Batteriet får ej heller utsättas för öppen eld.

Bescherming van het milieu

Deze kassa gebruikt een batterij. Bescherm het milieu en gooi een gebruikte batterij op de juiste manier weg. Let op de volgende punten:

- Breng een lege batterij naar de lokale verzamelplaats voor klein chemisch afval, terug naar de winkel of gooi in een batterijbak.
- Gooi een gebruikte batterij niet in een vuur of water en gooi niet met het gewone huisafval weg.

Geräuschpegel: 81,4 dB (A)

Gemessen nach DIN 45635 bzw. EN27779

INTRODUCTION

Thank you very much for your purchase of the SHARP Electronic Cash Register, Model XE-A212. Please read this manual carefully before operating your machine in order to gain full understanding of functions and features. Please keep this manual for future reference. It will help you if you encounter any operational problems.

CAUTION!

Never install the batteries into the cash register before initializing it. Before you start operating the cash register, you must first initialize it, then install three new R6 or LR6 batteries ("AA" size) on the register. Otherwise, distorted memory contents and malfunction of the cash register will occur. For this procedure, please refer to page 9.

IMPORTANT

- **Be very careful when removing and replacing the printer cover, as the cutter mounted on it is very sharp.**
- **Install the cash register in a location not subject to direct sunlight, unusual temperature changes, high humidity or splashing water.**
Installation in such locations could cause damage to the cabinet and the electronic components.
- **Never operate the register with wet hands.**
The water could seep into the interior of the register and cause component failure.
- **When cleaning your register, use a dry, soft cloth. Never use solvents, such as benzine and/or thinner.**
The use of such chemicals will lead to discoloration or deterioration of the cabinet.
- **The register plugs into any standard wall outlet (official (nominal) voltage).**
Other electrical devices on the same electrical circuit could cause the register to malfunction.
- **For protection against data loss, please install three R6 or LR6 batteries ("AA" size) after initializing the cash register. When handling the batteries, please observe the following:**
Incorrectly using batteries can cause them to burst or leak, possibly damaging the interior of the cash register.
 - **Be sure that the the positive (+) and negative (-) poles of each battery are facing in the proper direction for installation.**
 - **Never mix batteries of different types.**
 - **Never mix old batteries and new ones.**
 - **Never leave dead batteries in the battery compartment.**
 - **Remove the batteries if you do not plan to use the cash register for long periods.**
 - **Should a battery leak, clean out the battery compartment immediately, taking care to avoid letting the battery fluid come into direct contact with your skin.**
 - **For battery disposal, follow the corresponding law in your country.**
- **For complete electrical disconnection, disconnect the main plug.**

**For Easy Set-up, see
"GETTING STARTED" (page 8).**

CONTENTS

| | |
|--|----------|
| INTRODUCTION | 1 |
| IMPORTANT | 1 |
| CONTENTS | 2 |
| PARTS AND THEIR FUNCTIONS | 4 |
| 1 External View | 4 |
| 2 Printer | 4 |
| 3 Mode Switch and Mode Keys | 5 |
| 4 Keyboard | 5 |
| 5 Displays | 7 |
| 6 Drawer Lock Key | 7 |
| GETTING STARTED | 8 |

| |
|------------------|
| FOR THE OPERATOR |
|------------------|

| | |
|---|-----------|
| BASIC SALES ENTRY | 13 |
| 1 Basic Sales Entry Example | 13 |
| 2 Error Warning | 14 |
| 3 Item Entries | 15 |
| Single item entries | 15 |
| Repeat entries | 16 |
| Multiplication entries | 16 |
| Single item cash sale (SICS) entry | 17 |
| PLU level shift (for direct PLU key) | 17 |
| 4 Displaying Subtotals | 19 |
| 5 Finalization of Transaction | 19 |
| Cash or cheque tendering | 19 |
| Cash or cheque sale that does not require tender entry | 19 |
| Credit sale | 20 |
| Mixed-tender sale | 20 |
| 6 Computation of VAT (Value Added Tax)/tax | 20 |
| VAT/tax system | 20 |
| OPTIONAL FEATURES | 21 |
| 1 Auxiliary Entries | 21 |
| Percent calculations (premium or discount) | 21 |
| Deduction entries | 22 |
| Refund entries | 22 |
| Non-add code number entries and printing | 23 |
| 2 Guest Look-up (GLU) | 23 |
| 3 Auxiliary Payment Treatment | 25 |
| Currency exchange | 25 |
| Received-on account entries | 26 |
| Paid-out entries | 26 |
| No sale (exchange) | 26 |
| 4 Automatic Sequence Key (AUTO key) Entries | 26 |
| CORRECTION | 27 |
| 1 Correction of the Last Entry (direct void) | 27 |
| 2 Correction of the Next-to-last or Earlier Entry (indirect void) | 27 |
| 3 Subtotal Void | 28 |
| 4 Correction of Incorrect Entries not Handled by the Direct or Indirect Void Function | 28 |

| | |
|--|-----------|
| PRIOR TO PROGRAMMING | 29 |
| BASIC FUNCTION PROGRAMMING (For Quick Start) | 34 |
| 1 Date and Time Programming | 34 |
| 2 Tax Programming | 34 |
| Tax rate programming | 35 |
| AUXILIARY FUNCTION PROGRAMMING | 36 |
| 1 Department Programming | 36 |
| 2 PLU (Price Look-Up) and Subdepartment Programming | 37 |
| 3 Miscellaneous Key Programming | 40 |
| Rate for <input type="checkbox"/> % and <input type="checkbox"/> EX | 40 |
| Amount for <input type="checkbox"/> ⊖ | 41 |
| Percent rate limitation for <input type="checkbox"/> % | 41 |
| Function parameters for <input type="checkbox"/> % and <input type="checkbox"/> ⊖ | 41 |
| Function parameters for <input type="checkbox"/> EX | 42 |
| Function parameters for <input type="checkbox"/> RA, <input type="checkbox"/> PO, <input type="checkbox"/> CH1, <input type="checkbox"/> CH2, <input type="checkbox"/> CR1, <input type="checkbox"/> CR2 and <input type="checkbox"/> TL | 42 |
| 4 Text Programming | 43 |
| ADVANCED FUNCTION PROGRAMMING | 48 |
| 1 Register Number and Consecutive Number Programming | 48 |
| 2 Various Function Selection Programming 1 | 49 |
| Function selection for miscellaneous keys | 49 |
| Print format | 50 |
| Receipt print format | 50 |
| PLU level shift and GLU function parameters | 51 |
| Other programming | 51 |
| 3 Various Function Selection Programming 2 | 56 |
| Power save mode | 56 |
| Logo message print format | 56 |
| Thermal printer density | 57 |
| Language selection | 57 |
| EJ memory type | 57 |
| Training clerk specification for training mode | 58 |
| AUTO key programming | 58 |
| 4 EURO Programming | 59 |
| 5 Reading Stored Programs | 61 |
| TRAINING MODE | 63 |
| READING (X) AND RESETTING (Z) OF SALES TOTALS | 64 |
| EJ REPORT READING AND RESETTING | 68 |
| OVERRIDE ENTRIES | 69 |
| CORRECTION AFTER FINALIZING A TRANSACTION (Void mode) | 69 |
| EURO MIGRATION FUNCTION | 70 |
| OPERATOR MAINTENANCE | 73 |
| 1 In Case of Power Failure | 73 |
| 2 In Case of Printer Error | 73 |
| 3 Cautions in Handling the Printer and Recording Paper | 73 |
| 4 Replacing the Batteries | 74 |
| 5 Replacing the Paper Roll | 75 |
| 6 Removing a Paper Jam | 77 |
| 7 Cleaning the Printer (Print Head / Sensor / Roller) | 77 |
| 8 Removing the Till and the Drawer | 78 |
| 9 Opening the Drawer by Hand | 78 |
| 10 Before Calling for Service | 79 |
| Error message table | 79 |
| SPECIFICATIONS | 80 |

PARTS AND THEIR FUNCTIONS

1 External View

■ Front view

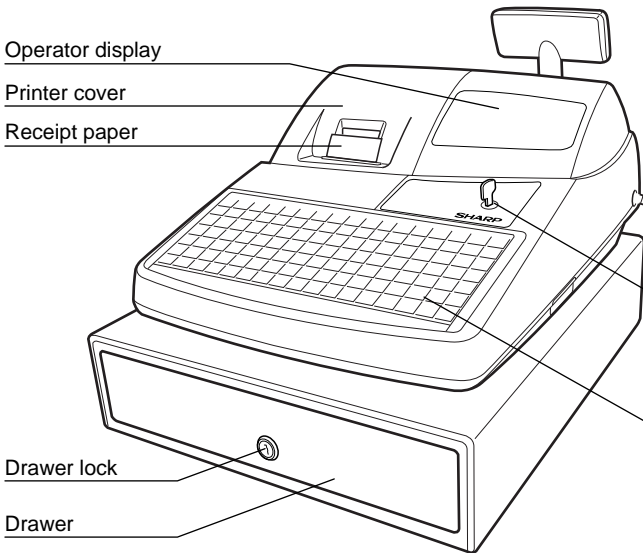

■ Rear view

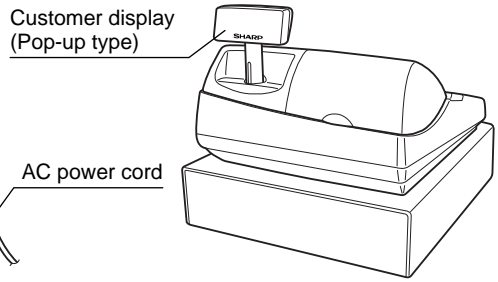

2 Printer

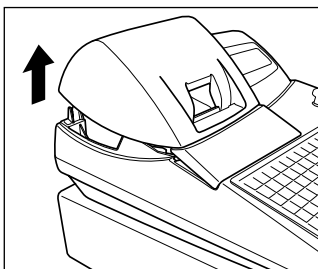

The printer is one station type thermal printer, therefore it does not require any type of ink ribbon or cartridge.

Lift the rear of the printer cover to remove. To re-install, hook the pawls on the cabinet and close.

Caution: The paper cutter is mounted on the printer cover. Be careful not to cut yourself.

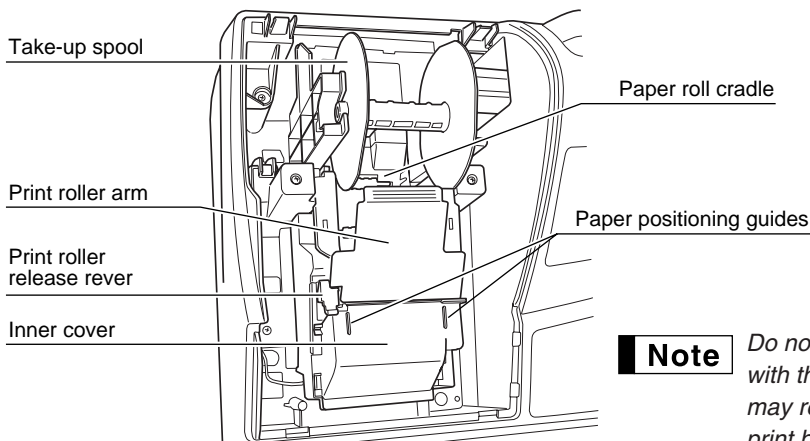

Note

Do not attempt to remove the paper roll with the print roller arm is locked. This may result in damage to the printer and print head.

3 Mode Switch and Mode Keys

The mode switch can be operated by inserting one of the two supplied mode keys - manager (MA) and operator (OP) keys. These keys can be inserted or removed only in the "REG" or "⏻" position.

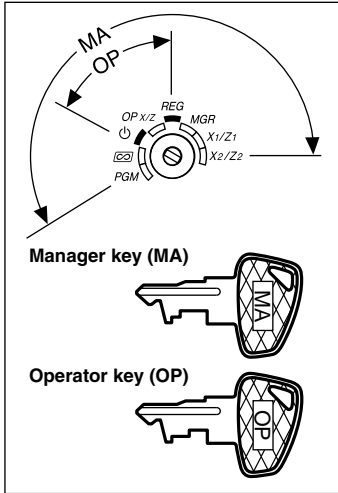

The mode switch has these settings:

- ⏻ :** This mode locks all register operations. (AC power turns off.)
No change occurs to register data.
- OP X/Z:** To take individual clerk X or Z reports, and to take flash reports. It can be used to toggle receipt state "ON" and "OFF" by pressing the **RCPT** key.
- REG:** For entering sales.
- PGM:** To program various items.
- ⊞ :** Enters into the void mode. This mode allows correction after finalizing a transaction.
- MGR:** For manager's entries. The manager can use this mode for an override entry.
- X1/Z1:** To take the X/Z report for various daily totals
- X2/Z2:** To take the X/Z report for periodic (weekly or monthly) consolidation

4 Keyboard

Keyboard layout

| | | | | | | | | | | | | | | | | |
|-------|-----------|---|----|----|----------|----|----|----|----|----|----|----|----|----|----|----|
| ↑ | ESC | 2 | 4 | 6 | GC RCPT | L3 | 7 | 14 | 21 | 28 | 35 | 42 | 49 | 56 | 63 | 70 |
| RCPT | EX | 1 | 3 | 5 | AUTO | L2 | 6 | 13 | 20 | 27 | 34 | 41 | 48 | 55 | 62 | 69 |
| CLK # | VAT | ⊗ | • | CL | DEPT # | L1 | 5 | 12 | 19 | 26 | 33 | 40 | 47 | 54 | 61 | 68 |
| # | PLU / SUB | 7 | 8 | 9 | GLU NBAL | 4 | 11 | 18 | 25 | 32 | 39 | 46 | 53 | 60 | 67 | |
| ⊖ | % | 4 | 5 | 6 | CR1 CR2 | 3 | 10 | 17 | 24 | 31 | 38 | 45 | 52 | 59 | 66 | |
| PO | RA | 1 | 2 | 3 | CH1 CH2 | 2 | 9 | 16 | 23 | 30 | 37 | 44 | 51 | 58 | 65 | |
| ⊞ | RF | 0 | 00 | NS | ST TL | 1 | 8 | 15 | 22 | 29 | 36 | 43 | 50 | 57 | 64 | |

Key names

- | | | |
|----------------------------------|----------------------------|----------------------------------|
| ↑ Paper feed key | ⊖ Discount key | • Decimal point key |
| ESC Escape key | % Percent keys | CL Clear key |
| RCPT Receipt print key | PO Paid-out key | 00 0 ~ 9 Numeric keys |
| CLK # Clerk code entry key | RA Received-on account key | NS No sale key |
| # Non-add code/Time display key | ⊞ Void key | GC RCPT Guest check receipt key |
| EX Foreign currency exchange key | RF Refund key | AUTO Automatic sequence key |
| VAT Value added tax key | 1 ~ 6 Department keys | DEPT # Department code entry key |
| PLU / SUB PLU/Subdepartment key | ⊗ Multiplication key | L1 ~ L3 PLU level shift keys |

GLU Guest look up key

CH1 CH2 Cheque 1 and 2 keys

TL Total key

NBAL New balance key

ST Subtotal key

1 ~ 70 Direct PLU keys

CR1 CR2 Credit 1 and 2 keys

Note

In this manual, key tops are shown in one line, such as **PLU/SUB** for easy reading. Department keys are shown like **1**, and numeric keys are indicated with simple number indication, such as 1, unless otherwise specified.

Keyboard sheet

Two types of keyboard sheets are installed on the cash register; one for ordinal use and one for text programming.

To reinstall the keyboard sheet or a new sheet, please follow the procedure below.

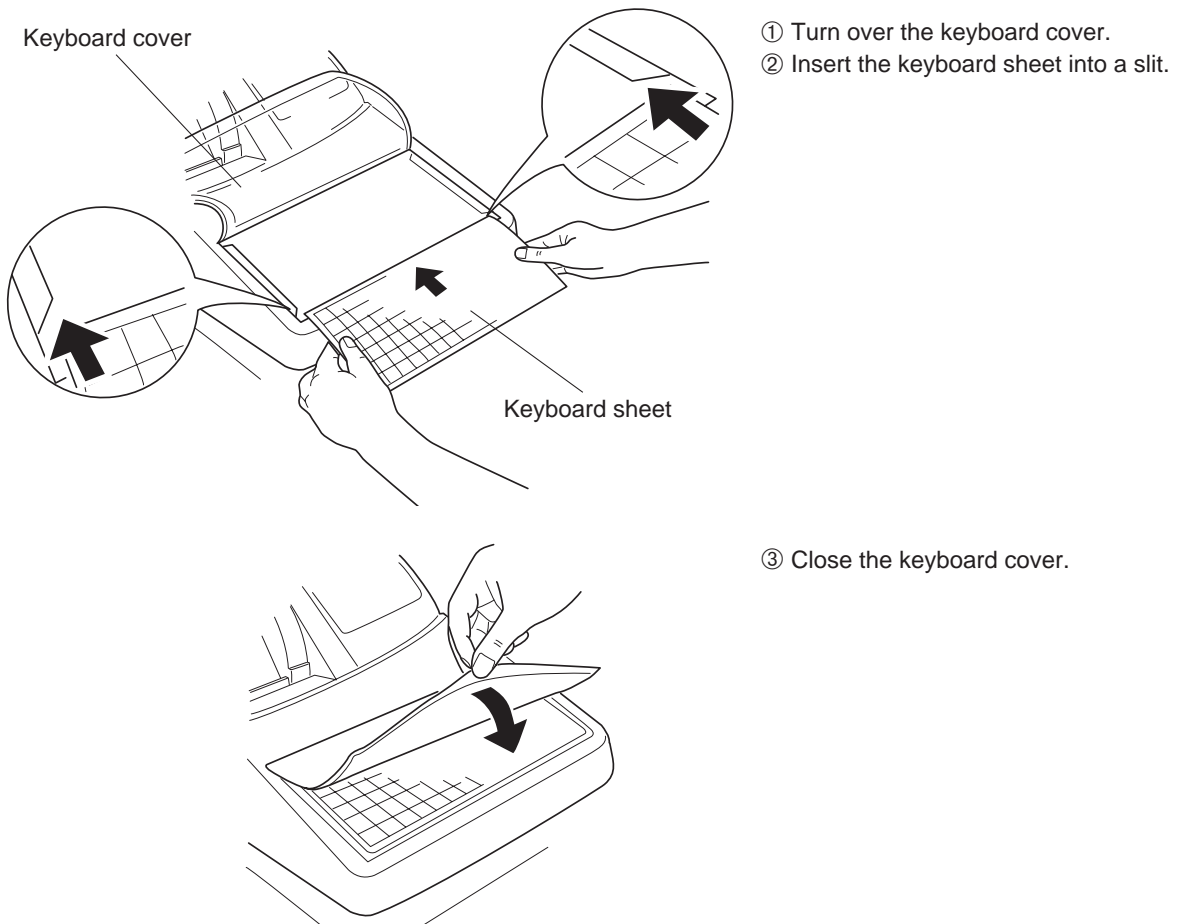

Note

- Do not spread the keyboard cover too far as it might tear the tabs.
- Replace the keyboard sheet with a new one if chance it gets wet. Use of a wet keyboard sheet may cause problems.
- Be sure to use only SHARP-supplied keyboard sheets. Thick or hard sheets can make key operations difficult.
- Place the keyboard sheet evenly under the keyboard cover.
- The keyboard cover will eventually wear out. If your keyboard cover is dirty or broken, replace the cover with a new one. For details, please contact a nearby authorized SHARP dealer.

5 Displays

Operator display

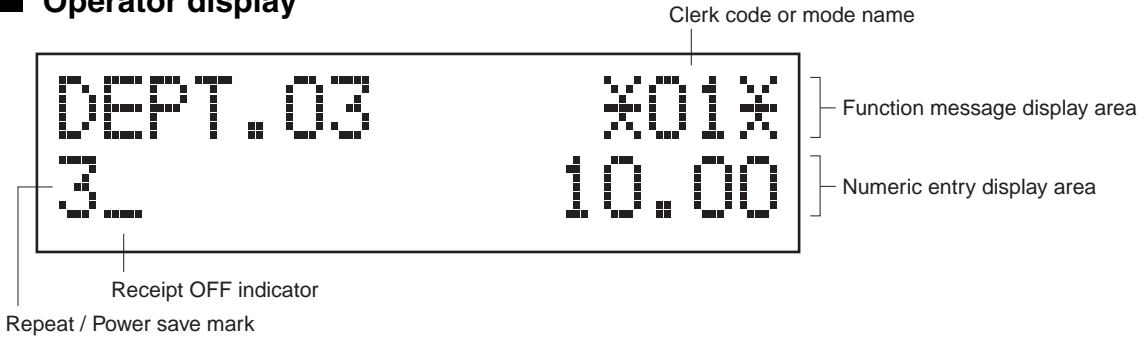

- **Clerk code or Mode name**

The mode you are in is displayed. When a clerk is assigned, the clerk code is displayed in the REG or OP X/Z mode. For example, "X01X" is displayed when clerk 01 is assigned.

- **Repeat mark**

The number of repeats is displayed, starting at "2" and incremental with each repeat. When you have registered ten times, the display will show "0". (2 → 39 → 0 → 1 → 2...)

- **Power save mark**

When the cash register goes into the power save mode, the power save mark (decimal point) lights up.

- **Function message display area**

Item labels of departments and PLU/subdepartments and function texts you use, such as %, (-) and CASH are displayed. For the details of function texts, please refer to pages 45.

When an amount is to be entered or entered, "AMOUNT" is displayed: When an amount is to be entered, ----- is displayed at the numeric entry area with "AMOUNT". When a preset price has been set, the price is displayed at the numeric entry area with "AMOUNT".

- **Numeric entry display area**

Numbers entered using numeric keys are displayed here.

Date and time display

Date and time appear on the display in the OP X/Z, REG, or MGR mode. In the REG or MGR mode, press the key to display the date and time.

Error message

When an error occurs, the corresponding error message is displayed in the function message display area. For details of error messages, please refer to "Error message table" on page 79.

Customer display (Pop-up type)

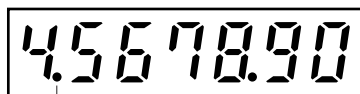

Power save mark (Mark only lights up in the power save mode.)

6 Drawer Lock Key

This key locks and unlocks the drawer. To lock it, turn 90 degrees counterclockwise. To unlock it, turn 90 degrees clockwise.

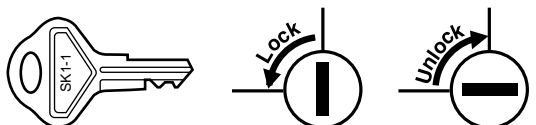

GETTING STARTED

Please follow the procedure shown below.

1

Installing the cash register

Unpack the cash register and make sure all accessories are included. For details of accessories, please refer to "Specifications" section.

For installing the cash register, find a stable surface near an AC outlet where the cash register will not subject to water sources or direct sunlight, then install the register using the fixing angle bracket provided with the register. The fixing angle bracket prevents the register from moving when the drawer opens. By hooking the register on the bracket, you can secure the register to the position.

Follow the procedure shown below for the installation.

How to install the fixing angle bracket

1. Thoroughly clean the location where the fixing angle bracket (B) is to be placed.
2. Peel off the adhesive tape on the fixing angle bracket.
3. Hook the angle bracket onto the hook (A) that is located at the bottom rear of the register.
4. Firmly stick the fixing angle bracket to the table surface that you cleaned above.

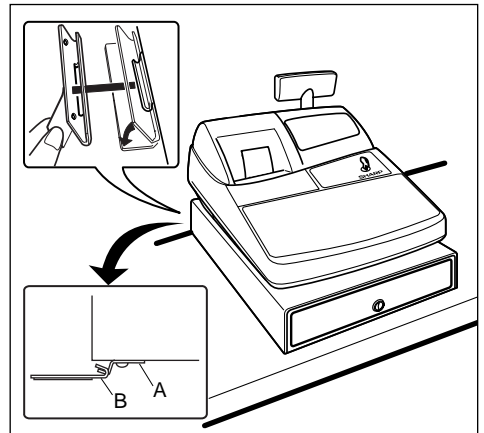

How to remove the register from the fixing angle bracket

1. Lift up the front of the register and pull the register towards you.

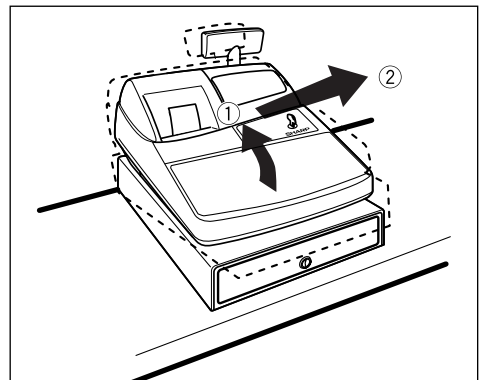

2

Initializing the cash register

In order for the cash register to operate properly, you must initialize it before operating for the first time. Follow this procedure.

1. Insert the manager (MA) key into the mode switch and turn it to the REG position.
2. Insert the plug of the AC power cord into the AC outlet. The buzzer will sound three times.

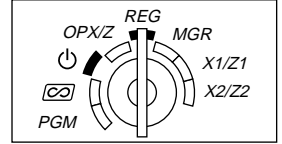

IMPORTANT: This operation must be performed without batteries installed.

3. The cash register has now been initialized. The register display will show "0.00" with "NO BATTERY".

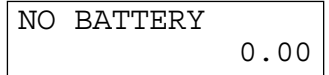

Note

If the buzzer does not sound when the plug is inserted, the initialization has not been done successfully. (This will occur when the voltage is high because you operated the cash register before starting initialization.) Wait at least one minute after pulling out the plug and insert the plug again.

3

Installing batteries

Three new R6 or LR6 batteries ("AA" size) must be installed in the cash register to prevent the data and user-programmed settings from being erased from the memory, when the AC cord is accidentally disconnected or in case of power failure. Once installed, the batteries will last approximately one year before needing replacement. At this time, the warning message "LOW BATTERY" will appear on the display to indicate the batteries are low and must be replaced within two days. If the warning message "NO BATTERY" appears, you must install the batteries at once.

Install three new R6 or LR6 batteries ("AA" size) according to the procedure shown below with the AC cord connected and the mode switch set to the REG position:

1. Push the printer cover forward and detach it.
Be careful with the paper cutter, so as not to cut yourself.
2. Open the battery compartment cover next to the paper roll cradle.

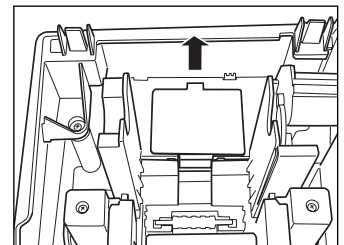

3. Install three new R6 or LR6 batteries ("AA" size) as per the diagram. When the batteries are properly installed "NO BATTERY" message on the display will disappear.
4. Close the battery compartment cover.

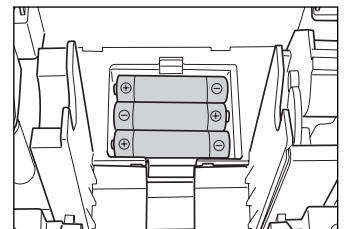

Note

- Be sure to observe precautions shown on page 1 when handling batteries.
- If you press a key by mistake, an error message "PAPER EMPTY" may be displayed. Press the **CL** key to clear message after installing paper rolls.

4

Installing a paper roll

Precaution: The paper cutter is mounted on the printer cover. Take caution when removing and installing the cover.

The register can print receipts or journals. For the printer, you must install the paper roll provided with the register, even when you program the register for not printing receipts or journals.

Install the paper roll according to the procedure shown below with the AC cord connected and the mode switch set to the REG position:

1. Lift up the print roller release lever to unlock and open the print roller arm.

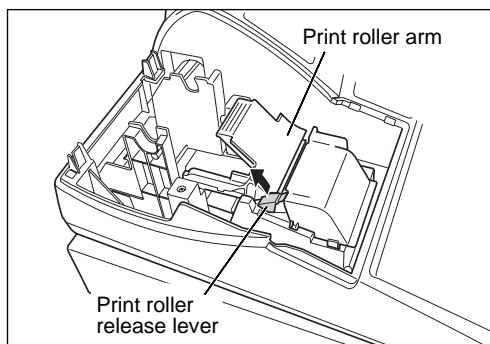

2. Set a paper roll in the paper roll cradle as per the diagram.

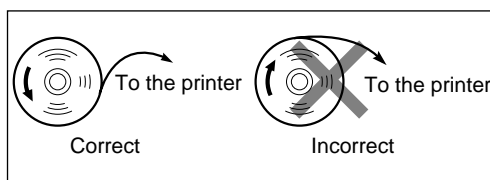

3. Feed the end of the paper along with the paper positioning guides as per the diagram.

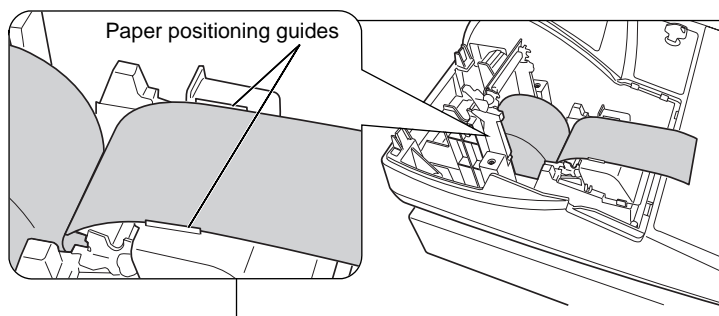

4. While holding down the paper, slowly close the print roller arm, and push down the arm until you hear a click locking the arm. Make sure securely you push down the center of the wing part of the arm as per the diagram. The paper will be fed automatically.

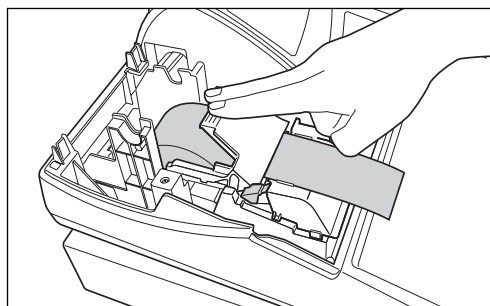

Note

If the print roller arm is not securely locked, printing is not done right. If this problem occurs, open the arm, and close the arm as instructed above.

5. When not using the take-up spool (using as receipt paper):



- Cut off the excess paper using the edge of the inner cover, and replace the printer cover. Press the  key to make sure the paper end comes out of the printer cover and clean paper appears.

Note

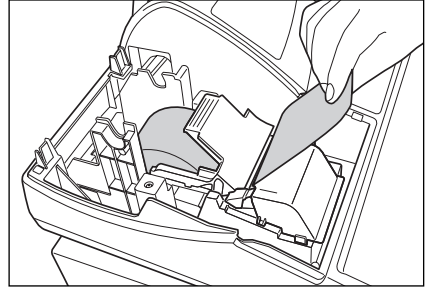
If the paper end does not come out, open the printer cover, and pass the paper end between the paper cutter and the paper guide of the printer cover, and replace the cover.



When using the take-up spool (using as journal paper):

- Insert the end of the paper into the slit in the spool. (Press the  key to feed more paper if required.)
- Wind the paper two or three turns around the spool shaft.
- Set the spool on the bearing, and press the  key to take up excess slack in the paper.
- Replace the printer cover.

Note

When using a paper roll as journal paper, you must change the printing style. Refer to "Print Format" in "Various Function Selection Programming 1" section (Job code 6) for changing the printing style.

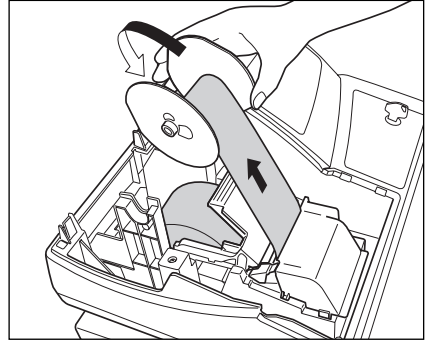

5

Programming date, time and VAT/tax

Note

The cash register provides text languages of English, German, French and Spanish. It is preset to English. If you want to change the language, you must change it before programming. Refer to "Language selection" in "Various Function Selection Programming 2" (Job code 88) section for changing the language.

Before you can proceed with registration of sales, **you must program:**

- **date**
- **time**
- **VAT/tax**

Please refer to the BASIC FUNCTION PROGRAMMING section for details (page 34).

6

Programming other necessary items

While the cash register is pre-programmed so it can be used with minimal setup, it does provide you with optional functions. Especially to use direct PLU keys effectively, you should program for PLU/subdepartments. Before you start programming, please read through the sales operations section to understand optional functions.

Decimal point position (tab) setting for domestic currency

By default, "2" is selected. When your country has a different tab setting, you must change the setting. Please refer to "Other programming" of "Various Function Selection Programming 1" (Job code 61) on page 51.

Rounding system

When your country has a special rounding system, such as Australia, Switzerland, Norway, Sweden, Denmark and South Africa, you must change the setting to suit your country. For the setting for Australia, Switzerland, Norway and South Africa, please refer to "Other programming" of "Various Function Selection Programming 1" (Job code 67) on page 53. For the setting for Sweden and Denmark, please refer to "Other programming" of "Various Function Selection Programming 1" (Job code 69) on page 55.

VAT/tax

The cash register provides 6 kinds of VAT/tax. Select an appropriate VAT/tax system first, then set tax rates (up to 4 rates) and assign taxable status to departments. By default, VAT 1 is assigned for all departments.

Department programming:

The cash register is pre-programmed for departments as follows:

Department: Allow open price entry in normal department, taxable status- taxable 1 for all departments.

PLU/subdepartment programming:

The cash register is preprogrammed for PLUs/subdepartments as follows:

PLU/subdepartment selection: PLU is selected for all PLU codes so that you only have to program unit prices and associated departments for them (by default, unit price is set to 0 and associated department is set to department 1). Function parameters including tax status depend on the status of associated department.

- For direct PLU keys, PLU codes 1 through 70 are assigned for PLU 1 through 70 keys respectively. In case you use the PLU level shift keys, you can add number of direct PLU keys. For the function details, please refer to "PLU level shift (for direct PLU key)" on page 17 and for the programming details, please refer to "Direct PLU key programming" on page 37.

7

Starting sales entries

Now you are ready for sales registration.

BASIC SALES ENTRY

1 Basic Sales Entry Example

Listed below is a basic sales entry example when selling items by cash. For operation details, please refer to each section.

Mode switch setting

1. Turn the mode switch to the REG position.

Clerk assignment

2. Enter your clerk code. (For example, clerk code is 1. Enter 1 using the numeric key and press the **CLK#** key.) The clerk code 1 is automatically selected just after initialization of the cash register.

Item entries

3. Enter the price for the first department item. (For example, for 15.00, enter 1500 using the numeric keys, and press the appropriate department key.)
For department 7 and above, enter the department code using numeric keys and press the **DEPT#** key, then enter the price and press the **DEPT#** key again.

4. Repeat step 3 for all department items.

Displaying subtotals

5. Press the **ST** key to display the amount due.

Finalizing the transaction

6. Enter the amount received from the customer. (You can omit this step if the amount tendered is the same as the subtotal.)
7. Press the **TL** key, and the change due is displayed and the drawer is opened.
8. Tear off the receipt and give it to the customer with his or her change.
9. Close the drawer.

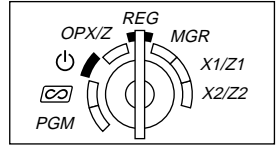

Key operation example

| | | |
|----------------------------|--------------------------------------|------------------------|
| Clerk assignment | → 1 CLK# | CLERK 01 *01* -01- |
| Item entries | { 1500 1 * 2300 2 * | DEPT.01 *01* 15.00 |
| | | DEPT.02 *01* 23.00 |
| Displaying subtotal | → ST | SUBTOTAL *01* 38.00 |
| | 4000 | *01* 4000 |
| Finalizing the transaction | → TL | CHANGE *01* 2.00 |

* **1** **2** : indicate department keys.

(In this example, tax system is set to automatic VAT 1 and the tax rate is set to 6.25%.)

Receipt print

| | | |
|---|----|---|
| SHARP PRESENTS THE XE-A212 SHARP IS THE BEST | | Logo message |
| 26/08/2003 16:42 | 01 | Date/Time/Clerk code |
| 123456#1032 CLERK 01 | | Register number /Consecutive number/Clerk name |
| DEPT.01 *15.00 | | Items Price |
| DEPT.02 *23.00 | | |
| SUBTOTAL *38.00 | | |
| TAX1 ST *38.00 | | Not printed when non-taxable items only are sold. |
| VAT 1 *2.24 | | |
| NET 1 *35.76 | | |
| ITEMS 20 | | Total quantity |
| ***TOTAL *38.00 | | Total amount |
| CASH *40.00 | | Cash tendering/amount received |
| CHANGE *2.00 | | Change |

Clerk assignment

Prior to any item entries, clerks must enter their clerk codes into the register. However, the code entry may not be necessary when the same clerk handles the consecutive transactions.

■ Sign-on (in REG, MGR,  mode)

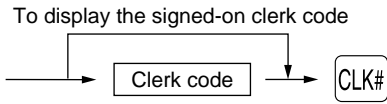

■ Sign-off (in REG, MGR,  mode)

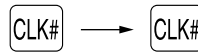

Receipt ON/OFF function

When you use the printer to issue receipts, you can disable receipt printing in the REG mode to save paper using the receipt ON/OFF function. To disable receipt printing, press the  key in the OP X/Z position. This key toggles the receipt printing status ON and OFF. When the function is in the OFF mode, the receipt off indicator “_” is illuminated.

The register will print reports regardless of the receipt state, so the paper roll must be installed.

To issue a receipt when receipt ON/OFF function is set to OFF:

If your customer wants a receipt after you finalized a transaction with the receipt ON/OFF function being OFF status, press the  key. This will produce a receipt. However, if more than 30 items were entered, the receipt will be issued in a summary receipt.

Copy receipt

You can print a copy receipt by pressing the  key when the receipt ON/OFF function is in the “ON” status. To realize this function, you must enable the function. Please refer to page 52 (Job code 63).







Power Save Mode

The register will enter into power save mode when no entries are performed based on the pre-programmed time limit (by default, 30 minutes).

When the register goes to the power save mode, all display lights will turn off except the decimal point at the leftmost position of the lower line. The register will return to the normal operation mode when any key is pressed or a mode is changed with the mode key. Please note when the register is recovered by a key entry, its key entry is invalid. After the recovery, start the key entry from the beginning.

2 Error Warning

In the following examples, your register will go into an error state accompanied with a warning beep and a corresponding error message. Clear the error state by pressing the  key and take the proper action. Please refer to the error message table on page 79.

- Enter over a 32-digit number (entry limit overflow): Cancel the entry and re-enter the correct number.
- An error in key operation: Clear the error and continue operation.
- An entry beyond a programmed amount entry limit: Check to see if the entered amount is correct. If it is correct, it can be rung up in the MGR mode. Contact your manager.
- An including-tax subtotal exceeds eight digits: Delete the subtotal by pressing the  key and press the , , ,  or  key to finalize the transaction.

Error escape function

To quit a transaction due to an error or an unforeseen event, use the error escape function as shown below:

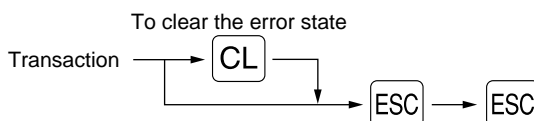

The transaction is voided (treated as a subtotal void) and the receipt is issued by this function. If you have already entered a tendered amount, the operation is finalized as a cash sale.

3 Item Entries

Single item entries

1. Department entries

The cash register provides a maximum of 50 departments for a merchandise classification. Group attributes, such as taxable status, are applied to items when they are entered to the departments.

- **When using the department keys (for department 1 to 6)**

For department 1 to 6, enter a unit price and press a department key. If you use a programmed unit price, press a department key only.

When using a programmed unit price

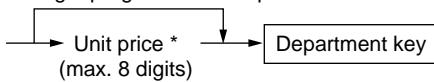

* Less than the programmed upper limit amounts
When zero is entered, only the sales quantity is added.

- **When using the department code entry key**

Enter a department (dept.) code and press the **DEPT#** key, then enter a unit price and press the **DEPT#** key again. If you use a programmed unit price, enter a dept. code and press the **DEPT#** key.

When using a programmed unit price

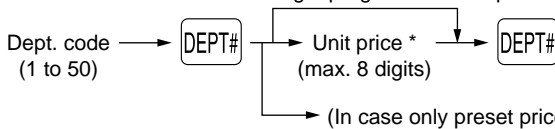

* Less than the programmed upper limit amounts
When zero is entered, only the sales quantity is added.

2. PLU/subdepartment entries

For another merchandise classification, the cash register provides a maximum of 1200 PLUs/subdepartments. PLUs are used to call up preset prices by pressing direct PLU keys or entering PLU codes with a press of the **PLU/SUB** key. Subdepartments are used to classify merchandise into smaller groups under the departments. Every PLU and subdepartment has a code from 1 to 1200, and should belong to a department to obtain attributes of that department.

By default, the cash register is preprogrammed to be able to use 1 to 210 codes, and these 210 codes are set to PLU mode and zero for unit price.

To extend the number of PLU codes to 1200, please refer to “EJ memory type” on page 57, and for other PLU/subdepartment programming, refer to “PLU and Subdepartment Programming” on page 37.

- **PLU entries**

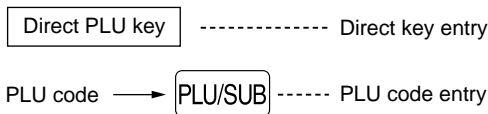

- **Subdepartment (open PLU) entries**

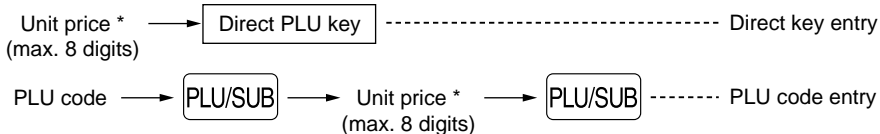

* Less than the programmed upper limit amounts
When zero is entered, only the sales quantity is added.

Key operation example

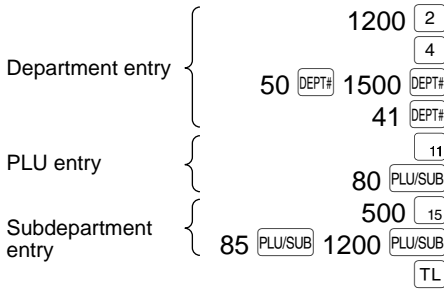

Receipt print

| | |
|-------------|---------------|
| DEPT. 02 | *12.00 |
| DEPT. 04 | *1.50 |
| DEPT. 50 | *15.00 |
| DEPT. 41 | *3.25 |
| PLU. 0011 | *8.25 |
| PLU. 0080 | *2.50 |
| PLU. 0015 | *5.00 |
| PLU. 0085 | *12.00 |
| ITEMS | 8Q |
| CASH | *59.50 |

Repeat entries

You can use this function for entering a sale of two or more of the same items. Consecutive pressing of a department key, [DEPT#] key, a direct PLU key or [PLU/SUB] key is as shown on key operation example below.

Key operation example

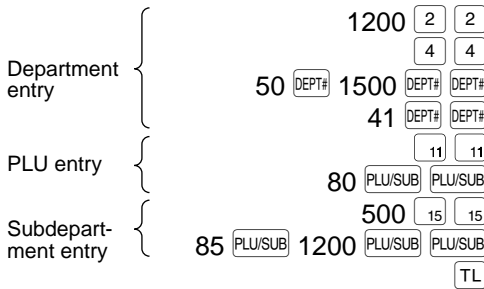

Receipt print

| | |
|-------------|----------------|
| DEPT. 02 | *12.00 |
| DEPT. 02 | *12.00 |
| DEPT. 04 | *1.50 |
| DEPT. 04 | *1.50 |
| DEPT. 50 | *15.00 |
| DEPT. 50 | *15.00 |
| DEPT. 41 | *3.25 |
| DEPT. 41 | *3.25 |
| PLU. 0011 | *8.25 |
| PLU. 0011 | *8.25 |
| PLU. 0080 | *2.50 |
| PLU. 0080 | *2.50 |
| PLU. 0015 | *5.00 |
| PLU. 0015 | *5.00 |
| PLU. 0085 | *12.00 |
| PLU. 0085 | *12.00 |
| ITEMS | 16Q |
| CASH | *119.00 |

Multiplication entries

When selling a large quantity of items, it is convenient to use the multiplication entry method. Enter quantity using numeric keys and press the [⊗] key before starting item entry as shown in the example below.

Note When programmed to allow fractional quantity entries, you can enter up to four integers and three digit decimal, though the quantity is counted as one for sales reports. To enter a fractional quantity, use the decimal point key between integer and decimal.

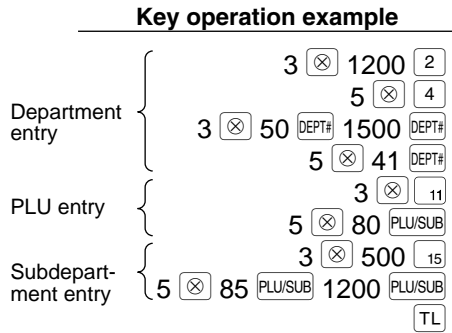

Receipt print

| | |
|-----------|---------|
| 3x 12.00 | |
| DEPT. 02 | *36.00 |
| 5x 1.50 | |
| DEPT. 04 | *7.50 |
| 3x 15.00 | |
| DEPT. 50 | *45.00 |
| 5x 3.25 | |
| DEPT. 41 | *16.25 |
| 3x 8.25 | |
| PLU. 0011 | *24.75 |
| 5x 2.50 | |
| PLU. 0080 | *12.50 |
| 3x 5.00 | |
| PLU. 0015 | *15.00 |
| 5x 12.00 | |
| PLU. 0085 | *60.00 |
| ITEMS | 32Q |
| CASH | *217.00 |

Single item cash sale (SICS) entry

- This function is useful when a sale is for only one item and is for cash. This function is applicable only to those departments that have been set for SICS or to their associated PLUs or subdepartments.
- The transaction is complete and the drawer opens as soon as you press the department key, DEPT# key, the direct PLU key or PLU/SUB key.

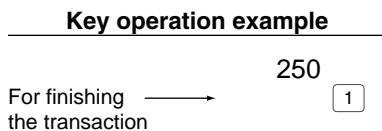

Receipt print

| | |
|----------|-------|
| DEPT. 01 | *2.50 |
| ITEMS | 1Q |
| CASH | *2.50 |

Note If an entry to a department or PLU/subdepartment set for SICS follows the ones to departments or PLUs/subdepartments not set for SICS, it does not finalize and results in a normal sale.

PLU level shift (for direct PLU key)

This shift can double or triple the number of direct PLU keys on your register without adding additional direct PLU keys. You can use direct PLU keys in three levels by utilizing shift keys L1, L2, and L3. These keys have the following functions.

- L1: Shifts the PLU level from level 2 or 3 to level 1 (ordinary level).
- L2: Shifts the PLU level from level 1 or 3 to level 2.
- L3: Shifts the PLU level from level 1 or 2 to level 3.

You can select one of the two PLU level shift modes — automatic return mode* and lock shift mode** — and decide whether to allow PLU level shift in both the REG and MGR modes or in the MGR mode alone.

* The automatic return mode automatically shifts the PLU level back to level 1. You can select whether the PLU level should return to level 1 each time you enter one item or each time you finalize one transaction.

** The lock shift mode holds the current PLU level until pressing of a PLU level shift key.

By default, you can operate PLU level shift in both the REG and MGR modes under the automatic return mode (returning to level 1 after an item entry). To change the setting, please refer to “PLU level shift and GLU function parameters” on page 51.

• Automatic return mode

Returning to level 1 after an item entry (default)

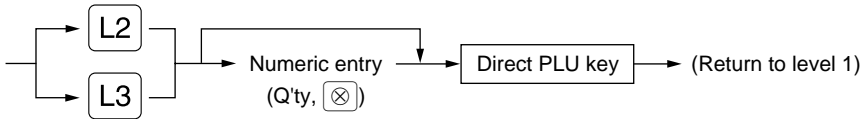

Returning to level 1 after finalizing a transaction

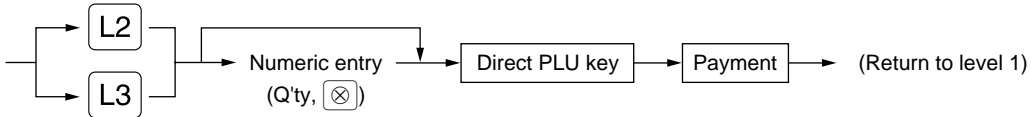

• Lock shift mode

To shift the level of another PLU

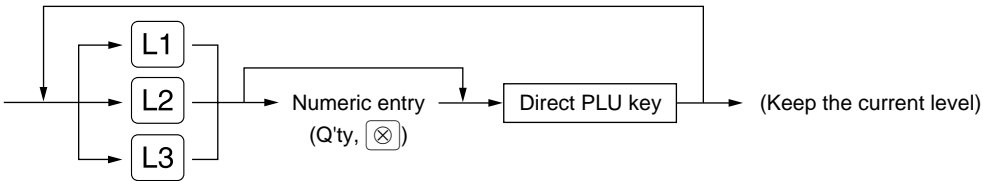

Note If you select the automatic return mode, it is not necessary to use the **L1** key on the keyboard, but if you select the lock shift mode, it is necessary to use the key.

When your machine has been programmed for the automatic return mode (returning to level 1 after an item entry):

| | | | | | | | | | | | | | | | |
|--|--|----------|-------|----------|-------|----------|-------|----------|-------|--|--|-------|----|-------------|---------------|
| <p>Key operation example</p> <p>The machine returns to level 1 automatically.</p> <div style="display: flex; align-items: center;"> <div style="border: 1px solid black; padding: 2px; margin-right: 5px;">L2</div> <div style="display: flex; flex-direction: column; gap: 5px;"> <div style="border: 1px solid black; padding: 2px;">1</div> <div style="border: 1px solid black; padding: 2px;">1</div> <div style="border: 1px solid black; padding: 2px;">2</div> <div style="border: 1px solid black; padding: 2px;">1</div> <div style="border: 1px solid black; padding: 2px;">TL</div> </div> </div> | <p>Receipt print</p> <table border="1" style="width: 100%; border-collapse: collapse;"> <tr><td>PLU.0001</td><td style="text-align: right;">*5.00</td></tr> <tr><td>PLU.0071</td><td style="text-align: right;">*3.25</td></tr> <tr><td>PLU.0002</td><td style="text-align: right;">*5.70</td></tr> <tr><td>PLU.0001</td><td style="text-align: right;">*5.00</td></tr> <tr><td colspan="2"> </td></tr> <tr><td>ITEMS</td><td style="text-align: right;">4Q</td></tr> <tr><td>CASH</td><td style="text-align: right;">*18.95</td></tr> </table> | PLU.0001 | *5.00 | PLU.0071 | *3.25 | PLU.0002 | *5.70 | PLU.0001 | *5.00 | | | ITEMS | 4Q | CASH | *18.95 |
| PLU.0001 | *5.00 | | | | | | | | | | | | | | |
| PLU.0071 | *3.25 | | | | | | | | | | | | | | |
| PLU.0002 | *5.70 | | | | | | | | | | | | | | |
| PLU.0001 | *5.00 | | | | | | | | | | | | | | |
| | | | | | | | | | | | | | | | |
| ITEMS | 4Q | | | | | | | | | | | | | | |
| CASH | *18.95 | | | | | | | | | | | | | | |

When your machine has been programmed for the lock shift mode:

| | | | | | | | | | | | | | | | | | |
|---|--|----------|-------|----------|-------|----------|-------|----------|-------|----------|-------|--|--|-------|----|-------------|---------------|
| <p>Key operation example</p> <p>The machine keeps the level 2 until other level shift key is pressed.</p> <div style="display: flex; align-items: center;"> <div style="font-size: 3em; margin-right: 10px;">}</div> <div style="display: flex; flex-direction: column; gap: 5px;"> <div style="display: flex; gap: 5px;"><div style="border: 1px solid black; padding: 2px;">L1</div><div style="border: 1px solid black; padding: 2px;">1</div></div> <div style="display: flex; gap: 5px;"><div style="border: 1px solid black; padding: 2px;">L2</div><div style="border: 1px solid black; padding: 2px;">1</div></div> <div style="display: flex; gap: 5px;"><div style="border: 1px solid black; padding: 2px;">2</div></div> <div style="display: flex; gap: 5px;"><div style="border: 1px solid black; padding: 2px;">1</div></div> <div style="display: flex; gap: 5px;"><div style="border: 1px solid black; padding: 2px;">L1</div><div style="border: 1px solid black; padding: 2px;">1</div></div> <div style="border: 1px solid black; padding: 2px;">TL</div> </div> </div> | <p>Receipt print</p> <table border="1" style="width: 100%; border-collapse: collapse;"> <tr><td>PLU.0001</td><td style="text-align: right;">*5.00</td></tr> <tr><td>PLU.0071</td><td style="text-align: right;">*3.25</td></tr> <tr><td>PLU.0072</td><td style="text-align: right;">*1.50</td></tr> <tr><td>PLU.0071</td><td style="text-align: right;">*3.25</td></tr> <tr><td>PLU.0001</td><td style="text-align: right;">*5.00</td></tr> <tr><td colspan="2"> </td></tr> <tr><td>ITEMS</td><td style="text-align: right;">5Q</td></tr> <tr><td>CASH</td><td style="text-align: right;">*18.00</td></tr> </table> | PLU.0001 | *5.00 | PLU.0071 | *3.25 | PLU.0072 | *1.50 | PLU.0071 | *3.25 | PLU.0001 | *5.00 | | | ITEMS | 5Q | CASH | *18.00 |
| PLU.0001 | *5.00 | | | | | | | | | | | | | | | | |
| PLU.0071 | *3.25 | | | | | | | | | | | | | | | | |
| PLU.0072 | *1.50 | | | | | | | | | | | | | | | | |
| PLU.0071 | *3.25 | | | | | | | | | | | | | | | | |
| PLU.0001 | *5.00 | | | | | | | | | | | | | | | | |
| | | | | | | | | | | | | | | | | | |
| ITEMS | 5Q | | | | | | | | | | | | | | | | |
| CASH | *18.00 | | | | | | | | | | | | | | | | |

4 Displaying Subtotals

The subtotal is displayed by pressing the **[ST]** key. When you press it, the subtotal of all entries which have been made is displayed with the function message "SUBTOTAL".

Note Subtotal will not be printed on a receipt on the current factory setting. If you want to print it, change the setting by programming. Refer to "Receipt print format" (Job code 7) on page 50.

5 Finalization of Transaction

■ Cash or cheque tendering

Press the **[ST]** key to get a subtotal, enter the amount tendered by your customer, then press the **[TL]** key if it is a cash tender or press a cheque key (**[CH1]** or **[CH2]**) if it is a cheque tender. When the amount tendered is greater than the amount of the sale, the register will show the change due amount with the function message "CHANGE". Otherwise the register will show a deficit with the function message "DUE". You now must make a correct tender entry.

Cash tendering

Key operation example

1000 **[ST]**
[TL]

Receipt print

| | | |
|----------|----|--------|
| ITEMS | 3Q | |
| ***TOTAL | | *7.35 |
| CASH | | *10.00 |
| CHANGE | | *2.65 |

Cheque tendering

Key operation example

1000 **[ST]**
[CH1]

Receipt print

| | | |
|----------|----|--------|
| ITEMS | 3Q | |
| ***TOTAL | | *7.35 |
| CHECK1 | | *10.00 |
| CHANGE | | *2.65 |

■ Cash or cheque sale that does not require tender entry

Enter items and press the **[TL]** key if it is a cash sale or press a cheque key if it is a cheque sale. The register will display the total sale amount.

Key operation example

300 **[6]**
[10]
[TL]

Receipt print

| | | |
|----------|----|--------|
| DEPT.06 | | *3.00 |
| PLU.0010 | | *7.15 |
| ITEMS | 2Q | |
| CASH | | *10.15 |

In the case of cheque 1 sale

| | | |
|--------|----|--------|
| ITEMS | 2Q | |
| CHECK1 | | *10.15 |

Note When programmed not to allow "direct non-tender finalization after tendering" (Job code 63, refer to page 52), you must always enter a tender amount.

■ Credit sale

Enter items and press a credit key (**CR1** or **CR2**).

Key operation example

2500 **6**
 7 **DEPT#** 3250 **DEPT#**
CR1

Receipt print

| | |
|----------|--------|
| DEPT. 06 | *25.00 |
| DEPT. 07 | *32.50 |
| ITEMS | 2Q |
| CREDIT1 | *57.50 |

■ Mixed-tender sale

You can perform mixed-tendering of cheque and cash, cash and credit, and cheque and credit.

Key operation example

}
ST
 950 **TL**
CR2

Receipt print

| | |
|----------|--------|
| ITEMS | 3Q |
| ***TOTAL | *49.50 |
| CASH | *9.50 |
| CREDIT2 | *40.00 |

6 Computation of VAT (Value Added Tax)/tax

■ VAT/ tax system

The cash register may be programmed for the following six VAT/tax systems. The cash register is pre-programmed as automatic VAT 1-4 system.

Automatic VAT 1-4 system (Automatic operation method using programmed percentages)

This system, at settlement, calculates VAT for taxable 1 through 4 subtotals by using the corresponding programmed percentages.

Automatic tax 1-4 system (Automatic operation method using programmed percentages)

This system, at settlement, calculates taxes for taxable 1 through 4 subtotals by using the corresponding programmed percentages, and also adds the the calculated taxes to those subtotals, respectively.

Manual VAT 1-4 system (Manual entry method using programmed percentages)

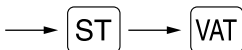

This system provides the VAT calculation for taxable 1 through 4 subtotals. This calculation is performed using the corresponding programmed percentages when the **VAT** key is pressed just after the **ST** key.

Manual VAT 1 system (Manual entry method for subtotals that uses VAT 1 preset percentages)

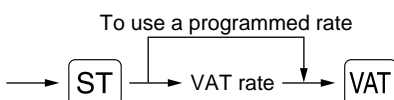

This system enables the VAT calculation for the then subtotal. This calculation is performed using the VAT 1 preset percentages when the **VAT** key is pressed just after the **ST** key. For this system, the keyed-in tax rate can be used.

Manual tax 1-4 system (Manual entry method using preset percentages)

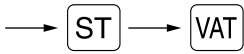

This system provides the tax calculation for taxable 1 through 4 subtotals. This calculation is performed using the corresponding programmed percentages when the **VAT** key is pressed just after the **ST** key. After this calculation, you must finalize the transaction.

Automatic VAT 1 and automatic tax 2-4 system

This system enables the calculation in the combination with automatic VAT 1 and automatic tax 2 through 4. The combination can be any of VAT1 corresponding to taxable 1 and any of tax 2 through 4 corresponding to taxable 2 through taxable 4 for each item. The tax amount is calculated automatically with the percentages previously programmed for these taxes.

Note

- The tax status of PLU/subdepartment depends on the tax status of the department which the PLU/subdepartment belongs to.
- VAT/tax assignment symbol can be printed at the fixed right position near the amount on the receipt as follows:

VAT1/tax1 —————> A
 VAT2/tax2 —————> B
 VAT3/tax3 —————> C
 VAT4/tax4 —————> D

When the multiple VAT/tax is assigned to a department or a PLU, a symbol of the lowest number assigned to VAT/tax rate will be printed. For programming, please refer to "Various Function Selection Programming 1" (Job code 66) on page 53.

OPTIONAL FEATURES

1 Auxiliary Entries

■ Percent calculations (premium or discount)

Your register provides the percent calculation for the subtotal and/or each item entry depending on the programming.

- Percentage: 0.01 to 100.00% (Depending on the programming)
 Application of preset rate (if programmed) and manual rate entry are available.

Percent calculation for subtotal

Key operation example

4
 140

 10

Receipt print

| | |
|-----------|--------|
| 4x 1.40 | |
| DEPT. 05 | *5.60 |
| PLU. 0002 | *5.70 |
| SUBTOTAL | *11.30 |
| | -10% |
| % | -1.13 |
| ITEMS | 5Q |
| CASH | *10.17 |

Percent calculation for item entries

Key operation example

800
 7 5

(When premium and 15% are programmed for the key)

Receipt print

| | |
|-------------|---------------|
| DEPT. 06 | *8.00 |
| | 7.5% |
| % | *0.60 |
| PLU. 0010 | *7.15 |
| | 15.00% |
| % | *1.07 |
| ITEMS | 2Q |
| CASH | *16.82 |

■ Deduction entries

Your register allows you to deduct a preset amount or a certain amount manually entered, which are less than a programmed upper limit. These calculations can be after the entry of an item and/or the computation of subtotal depending on the programming.

Deduction for subtotal

Key operation example

575

 100

Receipt print

| | |
|-------------|---------------|
| DEPT. 06 | *5.75 |
| PLU. 0010 | *7.15 |
| SUBTOTAL | *12.90 |
| (-) | -1.00 |
| ITEMS | 2Q |
| CASH | *11.90 |

Deduction for item entries

Key operation example

7 675

(When a deduction amount of 0.75 is programmed.)

Receipt print

| | |
|-------------|--------------|
| DEPT. 07 | *6.75 |
| (-) | -0.75 |
| ITEMS | 1Q |
| CASH | *6.00 |

■ Refund entries

For departments 1 to 6, enter the refund amount and press the key, and then press the corresponding department key (when using the preset price, omit entering the amount), and for a departments 7 to 50, enter the department code and press the and keys, then enter the refund amount and press the key if necessary.

For a refund of a PLU item, press the key and the corresponding direct PLU key, or enter the PLU code and press the key, then press the key.

For a refund of a subdepartment item, enter the refund amount and press the key, then press the corresponding direct PLU key, or enter the PLU code and press the and keys, then enter the refund amount and press the key.

Key operation example

250 [RF] [6]
 41 [RF] [DEPT#] 100 [DEPT#]
 7 [⊗]
 [RF] [13]
 85 [RF] [PLU/SUB] 150 [PLU/SUB]
 [TL]

Receipt print

| | |
|-----------|---------|
| DEPT. 06 | R-2.50 |
| DEPT. 41 | R-1.00 |
| -7x 2.10 | |
| PLU. 0013 | R-14.70 |
| PLU. 0085 | R-1.50 |
| ITEMS | 0Q |
| CHANGE | *19.70 |

■ Non-add code number entries and printing

You can enter a non-add code number such as a customer's code number and credit card number, a maximum of 16 digits, at any point during the entry of a sale. The cash register will print it at once. To enter a non-add code number, enter the number and press the [#] key.

Key operation example

1230 [#]
 1500 [6]
 [CR1]

Receipt print

| | |
|-------------------|--------|
| #0000000000001230 | |
| DEPT. 06 | *15.00 |
| ITEMS | 1Q |
| CREDIT1 | *15.00 |

2 Guest Look-up (GLU)

This feature is used to store and recall previous balances when a guest look-up (GLU) code is entered. You can accept re-order and issue bills with GLU codes. The GLU code refers to a code that is used whenever the guest check must be accessed for re-ordering or final payment. The GLU code can be 1 to 50.

For new guest

For a new guest, open a new guest check by assigning a GLU code.

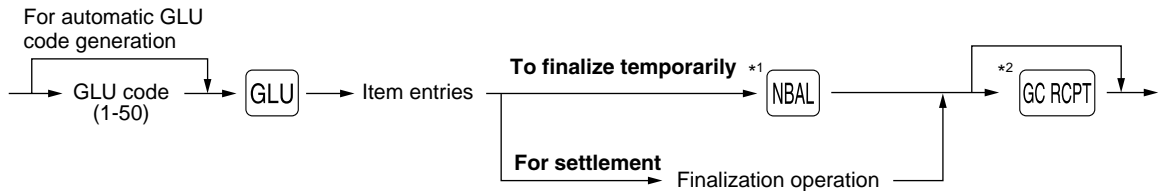

*1: The tax is not calculated.

*2: Press the [GC RCPT] key to issue a guest check receipt (bill). A print sample is shown on the next page.

Key operation example

11 [GLU]
 3500 [2]
 2700 [3]
 [NBAL]

Receipt print

| | | |
|----------|--------|------------------|
| GLU# 1 1 | | GLU code |
| ***PBAL | *0.00 | Previous balance |
| DEPT. 02 | *35.00 | |
| DEPT. 03 | *27.00 | |
| ***NBAL | *62.00 | New balance |

Note

- Your register can be programmed to generate GLU codes automatically in a sequential fashion. If your register has not been programmed to do so, each GLU code must be entered manually. By default, GLU codes are generated automatically. For the programming, please refer to “Other programming” (job code 68) on page 54.
- You can enter a maximum of 50 items for each GLU code. When the machine detects only area for five items are left on the GLU buffer, the operator display shows “5 ITEMS REMAIN” to warn you the number of items you can enter furthermore and the number decrease one by one. When an error message “BUFFER FULL” is displayed, you cannot enter an item anymore. By default, the details of items for each GLU are cleared when you press the **GC RCPT** key. You can clear the details when you press the **NBAL** key as well the **GC RCPT** key when you change the default setting. To change the setting, please refer to “PLU level shift and GLU function parameters” on page 51.
- You can change the printing style so that previous balance (PBAL) and new balance (NBAL) are printed on guest check receipts. To change the setting, please refer to “PLU level shift and GLU function parameters” on page 51.

Additional ordering

For making additional entries for a GLU already generated and not settled yet (hereinafter referred to as open GLU), enter the corresponding open GLU code and press the **GLU** key to recall the previous balance of the open GLU, then start item entries.

By default, when entering an open GLU code, the cash register does not check if the clerk code is the same as the new order was made for the guest. If you want the register check the clerk code, change the setting on “PLU level shift and GLU function parameters” (page 51). When the code is not the same, the register shows the error message “NO AUTHORITY” and does not accept additional order.

→ Open GLU code (1-50) → **GLU** → Item entries → (Same as the operation for new guest)

Key operation example

11 **GLU**
 1400 **5**
 1600 **6**
NBAL

Receipt print

GLU#1 1
 ***PBAL *62.00
 DEPT. 05 *14.00
 DEPT. 06 *16.00
 ***NBAL *92.00

Settlement**Key operation example**

11 **GLU**
TL

Receipt print

GLU#1 1
 ***PBAL *92.00
 ITEMS 4Q
 CASH *92.00

Guest check receipt (bill)

GC RCPT

* **BILL** *
 GLU#1 1
 DEPT. 02 *35.00
 DEPT. 03 *27.00
 DEPT. 05 *14.00
 DEPT. 06 *16.00
 ITEMS 4Q
 CASH *92.00

3 Auxiliary Payment Treatment

■ Currency exchange

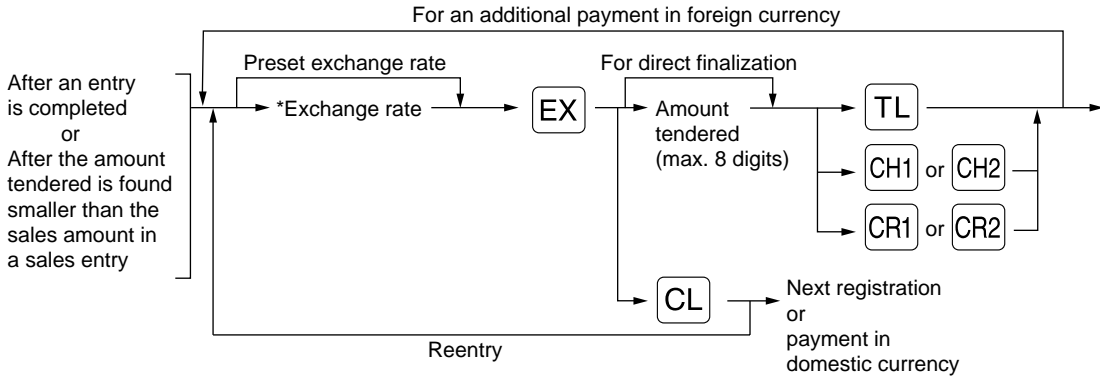

*Exchange rate: 0.000000 to 999.999999

- Note**
- Press the **CL** key after pressing the **EX** key to cancel payment in a foreign currency.
 - If “Yes” is selected for cheque and credit operation when tendering in foreign currency in EURO programming, you can finalize a sale in foreign currency using the **CH1**, **CH2**, **CR1** or **CR2** key with preset exchange rate operation.
 - If programmed, a foreign currency symbol is printed when you use a preset rate.

Applying preset exchange rate

Key operation example

| | | |
|-------------------------------------|-------|------------|
| | 2300 | 6 |
| Currency exchange | 7 | DEPT# 4650 |
| | | EX |
| Amount tendered in foreign currency | 10000 | TL |

(When a currency exchange rate of 0.939938 is programmed for the **EX** key.)

Receipt print

| | | |
|----------|-------------|-------------------|
| DEPT. 06 | *23.00 | |
| DEPT. 07 | *46.50 | |
| ITEMS | 20 | |
| ***TOTAL | *69.50 | Domestic currency |
| EXCH1 | 0.939938 | Exchange rate |
| | US \$65.33 | Foreign currency |
| CASH | US \$100.00 | |
| CHANGE | *36.88 | Domestic currency |

Foreign currency symbol
(Printed if programmed)

Applying manual exchange rate

Key operation example

| | | |
|---------------|-------|------------|
| | 2300 | 6 |
| | 7 | DEPT# 4650 |
| Exchange rate | 1 | . 275 |
| | | EX |
| | 10000 | TL |

Receipt print

| | |
|----------|--------|
| DEPT. 06 | *23.00 |
| DEPT. 07 | *46.50 |
| ITEMS | 20 |
| ***TOTAL | *69.50 |
| EXCH2 | 1.275 |
| | 88.62 |
| CASH | 100.00 |
| CHANGE | *8.92 |

■ Received-on account entries

When you receive on account from a customer, use the **RA** key. For the received-on-account (RA) entry, enter the amount, and press the **RA** key.

Note Cash tendering only available for RA operation.

Key operation example

12345 **#**
4800 **RA**

Receipt print

#0000000000012345
***RA *48.00

■ Paid-out entries

When you pay an amount to a vendor, use the **PO** key. For the paid-out (PO) entry, enter the amount and press the **PO** key.

Note Cash tendering only available for PO operation.

Key operation example

54321 **#**
2300 **PO**

Receipt print

#0000000000054321
***PO *23.00

■ No sale (exchange)

When you need to open the drawer with no sale, press the **NS** key. The drawer will open and printer will print "NO SALE" on the receipt or journal. If you let the machine print a non-add code number before pressing the **NS** key, a no sale entry is achieved and a non-add code number is printed.

#0000000000045678
NO SALE

4 Automatic Sequence Key (**AUTO** key) Entries

You can achieve a programmed transaction simply by pressing the **AUTO** key.

Key operation example

AUTO
(**AUTO** = 500 **6** **TL**)

Receipt print

DEPT. 06 *5.00
ITEMS 1Q
CASH *5.00

CORRECTION

1 Correction of the Last Entry (direct void)

If you make an incorrect entry relating to a department, PLU/subdepartment, percentage (%), discount (⊖) or refund, you can void this entry by pressing the ∞ key immediately after the incorrect entry.

| Key operation example | Receipt print | | | | | | | | | | | | | | | | | | | | | | | | | | | | | | | | |
|---|---|----------|--------|----------|---------|-----------|-------|-----------|--------|----------|-------|--|--------|----|-------|----|--------|----------|-------|-----|-------|-----|--------|----------|--------|----------|---------|--|--|-------|----|-------------|--------------|
| 1250 [6] [∞] [2] [∞] 8 [DEPT#] 600 [DEPT#] [%] [∞] 328 [9] 28 [⊖] [∞] 250 [RF] [6] [∞] [TL] | <table border="0" style="width: 100%;"> <tr><td>DEPT. 06</td><td>*12.50</td></tr> <tr><td>DEPT. 06</td><td>∞-12.50</td></tr> <tr><td>PLU. 0002</td><td>*1.50</td></tr> <tr><td>PLU. 0002</td><td>∞-1.50</td></tr> <tr><td>DEPT. 08</td><td>*6.00</td></tr> <tr><td></td><td>15.00%</td></tr> <tr><td>%2</td><td>*0.90</td></tr> <tr><td>%2</td><td>∞-0.90</td></tr> <tr><td>DEPT. 09</td><td>*3.28</td></tr> <tr><td>(-)</td><td>-0.28</td></tr> <tr><td>(-)</td><td>∞*0.28</td></tr> <tr><td>DEPT. 06</td><td>R-2.50</td></tr> <tr><td>DEPT. 06</td><td>R∞*2.50</td></tr> <tr><td colspan="2"> </td></tr> <tr><td>ITEMS</td><td>2Q</td></tr> <tr><td>CASH</td><td>*9.28</td></tr> </table> | DEPT. 06 | *12.50 | DEPT. 06 | ∞-12.50 | PLU. 0002 | *1.50 | PLU. 0002 | ∞-1.50 | DEPT. 08 | *6.00 | | 15.00% | %2 | *0.90 | %2 | ∞-0.90 | DEPT. 09 | *3.28 | (-) | -0.28 | (-) | ∞*0.28 | DEPT. 06 | R-2.50 | DEPT. 06 | R∞*2.50 | | | ITEMS | 2Q | CASH | *9.28 |
| DEPT. 06 | *12.50 | | | | | | | | | | | | | | | | | | | | | | | | | | | | | | | | |
| DEPT. 06 | ∞-12.50 | | | | | | | | | | | | | | | | | | | | | | | | | | | | | | | | |
| PLU. 0002 | *1.50 | | | | | | | | | | | | | | | | | | | | | | | | | | | | | | | | |
| PLU. 0002 | ∞-1.50 | | | | | | | | | | | | | | | | | | | | | | | | | | | | | | | | |
| DEPT. 08 | *6.00 | | | | | | | | | | | | | | | | | | | | | | | | | | | | | | | | |
| | 15.00% | | | | | | | | | | | | | | | | | | | | | | | | | | | | | | | | |
| %2 | *0.90 | | | | | | | | | | | | | | | | | | | | | | | | | | | | | | | | |
| %2 | ∞-0.90 | | | | | | | | | | | | | | | | | | | | | | | | | | | | | | | | |
| DEPT. 09 | *3.28 | | | | | | | | | | | | | | | | | | | | | | | | | | | | | | | | |
| (-) | -0.28 | | | | | | | | | | | | | | | | | | | | | | | | | | | | | | | | |
| (-) | ∞*0.28 | | | | | | | | | | | | | | | | | | | | | | | | | | | | | | | | |
| DEPT. 06 | R-2.50 | | | | | | | | | | | | | | | | | | | | | | | | | | | | | | | | |
| DEPT. 06 | R∞*2.50 | | | | | | | | | | | | | | | | | | | | | | | | | | | | | | | | |
| | | | | | | | | | | | | | | | | | | | | | | | | | | | | | | | | | |
| ITEMS | 2Q | | | | | | | | | | | | | | | | | | | | | | | | | | | | | | | | |
| CASH | *9.28 | | | | | | | | | | | | | | | | | | | | | | | | | | | | | | | | |

2 Correction of the Next-to-last or Earlier Entry (indirect void)

You can void any incorrect department entry, PLU/subdepartment entry or item refund entry made during a transaction if you find it before finalizing the transaction (e.g. pressing the [TL] key). This function is applicable to department, PLU/subdepartment and refund entries only.

Press the ∞ key just before you press a department key, [DEPT#] key, direct PLU key or [PLU/SUB] key. For the refund indirect void, press the ∞ key after you press the [RF] key.

| Key operation example | Receipt print | | | | | | | | | | | | | | | | | | | | | | | | | | | | | | |
|--|---|----------|--------|----------|--------|-----------|-------|-----------|-------|-----------|-------|----------|--------|----------|-------|----------|---------|----------|---------|-----------|--------|-----------|--------|----------|---------|--|--|-------|----|-------------|---------------|
| 1310 [6] 7 [DEPT#] 1755 [DEPT#] [10] [9] [12] 250 [RF] [6] [3] 825 [3] 1310 [∞] [6] 7 [∞] [DEPT#] 1755 [DEPT#] [9] [12] 250 [RF] [∞] [6] [TL] | <table border="0" style="width: 100%;"> <tr><td>DEPT. 06</td><td>*13.10</td></tr> <tr><td>DEPT. 07</td><td>*17.55</td></tr> <tr><td>PLU. 0010</td><td>*7.15</td></tr> <tr><td>PLU. 0009</td><td>*3.50</td></tr> <tr><td>PLU. 0012</td><td>*3.60</td></tr> <tr><td>DEPT. 06</td><td>R-2.50</td></tr> <tr><td>DEPT. 03</td><td>*8.25</td></tr> <tr><td>DEPT. 06</td><td>∞-13.10</td></tr> <tr><td>DEPT. 07</td><td>∞-17.55</td></tr> <tr><td>PLU. 0009</td><td>∞-3.50</td></tr> <tr><td>PLU. 0012</td><td>∞-3.60</td></tr> <tr><td>DEPT. 06</td><td>R∞*2.50</td></tr> <tr><td colspan="2"> </td></tr> <tr><td>ITEMS</td><td>2Q</td></tr> <tr><td>CASH</td><td>*15.40</td></tr> </table> | DEPT. 06 | *13.10 | DEPT. 07 | *17.55 | PLU. 0010 | *7.15 | PLU. 0009 | *3.50 | PLU. 0012 | *3.60 | DEPT. 06 | R-2.50 | DEPT. 03 | *8.25 | DEPT. 06 | ∞-13.10 | DEPT. 07 | ∞-17.55 | PLU. 0009 | ∞-3.50 | PLU. 0012 | ∞-3.60 | DEPT. 06 | R∞*2.50 | | | ITEMS | 2Q | CASH | *15.40 |
| DEPT. 06 | *13.10 | | | | | | | | | | | | | | | | | | | | | | | | | | | | | | |
| DEPT. 07 | *17.55 | | | | | | | | | | | | | | | | | | | | | | | | | | | | | | |
| PLU. 0010 | *7.15 | | | | | | | | | | | | | | | | | | | | | | | | | | | | | | |
| PLU. 0009 | *3.50 | | | | | | | | | | | | | | | | | | | | | | | | | | | | | | |
| PLU. 0012 | *3.60 | | | | | | | | | | | | | | | | | | | | | | | | | | | | | | |
| DEPT. 06 | R-2.50 | | | | | | | | | | | | | | | | | | | | | | | | | | | | | | |
| DEPT. 03 | *8.25 | | | | | | | | | | | | | | | | | | | | | | | | | | | | | | |
| DEPT. 06 | ∞-13.10 | | | | | | | | | | | | | | | | | | | | | | | | | | | | | | |
| DEPT. 07 | ∞-17.55 | | | | | | | | | | | | | | | | | | | | | | | | | | | | | | |
| PLU. 0009 | ∞-3.50 | | | | | | | | | | | | | | | | | | | | | | | | | | | | | | |
| PLU. 0012 | ∞-3.60 | | | | | | | | | | | | | | | | | | | | | | | | | | | | | | |
| DEPT. 06 | R∞*2.50 | | | | | | | | | | | | | | | | | | | | | | | | | | | | | | |
| | | | | | | | | | | | | | | | | | | | | | | | | | | | | | | | |
| ITEMS | 2Q | | | | | | | | | | | | | | | | | | | | | | | | | | | | | | |
| CASH | *15.40 | | | | | | | | | | | | | | | | | | | | | | | | | | | | | | |

Correction of a department entry {
 Correction of a subdept. entry →
 Correction of a PLU entry →
 Correction of a refund entry →

3 Subtotal Void

You can void an entire transaction. Once subtotal void is executed, the transaction is aborted and the register issues a receipt. This function does not work when more than 30 items have been entered.

Key operation example

1310

1755

Subtotal void {

Receipt print

| | |
|-----------|--------|
| DEPT. 02 | *13.10 |
| DEPT. 02 | *13.10 |
| DEPT. 06 | *17.55 |
| PLU. 0010 | *7.15 |
| PLU. 0035 | *10.00 |
| SUBTOTAL | *60.90 |
| SBTL ∞ | -60.90 |
| ***TOTAL | *0.00 |

4 Correction of Incorrect Entries not Handled by the Direct or Indirect Void Function

Any errors found after the entry of a transaction has been completed or during an amount tendered entry cannot be voided. These errors must be corrected by the manager.

The following steps should be taken:

1. If making the amount tendered entry, finalize the transaction.
2. Make correct entries from the beginning.
3. Hand the incorrect receipt to the manager for its cancellation.

PRIOR TO PROGRAMMING

Before starting sales entries, you must first program necessary items so the cash register suits your sales needs. In this manual, there are three sections, **BASIC FUNCTION PROGRAMMING where required items must be programmed**, **AUXILIARY FUNCTION PROGRAMMING** where you can program for more convenient use of keys on the keyboard, and **ADVANCED FUNCTION PROGRAMMING** where various optional programming features are provided. Find the appropriate features for your needs, and make the necessary programming.

Note You can select the language of text (English, German, French or Spanish) printed on receipts or journals. For the language selection, please refer to “Language Selection” described later in this section.

■ Procedure for programming

1. Check to see whether a paper roll is present in the machine. If there is not enough paper on a roll, replace it with a new one (refer to MAINTENANCE section for the replacement).
2. Put the manager key in the mode switch and turn it to the PGM position.
3. Program necessary items into the cash register.
Every time you program an item, the cash register will print the setting. Please refer to print samples in each section.
4. If necessary, issue programming reports for your reference.

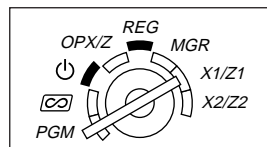

Note

- On the key operation example shown in the programming details, numbers such as “26082003” indicates the parameter which must be entered using the corresponding numeric keys.
- Asterisks in the tables shown in the programming details indicate default settings.

■ Guidance messages

Depending on programming items, the register shows guidance messages on the upper line of the operator display to indicate a programming item you are in, or guidance to enter data, as shown in the examples below. For direct PLU key programming, your register allows to program all necessary data in one procedure with the guidance messages. For guidance messages for direct PLU keys, please refer to “Direct PLU key programming” section.

Example 1: For key entry type programming

| Key operation example | Operator display |
|--|--|
| Parameter/price entry → 1000083 ⊗ (In case of parameter entry) | <div style="border: 1px solid black; padding: 5px; width: fit-content;">PGM 1000083</div> |
| Press of the subjected key → 1 • Guidance message is displayed. | <div style="border: 1px solid black; padding: 5px; width: fit-content;">DEPT FUNCTION 0.00</div> <p>Guidance message</p> |
| To terminate → TL | <div style="border: 1px solid black; padding: 5px; width: fit-content;">PGM 0.00</div> |

To repeat (depending on programming)

Guidance message is kept displaying until you press the TL key.

Example 2: For department code/PLU code entry type programming

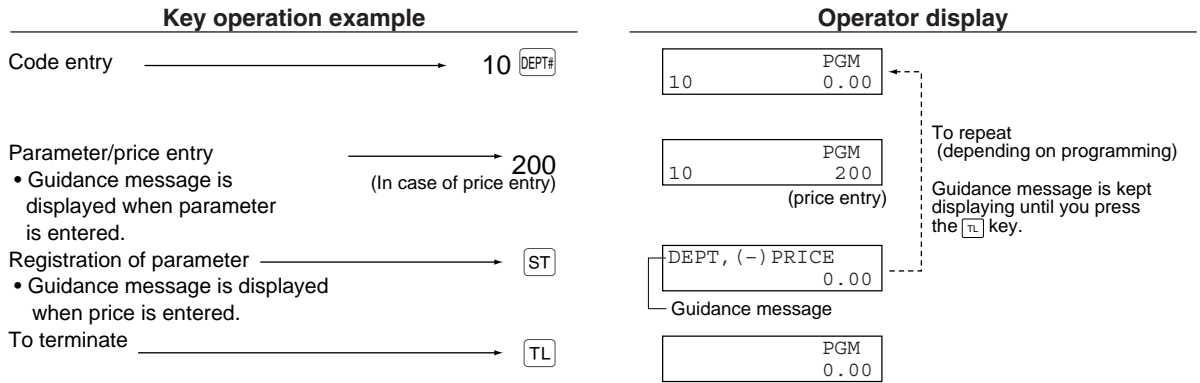

Example 3: Job code type programming (programming starting from the press of ST.)

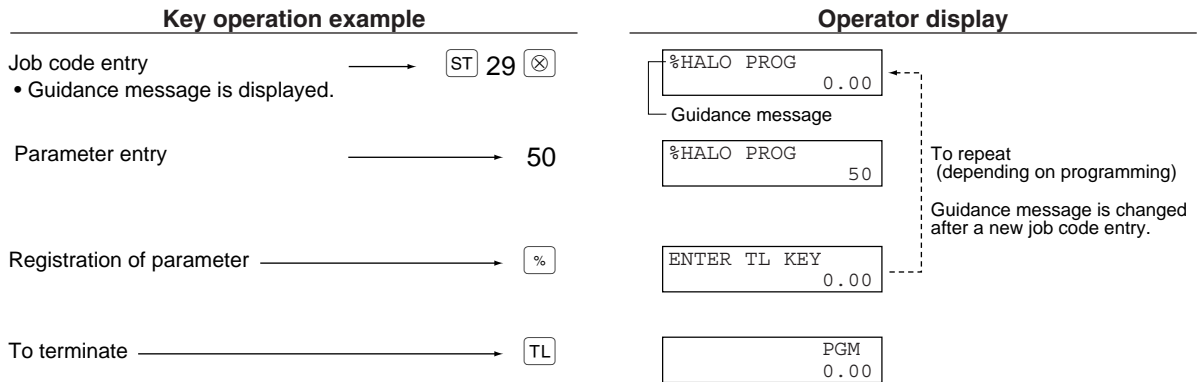





■ Guidance for text programming

The register allows you to program text for clerk names, department item names, PLU/subdepartment item names, if necessary. When you program texts, place the keyboard sheet for text programming over the keyboard sheet for ordinal use. For the placement, please refer to “Keyboard sheet” section on page 6. There are two ways for programming text; using character keys (shaded area shown below on the keyboard sheet for text programming) or entering character codes with numeric keys on the keyboard.

Keyboard sheet for text programming

| | | | | | | | | | | | | | | | | | |
|---------|-------|---|----|----|----|----|---------|---------|---------|---------|---------|---------|---------|---------|---------|--------------|---------|
| ↑ | (ESC) | â | à | á | ê | è | é | î | ì | í | ô | ò | ó | À | Ñ | (BACK SPACE) | |
| Æ | ø | û | ù | ú | ! | ? | # | \$ | % | & | ' | ^ | © | Ç | □ | = | |
| Pt | œ | ⊗ | • | CL | 1 | 2 | 3 | 4 | 5 | 6 | 7 | 8 | 9 | 0 | { } | [] | |
| § | £ | 7 | 8 | 9 | Q | W | E | R | T | Y | U | I | O | P | @ | / - | |
| () | 4 | 5 | 6 | A | S | D | F | G | H | J | K | L | ß | ; | + | * | |
| “ ” | 1 | 2 | 3 | Z | X | C | V | B | N | M | Ä | Ö | Ü | < | > | , | . |
| (SHIFT) | (DC) | 0 | 00 | | ST | TL | (SPACE) | (SPACE) | (SPACE) | (SPACE) | (SPACE) | (SPACE) | (SPACE) | (SPACE) | (SPACE) | (DC) | (SHIFT) |

Please note that the character keys used for entering numbers (shaded area) are different from numeric keys. The following are used as control keys for text programming.

-  Toggles between upper-case and lower-case letters. By default, the upper-case letter is selected. Once the  key is pressed, you are locked in for entering lower-case letters. “a” is displayed when lower-case letters entry is selected as shown in the operator display example below.
-  Toggles between single-size and double-size characters. By default, the single-size character is selected. Once the  key is pressed, you are locked in for entering double size characters. “W” is displayed when double-size characters entry is selected as shown in the operator display example below.
-  Backs up the cursor, erasing the character to the left.

Using character keys (Keys on the shaded area)

To enter numerals, letters and symbols, simply press the corresponding character on the shaded area on the keyboard.

Operator display (Example)

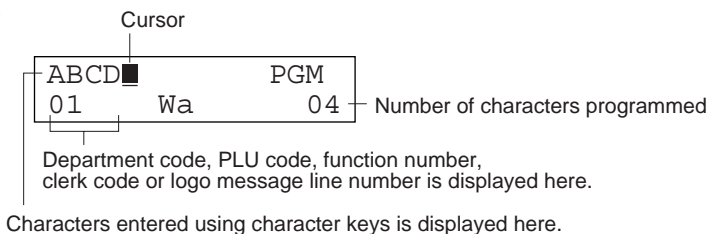

Example

To program the word "Clerk01" with the letter "C" being double size.

To make the letter "C" double size character

(DC) C

| | |
|---------|-----|
| =C | PGM |
| 01 W 02 | |

To make character size return to normal size

(DC)

| | |
|-------|-----|
| =C | PGM |
| 01 02 | |

To toggle the characters to lower-case letters

(SHIFT)

| | |
|---------|-----|
| =C | PGM |
| 01 a 02 | |

L E R K 0 1

| | |
|----------|-----|
| =Clerk01 | PGM |
| 01 a 08 | |

Entering character codes with numeric keys on the keyboard

To enter a numeral, letter or symbol, enter a character code using numeric keys and press the numeric key **00**. For the character codes, please refer to the alphanumeric character code table on the next page. Be doing this, you can program characters other than those on the key tops.

- Double-size characters can be made by entering the character code 253 or pressing the (DC) key. "W" is displayed when double-size characters entry is selected as shown in the operator display example below.
- All three digits of the character code MUST be entered (even if it starts with zero).

Operator display (Example)

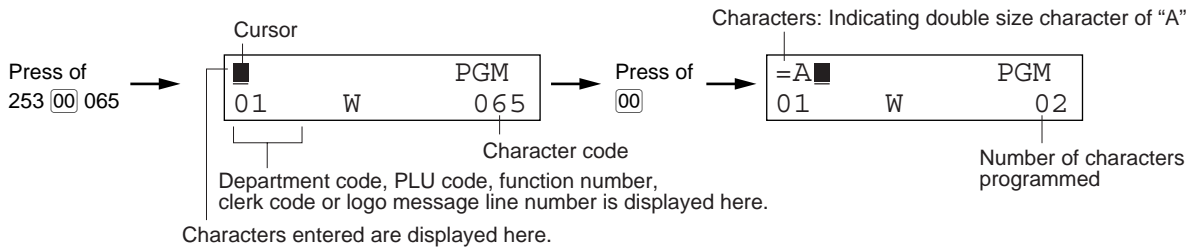

Example

To program the word "SHARP" in double-size characters

253 **00** 083 **00** 072 **00** 065 **00** 082 **00** 080 **00**
 S H A R P

Alphanumeric character code table

| Code | Character | Code | Character | Code | Character | Code | Character | Code | Character |
|------|-----------|------|-----------|------|-----------|------|-----------|------|-----------|
| 001 | á | 046 | . | 091 | Ä | 136 | → | 193 | ı |
| 002 | â | 047 | / | 092 | Ö | 137 | ſ | 194 | Ġ |
| 003 | ê | 048 | 0 | 093 | Ü | 138 | ſ | 195 | Ş |
| 004 | î | 049 | 1 | 094 | ^ | 139 | ◀ | 196 | Ĝ |
| 005 | ì | 050 | 2 | 095 | _ | 140 | ▶ | 197 | ġ |
| 006 | í | 051 | 3 | 096 | ' | 141 | F | 198 | Ɔ |
| 007 | ô | 052 | 4 | 097 | a | 142 | T | 199 | ƙ |
| 008 | ó | 053 | 5 | 098 | b | 143 | ↓ | 200 | ł |
| 009 | û | 054 | 6 | 099 | c | 144 | ç | 201 | ĵ |
| 010 | ú | 055 | 7 | 100 | d | 145 | ° | 202 | ž |
| 011 | œ | 056 | 8 | 101 | e | 146 | ı | 203 | Đ |
| 012 | ů | 057 | 9 | 102 | f | 147 | ù | 204 | đ |
| 013 | ů | 058 | : | 103 | g | 148 | à | 205 | Č |
| 014 | ř | 059 | ; | 104 | h | 149 | Æ | 206 | č |
| 015 | ó | 060 | < | 105 | i | 150 | ø | 207 | € |
| 016 | Λ | 061 | = | 106 | j | 151 | Å | 208 | Ɔ |
| 017 | Ψ | 062 | > | 107 | k | 152 | ¤ | 209 | ˘ |
| 018 | Γ | 063 | ? | 108 | l | 153 | é | 210 | ě |
| 019 | ˘ | 064 | @ | 109 | m | 154 | è | 211 | š |
| 020 | Ω | 065 | A | 110 | n | 155 | Pt | 212 | č |
| 021 | Δ | 066 | B | 111 | o | 156 | i | 213 | ž |
| 022 | Θ | 067 | C | 112 | p | 157 | Ñ | 214 | ý |
| 023 | Ξ | 068 | D | 113 | q | 158 | ò | 215 | ù |
| 024 | Π | 069 | E | 114 | r | 159 | £ | 216 | ň |
| 025 | Σ | 070 | F | 115 | s | 160 | ¥ | 217 | ˘ |
| 026 | Υ | 071 | G | 116 | t | 161 | ◦ | 218 | ˘ |
| 027 | Φ | 072 | H | 117 | u | 162 | Γ | 219 | ř |
| 028 | Ú | 073 | I | 118 | v | 163 | ┘ | 224 | * |
| 029 | Ú | 074 | J | 119 | w | 164 | ˘ | 225 | § |
| 030 | Ö | 075 | K | 120 | x | 165 | ˘ | 226 | Ø |
| 031 | Ö | 076 | L | 121 | y | 177 | Å | 227 | ˘ |
| 032 | (space) | 077 | M | 122 | z | 178 | í | 228 | ↑ |
| 033 | ! | 078 | N | 123 | { | 180 | Ā | 229 |] |
| 034 | " | 079 | O | 124 | | 181 | ā | 230 | [|
| 035 | # | 080 | P | 125 | } | 182 | Ē | 231 | " |
| 036 | \$ | 081 | Q | 126 | ß | 183 | ē | 232 | ä |
| 037 | % | 082 | R | 127 | ¢ | 184 | ī | 233 | ö |
| 038 | & | 083 | S | 128 | !! | 185 | ī | 234 | ü |
| 039 | ' | 084 | T | 129 | ₁ | 186 | ū | 235 | æ |
| 040 | (| 085 | U | 130 | ₂ | 187 | ū | 236 | â |
| 041 |) | 086 | V | 131 | ₃ | 188 | Ŋ | 237 | É |
| 042 | * | 087 | W | 132 | ₄ | 189 | ŋ | 238 | ň |
| 043 | + | 088 | X | 133 | 1/2 | 190 | Č | 253 | *(DC) |
| 044 | , | 089 | Y | 134 | Fₜ | 191 | Š | | |
| 045 | - | 090 | Z | 135 | ← | 192 | Č | | |

*(DC): Double-size character code

 : The shaded character cannot be displayed (displayed as space).

Note The character "!!" (code 128) cannot be displayed (displayed as "!").

BASIC FUNCTION PROGRAMMING

(For Quick Start)

1 Date and Time Programming

■ Date

For setting the date, enter the date in 8 digits using the day-month-year (DD/MM/YYYY) format, then press the **#** key.

Procedure

Date(DD/MM/YYYY) → **#**

Key operation example

26082003 **#**
(26 Aug., 2003)

Print

PGM
26/08/2003 — Date

Note

You can use the date format of month-day-year (MM/DD/YYYY) or year-month-day (YYYY/MM/DD) format. To change the format, refer to "Various Function Selection Programming 1" section (Job code 61).

■ Time

For setting the time, enter the time in 4 digits using the 24-hour format. For example, when the time is set to 2:30 AM, enter 230; and when it is set to 2:30 PM, enter 1430.

Procedure

Time(max. 4 digits in 24-hour format) → **#**

Key operation example

1430 **#**

Print

PGM
14:30 — Time

Note

In the display, current time is displayed in 24-hour format. If you want to display time in the 12-hour format, refer to "Various Function Selection Programming 1" section (Job code 61).

2 Tax Programming

If you program the VAT/tax, the cash register can calculate the sales tax. In the VAT system, the tax is included in the price you enter in the register, and the tax amount is calculated when tendered according to the VAT rate programmed. In the tax system, the tax is calculated when tendered according to the tax rate programmed, and added to the price. The cash register can provide totally 6 kinds of VAT/tax systems (automatic VAT1-4, automatic tax 1-4, manual VAT 1-4, manual VAT 1, manual tax 1-4, and automatic VAT1 and automatic tax 2-4 systems) and 4 kinds of rates. By default, the cash register is pre-programmed as automatic VAT1-4 system.

When you program tax rate(s) and taxable status for each department (by default, VAT1/tax1 is set to taxable.), tax will be automatically added to sales of items assigned to the department according to the programmed tax status for the department and the corresponding tax rate(s).

For details of the tax systems, refer to “Computation of VAT (Value Added Tax)/tax” section on page 20. To change the tax system, please refer “Other programming” of “Various Function Selection Programming 1” section (Job code 69) on page 55.

■ Tax rate programming

The percent rate specified here is used for tax calculation on taxable subtotals.

Procedure

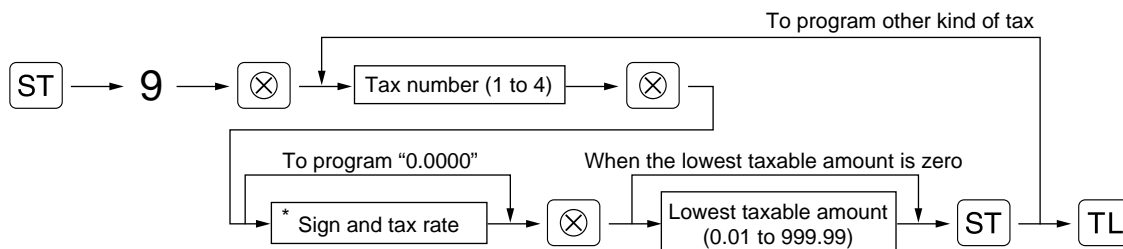

*Sign and tax rate: X YYY.YYYY

Tax rate=0.0000 to 100.0000
Sign -/+ = 1/0

For entering tax number, sign and tax rate and lowest taxable amount, the register displays guidance messages, ENTER TAX NO., ENTER TAX RATE, and ENTER LOWER TAX respectively.

Key operation example

ST 9 ⊗
2 ⊗
4 ⊗
12 ST
TL

Print

```
*PGM*
T2          4.0000%
              0.12
```

Note

- The lowest taxable amount is valid only when you select add on tax system. If you select VAT (Value added system), it is ignored.
- If you make an incorrect entry before pressing the third ⊗ key in programming a tax rate, cancel it with the CL key.
- You do not need to enter the trailing zeros of the tax rate (after the decimal point), but you do need to enter the decimal for fractions.
- If you select VAT system, the sign which you program is ignored.

To delete a tax rate, use the following sequence:

Procedure

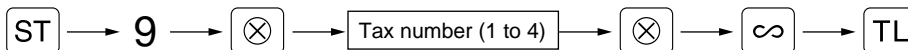

AUXILIARY FUNCTION PROGRAMMING

1 Department Programming

Merchandise can be classified into a maximum of 50 departments. Items sold using the department keys can later be printed on a report shown as the quantities sold and sales amounts classified by department. The data is useful for making purchasing decisions and other store operations.

■ Department status

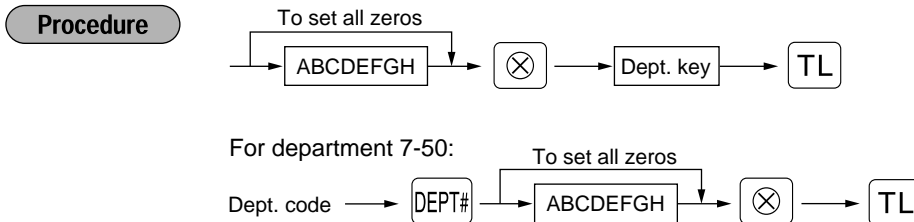

To program another department, start from the beginning without pressing the **TL** key.

| Item: | Selection: | Entry: |
|-----------------------------------|------------------------|-----------------|
| A VAT 4 or tax 4 status | Taxable | 1 |
| | Non-taxable* | 0 |
| B VAT 3 or tax 3 status | Taxable | 1 |
| | Non-taxable* | 0 |
| C VAT 2 or tax 2 status | Taxable | 1 |
| | Non-taxable* | 0 |
| D VAT 1 or tax 1 status | Taxable* | 1 |
| | Non-taxable | 0 |
| E SICS / Normal | SICS | 1 |
| | Normal* | 0 |
| F Sign | Negative department | 1 |
| | Positive department* | 0 |
| G Entry digit limit | | 0-8 (default:8) |
| H Type of unit price entry | Open and preset | 3 |
| | Preset only | 2 |
| | Open only* | 1 |
| | Inhibit department key | 0 |

VAT/tax status (taxable 1 through 4 / non-taxable)

- When any entry of a taxable department is made in a transaction, tax is automatically computed according to the associated tax rate as soon as the transaction is completed.
By default, VAT 1 is assigned for all departments.

SICS (Single Item Cash Sale)

- If an entry of a department programmed for SICS is made first, the sale will be finalized as a cash sale as soon as the department key is pressed. If the entry is made after entering a department not programmed for SICS, the sale will not be finalized until the **TL** key is pressed.

Entry digit limit

- Set the number of allowable digits for the maximum entry amount for each department. The limit is effective for operations in the REG mode and can be overridden in the MGR mode.

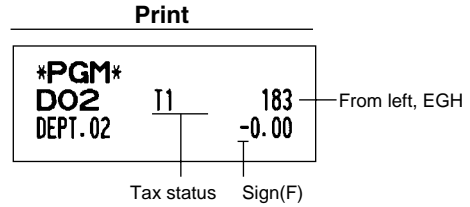
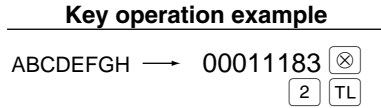

■ Preset unit price

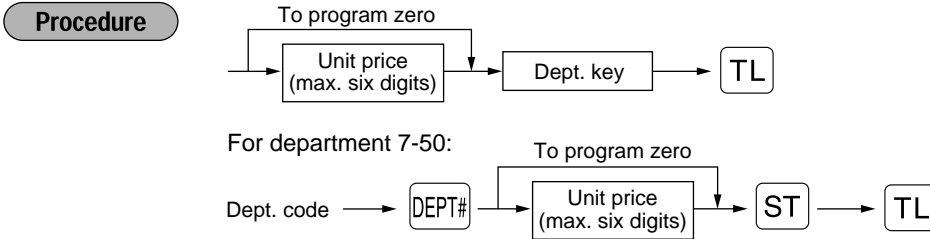

To program another department, start from the beginning without pressing the key.

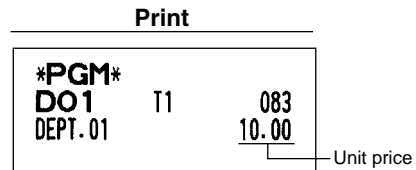
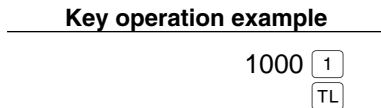

Note If a department is not programmed to allow the entry of preset unit prices in functional programming, the department is automatically changed to allow the entry of preset unit prices by this programming entry.

2 PLU (Price Look-Up) and Subdepartment Programming

The PLU function allows speedy key entries whereby a price is automatically called up when a direct PLU key is pressed or a code is entered. The subdepartment is a kind of “open PLU”, which requires you to enter a price before the direct PLU key is pressed or after the PLU code is entered. A maximum of 1200 PLU/subdepartment settings are possible. Each one belongs to a department and acquires the department’s parameters (tax status, sign, SICS and entry digit limit).

By default, PLU/subdepartment setting for 1 through 210 codes are available and they are assigned as positive PLUs associated with department 1 and preset unit price “0”.

To extend the number of PLUs/subdepartments, please refer to “EJ memory type” on page 57.

■ Direct PLU key programming (For PLU code 1 to 210)

Your machine provides 70 direct PLU keys (through) and three PLU level shift keys () to provide three levels for each direct PLU key. PLU codes 1 through 70 are allocated for level 1, PLU codes 71 through 140 for level 2 and PLU codes 141 through 210 for level 3. For example, for key, PLU1 for level 1, PLU 71 for level 2 and PLU 141 for level 3 are assigned.

- thru corresponds to PLU codes 1 through 70 respectively.
- thru corresponds to PLU codes 71 through 140 respectively.
- thru corresponds to PLU codes 141 through 210 respectively.

For easier programming for the direct PLU keys, the register especially allows you to program all parameters in one procedure according to guidance messages displayed on the upper line of operator display, while you can program parameters individually. (For these individual programming methods, please refer to next two sections and “PLU text (item label)” on page 44.)

Follow the procedure shown below for direct key programming:

Procedure

Note

- To keep current setting on each programming, press the **[ST]** key when the corresponding guidance message is firstly displayed.
- When pressing the **[TL]** key in the middle of procedure, the programming will terminate and the data you entered before the press of **[TL]** is saved.

1. Specify the direct PLU key and its level.

- Press a level shift key and a direct PLU key in this order.
Immediately after displaying the current text setting, guidance message for the next step will be displayed on the upper line and the corresponding PLU key code you entered will be displayed on the lower line.

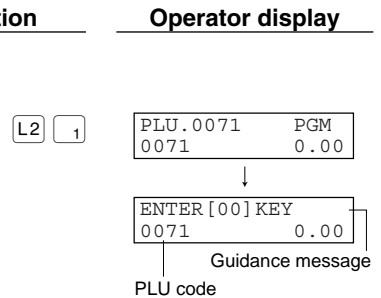

When you press a direct PLU key without pressing a level shift key, level 1 is automatically selected.

2. Text programming (Press **[ST]** to skip)

- Press **[00]** key to enter text programming.
The text data currently set will be displayed on the upper line.
- Enter an item name.
A maximum of 16 characters can be entered.
Please refer to “Guidance for text programming” for entering the item name.
When you start entering a character, the current text data will be overwritten by new data.
- Press the **[ST]** key to register the item name.
Guidance message for the next step will be displayed.

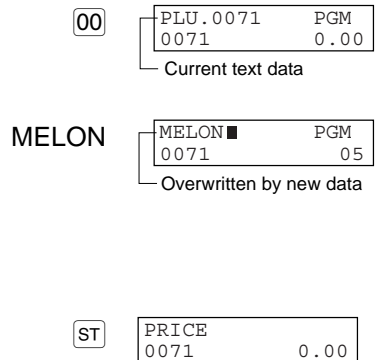

3. Unit price programming (Press **[ST]** to skip)

- Enter a unit price using numeric keys.
A maximum of 6 digits can be set.
For a subdepartment, set the limit amount of unit price entry.
- Press the **[ST]** key to register the unit price.
Guidance message for the next step will be displayed.

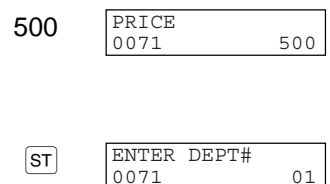

4. Associated dept. programming (Press **ST** to skip)

- Enter a associated dept. code using numeric key.
For dept. 1 through 6, you may press the corresponding department key.

1

| | |
|-------------|---|
| ENTER DEPT# | |
| 0071 | 1 |

- Press the **ST** key to register the associated dept. code.
Guidance message for the next step will be displayed.

ST

| | |
|----------------|---|
| ENTER PLU TYPE | |
| 0071 | 1 |

5. Function programming (Press **ST** to skip)

- Press 1 when using the PLU code as PLU, or 0 when using as subdepartment.

1

| | |
|----------------|---|
| ENTER PLU TYPE | |
| 0071 | 1 |

- Press the **ST** key to register the setting.
The PLU code is automatically incremented for a new direct PLU key programming, and ready for text programming for the incremented PLU code.

ST

| | |
|----------------|------|
| ENTER [00] KEY | |
| 0072 | 0.00 |

To program for the incremented PLU code, return to the step 2.

When you want to program for other than incremented PLU code, return to the step 1.

6. Terminate programming

- Press the **TL** key to terminate direct PLU key programming.

TL

| | |
|------|--|
| PGM | |
| 0.00 | |

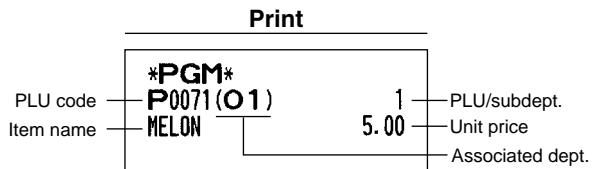

■ Unit price and associated department assignment

Procedure

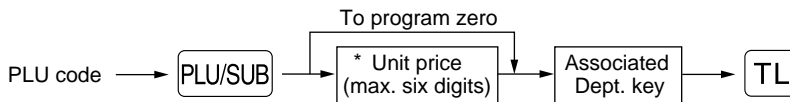

When the associated department is department 7-50:



*: For a subdepartment, set the limit amount of unit price entry.

To program the following PLU code, start from entering a unit price or an associated department code without pressing the **TL** key.

To program another PLU code, start from the beginning without pressing the **TL** key.

Key operation example

200
 125

Print

| | |
|------------|------|
| *PGM* | |
| P0200 (03) | 1 |
| PLU. 0200 | 1.25 |

Unit price
 Associated dept.
 PLU code

To delete a PLU code, use the following sequence:

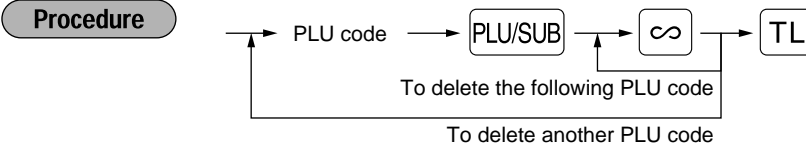

PLU/subdepartment selection

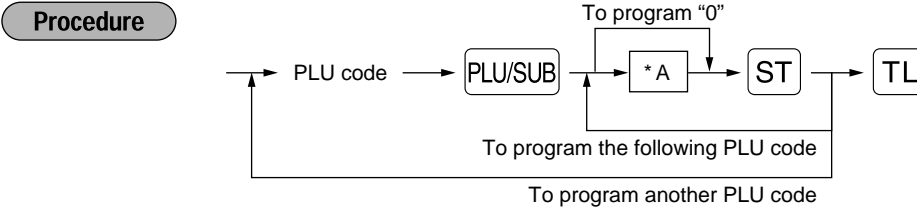

*A: 0 for subdepartment or 1 for PLU

Key operation example

200
 0

Print

| | |
|------------|------|
| *PGM* | |
| P0200 (03) | 0 |
| PLU. 0200 | 1.25 |

PLU/subdept.

Note When you program the last PLU code, the programming sequence will be complete with a press of the key.

3 Miscellaneous Key Programming

The cash register provides miscellaneous keys such as , , , , , , , , and .

Rate for and

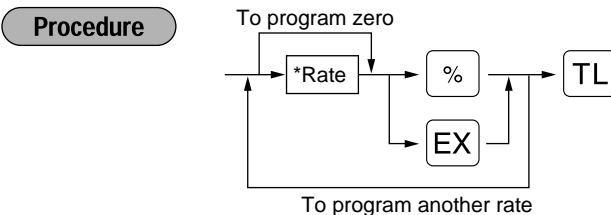

*: Rate

0.00 — 100.00 (% rate)

0.000000 — 999.999999 (Currency exchange rate)

Key operation example

10 \cdot 25 $\%$
 0 \cdot 939938 EX
 TL

Print

| | |
|-----------|----------|
| *PGM* | |
| F02 % | 000 |
| L100.00% | -10.25% |
| F35 EXCH1 | 002 |
| | 0.939938 |

Percent rate
 Currency exchange rate

Note You must use a decimal point when setting fractional rates.

Amount for \ominus

Procedure

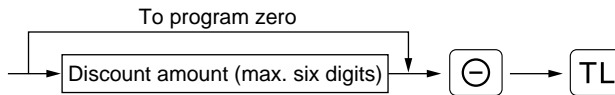

Key operation example

200 \ominus
 TL

Print

| | |
|---------|-------|
| *PGM* | |
| F01 (-) | 008 |
| | -2.00 |

Discount amount

Percent rate limitation for $\%$

You can program the upper limit of percent rate for percent entries.

Procedure

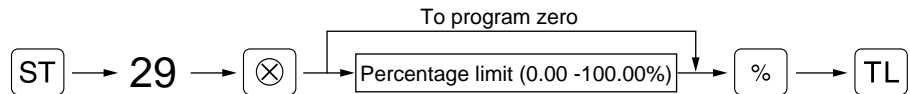

Note

- Percent entries that exceed the upper limit may be overridden in the MGR mode.
- You must use a decimal point when setting fractional rate.

Key operation example

ST 29 \otimes
 15 \cdot 00 $\%$
 TL

Print

| | |
|----------|---------|
| *PGM* | |
| F02 % | 000 |
| L 15.00% | -10.25% |

Percentage limit

Function parameters for $\%$ and \ominus

Procedure

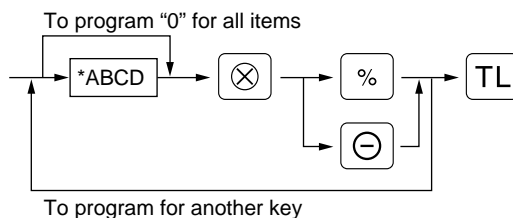

| *: Item: | Selection: | Entry: |
|---|--------------------|-----------------|
| A +/- sign | + (premium) sign | 0 |
| | - (discount) sign* | 1 |
| B Item % / Item ⊖ | Allow* | 0 |
| | Disallow | 1 |
| C Subtotal % / Subtotal ⊖ | Allow* | 0 |
| | Disallow | 1 |
| D Entry digit limit for discount key | | 0-8 (default:8) |

When programming for percent key, always enter 0 for D.

+/- sign

- Programming of the +/- sign assigns the premium or discount function for each key.

Item % / Item ⊖

- Percent/discount calculation for the individual department and PLU/subdepartment

Subtotal % / Subtotal ⊖

- Percent/discount calculation for the subtotals

Entry digit limit (For discount key only)

- The entry digit limit is in effect for the REG mode operations but can be overridden in the MGR mode. The entry digit limit is represented by the number of allowable digit for the maximum entry amount for discount key. When "0" is set, open price entry is prohibited.

Key operation example

1006 ⊗
⊖ TL

Print

```
*PGM*
F01 (-)      006
              -2.00
              Sign(A)
```

Function parameters for EX

Procedure

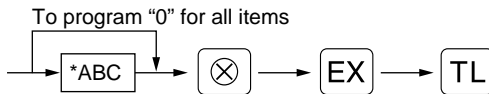

| *: Item: | Selection: | Entry: |
|---|------------|-----------------|
| A Open rate entry | Allow* | 0 |
| | Disallow | 1 |
| B Preset rate entry | Allow* | 0 |
| | Disallow | 1 |
| C Position of decimal point (from right) (tab) | | 0-3 (default:2) |

Key operation example

102 ⊗
EX TL

Print

```
*PGM*
F35 EXCH1   102
             0.939938
             From left, ABC
```

Function parameters for RA, PO, CH1, CH2, CR1, CR2 and TL

Procedure

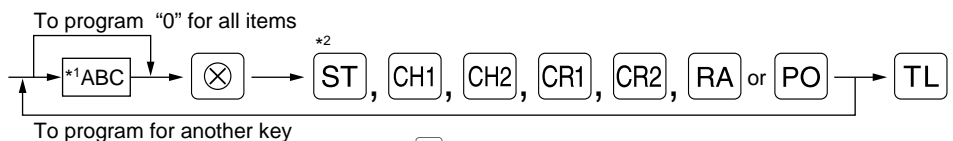

| *1:Item: | Selection: | Entry: |
|--------------------------|--|-----------------|
| A Footer printing* | Allow | 1 |
| | Disallow* | 0 |
| B Amount tendered entry* | Compulsory | 1 |
| | Non-compulsory (for <input type="checkbox"/> CH1, <input type="checkbox"/> CH2 and <input type="checkbox"/> TL)* | 0 |
| | Inhibit (for <input type="checkbox"/> CR1 and <input type="checkbox"/> CR2)* | 0 |
| C Entry digit limit | For <input type="checkbox"/> CH1, <input type="checkbox"/> CH2, <input type="checkbox"/> CR1, <input type="checkbox"/> CR2 and <input type="checkbox"/> TL | 0-8 (default:8) |
| | For <input type="checkbox"/> RA and <input type="checkbox"/> PO | 0-9 (default:9) |

*When programming for RA or PO, always enter 0 for A and B.

Footer printing (only for CH1, CH2, CR1, CR2 and TL)

- This programming decides whether or not the machine should print a message at the foot of a receipt when a specified media key is used. With regard to programming method of footer logo message, refer to “Logo messages” section on page 46.

Amount tendered entry (only for CH1, CH2, CR1, CR2 and TL)

- You may select amount tendered, compulsory or optional, for the TL, CH1 and CH2 keys.
- You may select amount tendered, compulsory or inhibited, for the CR1 and CR2 keys.

Entry digit limit

- For the CH1, CH2, CR1, CR2, RA and PO keys program upper limit entry amount for the tendered amount. For the TL key, program upper limit entry for total cash amount which can be handled on the register. The entry digit limit is in effect for REG mode operation but can be overridden in the MGR mode. The entry digit limit is represented by the number of allowable digits for the maximum entry or total amount. When “0” is set, the operation of the corresponding key is prohibited.

Key operation example

018
 CH1 TL

Print

PGM
 F31 CHECK1 018 —From left, ABC

4 Text Programming

The register allows you to program texts for department item names, PLU/subdepartment item names, function texts, clerk names, logo messages, foreign and domestic currency symbols, and training mode texts. Please refer to “Guidance for text programming” on page 31 as for how to entering characters.

When you press an appropriate number key (job code number) and press the key for text entry just after you start programming with the ST key, the cash register will automatically be ready for text entry.

Then a little after displaying guidance message indicating what programming you are in, the register may ask you to enter the first parameter, such as dept. code. Referring to the corresponding “Procedure”, enter a parameter and start character entries.

■ Department text (item label) (16 digits)

Procedure

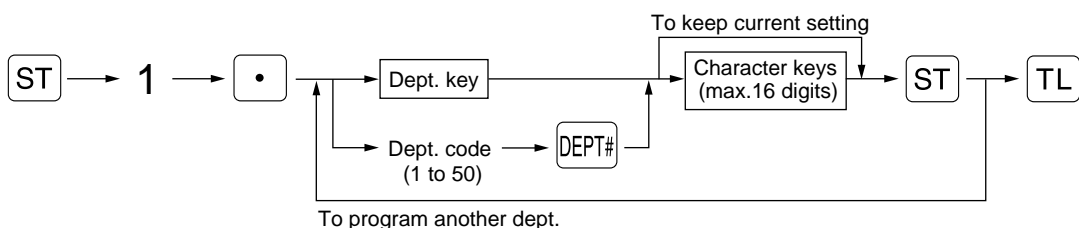

Key operation example

ST 1 •
1
FRUIT ST
TL

(Programming FRUIT for dept.1)

Print

```
*PGM*
DO1      T1      083
FRUIT    10.00
```

Text programmed for dept. 1

■ **PLU text (item label)** (16 digits)

Procedure

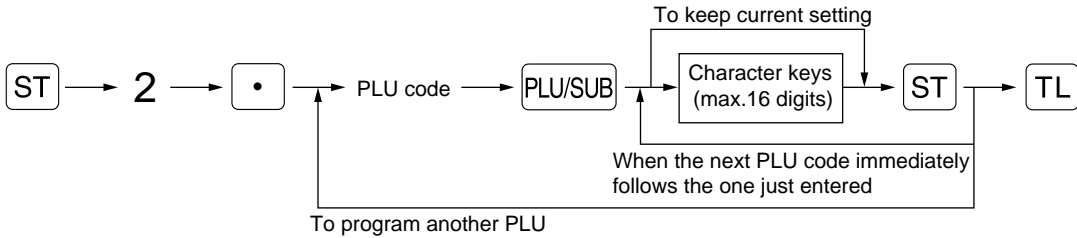

Key operation example

ST 2 •
3 PLU/SUB
APPLE ST
TL

(Programming APPLE to PLU3)

Print

```
*PGM*
P0003(O1)      1
APPLE          0.00
```

Text programmed for PLU code 3

■ **Function text** (12 digits)

Procedure

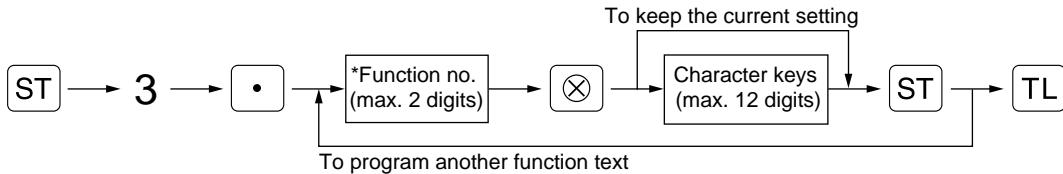

Function no.: See "List of function texts" shown on the next page.

Key operation example

ST 3 •
33 ⊗
CARD1 ST
TL

(Programming CARD1 for credit 1)

Print

```
*PGM*
F33 CARD1      008
```

■ List of function texts

| Function no. | Key or function | Default setting | Function no. | Key or function | Default setting |
|--------------|--------------------------|-----------------|--------------|-------------------------------|-----------------|
| 1 | ⊖ | (-) | 40 | Cash/cheque in drawer | CA/CH ID |
| 2 | % | % | 41 | Change for cheque | CHK/CG |
| 3 | Differ | DIFFER | 42 | Domestic currency 1 | DOM.CUR1 |
| 4 | Taxable 1 subtotal | TAX1 ST | 43 | Domestic currency 2 | DOM.CUR2 |
| 5 | Taxable 2 subtotal | TAX2 ST | 44 | Dom. currency for EX cheque | DOM.CUR1 |
| 6 | Taxable 3 subtotal | TAX3 ST | 45 | Dom. currency for EX credit | DOM.CUR1 |
| 7 | Taxable 4 subtotal | TAX4 ST | 46 | Cheque in drawer | *CH ID |
| 8 | VAT/tax 1 | VAT 1 | 47 | (+) Dept total | *DEPT TL |
| 9 | VAT/tax 2 | VAT 2 | 48 | (-) Dept total | DEPT (-) |
| 10 | VAT/tax 3 | VAT 3 | 49 | Net 1 (Taxable 1 - VAT/tax 1) | NET 1 |
| 11 | VAT/tax 4 | VAT 4 | 50 | Net 2 (Taxable 2 - VAT/tax 2) | NET 2 |
| 12 | Net 1 | NET1 | 51 | Net 3 (Taxable 3 - VAT/tax 3) | NET 3 |
| 13 | Net 2 | NET2 | 52 | Net 4 (Taxable 4 - VAT/tax 4) | NET 4 |
| 14 | Refund | REFUND | 53 | Subtotal | SUBTOTAL |
| 15 | Void | ∅ | 54 | Merchandise subtotal | MDSE ST |
| 16 | Void mode total | ∅ MODE | 55 | Total | *** TOTAL |
| 17 | Manager void | MGR ∅ | 56 | Change | CHANGE |
| 18 | Subtotal void | SBTL ∅ | 57 | Sales qty | ITEMS |
| 19 | Bill counter | BILL CNT | 58 | Due | DUE |
| 20 | No sale | NO SALE | 59 | Exchange (Preset rate) change | EX1 CHG |
| 21 | Previous balance | ***PBAL | 60 | Amount | AMOUNT |
| 22 | New balance | ***NBAL | 61 | Total tax | TTL TAX |
| 23 | Customer | GUEST | 62 | Old balance | OLD BAL. |
| 24 | Order total | ORDER TL | 63 | New balance | BALANCE |
| 25 | Paid total | PAID TL | 64 | Net without tax (on report) | NET |
| 26 | Average | AVE. | 65 | Department report title | DEPT |
| 27 | Order total – paid total | O-P | 66 | PLU report title | PLU |
| 28 | RA | ***RA | 67 | Transaction report title | TRANS. |
| 29 | PO | ***PO | 68 | Clerk report title | CLERK |
| 30 | Cash | CASH | 69 | Hourly report title | HOURLY |
| 31 | Cheque 1 | CHECK1 | 70 | GLU report title | GLU |
| 32 | Cheque 2 | CHECK2 | 71 | GLU code | GLU# |
| 33 | Credit 1 | CREDIT1 | 72 | Balance report title | BALANCE |
| 34 | Credit 2 | CREDIT2 | 73 | Non add symbol (8 chara.) | # |
| 35 | Exchange (Preset rate) | EXCH1 | 74 | Copy receipt title | COPY |
| 36 | Exchange (Open rate) | EXCH2 | 75 | Guest check receipt title | BILL |
| 37 | Exchange cheque | EX1 CHK | 76 | EJ report title | EJ |
| 38 | Exchange credit | EX1 CR | 77 | EJ report end title | EJ END |
| 39 | Cash in drawer | **** CID | | | |

■ Clerk names (12 digits)

Procedure

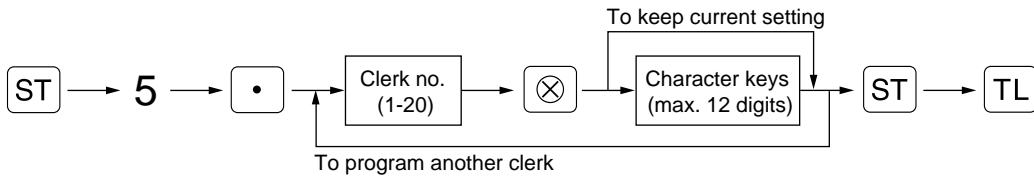

Key operation example



Print



■ Logo messages (6 lines and 24 digits for each line)

The register can print programmed messages on every receipt. On the standard model, a 6-line logo message is printed on the receipt. If you want to print in other logo message format, please change the format. (See page 56 for the programming details.) The options are listed below:

Procedure

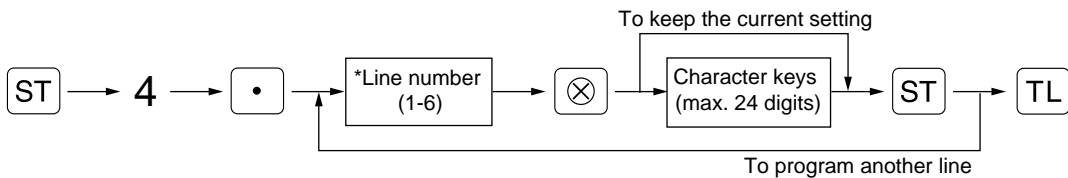

* "Header 3-line message" type: 1 to 3

"Header 6-line message" type: 1 to 6

"Header 3-line and footer 3-line message" type: 1 to 6 (1 to 3 as header, 4 to 6 as footer)

Logo message print format (3 types)

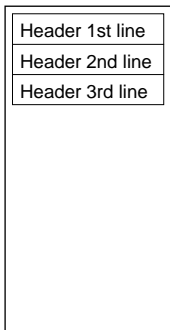

Header 3-line message

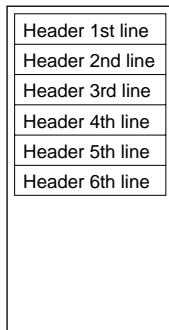

Header 6-line message
(Default setting)

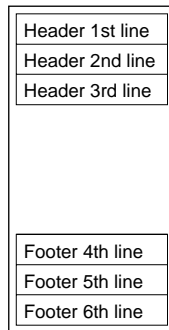

Header 3-line message and footer 3-line messages

To print the logo message “THANK YOU” using double sized characters and centering on the third line.

Key operation example

Print

PGM
THANK YOU

Note A 6-line logo message is preprogrammed when shipped. Please start entering from the first line when you first program a logo message.

Foreign currency symbol (4 digits)

Foreign currency symbol for the **EX** key is printed with a foreign currency exchange amount obtained using a preset rate.

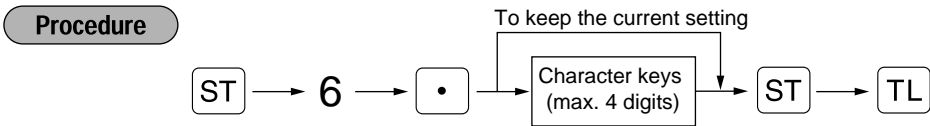

Key operation example

Print

PGM
F35 EXCH1 102
US \$ 0.939938

Foreign currency symbol

Domestic currency symbol (4 digits)

“*” is set as a default setting. When you want to change the domestic currency symbol, change the setting.

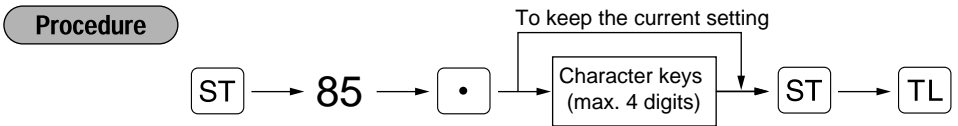

Key operation example

Print

PGM
#85 €

Domestic currency symbol

■ Training mode text (12 digits)

For every receipts issued in the training mode, ****TRAINING**** is printed by default. When you want to change the text, follow the procedure below.

Procedure

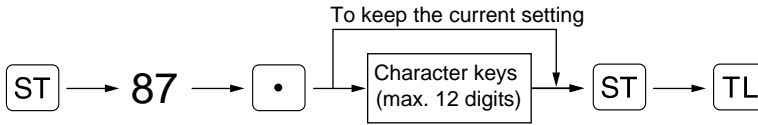

Key operation example



Print



Note

The programmed text is printed in double-size characters on the receipts issued in the training mode.

ADVANCED FUNCTION PROGRAMMING

1 Register Number and Consecutive Number Programming

The register number and consecutive numbers are printed on every receipt or journal.

When your store has two or more registers, it is practical to set separate register numbers for identification. The consecutive number is increased by one each time a receipt is issued or when a journal print occurs.

For consecutive number programming, enter a number (max. 4 digits) that is one less than the desired starting number.

■ Register number

Procedure

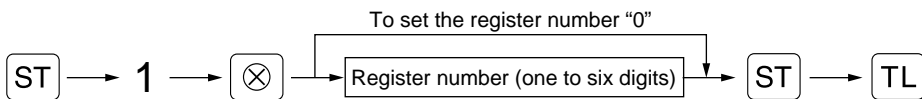

Key operation example



Print

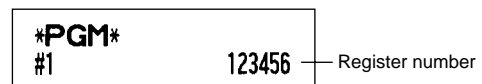

■ Consecutive number

Procedure

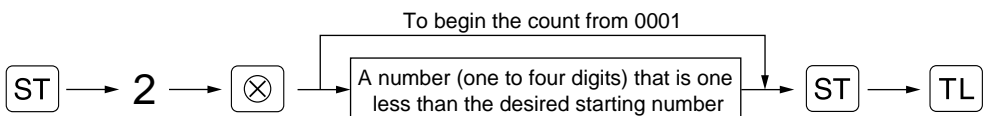

Key operation example

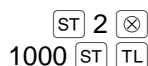

Print

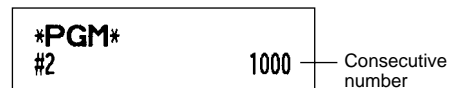

2 Various Function Selection Programming 1

The cash register provides various detailed functions listed below.

- Function selection for miscellaneous keys
- Print format
- Receipt print format
- PLU level shift and GLU function parameters
- Others

For this programming, the job code entry style is applied. You can continue programming until you press the **TL** key for the programming described in this section. To continue programming, repeat from a job code entry.

Procedure

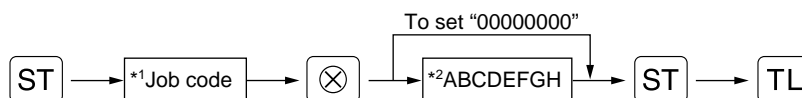

*1 Enter job code using numeric keys specified in each section below.

*2 Data entry details are listed on each table in each section below. An asterisk is entered for factory setting.

Example: When programming for job code 5 as ABCDEFGH: 00000100.

Key operation example

ST 5 ⊗
 00000100 ST TL

Print

PGM
#5 00000100

Function selection for miscellaneous keys

Job code: 5

| * Item: | Selection: | Entry: |
|--|---------------------------------|--------|
| A Paid-out in the REG mode | Enable* | 0 |
| | Disable | 1 |
| B Received on account in the REG mode | Enable* | 0 |
| | Disable | 1 |
| C Subtotal void in the REG mode | Enable* | 0 |
| | Disable | 1 |
| D Indirect void in the REG mode | Enable* | 0 |
| | Disable | 1 |
| E Direct void in the REG mode | Enable* | 0 |
| | Disable | 1 |
| F Refund entry in the REG mode | Enable* | 0 |
| | Disable | 1 |
| G No sale in the REG mode | Enable* | 0 |
| | Disable | 1 |
| H Fractional quantity entry | Enable (3 digits decimal place) | 0 |
| | Disable* | 1 |

■ Print format

Job code: 6

| * Item: | Selection: | Entry: |
|---------|--|------------------|
| A | Printing style | Journal printing |
| | | Receipt* |
| B | Receipt print style | Total |
| | | Detailed* |
| C | Time print on all receipts | Yes* |
| | | No |
| D | Date print on all receipts | Yes* |
| | | No |
| E | Consecutive no. print | Yes* |
| | | No |
| F | Separator line in reports | One line space |
| | | Separator line* |
| G | Zero skip in PLU report | No |
| | | Yes* |
| H | Zero skip in full sales/clerk/hourly reports | No |
| | | Yes* |

Printing style

- Even when receipt printing is selected, the journal rewind motor will be driven in PGM, OP X/Z, X1/Z1 and X2/Z2 modes so you can wind sales and programming reports.

■ Receipt print format

Job code: 7

| * Item: | Selection: | Entry: |
|---------|---|--------|
| A | Always enter 0. | 0 |
| B | Always enter 0. | 0 |
| C | Subtotal print with a press of subtotal key | No* |
| | | Yes |
| D | Always enter 0. | 0 |
| E | VAT/tax amount print | Yes* |
| | | No |
| F | Taxable amount print | Yes* |
| | | No |
| G | Net amount print | Yes* |
| | | No |
| H | Purchase no. print | Yes* |
| | | No |

■ PLU level shift and GLU function parameters

Job code: 15

| * Item: | Selection: | Entry: |
|---------|--|-------------------------------|
| A | PLU level shift mode | Automatic return mode* |
| | | Lock shift mode |
| B | PLU level shift operation availability | Available in MGR & REG modes* |
| | | Available in MGR mode |
| C | PLU level shift timing for returning to level 1 in automatic return mode | 1 item* |
| | | 1 transaction |
| D | Checking clerk code on guest check when a reorder is made | Yes |
| | | No* |
| E | Printing of previous and new balances on G.C. receipt | Yes |
| | | No* |
| F | Clearing details in GLU buffer at a press of INBAL | No* |
| | | Yes |
| G | Clearing details in GLU buffer at a press of GC RCPT | No |
| | | Yes* |
| H | Always enter 0. | 0 |

■ Other programming

Note

As the guidance messages for other programming, "OTHERS + the lower digit number of job code" is displayed. For example, for job code 61, "OTHERS 1" is displayed as the guidance message.

Job code: 61

| * Item: | Selection: | Entry: |
|---------|--|-----------------------------------|
| A | Always enter 0. | 0 |
| B | Always enter 0. | 0 |
| C | Negative dept. and PLU/subdept. | Disable |
| | | Enable* |
| D | Fractional treatment | Round off (4 down, 5 up)* |
| | | Raising to unit |
| | | Disregarding fractional treatment |
| E | Use of 00 key | As 00 key* |
| | | As 000 key |
| F | Time format | 12-hour format |
| | | 24-hour format* |
| G | Date format | Use month-day-year format |
| | | Use day-month-year format* |
| | | Use year-month-day format |
| H | Position of decimal point (from right) (TAB) | 0 to 3 (default: 2) |

Job code: 62

| * Item: | Selection: | Entry: |
|---------|---|---------------|
| A | Always enter 0. | 0 |
| B | Error beep for misoperation | Lock error |
| | | Misoperation* |
| C | Key catch sound | Yes* |
| | | No |
| D | Buffered keyboard | Yes* |
| | | No |
| E | Void mode | Enable* |
| | | Disable |
| F | Printing of void mode in X2/Z2 report | Yes* |
| | | No |
| G | Printing of void mode in X1/Z1 report | Yes* |
| | | No |
| H | Addition to the hourly total in VOID mode | No* |
| | | Yes |

Job code: 63

| * Item: | Selection: | Entry: |
|---------|--|----------------|
| A | Receipting at the time of "no sale" entry | Yes* |
| | | No |
| B | No sale after non-add code entry | Disable |
| | | Enable* |
| C | Non-add code entry | Enable* |
| | | Disable |
| D | Copy receipt | No* |
| | | Yes |
| E | Entry that causes the merchandise subtotal to be smaller than zero | Enable* |
| | | Disable |
| F | Subtotal entry before tendering | Noncompulsory* |
| | | Compulsory |
| G | Subtotal entry before direct non-tender finalization | Noncompulsory* |
| | | Compulsory |
| H | Direct non-tender finalization after tendering | Disable |
| | | Enable* |

Job code: 64

| * Item: | Selection: | Entry: |
|---------|---|---------|
| A | Printing of GT1 on Z report | Yes* |
| | | No |
| B | Printing of GT2 on Z report | Yes* |
| | | No |
| C | Printing of GT3 on Z report | Yes* |
| | | No |
| D | Printing of Training GT on Z report | Yes* |
| | | No |
| E | Printing of Z counter on Z report | Yes* |
| | | No |
| F | Printing of DATA on PLU resetting report | Yes* |
| | | No |
| G | Resetting of GT1, 2, 3 at the general Z1 report | No* |
| | | Yes |
| H | OP X/Z report | Enable* |
| | | Disable |

Job code: 65

| * Item: | Selection: | Entry: |
|---|------------|--------|
| A Printing of balance GT on Z report | Yes | 0 |
| | No* | 1 |
| B Resetting of balance GT at the general Z1 report | No* | 0 |
| | Yes | 1 |
| C to H Always enter 0. | | 0 |

Job code: 66

| * Item: | Selection: | Entry: |
|---|---|--------|
| A After transaction receipt | Total only | 0 |
| | Details* | 1 |
| B Amount printing when PLU unit price is zero | No* | 0 |
| | Yes | 1 |
| C Conversion SBTL printing of native SBTL | Yes* | 0 |
| | No | 1 |
| D VAT/tax assignment print | Yes | 0 |
| | No* | 1 |
| E Compression print on journal at PGM, X1/Z1 and X2/Z2 modes | No (normal size) | 0 |
| | Yes (small size)* | 1 |
| F Compression print on journal at REG, MGR and VOID modes | No (normal size) | 0 |
| | Yes (small size)* | 1 |
| G Logo text print on journal | No* | 0 |
| | Yes | 1 |
| H Footer print control | All receipts* | 0 |
| | Only on selected function key at the time of finalization | 1 |

Compression print on journal

- This selection is valid when "printing style" (job code 6) is set to "journal printing".

Job code: 67

| * Item: | Selection: | Entry: |
|---|--------------------------------------|--------------------|
| A Rounding amount printing | No* | 0 |
| | Yes (for Australian system) | 1 |
| B Total amount rounding when a transaction is finalized directly by CH1 , CH2 , CR1 or CR2 key | Rounding* | 0 |
| | Not rounding (for Australian system) | 1 |
| C Rounding up of the unit digit of amount | | 0 - 9 (default: 0) |
| D Rounding down of the unit digit of amount | | 0 - 9 (default: 0) |
| E Application of rounding | Item and payment* | 0 |
| | Payment | 1 |
| F Limit of the least significant digit in entering amount of item | Arbitrary* | 0 |
| | 0 only | 1 |
| | 0 and 5 only | 2 |
| G Memory of difference due to rounding | No* | 0 |
| | Yes | 1 |
| H Limit of the least significant digit in entering amount of payment | Arbitrary* | 0 |
| | 0 only | 1 |
| | 0 and 5 only | 2 |

Rounding amount printing (A)

Total amount rounding when a transaction is finalized directly by CH1, CH2, CR1 or CR2 key(B)

- When you live in Australia, set as shown on the table below for the parameters A and B.

Rounding up of the unit digit of amount (C)

Rounding down of the unit digit of amount (D)

- Handle C and D as a pair. When you live in Australia, Switzerland, Norway or South Africa, set as shown on the table below for the parameters C and D.

The rounding is performed as follows:

In case C = 0: Unit digit of amount < or = Value of D — rounding down

Value of D < or = Unit digit of amount — rounding to 5

In other cases: Unit digit of amount < or = Value of D — rounding down

Value of D < Unit digit of amount < Value of C — rounding to 5

Value of C < or = Unit digit of amount — rounding up

Application of rounding (E)

Limit of the least significant digit in entering amount of item (F)

Memory of difference due to rounding (G)

Limit of the least significant digit in entering amount of payment (H)

- When you live in Australia, Switzerland, Norway or South Africa, set as shown on the table below for the parameters E through H.

| | CD | E | F | G | H |
|--------------|----|----------------|--------------|-----|--------------|
| Switzerland | 82 | Item & payment | 0 and 5 only | No | 0 and 5 only |
| Norway | 54 | Payment | Arbitrary | Yes | 0 only |
| South Africa | 05 | Payment | Arbitrary | Yes | 0 and 5 only |

| | A | B | CD | E | F | G | H |
|-----------|-----|--------------|----|----------|-----------|-----|--------------|
| Australia | Yes | Not rounding | 82 | Payment* | Arbitrary | Yes | 0 and 5 only |

* Applied to payment by cash and change amount.

Job code: 68

| * Item: | Selection: | Entry: |
|--|---|--------|
| A GLU code automatic generation | Enable* | 0 |
| | Disable | 1 |
| B Always enter 0. | | 0 |
| C Temporary EJ printing during a transaction | Disable | 0 |
| | Enable* | 1 |
| D EJ printing and clearing EJ data when issuing general Z1 report | No* | 0 |
| | Yes | 1 |
| E PGM mode operation records type | Details* | 0 |
| | Header information only | 1 |
| F REG/MGR/VOID modes operation records type | Details* | 0 |
| | Total | 1 |
| G Compressing printing for EJ data | No (normal size) | 0 |
| | Yes (small size)* | 1 |
| H Action when EJ memory area is full | Continue | 0 |
| | Continue and warning (near full warning)* | 1 |
| | Lock and warning (with near full warning) | 2 |

Temporary EJ printing during a transaction

- If selecting "enable", you can print journal data of a current transaction recorded in EJ memory by pressing the **RCPT** key during the transaction. To realize this function completely, the cash register must be programmed to print the receipt and set the Receipt ON/OFF function to OFF.

PGM mode operation records type

- The header information only is printed during the program reading operation. The header information only is printed for X/Z reports.

(Receipt sample for Header Information only)

```

26/08/2003 14:08      01
123456#0419 DAVID
*X1*
*  DEPT  *
*TRANS- *
    
```

Action when EJ memory area is full

- By default, when the memory for EJ becomes nearly full, the cash register shows "N" at the 14th position of the display (EJ memory nearly full message), and the cash register keeps storing new data while erasing the oldest data. When "0" is selected, the cash register will no longer show EJ memory nearly full message. When "2" is selected, the cash register shows EJ memory nearly full message and when the memory is totally full, the cash register locks the sales/data entry with a display of the memory full message "EJ DATA FULL". You must issue an EJ report (Z1 report) at this time.

Job code: 69

| * Item: | Selection: | Entry: |
|---|---------------------------|--------|
| A G.C. receipt (bill) print on journal | No* | 0 |
| | Yes | 1 |
| B Always enter 0. | | 0 |
| C Always enter 1. | | 1 |
| D Rounding of foreign currency for EX | Rising to unit* | 0 |
| | Round off (4 down/5 up) | 1 |
| E Tax system | Auto tax 1-4 | 0 |
| | Auto VAT 1-4* | 1 |
| | Manual VAT 1-4 | 2 |
| | Manual VAT 1 | 3 |
| | Manual tax 1-4 | 4 |
| | Auto VAT 1 & Auto tax 2-4 | 5 |
| F Tax print when taxable subtotal is zero | No* | 0 |
| | Yes | 1 |
| G Tax print when tax is zero | Yes* | 0 |
| | No | 1 |
| H Rounding system | Normal* | 0 |
| | Sweden | 1 |
| | Denmark | 2 |

Rounding system

- When you live in Sweden or Denmark, change the default setting (H=0) to the corresponding setting.

3 Various Function Selection Programming 2

The cash register provides various options so you can use the register to suit your sales needs. In this section, you can program the following features (parameters within parentheses indicates default setting):

- Power save mode (entering the power save mode after 30 minutes)
- Logo message print format (Header 6-line message)
- Thermal printer density (standard density)
- Language selection (English)
- EJ memory type (EJ 9000 records and PLU 210 codes)
- Training clerk specification (none) - If you specify a clerk number who is trained for use on this cash register, the cash register will go into training mode when the clerk is signed on for sales entries. The sales operations done by the trained clerk do not affect sales totals. For details, refer to TRAINING MODE section.

Power save mode

Procedure

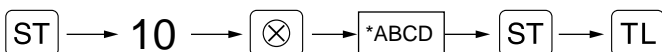

| * Item: | Selection: | Entry: |
|--|------------|---------------------------------|
| A Entering power save mode when time is displayed | Yes* | 0 |
| | No | 1 |
| B-D Time(min.) to entering power save mode since no operation is made | | 001-254 or 999 (Default 030) |

Note

When 999 is set for B to D, entering into power save mode is inhibited.

Key operation example

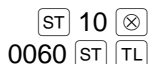

Print

```
*PGM*
#10      0060
```

Logo message print format

You can select the number of lines for your logo message, and the position to print it on receipt. For details of the logo message type, please refer to "Logo messages" on page 46.

Procedure

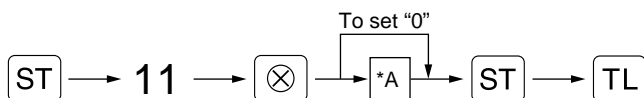

- *A: Logo message type
- 0: Header 3-line message without graphic logo
 - 3: Header 6-line message (default)
 - 5: Header 3-line message and footer 3-line message

Key operation example



Print

```
*PGM*
#11      0
```

■ Thermal printer density

Procedure

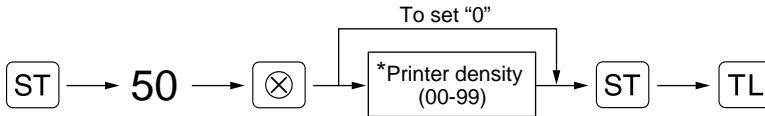

* 50 (100%) is the default setting. To make the print darker, set a larger number, and to make the print lighter, set a smaller number.

Key operation example

ST 50 ⊗
70 ST TL

Print

```
*PGM*
#50          70
```

■ Language selection

Procedure

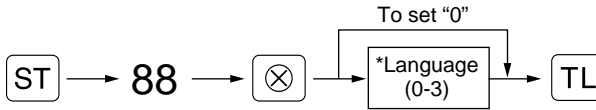

*Language: 0: English 1: German 2: French 3: Spanish
By default, English is set.

Key operation example

ST 88 ⊗
1 TL

Print

```
*PGM*
#88          1
```

Caution

When you change the language, the texts such as clerk names, logo messages and function texts (refer to page 45), which you programmed, will be reset to the default settings. The language selection must be made before programming clerk names, logo messages and function texts.

■ EJ memory type

Caution

When this procedure is executed, EJ data is cleared, and PLU data (programming data and sales data) are reset to the default after all data is cleared even if the same memory type is selected.

Procedure

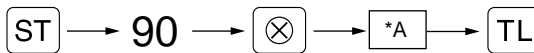

*A: 0 for EJ 8000 lines and PLU 1200 codes
1 for EJ 9000 lines and PLU 210 codes (default)

Key operation example

ST 90 ⊗
0 TL

Print

```
*PGM*
#90          0
```

■ Training clerk specification for training mode

For the details of clerk training, please refer to "TRAINING MODE" on page 63.

Procedure

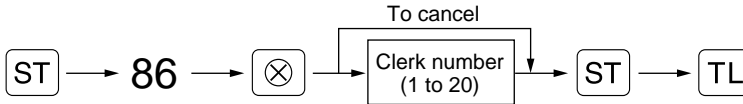

Key operation example

ST 86 X
20 ST TL

Print

```
*PGM*
#86      20
```

■ AUTO key programming — Automatic sequence key

If you program frequently performed transactions or report sequences for the **AUTO** key, you can recall those transactions and/or reports simply by pressing the **AUTO** key in key operations.

Procedure

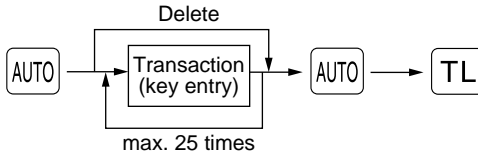

Programming for **AUTO**; entering a PLU 2 item and a dept. 6 item (unit price: 1.00)

Key operation example

AUTO setting → 2 100 AUTO 6
AUTO TL

Print

```
*PGM*
#01
P0002
1
0
0
D06
```

Note

When the **AUTO** key has been programmed to execute a report job function, the mode switch must be in the appropriate position (OPX/Z for individual clerk reports, X1/Z1 for daily reports or X2/Z2 for weekly or monthly reports).

4 EURO Programming

For details of EURO migration operation, please refer to “EURO MIGRATION FUNCTION”.

■ EURO system settings

Procedure

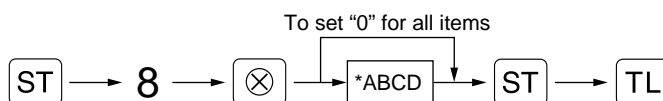

| * Item: | Selection: | Entry: |
|---------|--|-----------------------------|
| A | Printing exchange total amount and change amount on receipt or journal | No* Yes |
| B | Always enter 0. | 0 |
| C | Cheque and credit operation when tendering in foreign currency | No* Yes |
| D | Exchange calculation method | Multiplication* Division |
| | | 0 1 |

Printing exchange total amount and change amount on receipt/journal

- Total and change amounts in exchange currency are printed respectively below each of the total and exchange amounts in domestic currency.

Exchange calculation method

- “Division” or “Multiplication” can be selected for the conversion method from domestic currency to exchange currency, and the calculation is performed as follows:

In case that “Division” is selected:

Domestic currency amount ÷ Exchange rate = Exchange amount

In case that “Multiplication” is selected

Domestic currency amount × Exchange rate = Exchange amount

Key operation example

```

  ST 8 ⊗
  1000 ST
      TL
  
```

Print

```

  *PGM*
  #8      1000
  
```

■ Automatic EURO modification operation settings

Procedure

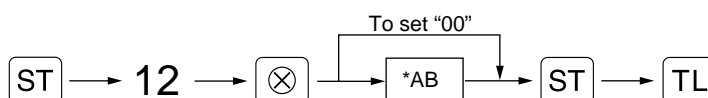

| * Item: | Selection: | Entry: |
|---------|---|-------------------------------|
| A | Converting the preset unit price of Dept./PLU in the automatic modification operation for EURO (job #800 in the X2/Z2 mode) | Yes* No |
| B | Automatic modification operation for EURO (job #800 in the X2/Z2 mode) at the preset date | Compulsory* Non-compulsory |
| | | 0 1 |

Key operation example

```

  ST 12 ⊗
  01  ST
      TL
  
```

Print

```

  *PGM*
  #12     01
  
```

Note

If you have already made the Job #800 operation with the substitution of 3 for “A” in the X2/Z2 mode, this programming is disabled.

■ Date setting for EURO modification operation

Procedure

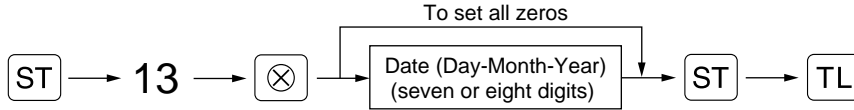

Key operation example

```

    ST 13 [X]
    01072005 ST
           TL
  
```

Print

```

    *PGM*
    #13      01/07/2005
  
```

Note

- In case you changed the date format using job code 61, follow the format you selected for setting the date.
- If all zeros are set, this programming is disabled.
- If you have already made the Job #800 operation with the substitution of 3 for "A" in the X2/Z2 mode, this programming is disabled.

■ Time setting for EURO modification operation

Procedure

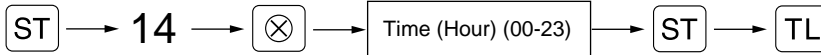

Key operation example

```

    ST 14 [X]
    10 ST
       TL
  
```

Print

```

    *PGM*
    #14      10:00
  
```

Note

- If you have already made the Job #800 operation with the substitution of 3 for "A" in the X2/Z2 mode, this programming is disabled.

5 Reading Stored Programs

The machine allows you to read every program stored in the PGM mode.

Key sequence for reading stored program

| Report name | Key sequence |
|------------------------------------|---|
| Programming report 1 | TL |
| Programming report 2 | 2 → TL |
| Auto key programming report | 1 → TL |
| Printer density programming report | 3 → TL |
| Department programming report | 4 → TL |
| PLU programming report | Start PLU code → ⊗ → End PLU code → PLU/SUB |

Note To stop reading programming report, turn the mode switch to the MGR position.

Sample printouts

1 Programming report 1

```

*PGM*
F01 (→) 006
          -2.00
F02 %    000
L 15.00% -10.25%
F03 DIFFER
F04 TAX1 ST
F05 TAX2 ST
F06 TAX3 ST
F07 TAX4 ST
F08 VAT 1
F09 VAT 2
F10 VAT 3
F11 VAT 4
F12 NET1
F13 NET2
F14 REFUND
F15 S
F16 ⊗ MODE
F17 MGR ⊗
F18 SBTL ⊗
F19 BILL CNT
F20 NO SALE
F21 ***PBAL
F22 ***NBAL
F23 GUEST
F24 ORDER TL
F25 PAID TL
F26 AVE.
F27 O-P
F28 ***RA 9
F29 ***PD 9
F30 CASH 008
F31 CHECK1 018
F32 CHECK2 008
F33 CARD1 008
F34 CREDIT2 008
F35 EXCH1 102
US $ 0.939938
F36 EXCH2
    
```

```

Mode
Function no.& its text
Function parametrs (B-D)
Discount amt. w/sign
Function parametrs (B-D)
Percent rate with sign
Percent limit
Entry digit limit
Function parameters (A-C)
Foreign currency symbol/Rate
    
```

```

F74 COPY
F75 BILL
F76 EJ
F77 EJ END
SHARP
PRESENTS THE
XE-A212
SHARP
IS
THE BEST
#5 00000100
#6 11000111
#7 00000000
#8 0010
#10 0060
#11 3
#12 01
#13 01/07/2005
#14 10:00
#15 00000000
#30 000001
#31 0
#32 06
#33 002 013
#35 007
T1 -----
T2 4.0000%
    0.12
T3 -----
T4 -----
C#01 DAVID
C#02 CLERK 02

C#19 CLERK 19
C#20 CLERK 20
    
```

Logo Message

Function selection for miscellaneous keys (A-H)

Print format (A-H)

Receipt print format(A-H)

EURO system settings (A-D)

Power save mode(A-D)

Logo message print format

Automatic EURO modification operation settings (AB)

Date setting for EURO modification operation

Time setting for EURO modification operation

PLU level shift and GLU function parameters

*Job code #30 to #35 are fixed settings, for which you cannot change the settings.

Tax rate

Min. taxable amount

Clerk code/name

2 Programming report 2

| | | |
|-------|----------------|---|
| *PGM* | | |
| #61 | 00100112 | Job code |
| #62 | 01000000 | |
| #63 | 01000001 | A to H from the left |
| #64 | 00000000 | * Job code #70, 71, 72, 76 and 77 are fixed settings, for which you cannot change the settings. |
| #65 | 00000000 | |
| #66 | 10011100 | |
| #67 | 00000010 | |
| #68 | 00100011 | |
| #69 | 00101000 | |
| #70 | 00000000 | |
| #71 | | |
| GT2 | *0000000000.00 | |
| #72 | | |
| GT3 | *0000000000.00 | |
| #76 | 21 0000 | |
| #77 | 22 0000 | |
| #85 | * | Domestic currency symbol |
| #86 | 20 | Training clerk specification |
| #87 | **TRAINING** | Training mode text |
| #88 | 0 | Language selection |
| #90 | 1 | EJ memory type |

5 Department programming report

| | | | | |
|------------|---------|----|--------|-------------------------|
| *PGM* | | | | |
| Dept. code | D01 | T1 | 083 | Dept. function |
| Dept. text | FRUIT | | 10.00 | Dept. unit price w/sign |
| | D02 | T1 | 183 | |
| | DEPT.02 | | -13.10 | Minus department |
| | D03 | T1 | 083 | |
| | DEPT.03 | | 1.50 | Tax status |
| | | | | |
| | D49 | T1 | 081 | |
| | DEPT.49 | | 0.00 | |
| | D50 | T1 | 081 | |
| | DEPT.50 | | 0.00 | |

6 PLU programming report

| | | | | |
|----------|-----------|--|-----------|-----------------------|
| *PGM* | | | | |
| | | | 0001-0015 | Range |
| PLU code | P0001(03) | | 0 | Mode parameter |
| PLU text | MELON | | 1.25 | Unit price |
| | P0002(01) | | 1 | |
| | PLU.0002 | | 2.15 | |
| | P0003(32) | | 1 | |
| | PLU.0003 | | -0.15 | Associated dept. code |
| | | | | |
| | PLU.0014 | | 1.00 | |
| | P0015(01) | | 1 | |
| | PLU.0015 | | 1.50 | |

3 Auto key programming report

| | |
|-------|-------|
| *PGM* | |
| #01 | |
| | P0002 |
| | 1 |
| | 0 |
| | 0 |
| | D06 |

4 Printer density programming report

| | | |
|-------|----------------|----------------------------------|
| *PGM* | | |
| #50 | 50 | Entered value Printer density |
| 10 | : 0123456789AB | Printing density example |
| 20 | : 0123456789AB | |
| 30 | : 0123456789AB | |
| 40 | : 0123456789AB | |
| 50 | : 0123456789AB | |
| 60 | : 0123456789AB | |
| 70 | : 0123456789AB | |
| 80 | : 0123456789AB | |
| 90 | : 0123456789AB | |

TRAINING MODE

The training mode is used when the operator or the manager practices register operations.

When a clerk in training is selected, the machine automatically enters the training mode. To specify a clerk to be trained, refer to "Training clerk specification for training mode" in "ADVANCED FUNCTION PROGRAMMING" in page 58.

The training operation is valid only in REG, MGR and  mode.

The corresponding clerk memory is only updated in the training mode.

Key operation example

A clerk set in training → 20
1000
3

Print

| | |
|---------------------|---------------|
| 06/08/2003 15:50 | 20 |
| 123456#1051 CLERK | 20 |
| **TRAINING** | |
| DEPT.05 | *10.00 |
| 3x 24.00 | |
| DEPT.03 | *72.00 |
| ITEMS | 40 |
| CASH | *82.00 |

READING (X) AND RESETTING (Z) OF SALES TOTALS

- Use the reading function (X) when you need to take a reading of sales information entered since the last reset. You can take this reading any number of times. It does not affect the register's memory.
- Use the resetting function (Z) when you need to clear the register's memory. Resetting prints all sales information and clears the entire memory except for the GT1 through GT3, Training GT, BAL, reset count, and consecutive number.

1 Summary of Reading (X) and Resetting (Z) Reports

X1 and Z1 reports: Daily sales reports

X2 and Z2 reports: Periodic (monthly) consolidation reports

When you take an X or Z report, turn the mode switch to the appropriate position referring to the column of "Mode switch position" shown on the table below, and use the following corresponding key sequence.

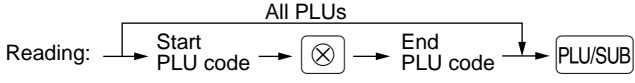
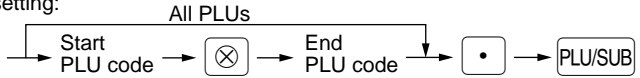
| Item | Mode switch position | | | Key operation |
|---|----------------------|--------|--------|--|
| | OPX/Z | X1/Z1 | X2/Z2 | |
| Flash report: (Only display) To clear the display, press the CL key or turn the mode switch to another position. | X | - | - | Dept. code → DEPT# : Department sales total [For dept. 1 to 6: Dept. key (1 to 6)] |
| | | | | ⊗ key: Amount of cash in drawer |
| | | | | TL key: Sales total |
| Full sales report | - | X1, Z1 | X2, Z2 | Reading: TL Resetting: • → TL |
| PLU report by designated range | - | X1, Z1 | - | Reading:  Resetting:  |
| Individual clerk report | X, Z | - | - | Reading: CLK# Resetting: • → CLK# (The report of the current clerk) |
| Full clerk report | - | X1, Z1 | - | Reading: CLK# Resetting: • → CLK# |
| Hourly report | - | X1, Z1 | - | Reading: ST Resetting: • → ST |
| Open GLU report | - | X1, Z1 | - | Reading: GLU Resetting: • → GLU |
| Open GLU report by clerk | - | X1, Z1 | - | Reading: CR1 Resetting: • → CR1 (The report of the current clerk) |
| Balance report | - | X1 | - | Reading: RA |

Note

- When both sales quantities and sales amounts are zero, printing is skipped. If you do not want to skip, change the programming. (Refer to "Print format" of "Various Function Selection Programming 1".)
- "X" represents read symbol and "Z" represents reset symbol in the reports.
- To stop reading and resetting the PLU sales report, turn the mode switch to the MGR position. The data will not be erased when you reset.
- The drawer does not open when you take X/Z reports. The drawer can be opened by pressing the **NS** key to remove the till after closing your business.
- When printing is performed continuously, the printing may be intermitted several seconds. After the intermission, the printing will be restarted.

2 Daily Sales Totals

Full sales report

• Sample report

| | | |
|-----------------|-----------------|--|
| *Z1* | | Mode title*1 |
| | Z1 0003 | Reset counter |
| GT1 | *00000003324.48 | Net grand total (GT2-GT3) |
| GT2 | *00000003640.88 | Grand total of plus registration |
| GT3 | -00000000316.40 | Grand total of minus registration |
| BAL | *00000000182.00 | Grand total of balance *3 (order total-paid total) |
| TR | *00000000272.55 | Grand total of training mode registration |
| ----- | | |
| * DEPT * | | Dept. code |
| DO1 | 60 Q | Sales q'ty |
| DEPT.01 | *701.70 | Sales amount |
| DO2 | 3 Q | |
| DEPT.02 | *31.00 | |
| DO3 | 4 Q | |
| DEPT.03 | *44.00 | |
| DO5 | 2 Q | |
| DEPT.05 | *4.50 | |

| | | | |
|------------------|----------|----------|------------------------------------|
| D50 | 6 Q | | |
| DEPT.50 | *31.40 | | |
| *DEPT TL | 91 Q | | "+" dept. counter and total |
| | *1038.90 | | |
| ----- | | | |
| D35 | 3 Q | | |
| DEPT.35 | -17.00 | | |
| DEPT (-) | 3 Q | | "-" dept. counter and total |
| | -17.00 | | |
| ----- | | | |
| *TRANS. * | | | |
| (-) | 1 Q | | Subtotal ⊖ counter and total |
| | -1.00 | | |
| % | 2 Q | | Subtotal percent counter and total |
| | -7.88 | | |
| NET 1 | | *1013.02 | Net sales total *4 |
| ----- | | | |
| TAX1 ST | | *745.47 | Taxable 1 total |
| VAT 1 | | *124.25 | VAT 1 total |
| TAX2 ST | | *244.12 | |
| VAT 2 | | *31.84 | |
| TAX3 ST | | *225.57 | |
| VAT 3 | | *20.51 | |
| TAX4 ST | | *230.07 | |
| VAT 4 | | *34.27 | |
| TTL TAX | | *210.87 | Tax total |
| NET | | *802.15 | Net total without tax *5 |

| | | | |
|------------------|------|-------------|---|
| (-) | 2 Q | -1.50 | Item ⊖ counter and total |
| % | 2 Q | -2.05 | Item percent counter and total |
| REFUND | 1 Q | | |
| | | *12.00 | Refund counter and total |
| ∞ | 6 Q | | |
| | | *64.30 | REG-mode void counter and total |
| ∞ MODE | 1 Q | | |
| | | *20.00 | Void-mode transaction counter and total |
| MGR ∞ | 2 Q | | |
| | | *20.00 | Manager item void counter and total |
| SBTL ∞ | 1 Q | | |
| | | *60.90 | Subtotal void counter and total |
| ----- | | | |
| BILL CNT | 5 Q | | Bill(G.C.RCPT) counter |
| NO SALE | 2 Q | | No-sales counter |
| ***PBAL | 6 Q | | PBAL counter |
| ***NBAL | 4 Q | | NBAL counter |
| GUEST | 49 Q | | Customer counter |
| ----- | | | |
| ORDER TL | | *1013.02 | Order total |
| PAID TL | | *950.02 | Paid total |
| AVE. | | *19.39 | Paid total average per customer |
| O-P | | *63.00 | Order total-Paid total |
| ***RA | 2 Q | | Received on account counter and total |
| | | *23.00 | |
| ***PO | 1 Q | | Paid out counter and total |
| | | *48.00 | |
| ----- | | | |
| CASH | 36 Q | | Cash counter and total |
| | | *466.82 | |
| CHECK1 | 3 Q | | Cheque1 sales counter and total |
| | | *92.30 | |
| CHECK2 | 3 Q | | |
| | | *100.00 | |
| CREDIT1 | 2 Q | | Credit1 sale and tendering counter and total |
| | | *48.00 | |
| CREDIT2 | 1 Q | | |
| | | *20.00 | |
| EXCH1 | 1 Q | | Exchange counter and total (in preset rate entry) |
| | | US \$100.00 | |
| DOM. CUR1 | | *106.38 | Domestic currency |
| EXCH2 | 1 Q | | Exchange manual rate entry counter and total |
| | | 100.00 | |
| DOM. CUR2 | | *78.42 | |

(To be continued on the next page)

| | | | |
|-----------|-----|---------|--|
| EX1 CHK | 1 Q | | } Exchange check (in preset rate entry) |
| | US | \$32.90 | |
| DOM. CUR1 | | *35.00 | |
| EX1 CR | 1 Q | | } Exchange credit (in preset rate entry) |
| | US | \$57.34 | |
| DOM. CUR1 | | *61.00 | |
| ----- | | | |
| ****CID | | *383.92 | Cash in drawer |
| *CH ID | | *192.30 | Cheque in drawer |
| CA/CH ID | | *576.22 | Cash + cheque in drawer |
| CHK/CG | | *12.10 | Change total for cheque tendering |

- *1: When you take X1 report, "X1" is printed.
- *2: Printed in the Z1 report only.
- *3: BAL is not printed by default. To print, change the setting on job code 65.
- *4: When "Memory of difference due to rounding" is set to "yes" the following is displayed here.

| | |
|--------|-------|
| DIFFER | -0.05 |
|--------|-------|

- *5: When manual tax 1-4 system or auto tax 1-4 system is selected, the following is displayed here.

| | | |
|------|----------|---------------------------|
| NET2 | *1013.02 | Sales total including tax |
|------|----------|---------------------------|

■ PLU report by designated range

• Sample report

| | | | |
|------------|----------|-----------|------------------------|
| | *X1* | | Mode title* |
| | * PLU * | | Report title |
| | | 0001-0015 | Range |
| PLU code | P0001 | 19 Q | } Sales q'ty and total |
| Item label | PLU.0001 | *29.83 | |
| | P0002 | 21 Q | |
| | PLU.0002 | *31.50 | |
| | P0010 | 4 Q | |
| | PLU.0010 | *28.60 | |
| | P0011 | 11 Q | |
| | PLU.0011 | *99.30 | |
| | P0012 | 8 Q | |
| | PLU.0012 | *18.88 | |
| | P0013 | -7 Q | |
| | PLU.0013 | -14.70 | |
| | P0015 | 1 Q | |
| | PLU.0015 | *5.75 | |
| ----- | | | |
| | ***TOTAL | 57 Q | } Range sum |
| | | *199.16 | |

*: When you take Z1 report, "Z1" is printed.

■ Individual clerk report

• Sample report

| | | |
|-----------|-------------|------------------------|
| *OPX* | | Mode title* |
| * CLERK * | | Report title |
| O1# | CLERK 01 | Clerk code |
| ORDER TL | *805.44 | Clerk name |
| PAID TL | *716.44 | Order total |
| AVE. | *27.56 | Paid total |
| O-P | *89.00 | Average |
| ***PBAL | 10 Q | Order total-Paid total |
| ***NBAL | 6 Q | PBAL counter |
| GUEST | 26 Q | NBAL counter |
| | | Customer counter |
| ----- | | |
| ∞ | 5 Q | |
| | *52.70 | |
| ∞ MODE | 1 Q | |
| | *14.00 | |
| MGR ∞ | 2 Q | |
| | *14.00 | |
| SBTL ∞ | 1 Q | |
| | *60.90 | |
| ----- | | |
| EXCH1 | 1 Q | |
| | US \$100.00 | |
| DOM. CUR1 | *106.38 | |
| EXCH2 | 1 Q | |
| | 100.00 | |
| DOM. CUR2 | *78.42 | |
| ****CID | *135.19 | |
| *CH ID | *135.00 | |
| CA/CH ID | *270.19 | |
| ----- | | |

■ Full clerk report

The printout occurs in the same format as in the sample report of individual clerk, but all clerk's sales data and total of all clerks are printed in the order of clerk number (from #1 to #20).

Hourly report

Sample report

| | | | |
|-----------------|------|---------|------------------|
| *X1* | | | Mode title* |
| *HOURLY* | | | Report title |
| 10:00 | 12 Q | | Customer counter |
| | | *119.98 | Sales total |
| 11:00 | 18 Q | | |
| | | *186.89 | |
| 12:00 | 25 Q | | |
| | | *199.91 | |
| 13:00 | 7 Q | | |
| | | | |
| 17:00 | 18 Q | | |
| | | *126.69 | |
| 18:00 | 16 Q | | |
| | | *92.26 | |

*: When you take Z1 report, "Z1" is printed.

Open GLU report

Sample report

| | | |
|----------------|--------|------------------|
| *X1* | | Mode title* |
| * GLU * | | Report title |
| 02# | 01 | Clerk code |
| ***PBAL | *7.00 | Previous balance |
| 04# | 01 | GLU code |
| ***PBAL | *9.00 | |
| 05# | 01 | |
| ***PBAL | *33.00 | |
| 10# | 02 | |
| ***PBAL | *15.00 | |
| 12# | 02 | |
| ***PBAL | *15.00 | |
| ----- | | |
| ***TOTAL | | |
| ***PBAL | *79.00 | |

*: When you take Z1 report, "Z1" is printed.

Open GLU report by clerk

Sample report

| | | |
|----------------|----------|-----------------|
| *X1* | | Mode title |
| * GLU * | | Report title |
| 01# | CLERK 01 | Clerk code/name |
| 02# | | |
| ***PBAL | *7.00 | |
| 04# | | |
| ***PBAL | *9.00 | |
| 05# | | |
| ***PBAL | *33.00 | |
| ----- | | |
| ***TOTAL | | |
| ***PBAL | *49.00 | |

*: When you take Z1 report, "Z1" is printed.

Balance report

Sample report

| | | |
|--------------------|---------|-------------------------------|
| *X1* | | Mode title |
| * BALANCE * | | Report title |
| OLD BAL. | *0.00 | Total balance on previous day |
| ORDER TL | *283.50 | Order total |
| PAID TL | *204.50 | Paid total |
| BALANCE | *79.00 | Balance |

3 Periodic Consolidation

Full sales report

Sample report

| | | |
|-------------|-----------------|---|
| *Z2* | | Mode title*1 |
| | Z1 0003 | Reset counter of daily total |
| | Z2 0001 | Reset counter of periodic consolidation |
| GT1 | *00000003324.48 | Grand total |
| GT2 | *00000003640.88 | |
| GT3 | -00000000316.40 | |
| BAL | *00000000182.00 | |
| TR | *00000000272.55 | |

The subsequent printouts are the same in format as in the X1/Z1 full sales report.

*1: When you take X2 report, "X2" is printed.

*2: Printed in the Z2 report only



EJ REPORT READING AND RESETTING

The cash register provides an electronic journal (EJ) function. This function is intended to record the journal data in a memory instead of journal paper, and print the data as an EJ report. The register records the journal data in REG, PGM, , X1/Z1 and X2/Z2 modes. By default, a maximum of 9000 lines are stored in the memory. For details of EJ programming, please refer to "Other programming (Job code 68)" on page 54 and "EJ memory type" on page 57.

■ Printing journal data on the way of a transaction

You can print journal data of a current transaction recorded in EJ memory by pressing the  key during the transaction.

Note This function is valid when the printing style is programmed to receipt, and the receipt ON/OFF function is set to OFF.



• Sample print

| | |
|---------------------|---------------------|
| * EJ * | EJ report title |
| 26/08/2003 13:59 01 | |
| 123456#0398 DAVID | |
| DEPT. 07 *10.00 | |
| DEPT. 08 *25.00 | |
| * EJ END * | EJ report end title |

■ Reading and resetting the electronic journal data (Issuing EJ report)

You can read the journal data stored in the EJ memory in the journal format by executing the following procedure in the X1/Z1 or OP X/Z mode.



To read all of the data:

700 →  → 

To reset all of the data:

700 →  →  → 

To read the last 10 records:

710 →  → 

Note

- To stop reading or resetting the data, turn the mode switch to "MGR" position. The data will not be erased when resetting.
- On the EJ memory, a maximum of 9000 (or 8000, depending on programming) lines of data can be stored. When executing all data reading, all of the data stored in the EJ memory will be printed.
- When printing is performed continuously, the printing may be intermitted several seconds. After the intermission, the printing will be restarted.

• Sample EJ report

```
*OPX*
* EJ *
26/08/2003 14:07 01
123456#0412 DAVID
DEPT. 12 *12.50
ITEMS 10
CASH *12.50
26/08/2003 14:07 01
123456#0413 DAVID
DEPT. 07 *2.45
DEPT. 08 *7.85
```

```
26/08/2003 14:08 01
123456#0418 DAVID
***RA *25.00
26/08/2003 14:08 01
123456#0419 DAVID
*X1*
* DEPT *
*TRANS *
26/08/2003 14:08 01
123456#0420 DAVID
DEPT. 10 *12.56
DEPT. 15 *12.69
ITEMS 20
CASH *25.25
26/08/2003 14:08 01
123456#0421 DAVID
DEPT. 04 *1.25
3x 1.50
DEPT. 13 *4.50
ITEMS 40
CASH *5.75
* EJ END *
```

Header information print

OVERRIDE ENTRIES

Programmed limit for functions (such as for maximum amounts) can be overridden by making an entry in the MGR mode.

Procedure

1. Turn the mode switch to the MGR position.
2. Make an override entry.

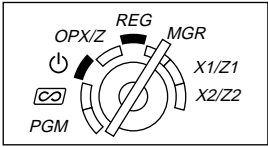

Example

In this example, the register has been programmed not to allow discounts entries over 1.00.

Key operation example

REG mode 1500
 entries 250 ...Error

Turn the mode switch to the MGR position.

250

Return the mode switch to the REG position.

Print

```

DEPT. 03      *15.00
(--)          -2.50

ITEMS        1Q
CASH *12.50
  
```

CORRECTION AFTER FINALIZING A TRANSACTION (Void mode)

When you need to void incorrect entries that clerks cannot correct (incorrect entries found after finalizing a transaction or cannot be corrected by direct or indirect void), follow this procedure:

1. Turn the mode switch to the position using the manager key (MA), to enter into the void mode.
2. Repeat the entries that are recorded on an incorrect receipt. (All data on the incorrect receipt is removed from register memory; the voided amounts are added to the void mode transaction totalizer.)

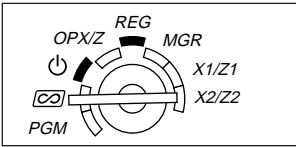

Incorrect receipt

```

DEPT. 04      *10.00
DEPT. 03      *1.50

ITEMS        2Q
CASH *11.50
  
```



Cancellation receipt

```

      *Q MODE *
DEPT. 04      *10.00
DEPT. 03      *1.50

ITEMS        2Q
CASH *11.50
  
```

EURO MIGRATION FUNCTION

Note

• *EURO programming described in this section are for users in the countries which will join to the members of the European Currency Union, not for the users in the countries already have joined the Union.*

Your register can be modified to correspond with each period set for the introduction of EURO, and in your register each currency is treated as shown on the table below depending on which period you are in. Basically your register can be automatically modified to correspond to the introduction of EURO by executing automatic EURO modification operation shown below in the X2/Z2 mode. However, there are several options you must set depending on your needs. So, please carefully conduct necessary settings.

How currencies are treated in your register

| | Period 1 | Period 2 | Period 3 |
|----------|--|---|---|
| | After the introduction of EURO, and before EURO banknotes and coins begin to circulate | After EURO banknotes and coins begin to circulate, and before national currency is withdrawn from circulation. (Co-existence of EURO and national currency) | After the national currency is withdrawn from circulation |
| Currency | EURO | Exchange key (Preset rate entry) | Domestic currency |
| | National currency | Domestic currency | Exchange key (Preset rate entry) |
| | Foreign currency | Exchange key (Manual rate entry) | Exchange key (Manual rate entry) |

Automatic EURO modification operation

Make sure the mode switch is in the X2/Z2 mode first, then perform the following procedure. Please note that you can perform each operation only once with the substitution of "A=1", "A=2" and "A=3". For example if you performed the operation with the substitution of "A=2" first, you cannot perform the operation with the substitution of "A=1".

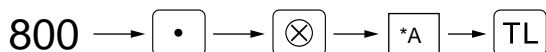

*A=1: Applicable for period 1

*A=2: Applicable for period 2

*A=3: Applicable for period 3

The details of the register system modification are as shown below:

| Items | A=1 (EURO status 1) | A=2 (EURO status 2) | A=3 (EURO status 3) |
|---|----------------------------|---|------------------------|
| General Z1 report | Issue | Issue | Issue |
| General Z2 report | Issue | Issue | Issue |
| GT memories (GT1, GT2, GT3 and Training GT) | - | Clear | Clear*1 |
| Conversion of preset prices of Dept./PLU | - | Yes | Yes*1 |
| Conversion of entry digit/amount limit | - | Yes | Yes*1 |
| Exchange amount printing for total and change | Yes | Yes | No |
| Exchange calculation method | Division | Multiplication | Multiplication |
| Domestic currency symbol | - | [EURO] | [EURO] |
| Domestic currency decimal point position | - | 2 | 2 |
| Exchange currency symbol | [EURO] | Previous domestic currency symbol | *2 |
| Exchange currency decimal point position | 2 | Previous domestic currency decimal point position | - |
| Rounding system (Denmark/Sweden/Normal) | - | Normal | Normal*1 |
| Rounding up/down of the unit digits of amount | - | No | No*1 |
| Lowest digit entering limitation of item | - | Arbitrary | Arbitrary*1 |
| Lowest digit entering limitation of payment | - | Arbitrary | Arbitrary*1 |
| Memory of difference due to rounding | - | No | No*1 |
| Rounding of exchange currency | Round off (4 down/5 up) | Round off | Round off |

- The item marked with “-” remains the same as the previous data.
- *1: When you perform from EURO status 2, previous data remains unchanged.
- *2: When you perform from EURO status 1 or 2, “space” is set.

IMPORTANT

- Conversion of the preset unit prices of departments and PLUs
Note that the conversion rate of the preset rate of the **[EX]** key is applied for the conversion, and the method is set to “division”. When the conversion is performed, the message “PRICE CONVERTED” will be printed on the #800 report.
- After the execution of the procedure with “A=1”, treat EURO as foreign currency using the exchange key **([EX])** with the preset rate entry. Set the EURO conversion rate as the currency exchange rate for the exchange key.
- After the execution of the procedure with “A=2”, treat EURO as domestic currency, and national currency as foreign currency using the exchange key **([EX])** with the preset rate entry. Set the EURO conversion rate as the currency exchange rate for the exchange key.
- As for the percent rate for **[%]** and **[⊖]**, the automatic conversion is not made. So, when your domestic currency becomes EURO, you must change these settings so that they are base on EURO currency.

Note

You can manually make these settings. For programming details, please refer to “EURO Programming” section.

Checking the current EURO status

You can check the EURO status currently set on the cash register. Set the manager key (MA) to the X2/Z2 position, and perform the following sequence. The current EURO status will be printed on the receipt/journal.



■ Optional Programming for the Introduction of EURO

Some programming relating with the function of exchange key (**EX**) cannot be changed automatically with the execution of modification operation described in the previous section. After the execution on each period, conduct the following programming depending on your needs.

Programming for Exchange Key (**EX**)

Currency exchange rate

For period 1 and period 2, set the EURO conversion rate.
For programming details, refer to “Rate for [%] and [EX]” on page 40.

Exchange rate entry selection

When you treat EURO currency in the exchange key, you must apply preset rate entry. So, make enable for preset rate entry for period 1 and period 2. For programming details, refer to “Function parameters for [EX]” on page 42.

Cheque/credit operation

For period 1 and period 2, enable cheque/credit operation when tendering in foreign currency so that you can treat cheque and credit for EURO currency and national currency. For programming details, refer to “EURO system settings” on page 59.

Setting the date and time when the automatic modification operation for EURO should be executed Selection of compulsory/non-compulsory of execution of the automatic modification operation for EURO

You can program the scheduled date and time to execute the automatic EURO modification operation .
From ten days before the preset date, the remaining days are printed at the bottom of the daily full resetting (Z1) report as follows.

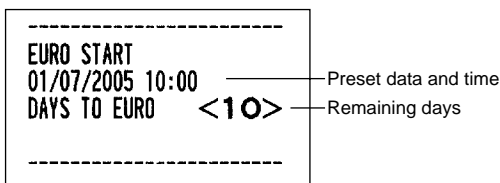

When the above-mentioned preset date and time has come, and also when you start an entry in the REG/MGR mode, the error message “EURO CHANGE” is displayed. You cannot make any operation in the REG/MGR mode until you execute the automatic modification operation for EURO (job #800) in the X2/Z2 mode.
You can program so that you can make entries in the REG/MGR mode even when the error message is displayed.

Date and time setting will be reset after the execution of the automatic modification operation and you can program again the date and time for the next automatic modification operation.

OPERATOR MAINTENANCE

1 In case of Power Failure

When power is lost, the machine retains its memory contents and all information on sales entries.

- When power failure is encountered in register idle state or during an entry, the machine returns to normal operation after power recovery.
- When power failure is encountered during a printing cycle, the register prints "===== " and then carries out the correct printing procedure after power recovery. (See the sample print.)

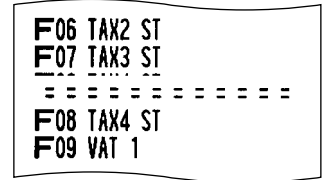

2 In Case of Printer Error

If the printer runs out of paper, the printer will stall, and "PAPER EMPTY" will appear on the display. Key entries will not be accepted. Refer to section 4 in this chapter, install a new roll, then press the **CL** key. The printer will print the power failure symbol and resume printing.

If the print roller arm comes up, the printer stalls, "HEAD UP" will appear on the display. Key entries will not be accepted. Push down the arm until it is securely locked, then press the **CL** key. The printer will print the power failure symbol and resume printing.

3 Cautions in Handling the Printer and Recording Paper

■ Cautions in handling the printer

- Avoid dusty and humid environments, direct sunlight and iron powder. (A permanent magnet and electromagnet are used in this machine.)
- Never pull the paper when the print roller arm is locked. First lift up the arm, and then remove the paper.
- Never touch the surface of the print head and print roller.

■ Cautions in handling the recording paper (thermal paper)

- Use only the paper specified by SHARP.
- Do not unpack the thermal paper until you are ready to use it.
- Avoid heat. The paper will color at around 70°C.
- Avoid dusty and humid storage places. Avoid direct sunlight.
- The printed text on the paper can discolor under conditions of high humidity and temperature, exposure to the direct sunlight, contact with glue, thinner or a freshly copied blueprint, and heat caused by friction from scratching or other such means.
- Be very careful when handling the thermal paper. If you want to keep a permanent record, copy the printed text with a photocopier.

4 Replacing the Batteries

This cash register displays a low battery warning message “LOW BATTERY” when the batteries are low, and displays a no battery warning message “NO BATTERY” when batteries are extremely low or batteries are not installed.

When the low battery message is displayed, replace the batteries with new ones as soon as possible. The existing batteries will be dead in about two days.

When the no battery message is displayed, replace the batteries immediately. Otherwise, if the AC power cord is disconnected or a power failure occurs, all the programmed settings will be reset to the default settings and any data stored in memory will be cleared.

Note Be sure to observe precautions shown on page 1 when handling batteries.

To replace the batteries:

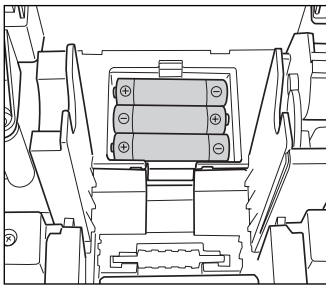

1. Make sure that the cash register is plugged in.
2. Turn the mode switch to the REG position.
3. Remove the printer cover.
4. Open the battery compartment cover next to the paper roll cradle and remove the old batteries.
5. Install three new R6 or LR6 batteries (“AA” size) in the battery compartment. Be sure the positive and negative poles of each battery are facing in the proper direction. When they are installed correctly, the “LOW BATTERY” or “NO BATTERY” will disappear.
6. Close the battery compartment cover.
7. Replace the printer cover.

5 Replacing the Paper Roll

Be sure to use paper rolls specified by SHARP.

The use of any other paper rolls other than those specified could cause paper jamming, resulting in register malfunction.

Paper specification

Paper width: 57.5 ± 0.5 mm

Max. outside diameter: 80 mm

Quality: Thermal paper

- Be sure to set the paper roll prior to using your machine, otherwise it may cause a malfunction.

Install the paper roll in the printer. Be careful to set the roll correctly.

(How to set the paper roll)



■ Removing the paper roll

When a red dye appears on the paper roll, it is time to replace it. Replace the paper roll with a new one. If you plan on not using the register for an extended period of time, remove the paper roll, and store it in an appropriate place.

Caution: The paper cutter is mounted on the printer cover. Be careful not to cut yourself.

When not using the take-up spool (using as receipt paper):

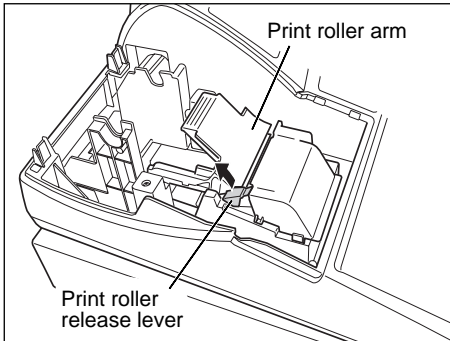

1. Remove the printer cover.
2. Lift up the print roller release lever to unlock and open the print roller arm.
3. Remove the paper roll from the paper roll cradle.

Note Do not pull the paper through the printer.

When using the take-up spool (using as journal paper):

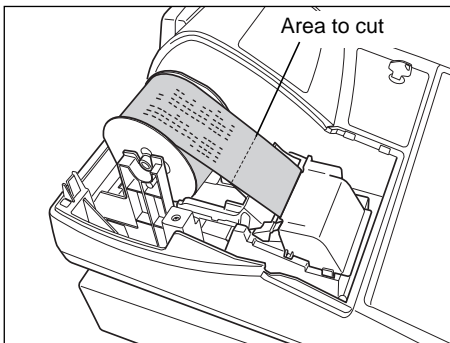

1. Turn the mode switch to a position other than "⏻" with the power cord connected.
2. Remove the printer cover.
3. Press the  key to advance the journal paper until its printed part is out of the way.
4. Cut the paper and remove the take-up spool.
5. Lift up the print roller release lever to unlock and open the print roller arm.
6. Remove the paper roll from the paper roll cradle.

Note Do not pull the paper through the printer.

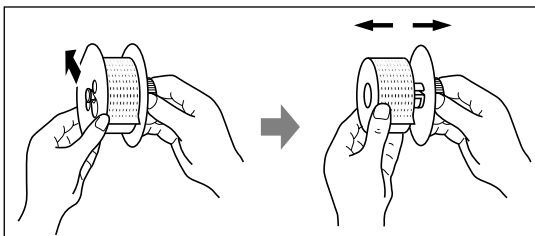

7. Remove the outer side of the take-up spool as shown on the left.
8. Remove the printed journal roll from the take-up spool.

■ Installing the paper roll

Caution: The paper cutter is mounted on the printer cover. **Be careful not to cut yourself.**

Installing the receipt paper roll:

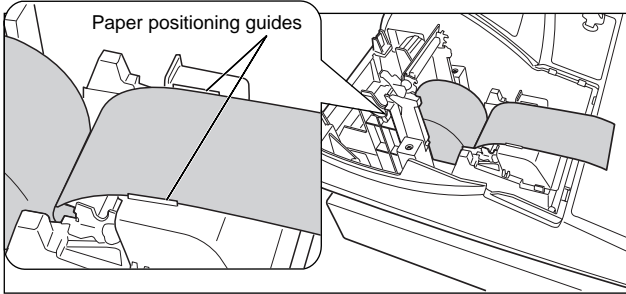

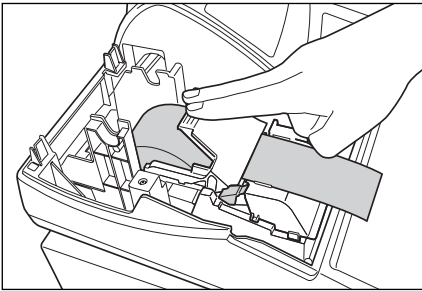

1. Turn the mode switch to a position other than “⏻” with the power cord connected.
2. Remove the printer cover.
3. Lift up the print roller release lever to unlock and open the print roller arm.
4. Set the paper correctly in the paper roll cradle.
5. Feed the end of the paper along with the paper positioning guides.

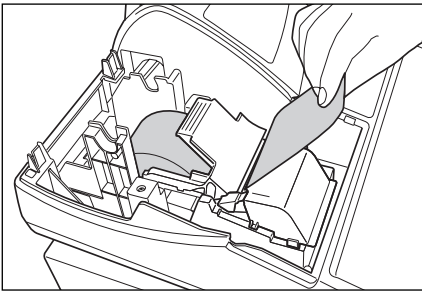

6. While holding down the paper, slowly close the print roller arm, and push down the arm until you hear a click locking the arm. Make sure securely you push down the center of the wing part of the arm as per the diagram. The paper will be fed automatically.

Note *If the print roller arm is not securely locked, printing is not done right. If this problem occurs, open the arm, and close the arm as instructed above.*



7. Cut off the excess paper using the edge of the inner cover, and replace the printer cover. Press the  key to make sure the paper end comes out of the printer cover and clean paper appears.

Note *If the paper end does not come out, open the printer cover, and pass the paper end between the paper cutter and the paper guide of the printer cover, and replace the cover.*

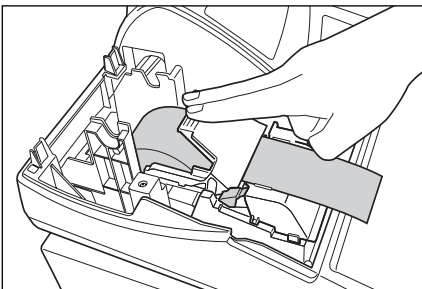

Installing the journal paper roll:

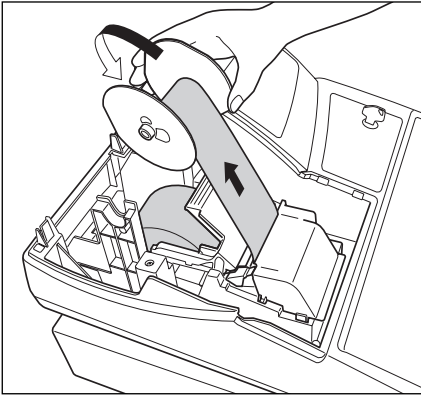

1. Turn the mode switch to a position other than “⏻” with the power cord connected.
2. Remove the printer cover.
3. Lift up the print roller release lever to unlock and open the print roller arm.
4. Set the paper correctly in the paper roll cradle.
5. Feed the end of the paper along with the paper positioning guides.
6. While holding down the paper, slowly close the print roller arm, and push down the arm until you hear a click locking the arm. Make sure securely you push down the center of the wing part of the arm as per the diagram. The paper will be fed automatically.

Note *If the print roller arm is not securely locked, printing is not done right. If this problem occurs, open the arm, and close the arm as instructed above.*



7. Insert the end of the paper into the slit in the spool. (Press the  key to feed more paper if required.)
8. Wind the paper two or three turns around the spool shaft.
9. Set the spool on the bearing, and press the  key to take up excess slack in the paper.
10. Replace the printer cover.

Note

You can wind the roll paper in OP X/Z, X1/Z1, and X2/Z2 modes even if you programmed so that the printer is used for issuance of receipts. This may be convenient to wind reports. In this case, set the roll paper to the take-up spool.

6 Removing a Paper Jam

Caution: The paper cutter is mounted on the printer cover. Be careful not to cut yourself. Never touch the print head immediately after printing, as the head may still be hot.

1. Remove the printer cover.
2. Lift up the print roller release lever to unlock and open the print roller arm.
3. Remove the paper jam. Check for and remove any shreds of paper that may remain in the printer.
4. Reset the paper roll correctly by following the steps in "Installing the paper roll".

7 Cleaning the Printer (Print Head / Sensor / Roller)

When the printed text is getting dark or faint, paper dust may be stuck to the print head, sensor and/or roller. Clean them as follows:

Caution:

- Never touch the print head with a tool or anything hard as it may damage the head.
- The paper cutter is mounted on the printer cover. Be careful not to cut yourself.

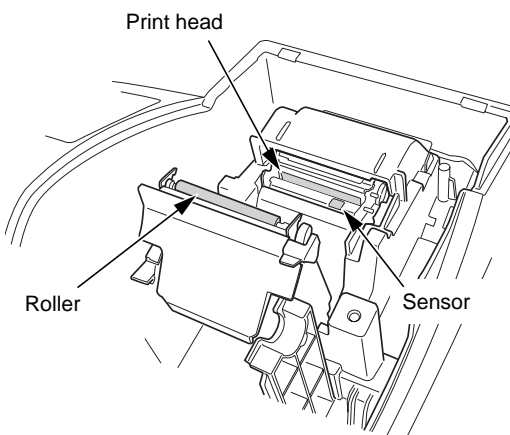

1. Turn the mode switch to the "ϕ" position.
2. Remove the printer cover.
3. Lift up the print roller release lever to unlock and open the print roller arm.
4. Remove the paper roll referring to the "Removing the paper roll" section.
5. Clean the print head with a cotton swab or soft rag moistened with ethyl alcohol or isopropyl alcohol. Clean the roller and the sensor in the same manner.
6. Reset the paper roll correctly by following the steps in "Installing the paper roll".

8 Removing the Till and the Drawer

The till in the register is detachable. After closing your business for the day, remove the till from the drawer and keep the drawer open. The 8-denomination coin case is also detachable from the till. To detach the drawer, pull it forward fully with the till removed, and remove it by lifting it up.

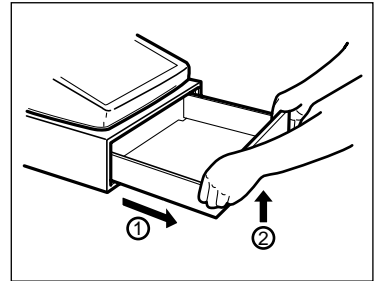
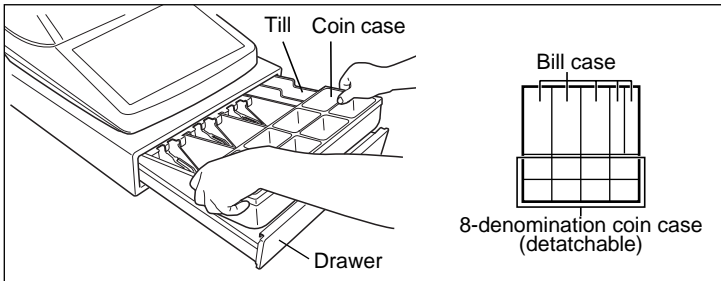

9 Opening the Drawer by Hand

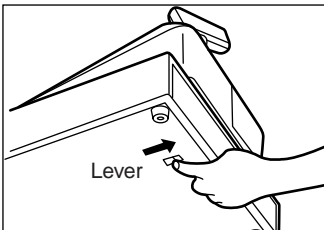

The drawer automatically opens. However, when a power failure occurs or the machine becomes out of order, slide the lever located on the bottom of the machine in the direction of the arrow. (See the diagram at the left.) The drawer will not open if it is locked with the key.



10 Before Calling for Service

The malfunctions shown in the left-hand column below, labelled “Fault,” do not necessarily indicate functional faults of the machine. It is therefore advisable to refer to “Checking” shown in the right-hand column before calling for service.

| Fault | Checking |
|--|--|
| (1) The display shows symbols that do not make sense. | <ul style="list-style-type: none"> • Has the machine been initialized properly as shown in “GETTING STARTED”? (Note that initialization clears all the data and programmed settings stored in memory.) |
| (2) The display won't illuminate even when the mode switch is turned to any other position than “  ”. | <ul style="list-style-type: none"> • Is power supplied to the electrical outlet? • Is the power cord plug out or loosely connected to the AC outlet? |
| (3) The display is illuminated, but the whole machine refuses registrations. | <ul style="list-style-type: none"> • Is a clerk code assigned to the register? • Is the mode switch set properly at the “REG” position? |
| (4) No receipt is issued. | <ul style="list-style-type: none"> • Is the paper roll properly installed? • Is there a paper jam? • Is the receipt function in the “OFF” status? • Is the print roller arm securely locked? |
| (5) No journal paper is taken up. | <ul style="list-style-type: none"> • Is the take-up spool installed on the bearing properly? • Is there a paper jam? |
| (6) Printing is unusual. | <ul style="list-style-type: none"> • Is the print roller arm securely locked? Open the print roller arm, and lock the arm by following the instruction of installation. • Is the paper roll properly installed? • Are the print head/sensor/roller clean? |
| (7) Continuous printing stops. | <ul style="list-style-type: none"> • Display shows “→ → → → →”. Printing will automatically restart after several seconds. |

■ Error message table

When the following error messages are displayed, press the  key and take a proper action according to the table below.

| Error message | Error status | Action |
|---------------|--|--|
| ENTRY ERROR | Registration error | Make a correct key entry. |
| MISOPERATION | Misoperation error | Make a correct key entry. |
| NO RECORD | Undefined code is entered. | Enter a correct code. |
| MEMORY FULL | Memory is full (in the AUTO key programming). | Program the AUTO key within 25 steps. |
| SBTL COMPUL. | Compulsory depression of the  key for direct finalization | Press the  key and continue the operation. |
| TEND COMPUL. | Compulsory tendering | Make a tendering operation. |
| NOT ASSIGNED | No entry of a clerk code | Make a clerk code entry. |
| OVER LIMIT. | Overflow limitation error | Make a registration within a limit of entry. |
| INH. OPEN PR | The open price entry is inhibited. | Make a preset price entry. |
| INH. UNIT PR | The preset price entry is inhibited. | Make an open price entry. |
| NOT NON-TEND | The direct finalization is inhibited. | Make a tendering operation. |
| BUFFER FULL | 1. Subtotal void is not allowed. | Finalize the transaction, and correct the wrong entries in the  mode. |
| | 2. GLU item entries are reached to 50 items. | Finalize the transaction. |
| HEAD UP | Print roller arm is lifted up. | Make sure the print roller arm is surely rocked. |
| PAPER EMPTY | Receipt or journal paper roll is not installed or empty. | Install a receipt or journal paper. |
| EURO CHANGE | EURO modification operation must be executed | Execute EURO modification operation (Job code 800). |

SPECIFICATIONS

| | | | | | | | | | | | | | | | | | | | | | | |
|-------------------------------------|--|--|-------------|---|--------------|---|-----------------|---|------------|---|---------------|---|----------------------|---|----------------|-----------------------------|-------------------------------------|-----------------------------|-------------------|--------|--------------------|--------|
| Model: | XE-A212 | | | | | | | | | | | | | | | | | | | | | |
| Dimensions: | 421 (W) x 429 (D) x 305 (H) mm | | | | | | | | | | | | | | | | | | | | | |
| Weight: | 11.3 kg | | | | | | | | | | | | | | | | | | | | | |
| Power source: | Official (nominal) voltage and frequency | | | | | | | | | | | | | | | | | | | | | |
| Power consumption: | Stand-by: 9W (When the official voltage is 220 to 230 V) Stand-by: 9.6W (When the official voltage is 230 to 240 V) Operating: 35W (When the official voltage is 220 to 230 V) Operating: 36W (When the official voltage is 230 to 240 V) | | | | | | | | | | | | | | | | | | | | | |
| Working temperature: | 0 °C to 40 °C | | | | | | | | | | | | | | | | | | | | | |
| Electronics: | LSI (CPU) etc. | | | | | | | | | | | | | | | | | | | | | |
| Display: | | | | | | | | | | | | | | | | | | | | | | |
| Operator display: | Dot matrix display (16 positions and 2 lines) | | | | | | | | | | | | | | | | | | | | | |
| Customer display: | 7-segment display (7 positions) | | | | | | | | | | | | | | | | | | | | | |
| Printer: | | | | | | | | | | | | | | | | | | | | | | |
| Type: | One-station thermal printer | | | | | | | | | | | | | | | | | | | | | |
| Printing speed: | Approx. 12 lines/second | | | | | | | | | | | | | | | | | | | | | |
| Printing capacity: | 24 digits each for receipt/journal paper | | | | | | | | | | | | | | | | | | | | | |
| Other functions: | <ul style="list-style-type: none">• Graphic logo printing function• Logo message function• Receipt (ON-OFF) function• Compression print for journal | | | | | | | | | | | | | | | | | | | | | |
| Paper roll: | Width: 57.5 ± 0.5 mm Max. diam.: 80 mm Quality: High quality (0.06 to 0.08 mm thickness) | | | | | | | | | | | | | | | | | | | | | |
| Cash drawer: | 5 slots for bill and 8 for coin denominations | | | | | | | | | | | | | | | | | | | | | |
| Accessories: | <table><tr><td>Manager key</td><td>2</td></tr><tr><td>Operator key</td><td>2</td></tr><tr><td>Drawer lock key</td><td>2</td></tr><tr><td>Paper roll</td><td>1</td></tr><tr><td>Take-up spool</td><td>1</td></tr><tr><td>Fixing angle bracket</td><td>1</td></tr><tr><td>Keyboard sheet</td><td>1 (mounted on the keyboard)</td></tr><tr><td>Keyboard sheet for text programming</td><td>1 (mounted on the keyboard)</td></tr><tr><td>Quick Start Guide</td><td>1 copy</td></tr><tr><td>Instruction manual</td><td>1 copy</td></tr></table> | | Manager key | 2 | Operator key | 2 | Drawer lock key | 2 | Paper roll | 1 | Take-up spool | 1 | Fixing angle bracket | 1 | Keyboard sheet | 1 (mounted on the keyboard) | Keyboard sheet for text programming | 1 (mounted on the keyboard) | Quick Start Guide | 1 copy | Instruction manual | 1 copy |
| Manager key | 2 | | | | | | | | | | | | | | | | | | | | | |
| Operator key | 2 | | | | | | | | | | | | | | | | | | | | | |
| Drawer lock key | 2 | | | | | | | | | | | | | | | | | | | | | |
| Paper roll | 1 | | | | | | | | | | | | | | | | | | | | | |
| Take-up spool | 1 | | | | | | | | | | | | | | | | | | | | | |
| Fixing angle bracket | 1 | | | | | | | | | | | | | | | | | | | | | |
| Keyboard sheet | 1 (mounted on the keyboard) | | | | | | | | | | | | | | | | | | | | | |
| Keyboard sheet for text programming | 1 (mounted on the keyboard) | | | | | | | | | | | | | | | | | | | | | |
| Quick Start Guide | 1 copy | | | | | | | | | | | | | | | | | | | | | |
| Instruction manual | 1 copy | | | | | | | | | | | | | | | | | | | | | |

* Specifications and appearance subject to change without notice for improvement.

SHARP®
SHARP CORPORATION