

Features

- AEC-Q100 qualified for automotive application
- Temperature Grade 1: -40°C to 125°C Ambient Operating Temperature Range
- Device HBM ESD Classification Level Class3A
- Operating Voltage: 4.5V~45V
- Adjustable and 5.0V Versions
- Minimum Drop Out 1.5V
- Fixed 150KHz Switching Frequency
- 2A Constant Output Current Capability
- Internal Optimize Power Transistor
- TTL shutdown capability
- Built in thermal shutdown function
- Built in current limit protection function
- Built in output short protection function
- Available in SOP8-EP package

General Description

The XL1509Q is an AEC-Q100 qualified , 150 KHz fixed frequency buck DC/DC converter, capable of driving a 2A load with high voltage, high efficiency. The XL1509Q supports wide input operating voltage range of 4.5V ~ 45V and a maximum duty cycle of 100% output. A built-in loop compensation module reduces components in the system, lowering power system cost and reducing printed circuit board space.

The XL1509Q is available in adjustable and fixed 5.0V versions. The XL1509Q has built-in thermal shutdown, current limit protection and output short protection function and so on. When the output short protection function happens, the operation frequency will be reduced about from 150KHz to 30KHz.

Applications

- Vehicle Mounted Device
- Industrial and Motor Control
- Networking Equipment

Typical application schematic

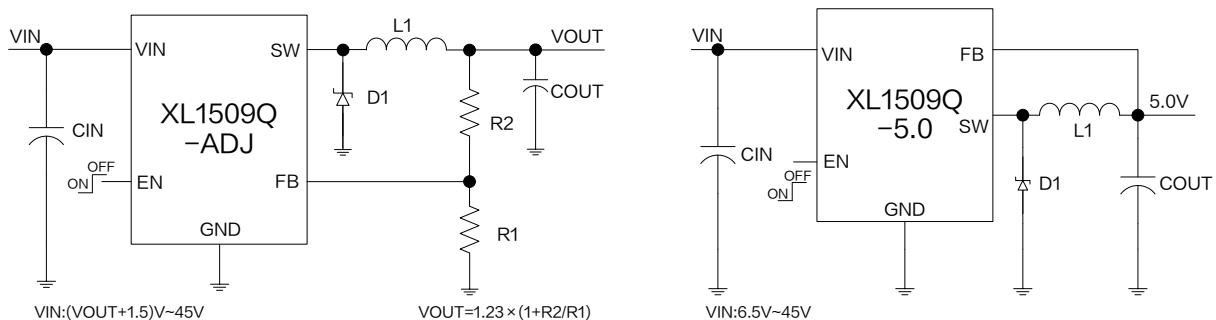

Figure1.XL1509Q Typical application schematic

Pin Configurations

VIN	1	8	GND
SW	2	7	GND
FB	3	6	GND
EN	4	5	GND

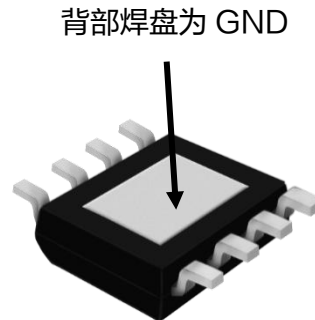

Figure2. Pin Configuration of XL1509Q

Table 1. Pin Description

Pin Number	Pin Name	Description
1	VIN	Supply Voltage Input Pin. XL1509Q DC operating voltage range from a 4.5V to 45V. Bypass VIN to GND with a suitably large capacitor to eliminate noise on the input.
2	SW	Power Switch Output Pin (SW). Output is the switch node that supplies power to the output.
3	FB	Feedback Pin (FB). Through an external resistor divider network, detects the output voltage for adjustment, with an adjustable version reference voltage of 1.23V.
4	EN	Enable Pin. Drive EN pin low to turn on the device, drive it high to turn it off. Floating is default low.
5~8	GND	Ground Pin.

Ordering Information

Order Information	Marking ID	Package Type	Eco Plan	Packing Type Supplied As
XL1509Q-ADJ	XL1509Q-ADJ	SOP8-EP	RoHS & HF	4000 Units on Reel
XL1509Q-5.0	XL1509Q-5.0	SOP8-EP	RoHS & HF	4000 Units on Reel

Function Block

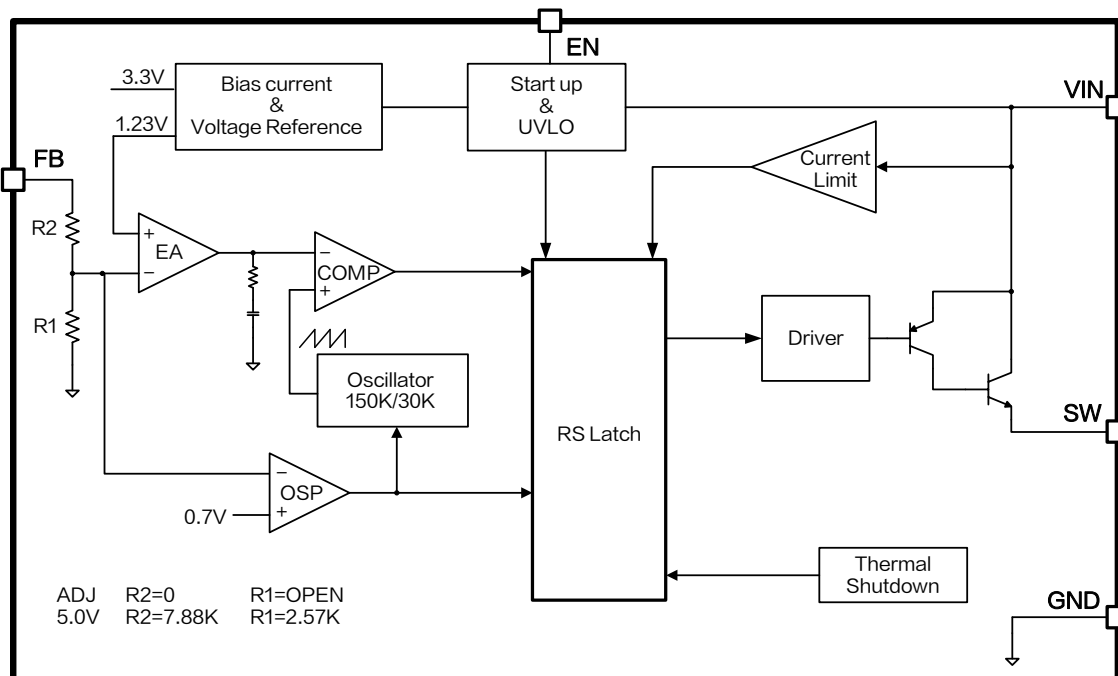

Figure3. Function Block Diagram of XL1509Q

Absolute Maximum Ratings(Note1)

Parameter	Symbol	Value	Unit
Input Voltage	V_{IN}	-0.3~50	V
Feedback Pin Voltage	V_{FB}	-0.3~20	V
EN Pin Voltage	V_{EN}	-0.3~7	V
Output Switch Pin Voltage	V_{SW}	-0.3~ V_{IN}	V
Thermal Resistance (SOP8-EP) (Junction to Ambient, No Heatsink, Free Air)	R_{JA}	60	°C/W
Operating Junction Temperature	T_J	-40~150	°C
Storage Temperature	T_{STG}	-40~150	°C
Lead Temperature (Soldering, 10 sec)	T_{LEAD}	260	°C

Note1: Stresses greater than those listed under Maximum Ratings may cause permanent damage to the device. This is a stress rating only and functional operation of the device at these or any other conditions above those indicated in the operation is not implied. Exposure to absolute maximum rating conditions for extended periods may affect reliability.

150KHz 45V 2A AEC-Q100 Buck DC to DC Converter

XL1509Q

XL1509Q-ADJ ESD Characteristics

Parameters	Standard	Value	Unit
ESD (HBM)	JEDEC JS-001	± 4000	V
ESD (CDM)	JEDEC JS-002	± 1000	V

XL1509Q-5.0 ESD Characteristics

Parameters	Standard	Value	Unit
ESD (HBM)	JEDEC JS-001	± 2000	V
ESD (CDM)	JEDEC JS-002	± 1000	V

Electrical Characteristics (DC Parameters)

$T_J = 25^{\circ}\text{C}$, $V_{IN} = 12\text{V}$, $V_{EN} = 0\text{V}$, System parameters test circuit figure5, unless otherwise specified.

Parameters	Symbol	Test Condition	Min.	Typ.	Max.	Unit
Operating Voltage	V_{IN}		4.5		45	V
Shutdown Current	I_S	$V_{EN} = 2\text{V}$		46	100	μA
		$V_{EN} = 2\text{V}$, $T_J = -40 \sim 150^{\circ}\text{C}$			200	μA
Quiescent Current	I_Q	$V_{FB} = 6\text{V}$		1.3	2.0	mA
		$V_{FB} = 6\text{V}$, $T_J = -40 \sim 150^{\circ}\text{C}$			2.5	mA
EN Pin Threshold Voltage	V_{EN_H}	High (Regulator OFF)		1.4		V
	V_{EN_L}	Low (Regulator ON)		0.8		V
Max. Duty Cycle	D_{MAX}	$V_{FB} = 0\text{V}$		100		%

Typical System Application Schematic for ADJ Version

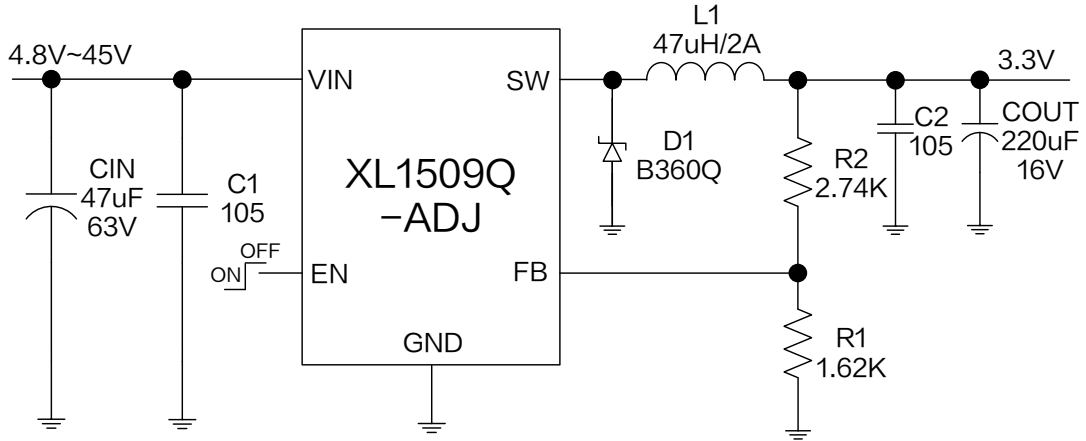

Figure4. XL1509Q-ADJ System Parameters Test Circuit($V_{OUT}=3.3V$)

Typical System Application Recommend Operation Area

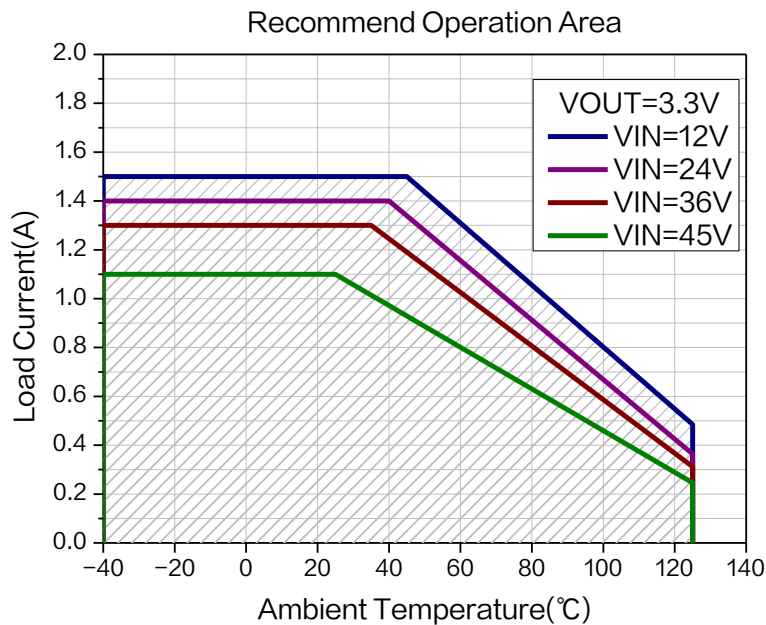

Figure5. XL1509Q-ADJ Recommend Operation Area($V_{OUT}=3.3V$)

150KHz 45V 2A AEC-Q100 Buck DC to DC Converter

XL1509Q

XL1509Q-ADJ Electrical Characteristics

$V_{IN}=12V$, $V_{OUT}=3.3V$, $I_{OUT}=0.5A$; System parameters test circuit figure4 and Recommend operation area figure5, unless otherwise specified.

Symbol	Parameter	Test Condition	Min.	Typ.	Max.	Unit
V_{FB}	Feedback Voltage	$T_J=25^{\circ}C$	1.212	1.230	1.248	V
		$T_J=-40\sim 150^{\circ}C$	1.199	-	1.261	V
F_{OSC}	Oscillator Frequency	$T_J=25^{\circ}C$	135	150	165	KHz
		$T_J=-40\sim 150^{\circ}C$	120	-	180	KHz
$ \Delta V_{FB} $	Line Regulation	$V_{IN}=6V\sim 45V, T_J=25^{\circ}C$	-	-	1.0	%
$ \Delta V_{FB} $	Load Regulation	$I_{OUT}=0.1\sim 1.5A, T_J=25^{\circ}C$	-	-	1.0	%
η	Efficiency	$T_A=25^{\circ}C$	-	80.5	-	%

Typical System Application Transfer Efficiency

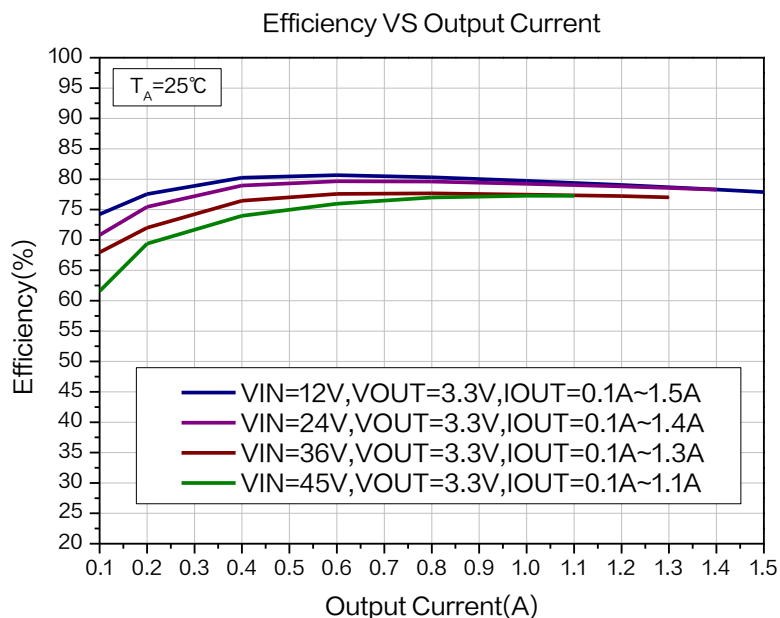

Figure6. XL1509Q-ADJ System Efficiency Curve

Typical System Application Schematic for 5.0V Version

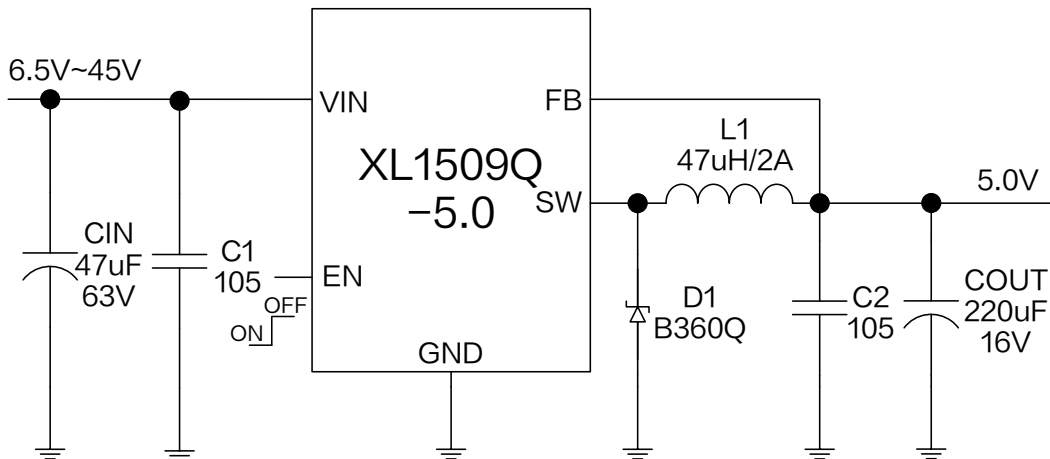

Figure7. XL1509Q-5.0 System Parameters Test Circuit

Typical System Application Recommend Operation Area

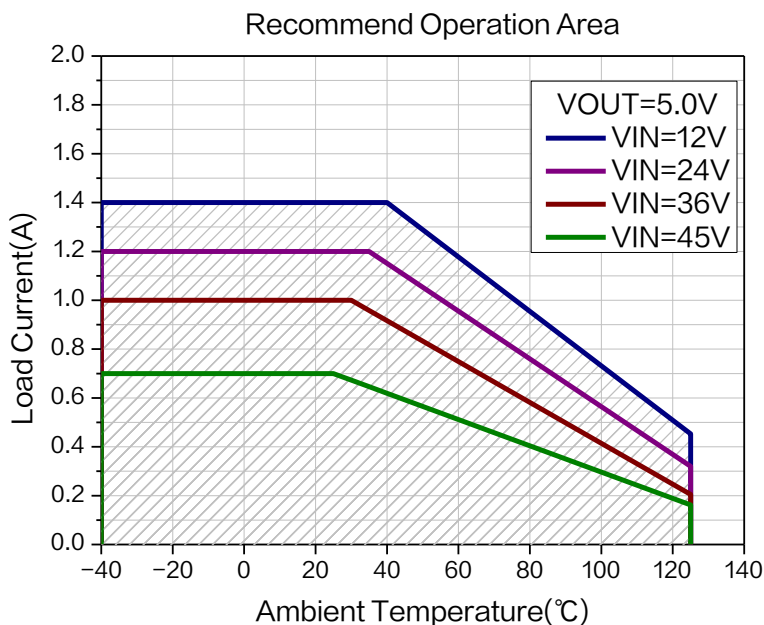

Figure8. XL1509Q-5.0 Recommend Operation Area($V_{OUT}=5.0V$)

XL1509Q-5.0 Electrical Characteristics

$V_{IN}=12V$, $V_{OUT}=5.0V$, $I_{OUT}=0.5A$; System parameters test circuit figure7 and Recommend operation area figure8, unless otherwise specified.

Symbol	Parameter	Test Condition	Min.	Typ.	Max.	Unit
V_{OUT}	Output Voltage	$T_J=25^{\circ}C$	4.925	5.000	5.075	V
		$T_J=-40\sim 150^{\circ}C$	4.875	-	5.125	V
F_{OSC}	Oscillator Frequency	$T_J=25^{\circ}C$	135	150	165	KHz
		$T_J=-40\sim 150^{\circ}C$	120	-	180	KHz
$ \Delta V_{FB} $	Line Regulation	$V_{IN}=6V\sim 45V, T_J=25^{\circ}C$	-	-	1.0	%
$ \Delta V_{FB} $	Load Regulation	$I_{OUT}=0.1\sim 1.5A, T_J=25^{\circ}C$	-	-	1.0	%
η	Efficiency	$T_A=25^{\circ}C$	-	84.3	-	%

Typical System Application Transfer Efficiency

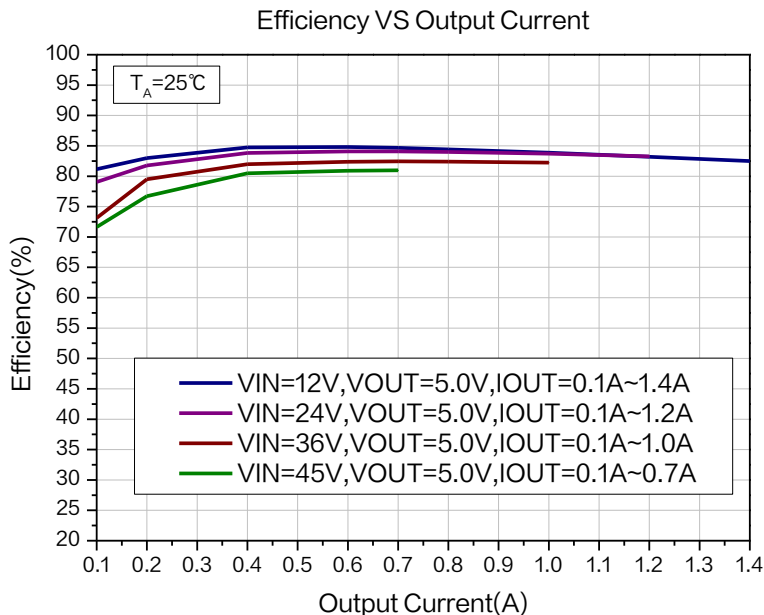

Figure9. XL1509Q-5.0 System Efficiency Curve

Typical Characteristics

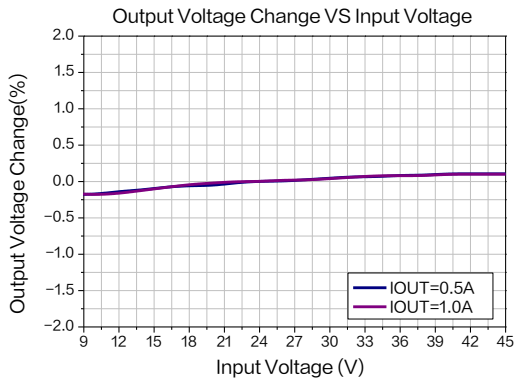

Figure10.Line Regulation

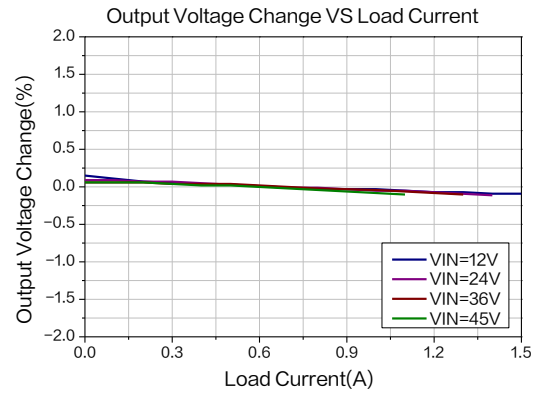

Figure11.Load Regulation

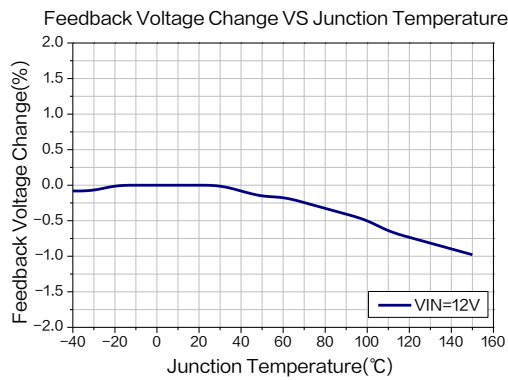

Figure12.Feedback Voltage Regulation

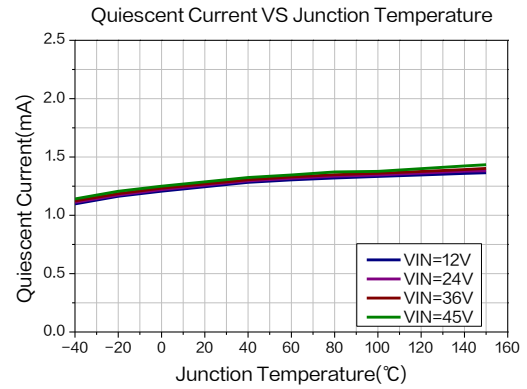

Figure13. Quiescent Current

150KHz 45V 2A AEC-Q100 Buck DC to DC Converter

XL1509Q

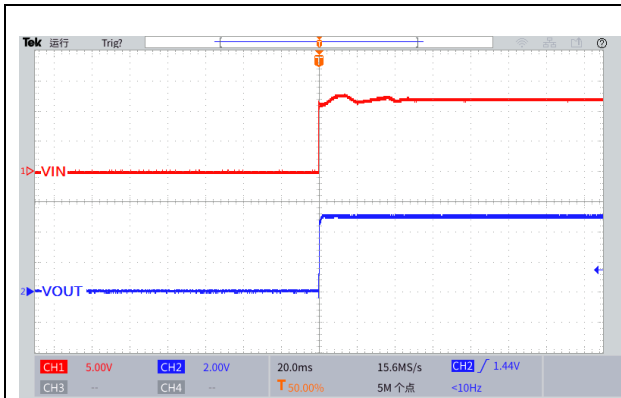

Figure 14. Start-Up Characteristic
($V_{IN}=12V$, $V_{OUT}=5.0V$, $I_{OUT}=0.1A$)

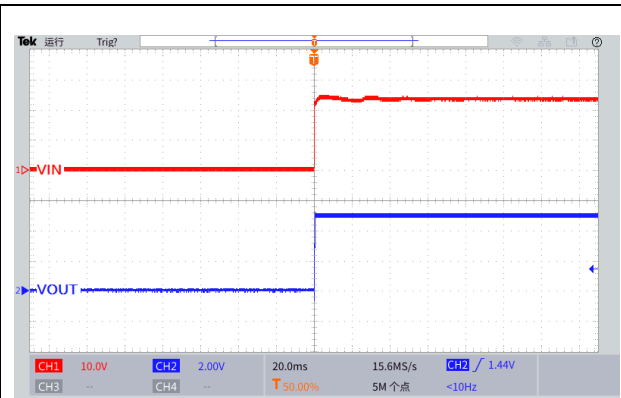

Figure 15. Start-Up Characteristic
($V_{IN}=24V$, $V_{OUT}=5.0V$, $I_{OUT}=0.1A$)

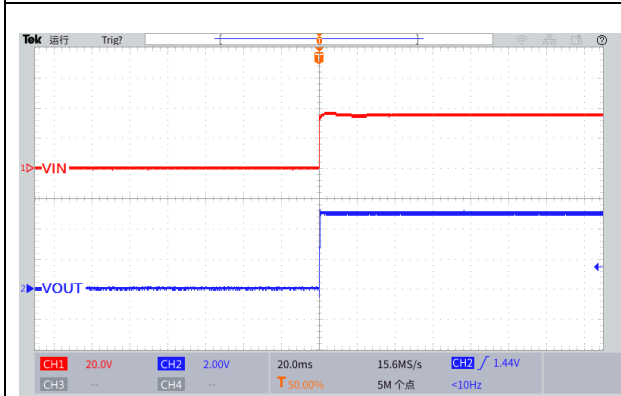

Figure 16. Start-Up Characteristic
($V_{IN}=36V$, $V_{OUT}=5.0V$, $I_{OUT}=0.1A$)

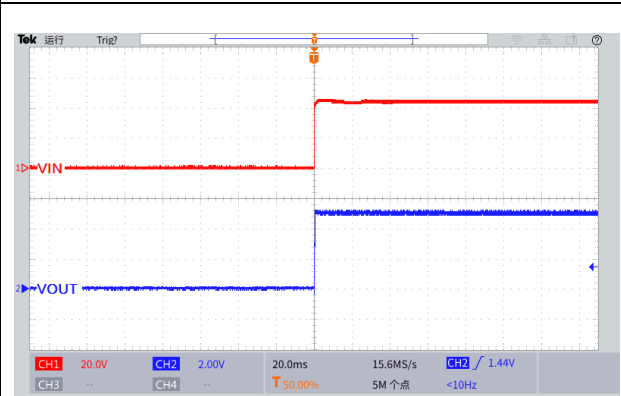

Figure 17. Start-Up Characteristic
($V_{IN}=45V$, $V_{OUT}=5.0V$, $I_{OUT}=0.1A$)

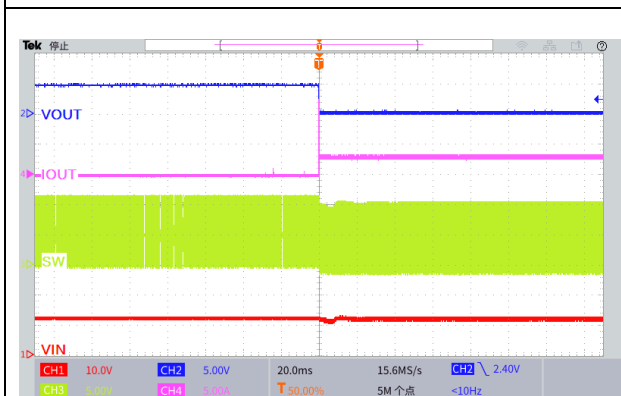

Figure 18. Output Short Circuit Waveform
($V_{IN}=12V$, $V_{OUT}=5.0V$)

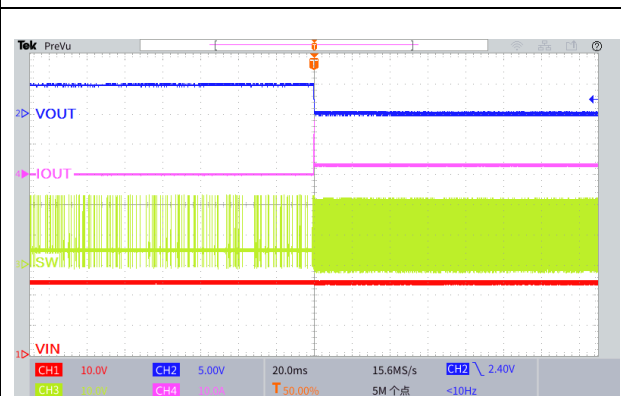

Figure 19. Output Short Circuit Waveform
($V_{IN}=24V$, $V_{OUT}=5.0V$)

150KHz 45V 2A AEC-Q100 Buck DC to DC Converter

XL1509Q

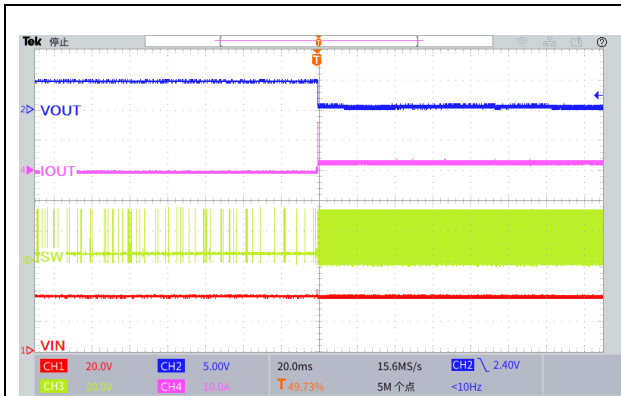

Figure 20. Output Short Circuit Waveform
($V_{IN}=36V$, $V_{OUT}=5.0V$)

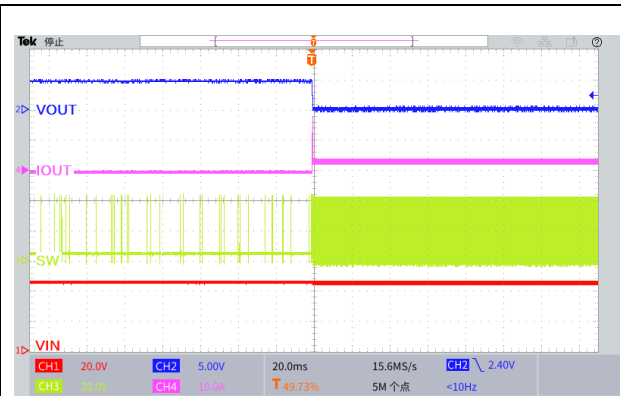

Figure 21. Output Short Circuit Waveform
($V_{IN}=45V$, $V_{OUT}=5.0V$)

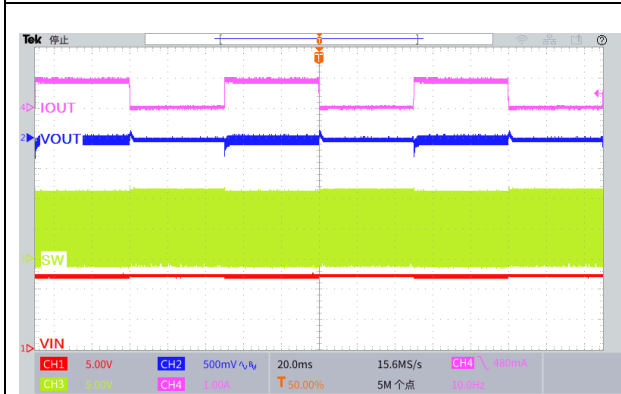

Figure 22. Load Transient Response
($V_{IN}=12V$, $V_{OUT}=5.0V$, $I_{OUT}=0.1$ to $1A$)

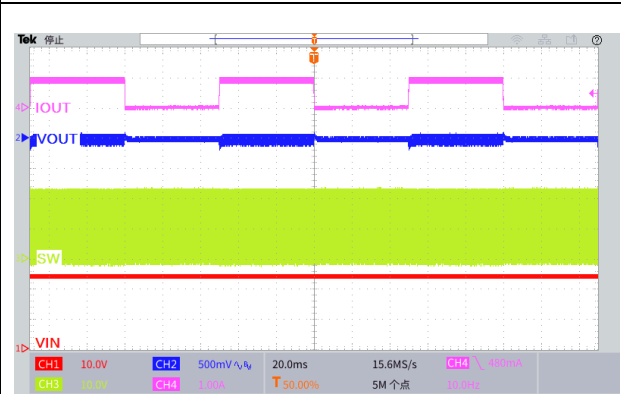

Figure 23. Load Transient Response
($V_{IN}=24V$, $V_{OUT}=5.0V$, $I_{OUT}=0.1$ to $1A$)

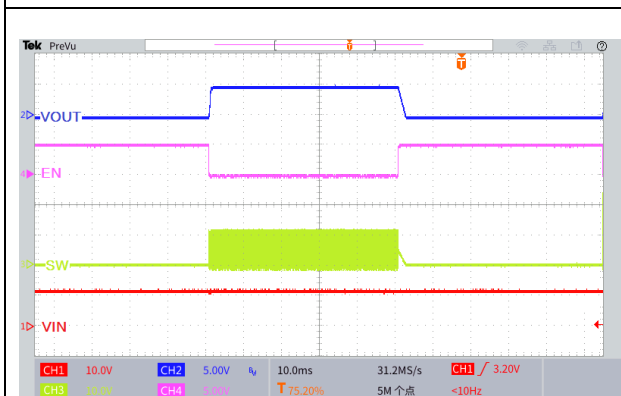

Figure 24. Start or Shutdown Using EN Pin
($V_{IN}=12V$, $F_{EN}=10Hz$, $V_{OUT}=5.0V$, $I_{OUT}=0.5A$)



Figure 25. Start or Shutdown Using EN Pin
($V_{IN}=24V$, $F_{EN}=10Hz$, $V_{OUT}=5.0V$, $I_{OUT}=0.5A$)

Reliability Parameter Indicator (Note 2)

Thermal shutdown function

To prevent damage to the chip due to overheating, the XL1509Q is designed with thermal shutdown protection. When the junction temperature of the chip exceeds 170°C, it will enter the thermal shutdown state and turn off the output. When the temperature drops to 40°C below the threshold, the chip will automatically resume operation.

Current limit protection function

The switching current limit prevents excessive currents that may be generated if the inductor is saturated or the output circuit is overloaded. The XL1509Q is designed with current-limit protection, and the output current is limited to about 3A, as shown in Figure 26.

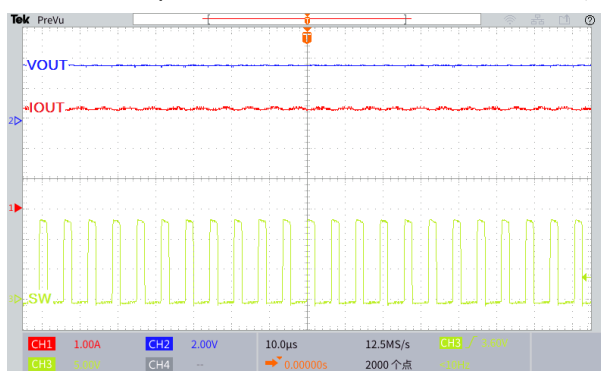

Figure26. Output current limiting waveform ($V_{IN}=12V$, V_{OUT} set to 5.0V)

Output short protection function

In order to avoid the output short circuit and damage the chip, XL1509Q is designed with a short circuit protection function. When an output short circuit is detected and the short circuit protection function is enabled, the switching frequency is reduced from 150KHz to about 30KHz, which reduces the output voltage and limits the output current, as shown in Figure 27.

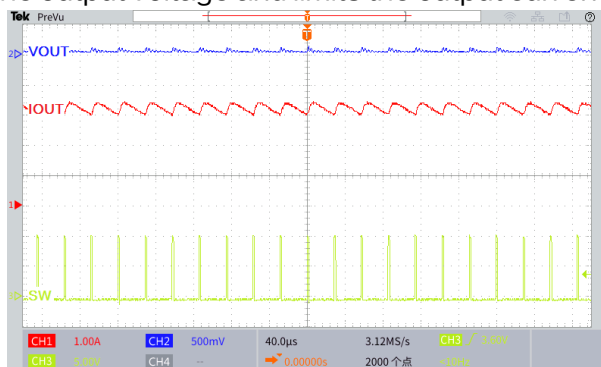
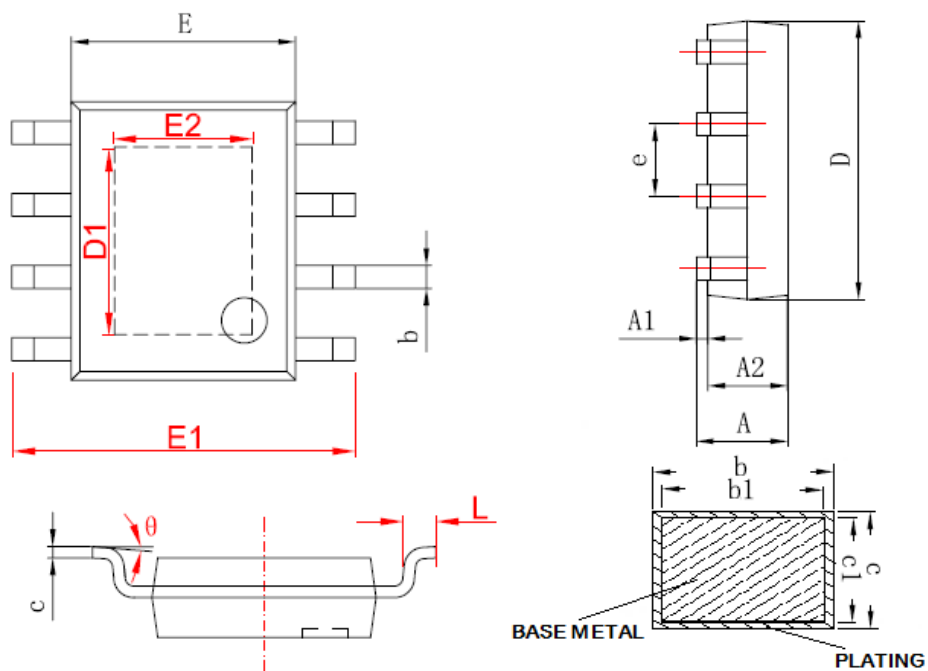

Figure26. Output short circuit waveform ($V_{IN}=12V$, V_{OUT} set to 5.0V)

Note2: Reliability parameter indicators are guaranteed by one or more of the methods of production testing, characterization, or design.

Package Information

SOP8-EP



Symbol	Dimensions In Millimeters		Dimensions In Inches	
	Min.	Max.	Min.	Max.
A	1.350	1.750	0.053	0.069
A1	0.000	0.150	0.000	0.006
A2	1.250	1.650	0.049	0.065
b	0.306	0.510	0.012	0.020
b1	0.296	0.480	0.011	0.019
c	0.170	0.250	0.006	0.010
c1	0.170	0.230	0.006	0.009
D	4.700	5.100	0.185	0.200
D1	2.650	3.467	0.104	0.136
E	3.800	4.000	0.150	0.157
E1	5.800	6.200	0.228	0.244
E2	1.930	2.534	0.076	0.100
e	1.140	1.400	0.045	0.055
L	0.450	0.800	0.017	0.031
θ	0°	8°	0°	8°

150KHz 45V 2A AEC-Q100 Buck DC to DC Converter	XL1509Q
--	---------

Important Notice

XLSEMI reserve the right to make modifications, enhancements, improvements, corrections or other changes without notice at any time. XLSEMI does not assume any liability arising out of the application or use of any product described herein; neither does it convey any license under its patent rights, nor the rights of others. XLSEMI assumes no liability for applications assistance or the design of Buyers' products. Buyers are responsible for their products and applications using XLSEMI components. To minimize the risks associated with Buyers' products and applications, Buyers should provide adequate design and operating safeguards. XLSEMI warrants performance of its products to the specifications applicable at the time of sale, in accordance with the warranty in XLSEMI's terms and conditions of sale of semiconductor products. Testing and other quality control techniques are used to the extent XLSEMI deems necessary to support this warranty. Except where mandated by applicable law, testing of all parameters of each component is not necessarily performed.

For the latest product information, go to www.xlsemi.com.