

36.0-40.0 GHz GaAs MMIC Power Amplifier

May 2006 - Rev 10-May-06

Features

- X Excellent Linear Output Amplifier Stage
- X 21.0 dB Small Signal Gain
- X +36.0 dBm Third Order Intercept (OIP3)
- X +27.0 dBm Output P1dB Compression Point
- X 100% On-Wafer RF, DC and Output Power Testing
- X 100% Visual Inspection to MIL-STD-883 Method 2010

Chip Device Layout

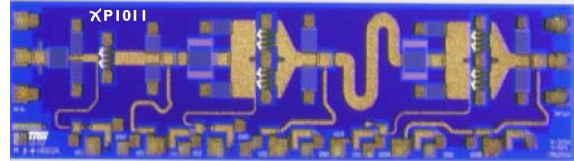

General Description

Mimix Broadband's three stage 36.0-40.0 GHz GaAs MMIC power amplifier is optimized for linear operation with a third order intercept point of +36.0 dBm. This MMIC uses Mimix Broadband's 0.15 μm GaAs PHEMT device model technology, and is based upon electron beam lithography to ensure high repeatability and uniformity. The chip has surface passivation to protect and provide a rugged part with backside via holes and gold metallization to allow either a conductive epoxy or eutectic solder die attach process. This device is well suited for Millimeter-wave Point-to-Point Radio, LMDS, SATCOM and VSAT applications.

Absolute Maximum Ratings

Supply Voltage (Vd)	+5.5 VDC
Supply Current (Id1,2,3)	155,415,715 mA
Gate Bias Voltage	+0.3 VDC
Input Power (Pin)	+8 dBm
Storage Temperature (Tstg)	-65 to +165 °C
Operating Temperature (Ta)	-55 to MTTF Table ³
Channel Temperature (Tch)	MTTF Table ³

(3) Channel temperature affects a device's MTTF. It is recommended to keep channel temperature as low as possible for maximum life.

Electrical Characteristics (Ambient Temperature T = 25 °C)

Parameter	Units	Min.	Typ.	Max.
Frequency Range (f)	GHz	36.0	-	40.0
Input Return Loss (S11)	dB	-	10.0	-
Output Return Loss (S22)	dB	-	9.0	-
Small Signal Gain (S21)	dB	-	21.0	-
Gain Flatness ($\Delta S21$)	dB	-	+/-0.5	-
Reverse Isolation (S12)	dB	-	-	-
Output Power for 1 dB Compression (P1dB) ²	dBm	-	+27.0	-
Output Third Order Intercept Point (OIP3) ^{1,2}	dBm	-	+36.0	-
Drain Bias Voltage (Vd1,2,3)	VDC	-	+5.0	-
Gate Bias Voltage (Vg1,2,3)	VDC	-1.0	-0.5	0.0
Supply Current (Id) (Vd=5.0V, Vg=-0.5V Typical)	mA	-	640	-

(1) Measured at +18 dBm per tone output carrier level across the full frequency band.

(2) Measured using constant current.

36.0-40.0 GHz GaAs MMIC Power Amplifier

Power Amplifier Measurements

Measured Performance Characteristics (Typical Performance at 25°C)

Vd1 = Vd2 = Vd3 = 5 V, Id1 = 100 mA, Id2 = Id3 = 270 mA

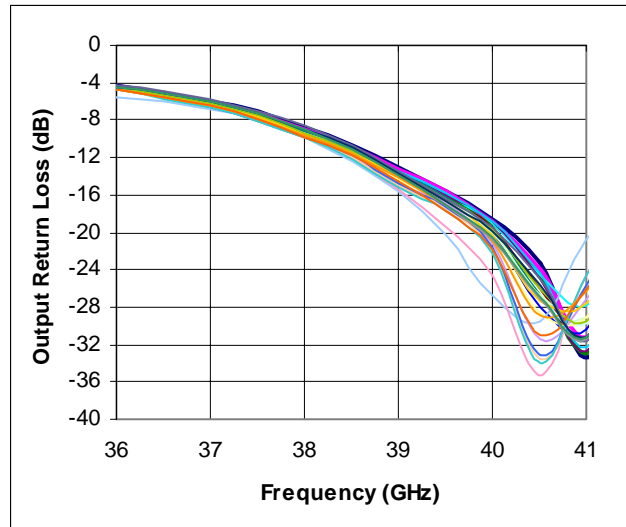
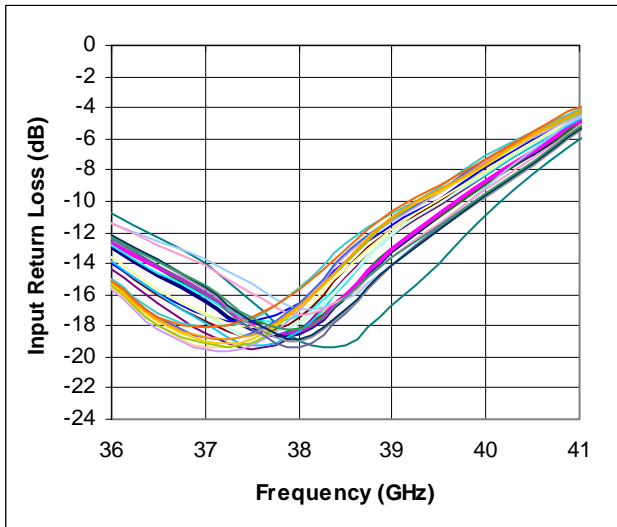
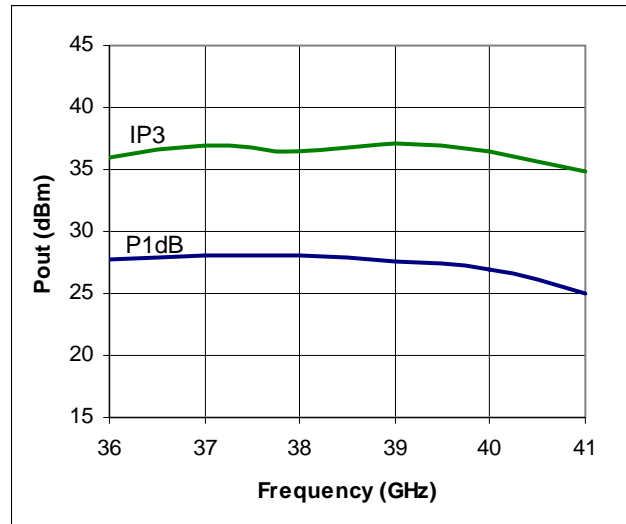
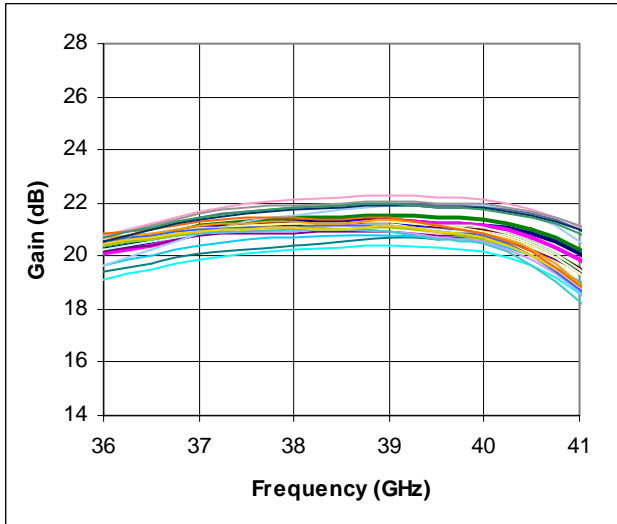

36.0-40.0 GHz GaAs MMIC Power Amplifier

May 2006 - Rev 10-May-06

S-Parameters

Measured Performance Characteristics (Typical Performance at 25°C)

Vd1 = Vd2 = Vd3 = 5 V, Id1 = 100 mA, Id2 = Id3 = 270 mA

Freq GHz	S11 Mag	S11 Ang	S21 Mag	S21 Ang	S12 Mag	S12 Ang	S22 Mag	S22 Ang
36	0.257	169.682	9.752	17.572	0	88.316	0.7	154.857
36.5	0.219	157.254	10.085	-6.541	0.001	137.979	0.672	149.661
37	0.189	139.742	10.462	-30.842	0.001	149.628	0.634	144.58
37.5	0.163	113.77	10.644	-55.166	0.001	141.639	0.585	139.033
38	0.152	80.829	10.783	-79.904	0.002	138.863	0.528	134.176
38.5	0.178	53.538	10.781	-104.619	0.002	128.236	0.468	130.614
39	0.241	32.765	10.87	-129.024	0.002	119.139	0.409	128.032
39.5	0.304	16.271	10.802	-154.302	0.002	132.162	0.362	126.503
40	0.376	2.791	10.806	179.147	0.002	114.772	0.322	124.381
40.5	0.455	-8.622	10.596	151.874	0.003	127.58	0.28	121.51
41	0.539	-19.504	10.206	123.1	0.004	105.152	0.248	118.15
41.5	0.606	-29.153	9.615	93.208	0.004	86.51	0.217	110.228
42	0.662	-38.825	8.547	62.374	0.004	59.679	0.175	94.873

36.0-40.0 GHz GaAs MMIC Power Amplifier

May 2006 - Rev 10-May-06

Mechanical Drawing

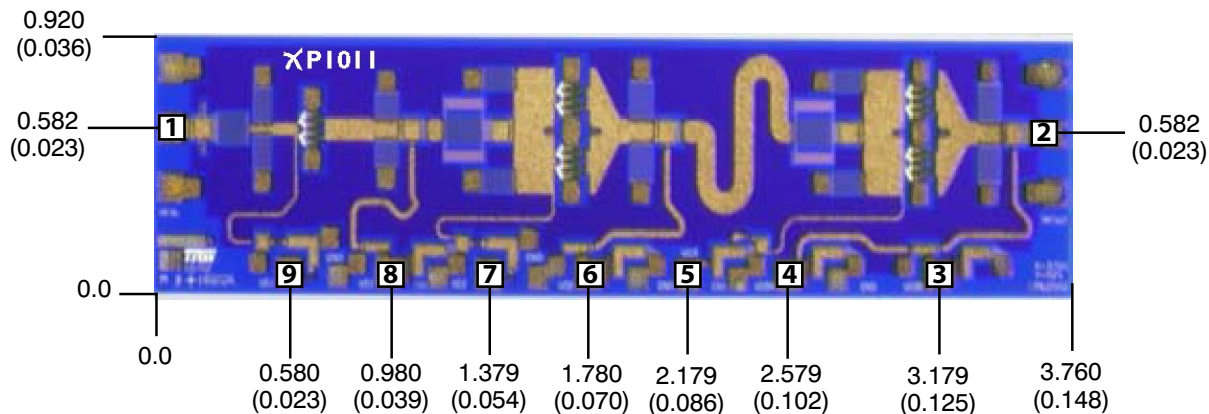

Units: millimeters (inches) Bond pad dimensions are shown to center of bond pad.
 Thickness: 0.110 +/- 0.010 (0.0043 +/- 0.0004), Backside is ground, Bond Pad/Backside Metallization: Gold
 All Bond Pads are 0.100 x 0.100 (0.004 x 0.004).
 Bond pad centers are approximately 0.109 (0.004) from the edge of the chip.
 Dicing tolerance: +/- 0.005 (+/- 0.0002). Approximate weight: 2.145 mg.

Bond Pad #1 (RF In)	Bond Pad #4 (Vd3a)	Bond Pad #7 (Vg2)
Bond Pad #2 (RF Out)	Bond Pad #5 (Vg3)	Bond Pad #8 (Vd1)
Bond Pad #3 (Vd3b)	Bond Pad #6 (Vd2)	Bond Pad #9 (Vg1)

Bias Arrangement

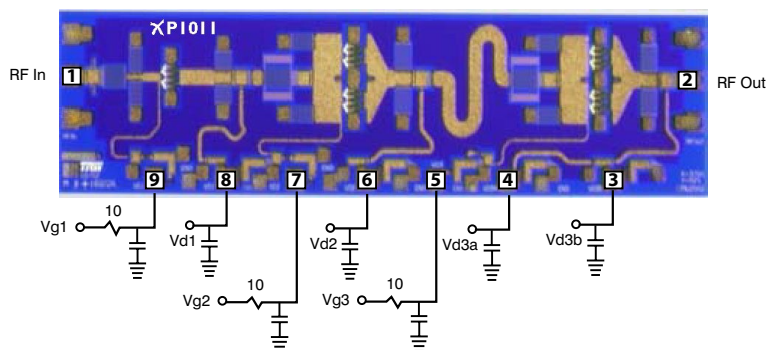

Bypass Capacitors - See App Note [2]

36.0-40.0 GHz GaAs MMIC Power Amplifier

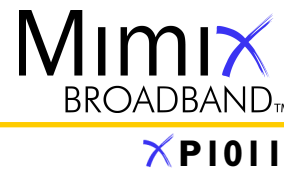

May 2006 - Rev 10-May-06

App Note [1] Biasing - It is recommended to separately bias each stage at $V_d(1,2,3)=5.0V$, $I_{d1}=100mA$, $I_{d2}=270mA$, and $I_{d3}=270mA$. It is also recommended to use active biasing to keep the currents constant as the RF power and temperature vary; this gives the most reproducible results. Depending on the supply voltage available and the power dissipation constraints, the bias circuit may be a single transistor or a low power operational amplifier, with a low value resistor in series with the drain supply used to sense the current. The gate of the pHEMT is controlled to maintain correct drain current and thus drain voltage. The typical gate voltage needed to do this is $-0.5V$. Typically the gate is protected with Silicon diodes to limit the applied voltage. Also, make sure to sequence the applied voltage to ensure negative gate bias is available before applying the positive drain supply.

App Note [2] Bias Arrangement -

For Parallel Stage Bias (Recommended for general applications) -- The same as Individual Stage Bias but all the drain or gate pad DC bypass capacitors ($\sim 100-200$ pF) can be combined. Additional DC bypass capacitance (~ 0.01 uF) is also recommended to all DC or combination (if gate or drains are tied together) of DC bias pads.

For Individual Stage Bias (Recommended for Saturated Applications) -- Each DC pad ($V_{d1,2,3}$ and $V_{g1,2,3}$) needs to have DC bypass capacitance ($\sim 100-200$ pF) as close to the device as possible. Additional DC bypass capacitance (~ 0.01 uF) is also recommended.

MTTF Table (TBD)

These numbers were calculated based on accelerated life test information and thermal model analysis received from the fabricating foundry.

Backplate Temperature	Channel Temperature	Rth	MTTF Hours	FITs
55 deg Celsius	deg Celsius	C/W	E+	E+
75 deg Celsius	deg Celsius	C/W	E+	E+
95 deg Celsius	deg Celsius	C/W	E+	E+

Bias Conditions: $V_{d1}=V_{d2}=V_{d3}=5.0V$, $I_{d1}=100$ mA, $I_{d2}=270$ mA, $I_{d3}=270$ mA

36.0-40.0 GHz GaAs MMIC Power Amplifier

May 2006 - Rev 10-May-06

Handling and Assembly Information

CAUTION! - Mimix Broadband MMIC Products contain gallium arsenide (GaAs) which can be hazardous to the human body and the environment. For safety, observe the following procedures:

- *Do not ingest.*
- *Do not alter the form of this product into a gas, powder, or liquid through burning, crushing, or chemical processing as these by-products are dangerous to the human body if inhaled, ingested, or swallowed.*
- *Observe government laws and company regulations when discarding this product. This product must be discarded in accordance with methods specified by applicable hazardous waste procedures.*

Life Support Policy - Mimix Broadband's products are not authorized for use as critical components in life support devices or systems without the express written approval of the President and General Counsel of Mimix Broadband. As used herein: (1) Life support devices or systems are devices or systems which, (a) are intended for surgical implant into the body, or (b) support or sustain life, and whose failure to perform when properly used in accordance with instructions for use provided in the labeling, can be reasonably expected to result in a significant injury to the user. (2) A critical component is any component of a life support device or system whose failure to perform can be reasonably expected to cause the failure of the life support device or system, or to affect its safety or effectiveness.

ESD - Gallium Arsenide (GaAs) devices are susceptible to electrostatic and mechanical damage. Die are supplied in antistatic containers, which should be opened in cleanroom conditions at an appropriately grounded anti-static workstation. Devices need careful handling using correctly designed collets, vacuum pickups or, with care, sharp tweezers.

Die Attachment - GaAs Products from Mimix Broadband are 0.100 mm (0.004") thick and have vias through to the backside to enable grounding to the circuit. Microstrip substrates should be brought as close to the die as possible. The mounting surface should be clean and flat. If using conductive epoxy, recommended epoxies are Ablestick 84-1LMI or 84-1LMI cured in a nitrogen atmosphere per manufacturer's cure schedule. Apply epoxy sparingly to avoid getting any on to the top surface of the die. An epoxy fillet should be visible around the total die periphery. If eutectic mounting is preferred, then a fluxless gold-tin (AuSn) preform, approximately 0.001² thick, placed between the die and the attachment surface should be used. A die bonder that utilizes a heated collet and provides scrubbing action to ensure total wetting to prevent void formation in a nitrogen atmosphere is recommended. The gold-tin eutectic (80% Au 20% Sn) has a melting point of approximately 280°C (Note: Gold Germanium should be avoided). The work station temperature should be 310°C ± 10°C. Exposure to these extreme temperatures should be kept to minimum. The collet should be heated, and the die pre-heated to avoid excessive thermal shock. Avoidance of air bridges and force impact are critical during placement.

Wire Bonding - Windows in the surface passivation above the bond pads are provided to allow wire bonding to the die's gold bond pads. The recommended wire bonding procedure uses 0.076 mm x 0.013 mm (0.003" x 0.0005") 99.99% pure gold ribbon with 0.5-2% elongation to minimize RF port bond inductance. Gold 0.025 mm (0.001") diameter wedge or ball bonds are acceptable for DC Bias connections. Aluminum wire should be avoided. Thermo-compression bonding is recommended though thermosonic bonding may be used providing the ultrasonic content of the bond is minimized. Bond force, time and ultrasonics are all critical parameters. Bonds should be made from the bond pads on the die to the package or substrate. All bonds should be as short as possible.