

# 17.0-25.0 GHz GaAs MMIC Power Amplifier, QFN

## Features

- X Excellent Transmit Output Stage
- X Temperature Compensated Output Detector
- X On-Chip ESD Protection
- X 20.0 dB Small Signal Gain
- X +28.0 dBm P1dB Compression Point
- X RoHS Compliant SMD, 4x4 mm QFN Package
- X 100% RF, DC and Output Power Testing



## General Description

Mimix Broadband's three stage 17.0-25.0 GHz GaAs MMIC buffer amplifier has a small signal gain of 20.0 dB with a +28.0 dBm P1dB output compression point across much of the band. The device also includes a temperature compensated output power detector. This MMIC uses Mimix Broadband's 0.15  $\mu\text{m}$  GaAs PHEMT device model technology, and is based upon electron beam lithography to ensure high repeatability and uniformity. The device comes in a RoHS compliant 4x4mm QFN Surface Mount Package offering excellent RF and thermal properties. This device is well suited for Millimeter-wave Point-to-Point Radio, LMDS, SATCOM and VSAT applications.

## Absolute Maximum Ratings

Supply Voltage (Vd)	+6.0 VDC
Supply Current (Id1,2,3)	145, 290, 580 mA
Gate Bias Voltage (Vg)	+0.3 VDC
Input Power (Pin)	+19.0 dBm
Storage Temperature (Tstg)	-65 to +165 °C
Operating Temperature (Ta)	-55 to MTTF Graph <sup>1</sup>
Channel Temperature (Tch)	MTTF Graph <sup>1</sup>

(1) Channel temperature affects a device's MTTF. It is recommended to keep channel temperature as low as possible for maximum life.

## Electrical Characteristics (Ambient Temperature T = 25 °C)

Parameter	Units	Min.	Typ.	Max.
Frequency Range (f)	GHz	17.0	-	25.0
Input Return Loss (S11)	dB	-	9.0	-
Output Return Loss (S22)	dB	-	10.0	-
Small Signal Gain (S21)	dB	-	20.0	-
Gain Flatness ( $\Delta S21$ )	dB	-	+/-2.0	-
Reverse Isolation (S12)	dB	-	50.0	-
Output Power for 1dB Compression (P1dB) <sup>2</sup>	dBm	-	+28.0	-
Drain Bias Voltage (Vd1,2,3) (Vdet)	VDC	-	+5.0	+5.5
Gate Bias Voltage (Vg1,2,3)	VDC	-1.0	-0.7	0.0
Supply Current (Id1) (Vd=5.0V, Vg=-0.7V Typical)	mA	-	100	120
Supply Current (Id2) (Vd=5.0V, Vg=-0.7V Typical)	mA	-	200	240
Supply Current (Id3) (Vd=5.0V, Vg=-0.7V Typical)	mA	-	400	480
Detector (diff) Output at 20 dBm <sup>3</sup>	VDC	-	0.38	-

(2) Measured using constant current.

(3) Measured with Vdet=5.0V

# 17.0-25.0 GHz GaAs MMIC Power Amplifier, QFN

November 2006 - Rev 15-Nov-06

PI022-QF  
RoHS

## Power Amplifier Measurements

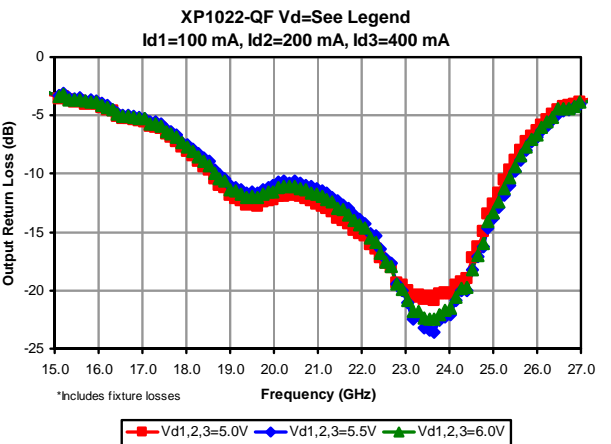
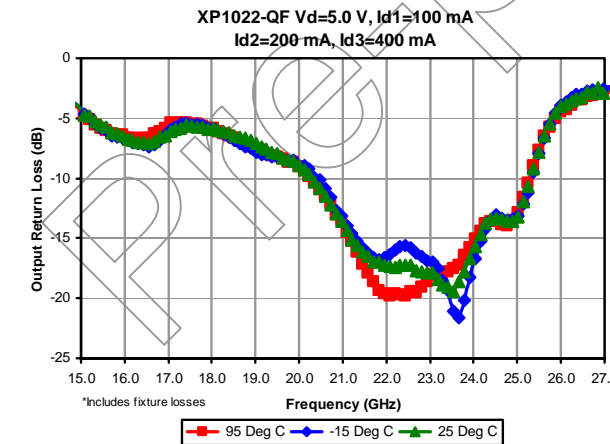
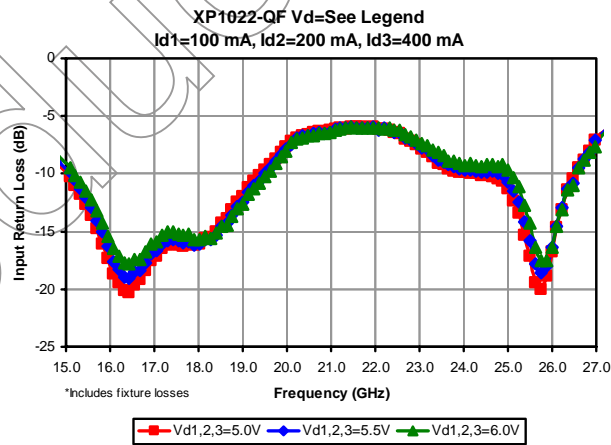
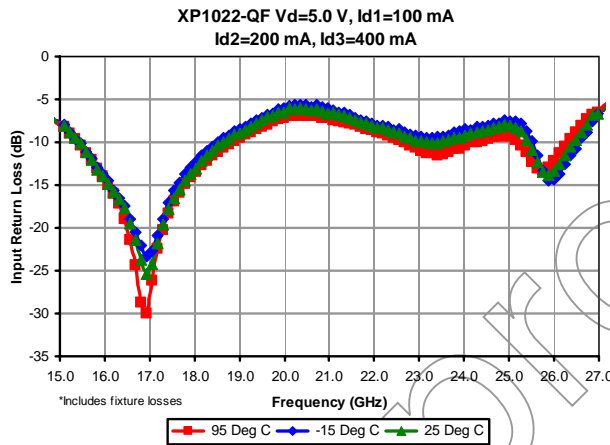
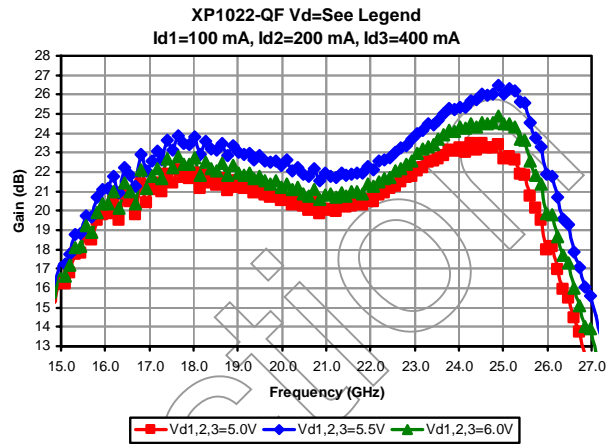
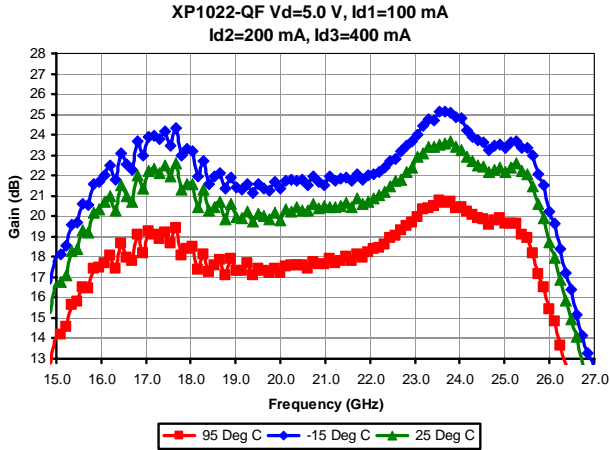

# 17.0-25.0 GHz GaAs MMIC Power Amplifier, QFN

November 2006 - Rev 15-Nov-06

PI022-QF  
RoHS

## Power Amplifier Measurements (cont.)

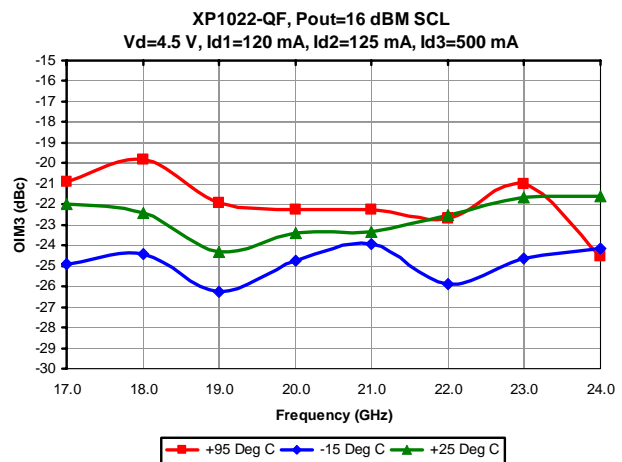
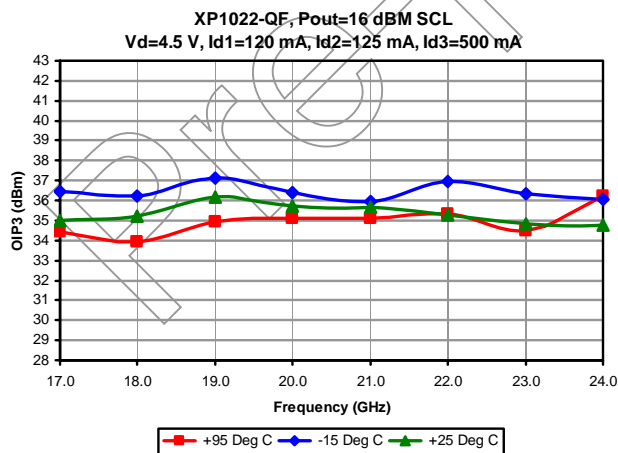
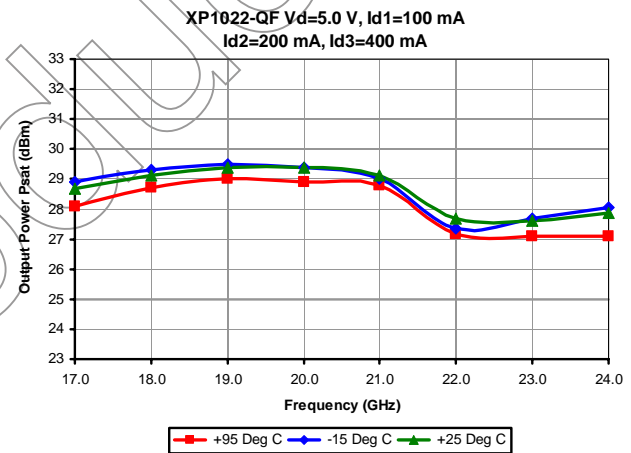
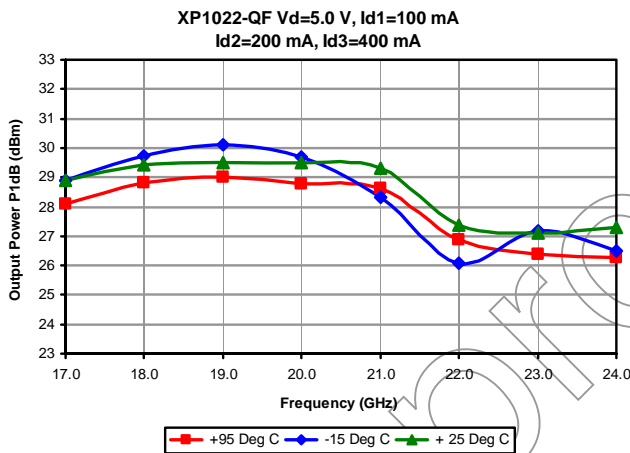
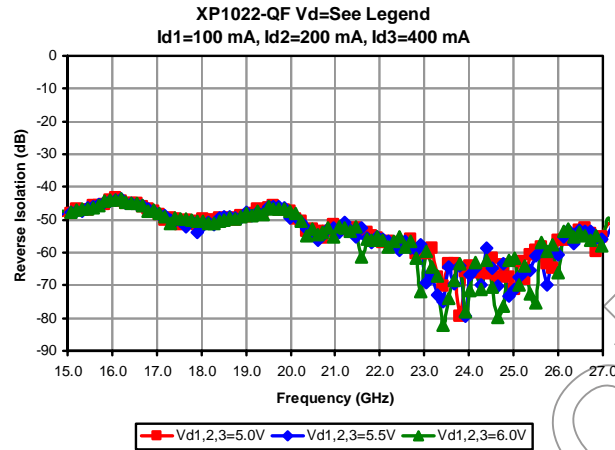

# 17.0-25.0 GHz GaAs MMIC Power Amplifier, QFN

November 2006 - Rev 15-Nov-06

PI022-QF  
RoHS

## Package Dimensions/Layout QF

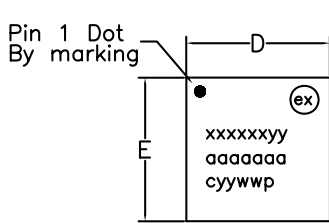

TOP VIEW

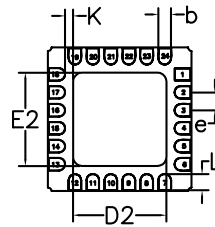
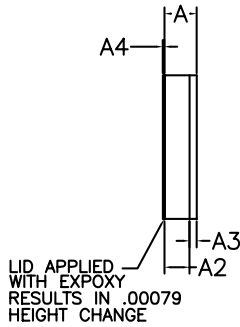

BOTTOM VIEW

Pin	Description
3	Ground
4	RF Input
5	Ground
7	Vg1
9	Vg2
10	Vg3
11	Det
12	Ref
14	Ground
15	RF Output
16	Ground
19	Vd3
21	Vd2
23	Vd1

RECOMMENDED SOLDER PAD PITCH AND DIMENSIONS

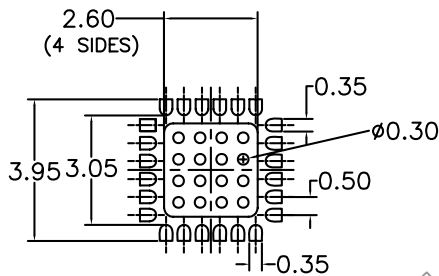

Note:

1. ALL DIMENSIONS ARE IN mm.

	MIN	TYP	MAX
A	0.55	0.60	.65
A2	0.00	0.40	.45
A3	0.20 REF		
A4	.010		
b	0.25	0.30	0.35
K	0.23	-	-
D	4.00 BSC		
E	4.00 BSC		
e	0.50		
D2	2.50	2.60	2.70
E2	2.50	2.60	2.70
L	0.40	0.45	0.50

## Functional Block Diagram/Board Layout

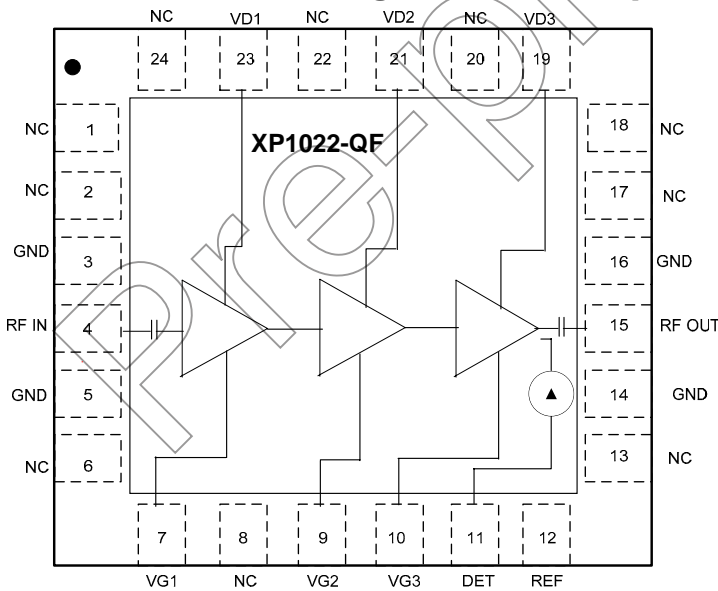

Bypass Capacitors - See App Note [2]

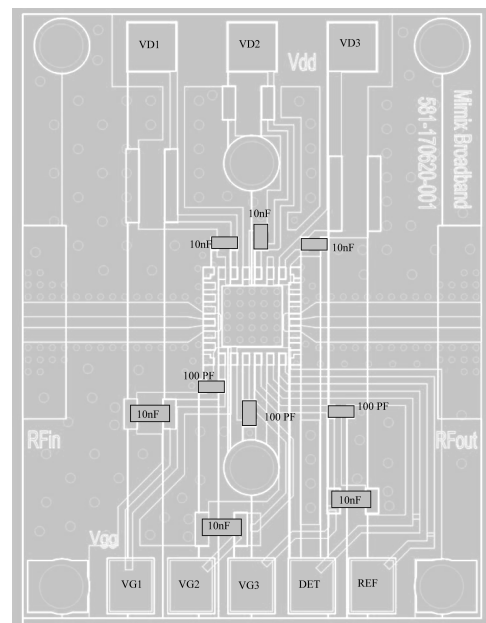

# 17.0-25.0 GHz GaAs MMIC Power Amplifier, QFN

**App Note [1] Biasing** - It is recommended to separately bias each amplifier stage Vd1 through Vd3 at Vd(1,2,3)=5.0V with Id1=100mA, Id2=200mA and Id3=400mA. Separate biasing is recommended if the amplifier is to be used at high levels of saturation, where gate rectification will alter the effective gate control voltage. For non-critical applications it is possible to parallel all stages and adjust the common gate voltage for a total drain current Id(total)=700 mA. It is also recommended to use active biasing to keep the currents constant as the RF power and temperature vary; this gives the most reproducible results. Depending on the supply voltage available and the power dissipation constraints, the bias circuit may be a single transistor or a low power operational amplifier, with a low value resistor in series with the drain supply used to sense the current. The gate of the pHEMT is controlled to maintain correct drain current and thus drain voltage. The typical gate voltage needed to do this is -0.7V. Typically the gate is protected with Silicon diodes to limit the applied voltage. Also, make sure to sequence the applied voltage to ensure negative gate bias is available before applying the positive drain supply.

**App Note [2] Bias Arrangement -**

For Parallel Stage Bias (Recommended for general applications) -- The same as Individual Stage Bias but all the drain or gate pad DC bypass capacitors (~100-200 pF) can be combined. Additional DC bypass capacitance (~0.01 uF) is also recommended to all DC or combination (if gate or drains are tied together) of DC bias pads.

**For Individual Stage Bias (Recommended for saturated applications)** - Each DC pad (Vd1,2,3 and Vg1,2,3) needs to have DC bypass capacitance (~100-200 pF) as close to the device as possible. Additional DC bypass capacitance (~0.01 uF) is also recommended.

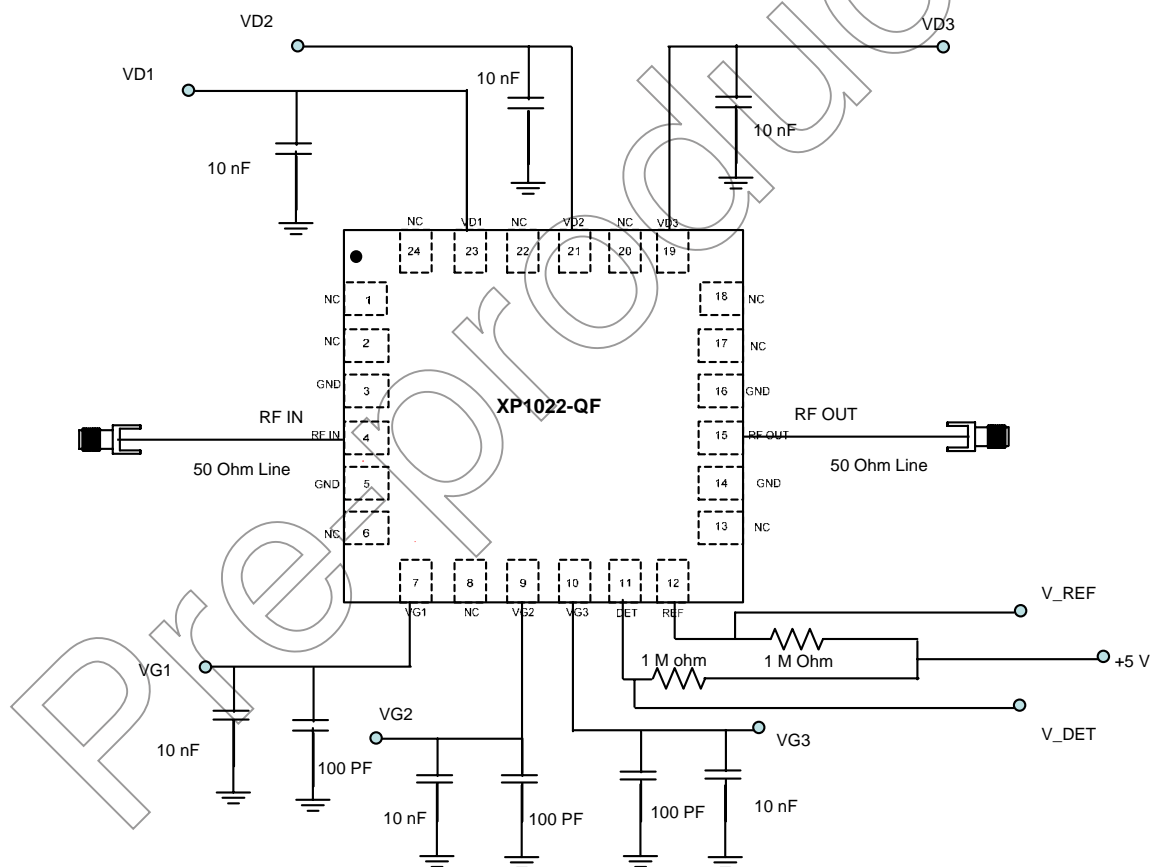

# 17.0-25.0 GHz GaAs MMIC Power Amplifier, QFN

November 2006 - Rev 15-Nov-06

PI022-QF  
RoHS

**App Note [3] On Board Detector** – The output signal of the power amplifier is coupled via a 15 dB directional coupler to a detector, which comprises a diode connected to the signal path, and a second diode used to provide a temperature compensation signal. The common bias terminal is Vdet, and is nominally set to forward bias both diodes. The Vdet port can be connected directly to a 5V bias, and given the internal series resistance, results in about 1mA of bias current.

**App Note [4] Output Power Adjust Using Drain/Gate Control** – This device has a very useful additional feature. The output power can be adjusted by lowering the combined drain voltages and individual or combined gate voltages towards pinch off without sacrificing much in the way of Input/Output 3rd Order Intercept Point. Improvements to the IIP3/OIP3 while attenuating the gain are also possible with individual gate control. Data here has been taken using combined drain and gate control (all gates changed together) to lower the device's output power. The results are shown below. Additionally, the accompanying graph shows the typical level of attenuation achievable as the drain and gate is adjusted at various levels until pinch-off.

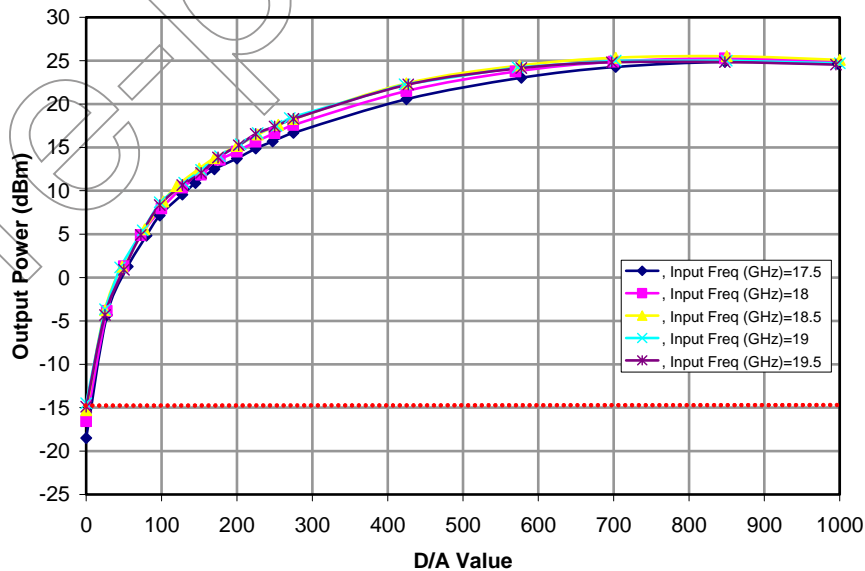
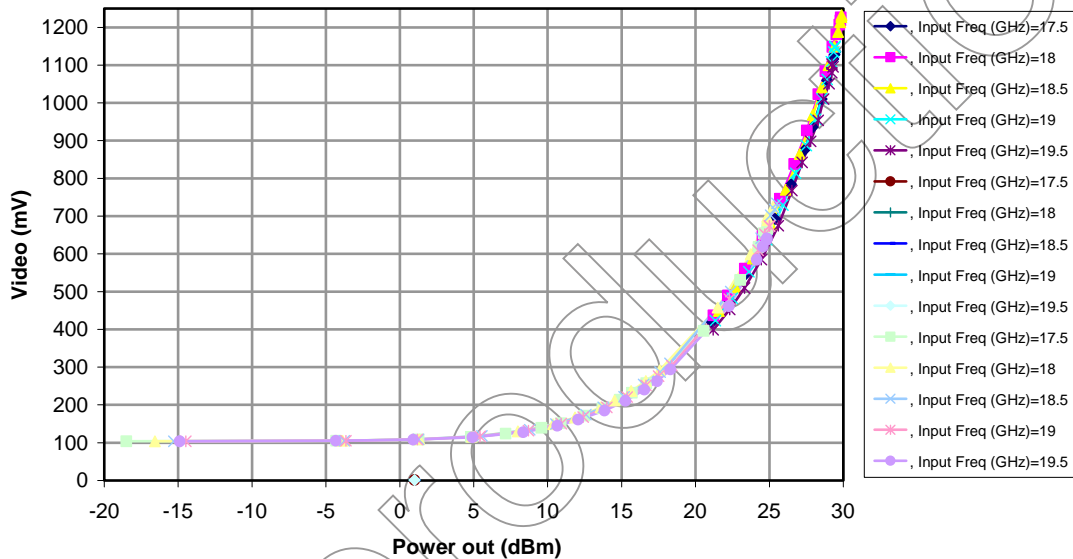

# 17.0-25.0 GHz GaAs MMIC Power Amplifier, QFN

## MTTF Tables (TBD)

These numbers were calculated based on accelerated life test information and thermal model analysis received from the fabricating foundry.

Backplate Temperature	Channel Temperature	Rth	MTTF Hours	FITs
55 deg Celsius	Deg Celsius	C/W	E+	E+
75 deg Celsius	Deg Celsius	C/W	E+	E+
95 deg Celsius	Deg Celsius	C/W	E+	E+

Bias Conditions: Vd1,2,3=5.0V, Id1=100 mA, Id2=200 mA, Id3=300mA

## Typical Application

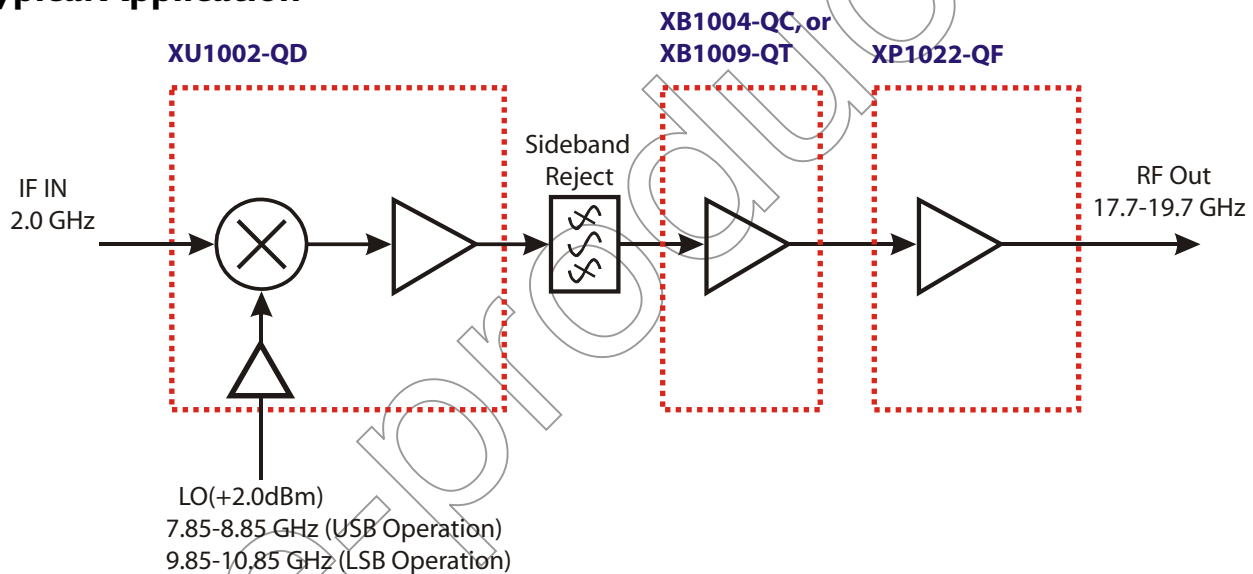

## Mimix Broadband MMIC-based 18.0-25.0 GHz Transmitter Block Diagram

(Changing-LO and IF frequencies as required allows design to operate as high as 25.0 GHz)

Mimix Broadband's 18.0-25.0 GHz XU1002 GaAs MMIC Transmitter can be used in saturated radio applications and linear modulation schemes up to 16 QAM. The transmitter can be used in upper and lower sideband applications from 18.0-25.0 GHz.



# 17.0-25.0 GHz GaAs MMIC Power Amplifier, QFN

## Handling and Assembly Information

**CAUTION!** - Mimix Broadband MMIC Products contain gallium arsenide (GaAs) which can be hazardous to the human body and the environment. For safety, observe the following procedures:

- Do not ingest.
- Do not alter the form of this product into a gas, powder, or liquid through burning, crushing, or chemical processing as these by-products are dangerous to the human body if inhaled, ingested, or swallowed.
- Observe government laws and company regulations when discarding this product. This product must be discarded in accordance with methods specified by applicable hazardous waste procedures.

**Life Support Policy** - Mimix Broadband's products are not authorized for use as critical components in life support devices or systems without the express written approval of the President and General Counsel of Mimix Broadband. As used herein: (1) Life support devices or systems are devices or systems which, (a) are intended for surgical implant into the body, or (b) support or sustain life, and whose failure to perform when properly used in accordance with instructions for use provided in the labeling, can be reasonably expected to result in a significant injury to the user. (2) A critical component is any component of a life support device or system whose failure to perform can be reasonably expected to cause the failure of the life support device or system, or to affect its safety or effectiveness.

**Package Attachment** - This packaged product from Mimix Broadband is provided as a rugged surface mount package compatible with high volume solder installation. Vacuum tools or other suitable pick and place equipment may be used to pick and place this part. Care should be taken to ensure that there are no voids or gaps in the solder connection so that good RF, DC and ground connections are maintained. Voids or gaps can eventually lead not only to RF performance degradation, but reduced reliability and life of the product due to thermal stress.

### Typical Reflow Profiles

Reflow Profile	SnPb	Pb Free
Ramp Up Rate	3-4 °C/sec	3-4 °C/sec
Activation Time and Temperature	60-120 sec @ 140-160 °C	60-180 sec @ 170-200 °C
Time Above Melting Point	60-150 sec	60-150 sec
Max Peak Temperature	240 °C	265 °C
Time Within 5 °C of Peak	10-20 sec	10-20 sec
Ramp Down Rate	4-6 °C/sec	4-6 °C/sec

### Factory Automation and Identification

Mimix Designator	Package Type	Number of leads offered	W Tape Width	P <sub>1</sub> Component Pitch	P <sub>0</sub> Hole Pitch	Reel Diameter	Units per Reel
-QF	QFN (4x4mm)	24	12mm	8mm	4mm	329mm (13in)	2000

Component Orientation: Parts are to be oriented with the PIN 1 closest to the tape's round sprocket holes on the tape's trailing edge.

Note: Tape and Reel packaging is ordered with a -000T suffix. Package is available in 500 unit reels through designated sales channels. Minimum order quantities should be discussed with your local sales representative.

**Mimix Lead-Free RoHS Compliant Program** - Mimix has an active program in place to meet customer and governmental requirements for eliminating lead (Pb) and other environmentally hazardous materials from our products. All Mimix RoHS compliant components are form, fit and functional replacements for their non-RoHS equivalents. Lead plating of our RoHS compliant parts is 100% matt tin (Sn) over copper alloy and is backwards compatible with current standard SnPb low-temperature reflow processes as well as higher temperature (260°C reflow) "Pb Free" processes.

### Part Number for Ordering

XP1022-QF-0N00  
XP1022-QF-EV1

### Description

Gold plated RoHS compliant 4x4 24L QFN surface mount package in bulk quantity  
XP1022-QF evaluation board