

5.9-9.5 GHz Linear Power Amplifier QFN, 4x4mm

Mimix
BROADBAND™

February 2010 - Rev 17-Feb-10

✕ P1035-QH
✕ RoHS

Features

- ✕ 26 dB Small Signal Gain
- ✕ 39 dBm Third Order Intercept Point (OIP3)
- ✕ Integrated Power Detector
- ✕ 4x4mm QFN Package, RoHS Compliant
- ✕ 100% RF Testing



General Description

The XP1035-QH is a packaged linear power amplifier that operates over the 5.9-9.5 GHz frequency band. The device provides 26 dB gain and 39 dBm Output Third Order Intercept Point (OIP3) across the band and is offered in an industry standard, fully molded 4x4mm QFN package. The packaged amplifier is comprised of a three stage power amplifier with an integrated, temperature compensated on-chip power detector. The device includes on-chip ESD protection structures and DC by-pass capacitors to ease the implementation and volume assembly of the packaged part. The device is manufactured in GaAs PHEMT device technology with BCB wafer coating to enhance ruggedness and repeatability of performance. The XP1035-QH is well suited for Point-to-Point Radio, LMDS, SATCOM and VSAT applications.

Absolute Maximum Ratings¹

| | |
|--|----------------|
| Supply Voltage (Vd1,2,3) | +7.2V |
| Supply Current (Id1,2,3) | 600 mA |
| Gate Bias Voltage (Vg1,2,3) | -3V |
| Max Power Dissipation (Pdis) | 4.2W |
| RF Input Power | +15 dBm |
| Operating Temperature (Ta) | -55 to +85 °C |
| Storage Temperature (Tstg) | -65 to +165 °C |
| Channel Temperature (Tch) ² | 150 °C |
| MSL Level (MSL) | MSL3 |

(1) Operation of this device above any one of these parameters may cause permanent damage.

(2) Channel temperature directly affects a device's MTTF. Channel temperature should be kept as low as possible to maximize lifetime.

Electrical Characteristics (Ambient Temperature T = 25 °C)

| Parameter | Units | Min. | Typ. | Max. |
|----------------------------------|-------|------|------|------|
| Frequency Range (f) | GHz | 5.9 | - | 9.5 |
| Small Signal Gain (S21) | dB | | 26 | |
| Input Return Loss (S11) | dB | | 13 | |
| Output Return Loss (S22) | dB | | 10 | |
| Reverse Isolation (S12) | dB | | 45 | |
| Psat | dBm | | 29 | |
| P1dB | dBm | | 27.5 | |
| OIP3 | dBm | | 39 | |
| Drain Bias Voltage (Vd1,2,3) | VDC | | 6 | |
| Detector Bias Voltage (Vdet,ref) | VDC | | 5 | |
| Gate Bias Voltage (Vg1,2,3) | VDC | -2 | -1 | |
| Supply Current (Id1) | mA | | 70 | |
| Supply Current (Id2) | mA | | 140 | |
| Supply Current (Id3) | mA | | 280 | |

Mimix Broadband, Inc., 10795 Rockley Rd., Houston, Texas 77099
Tel: 281.988.4600 Fax: 281.988.4615 mimixbroadband.com

Page 1 of 7

Characteristic Data and Specifications are subject to change without notice. ©2010 Mimix Broadband, Inc.
Export of this item may require appropriate export licensing from the U.S. Government. In purchasing these parts, U.S. Domestic customers accept their obligation to be compliant with U.S. Export Laws.

5.9-9.5 GHz Linear Power Amplifier QFN, 4x4mm

Power Amplifier Measurements

XP1035-QH: S11 (dB) at Vd=6V, Id=500mA

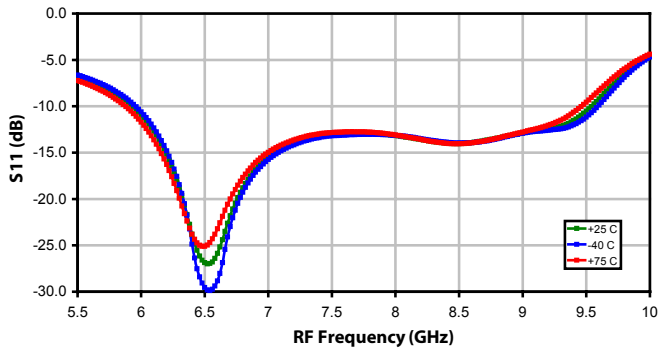

XP1035-QH: S21 (dB) at Vd=6V, Id=500mA

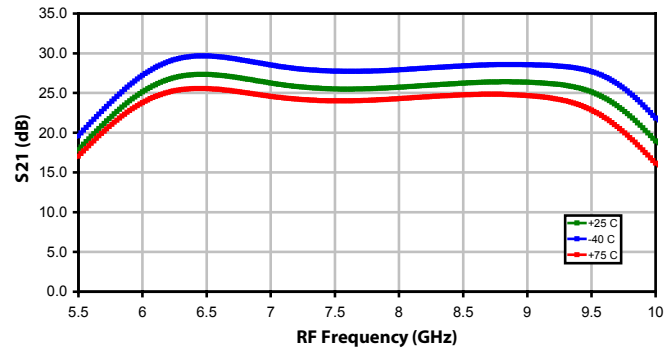

XP1035-QH: S22 (dB) at Vd=6V, Id=500mA

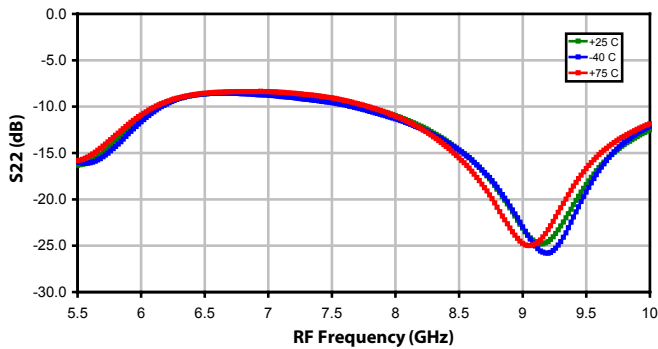

XP1035-QH: S12 (dB) at Vd=6V, Id=500mA

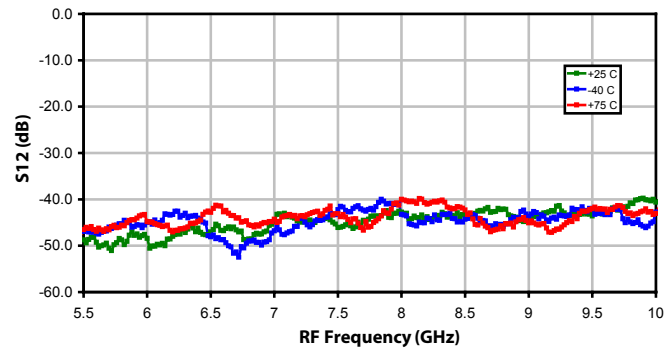

XP1035-QH: OIP3 (dBm) at Vd=6V, Id=500mA

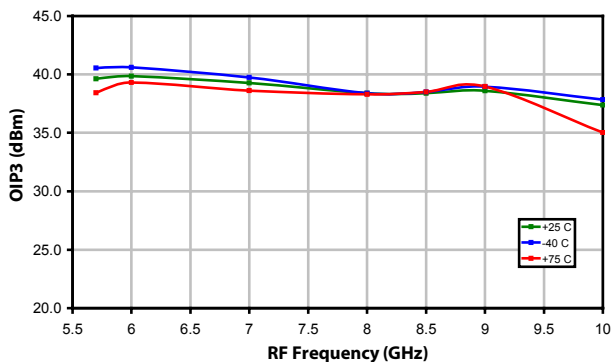

XP1035-QH: Psat (dBm) at Id=500mA, Vd=6V

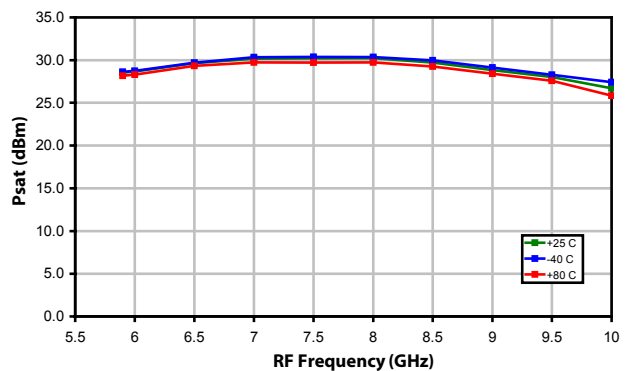

5.9-9.5 GHz Linear Power Amplifier QFN, 4x4mm

Power Amplifier Measurements (cont.)

XP1035-QH: Pout (dBm) and Gain (dB) vs Pin (dBm)
Id=500mA, Vd=6V, +25 C

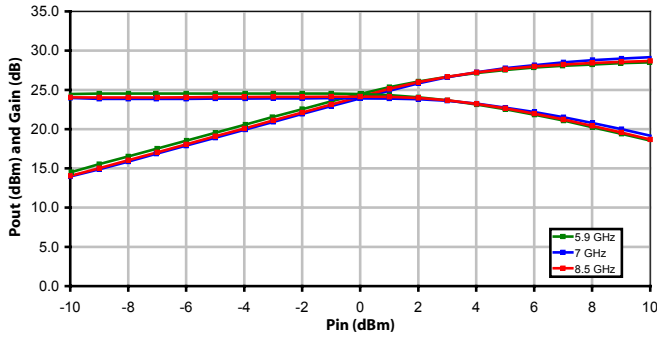

XP1035-QH: C/I3 vs Pout at Id=500mA, Vd=6V, +25 C, 10 MHz Span

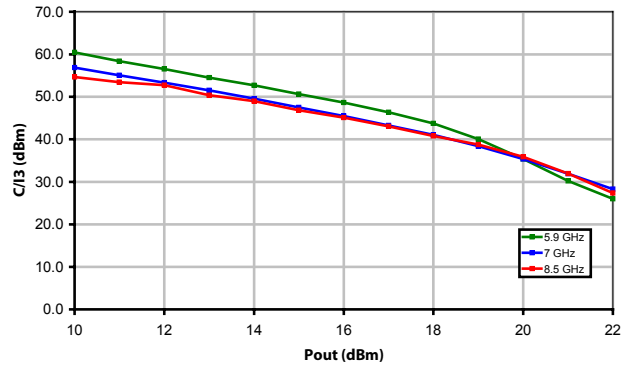

XP1035-QH: P1dB (dBm) at Id=500mA, Vd=6V

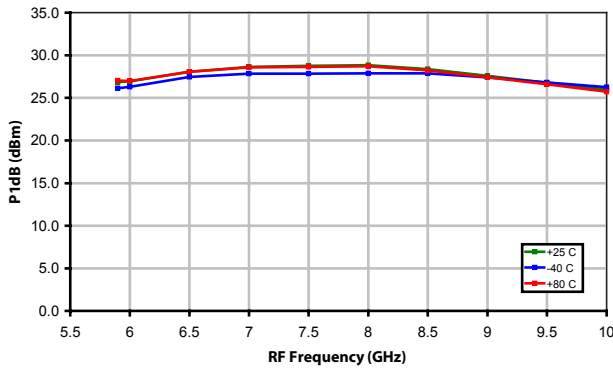

XP1035-QH: Detector (mV) vs Pout (dBm) at Id=500mA, Vd=6V, +25 C

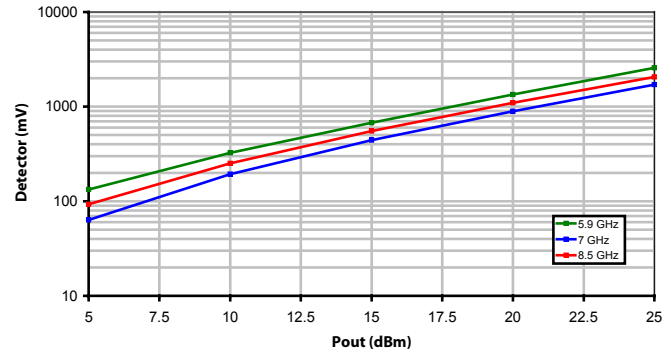

XP1035-QH:
Detector (mV) vs Pout (dBm) at Id=500mA, Vd=6V, -40 C

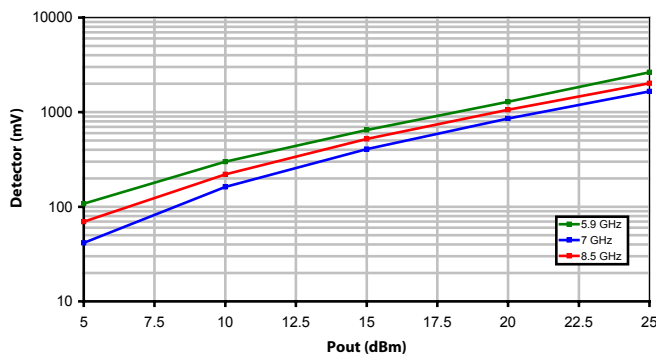

XP1035-QH:
Detector (mV) vs Pout (dBm) at Id=500mA, Vd=6V, +80 C

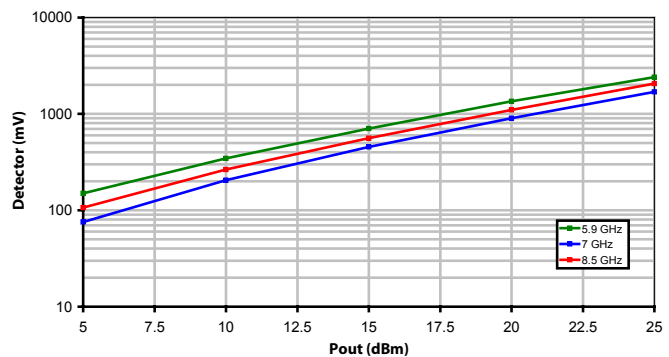

5.9-9.5 GHz Linear Power Amplifier QFN, 4x4mm

February 2010 - Rev 17-Feb-10

PI035-QH
RoHS

Package Dimensions / Layout

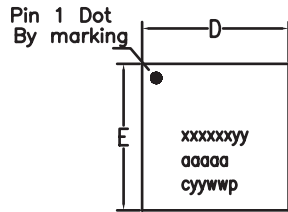

TOP VIEW

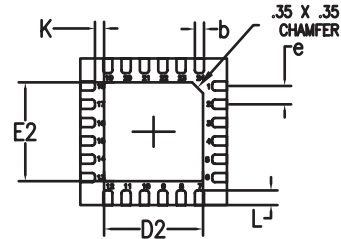
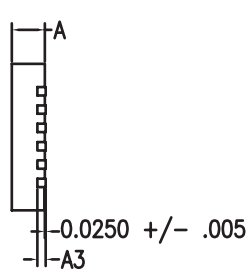

BOTTOM VIEW

MARKINGS:
PIN 1/BOM REV/Pb FREE SYM
MIMIX PART/MODEL NO.
WAFER LOT NUMBER
DATE CODE

NOTES:

1. DIMENSIONS ARE IN MM.

RECOMMENDED SOLDER PAD PITCH AND DIMENSIONS

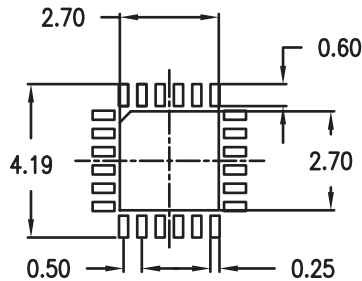

| | MIN | TYP | MAX |
|----|----------|------|------|
| A | 0.80 | 0.90 | 1.00 |
| A3 | 0.20 REF | | |
| b | 0.20 | 0.25 | 0.30 |
| K | 0.20 | - | - |
| D | 4.00 BSC | | |
| E | 4.00 BSC | | |
| e | 0.50 | | |
| D2 | 2.45 | 2.60 | 2.75 |
| E2 | 2.45 | 2.60 | 2.75 |
| L | 0.20 | 0.30 | 0.40 |

1. VIEWS ARE NOT TO SCALE: USE DIMENSIONS AND TABLE.

Functional Schematic

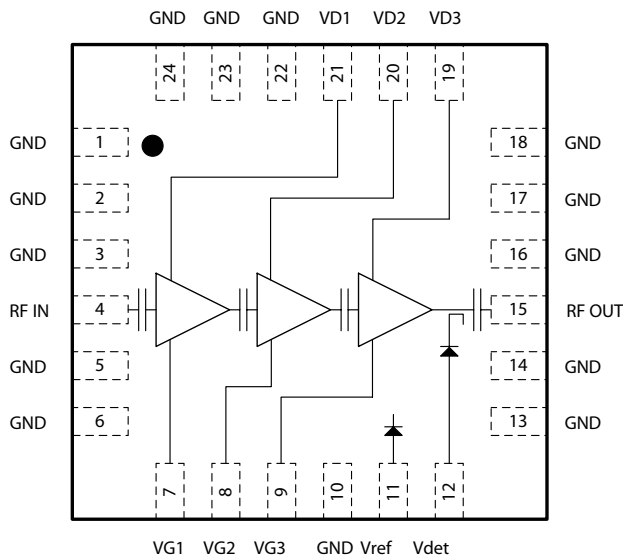

Pin Designations

| Pin Number | Pin Name | Pin Function | Nominal Value |
|------------|----------|-------------------|---------------|
| 1-3 | GND | Ground | |
| 4 | RF In | RF Input | |
| 5-6 | GND | Ground | |
| 7 | VG1 | Gate 1 Bias | ~-1.0V |
| 8 | VG2 | Gate 2 Bias | ~-1.0V |
| 9 | VG3 | Gate 3 Bias | ~-1.0V |
| 10 | GND | Ground | |
| 11 | Vref | Pwr Det Reference | 5.0V |
| 12 | Vdet | Pwr Det | 5.0V |
| 13-14 | GND | Ground | |
| 15 | RF Out | RF Output | |
| 16-18 | GND | Ground | |
| 19 | VD3 | Drain 3 Bias | 6.0V, 280 mA |
| 20 | VD2 | Drain 2 Bias | 6.0V, 140 mA |
| 21 | VD1 | Drain 1 Bias | 6.0V, 70 mA |
| 22-24 | GND | Ground | |

5.9-9.5 GHz Linear Power Amplifier QFN, 4x4mm

App Note [1] Biasing - As shown in the Pin Designations table, the device is operated by biasing VD1,2,3 at 5.0V with 70, 140, 280mA respectively. It is recommended to use active bias to keep the currents constant in order to maintain the best performance over temperature. Depending on the supply voltage available and the power dissipation constraints, the bias circuit may be a single transistor or a low power operational amplifier, with a low value resistor in series with the drain supply used to sense the current. The gate of the pHEMT is controlled to maintain correct drain current and thus drain voltage. The typical gate voltage needed to do this is -1.0V. Make sure to sequence the applied voltage to ensure negative gate bias is available before applying the positive drain supply.

App Note [2] Board Layout - As shown in the board layout, it is recommended to provide 100pF decoupling caps as close to the bias pins as possible, with additional 10µF decoupling caps.

MTTF Graphs

XP1035-QH-0G00: MTTF (hours) vs. Package Base Temperature
Vdd = 6.0 V, Idd = 500 mA

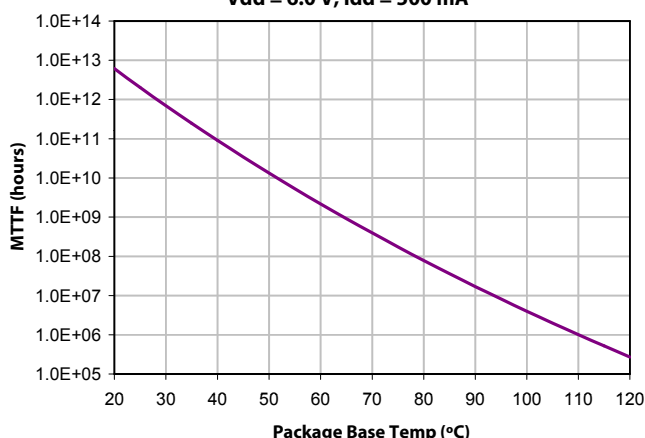

XP1035-QH-0G00: MTTF (hours) vs. Package Base Temperature
Vdd = 6.0 V, Idd = 500 mA

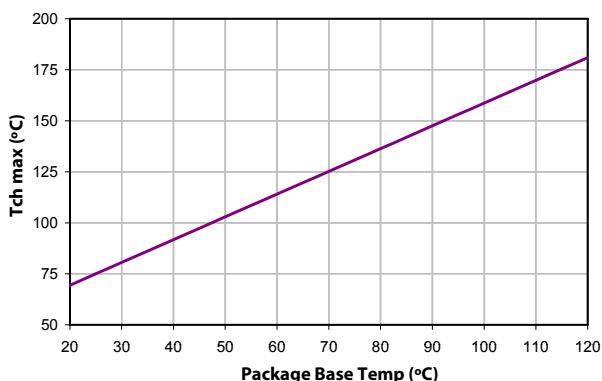

XP1035-QH-0G00: Rth vs. Package Base Temperature
Vdd = 6.0 V, Idd = 500 mA

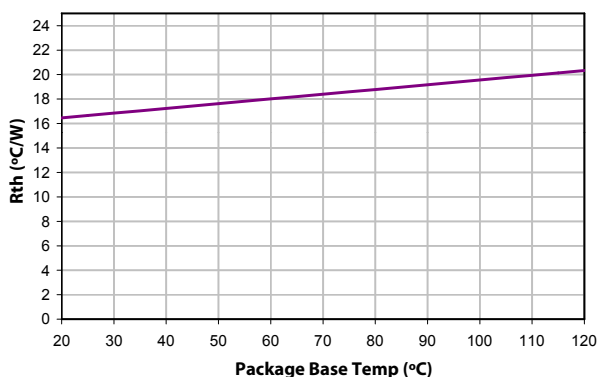

5.9-9.5 GHz Linear Power Amplifier QFN, 4x4mm

February 2010 - Rev 17-Feb-10

Mimix
BROADBAND™

PI035-QH
RoHS

Recommended Layout

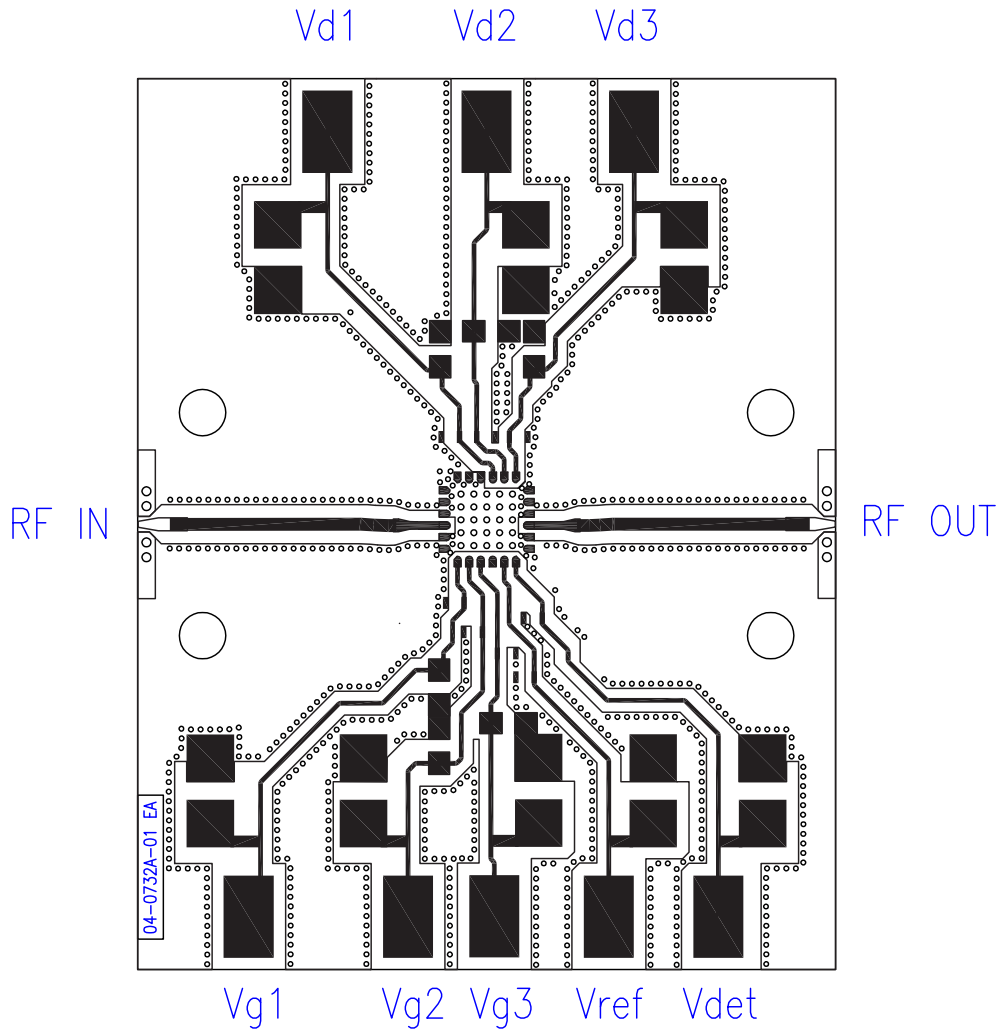

Recommended Decoupling Capacitors: 100pF 0402, 10 μ F 0805

5.9-9.5 GHz Linear Power Amplifier QFN, 4x4mm

February 2010 - Rev 17-Feb-10

Handling and Assembly Information

CAUTION! - Mimix Broadband MMIC Products contain gallium arsenide (GaAs) which can be hazardous to the human body and the environment. For safety, observe the following procedures:

- Do not ingest.
- Do not alter the form of this product into a gas, powder, or liquid through burning, crushing, or chemical processing as these by-products are dangerous to the human body if inhaled, ingested, or swallowed.
- Observe government laws and company regulations when discarding this product. This product must be discarded in accordance with methods specified by applicable hazardous waste procedures.

Electrostatic Sensitive Device -

Observe all necessary precautions when handling.

Life Support Policy - Mimix Broadband's products are not authorized for use as critical components in life support devices or systems without the express written approval of the President and General Counsel of Mimix Broadband. As used herein: (1) Life support devices or systems are devices or systems which, (a) are intended for surgical implant into the body, or (b) support or sustain life, and whose failure to perform when properly used in accordance with instructions for use provided in the labeling, can be reasonably expected to result in a significant injury to the user. (2) A critical component is any component of a life support device or system whose failure to perform can be reasonably expected to cause the failure of the life support device or system, or to affect its safety or effectiveness.

Package Attachment - This packaged product from Mimix Broadband is provided as a rugged surface mount package compatible with high volume solder installation. Vacuum tools or other suitable pick and place equipment may be used to pick and place this part. Care should be taken to ensure that there are no voids or gaps in the solder connection so that good RF, DC and ground connections are maintained. Voids or gaps can eventually lead not only to RF performance degradation, but reduced reliability and life of the product due to thermal stress.

Typical Reflow Profiles

| Reflow Profile | SnPb | Pb Free |
|---------------------------------|-------------------------|-------------------------|
| Ramp Up Rate | 3-4 °C/sec | 3-4 °C/sec |
| Activation Time and Temperature | 60-120 sec @ 140-160 °C | 60-180 sec @ 170-200 °C |
| Time Above Melting Point | 60-150 sec | 60-150 sec |
| Max Peak Temperature | 240 °C | 265 °C |
| Time Within 5 °C of Peak | 10-20 sec | 10-20 sec |
| Ramp Down Rate | 4-6 °C/sec | 4-6 °C/sec |

Mimix Lead-Free RoHS Compliant Program - Mimix has an active program in place to meet customer and governmental requirements for eliminating lead (Pb) and other environmentally hazardous materials from our products. All Mimix RoHS compliant components are form, fit and functional replacements for their non-RoHS equivalents. Lead plating of our RoHS compliant parts is 100% matte tin (Sn) over copper alloy and is backwards compatible with current standard SnPb low-temperature reflow processes as well as higher temperature (260°C reflow) "Pb Free" processes.

Part Number for Ordering

XP1035-QH-0G00
XP1035-QH-0G0T
XP1035-QH-EV1

Description

Matte Tin plated RoHS compliant 4x4 24L QFN surface mount package in bulk quantity
Matte Tin plated RoHS compliant 4x4 24L QFN surface mount package in tape and reel
XP1035-QH evaluation board



Caution: ESD Sensitive
Appropriate precautions in handling, packaging
and testing devices must be observed.

Proper ESD procedures should be followed when handling this device.

Mimix Broadband, Inc., 10795 Rockley Rd., Houston, Texas 77099
Tel: 281.988.4600 Fax: 281.988.4615 mimixbroadband.com

Page 7 of 7