

# 6.4-7.4 GHz GaAs MMIC Voltage Controlled Oscillator

April 2007 - Rev 17-Apr-07

## Features

- ✕ On-Chip Resonator
- ✕ +5.0 dBm Output Power
- ✕ -97 dBc/Hz @ 100KHz Phase Noise
- ✕ 20mA @ -5.0V Bias Supply
- ✕ 100% On-Wafer, DC and Output Power Testing
- ✕ 100% Visual Inspection to MIL-STD-883 Method 2010

## General Description

Mimix Broadband's 6.4-7.4 GHz GaAs HBT VCO is a fully integrated oscillator MMIC with on-chip tuning diode and resonator. This design is based on a cross coupled differential pair with on-chip buffer amplifier and output balun. The use of a high-Q resonator structure and integrated varactor diodes results in optimum phase-noise performance. This MMIC uses Mimix Broadband's 2 um GaAs HBT device model technology to ensure low flicker (1/f) noise and high reliability. The chip has surface passivation to protect and provide a rugged part with backside via holes and gold metallization to allow either a conductive epoxy or eutectic solder die attach process. This device is well suited for Millimeter-wave Point-to-Point Radio, LMDS, SATCOM and VSAT applications.

## Chip Device Layout

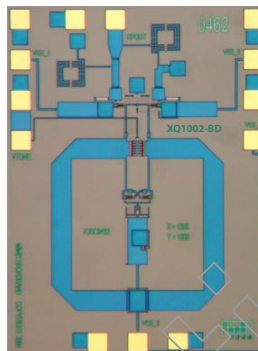

## Absolute Maximum Ratings

Supply Voltage (Vee1,2,3)	-6.0 VDC
Supply Voltage (Vtune)	+6.0 VDC
Supply Current (Iee1,2,3)	30 mA
Supply Current (Itune)	1 mA
Storage Temperature (Tstg)	-65 to +165 °C
Operating Temperature (Ta)	-55 to MTTF Table <sup>1</sup>
Junction Temperature (Tjtn)	MTTF Table <sup>1</sup>

(1) Junction temperature affects a device's MTTF. It is recommended to keep channel temperature as low as possible for maximum life.

## Electrical Characteristics (Ambient Temperature T = 25 °C)

Parameter	Units	Min.	Typ.	Max.
Frequency Range (f)	GHz	6.4	-	7.4
Fundamental Output Power (Pout)	dBm	-	+5.0	-
SSB Phase Noise @ 100 kHz Offset	dBc/Hz	-	-97.0	-
SSB Phase Noise @ 1 MHz Offset	dBc/Hz	-	-118.0	-
2nd Harmonic Suppression	dBc	-	-17.0	-
3rd Harmonic Suppression	dBc	-	-27.0	-
4th Harmonic Suppression	dBc	-	-37.0	-
Frequency Pushing (Vee)	MHz/Volt	-	60.0	-
Supply Voltage (Vee)	VDC	-	-5.0	-
Frequency Tuning Voltage (Vtune)	VDC	+0.0	-	+6.0
Supply Current (Iee) (Vee=-5.0V Typical)	mA	-	20	25

# 6.4-7.4 GHz GaAs MMIC Voltage Controlled Oscillator

April 2007 - Rev 17-Apr-07

XQ1002-BD

## Oscillator Measurements

XQ1002-BD Output Frequency vs. Tuning Voltage

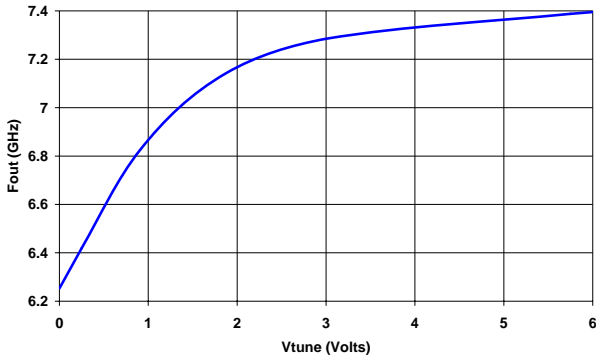

XQ1002-BD Kvco vs. Tuning Voltage

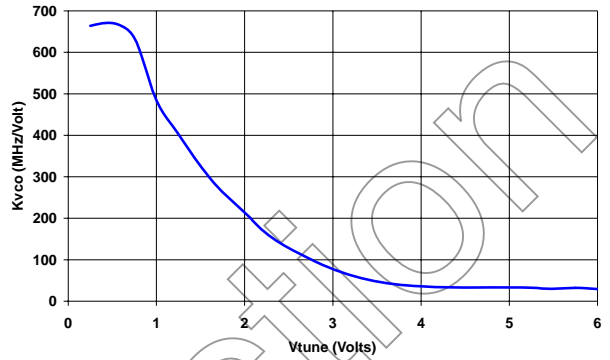

XQ1002-BD Output Power vs. Tuning Voltage

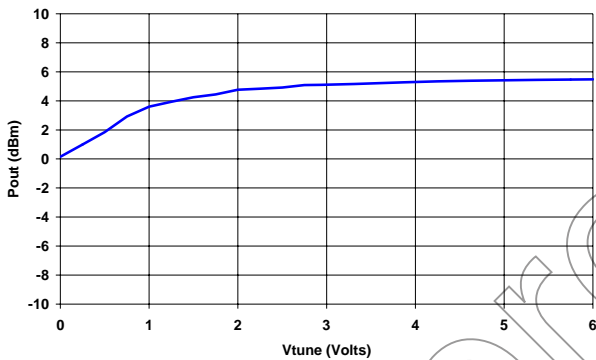

XQ1002-BD Harmonic Levels vs. Tuning Voltage

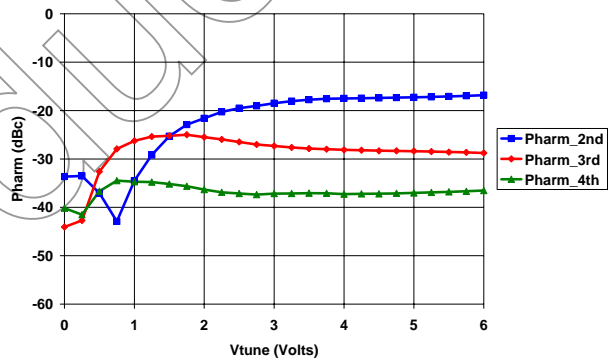



# 6.4-7.4 GHz GaAs MMIC Voltage Controlled Oscillator

April 2007 - Rev 17-Apr-07

**App Note [1] Biasing** - As shown in the bonding diagram, this device is operated by separately biasing Vee1, Vee2, Vee3 and Vtune with Vee1 = Vee2 = Vee3 = -5.0 V and Vtune = 0.0 to 6.0 V, Iee1 = Iee2 = Iee3 = ~ 6.5 mA.

**App Note [2] Bias Arrangement** - Each DC pad (Vee1, 2, 3 and Vtune) needs to have DC bypass capacitance. (~100 - 200 pF, 100pF max on Vtune) as close to the device as possible. The Vee3 pads have been tied together on chip and can be biased from either location.

## MTTF Table

These numbers were calculated based on accelerated life test information and thermal model analysis received from the fabricating foundry.

Backplate Temperature	MTTF Hours	FITs
55 deg Celsius	4.99E+09	2.00E-01
75 deg Celsius	3.47E+08	2.88E+00
95 deg Celsius	3.31E+07	3.02E+01

## Functional Diagram & Vtune Equivalent Input Circuit

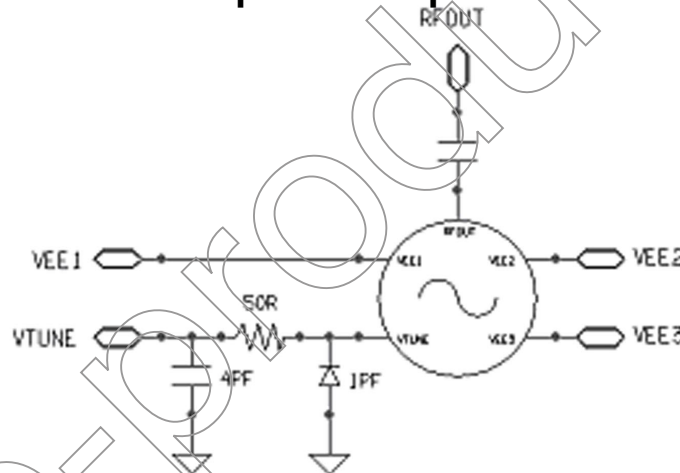

## Typical Application

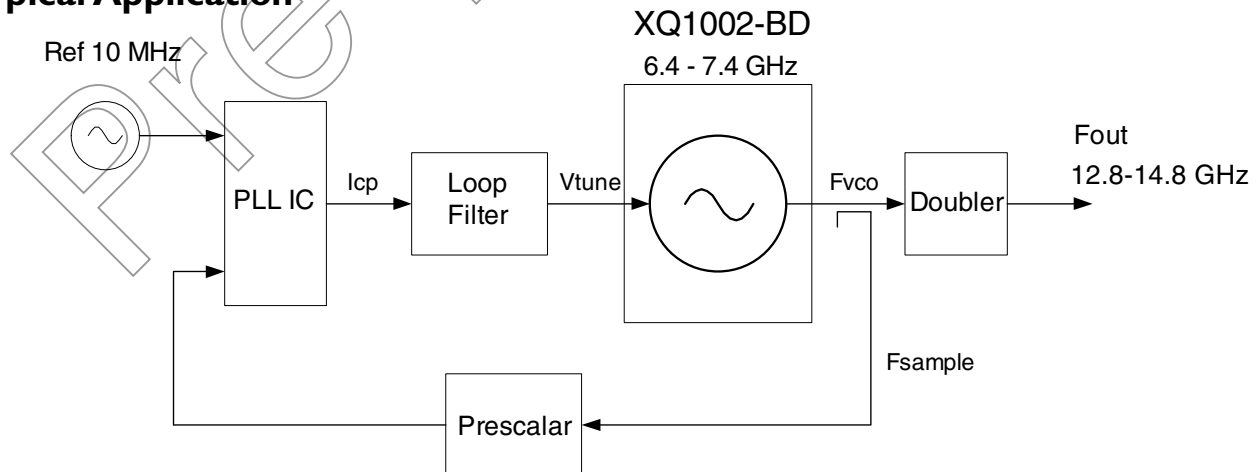

# 6.4-7.4 GHz GaAs MMIC Voltage Controlled Oscillator

April 2007 - Rev 17-Apr-07

## Handling and Assembly Information

**CAUTION!** - Mimix Broadband MMIC Products contain gallium arsenide (GaAs) which can be hazardous to the human body and the environment. For safety, observe the following procedures:

- Do not ingest.
- Do not alter the form of this product into a gas, powder, or liquid through burning, crushing, or chemical processing as these by-products are dangerous to the human body if inhaled, ingested, or swallowed.
- Observe government laws and company regulations when discarding this product. This product must be discarded in accordance with methods specified by applicable hazardous waste procedures.

**Life Support Policy** - Mimix Broadband's products are not authorized for use as critical components in life support devices or systems without the express written approval of the President and General Counsel of Mimix Broadband. As used herein: (1) Life support devices or systems are devices or systems which, (a) are intended for surgical implant into the body, or (b) support or sustain life, and whose failure to perform when properly used in accordance with instructions for use provided in the labeling, can be reasonably expected to result in a significant injury to the user. (2) A critical component is any component of a life support device or system whose failure to perform can be reasonably expected to cause the failure of the life support device or system, or to affect its safety or effectiveness.

**ESD** - Gallium Arsenide (GaAs) devices are susceptible to electrostatic and mechanical damage. Die are supplied in antistatic containers, which should be opened in cleanroom conditions at an appropriately grounded anti-static workstation. Devices need careful handling using correctly designed collets, vacuum pickups or, with care, sharp tweezers.

**Die Attachment** - GaAs Products from Mimix Broadband are 0.100 mm (0.004") thick and have vias through to the backside to enable grounding to the circuit. Microstrip substrates should be brought as close to the die as possible. The mounting surface should be clean and flat. If using conductive epoxy, recommended epoxies are Tanaka TS3332LD, Die Mat DM6030HK or DM6030HK-Pt cured in a nitrogen atmosphere per manufacturer's cure schedule. Apply epoxy sparingly to avoid getting any on to the top surface of the die. An epoxy fillet should be visible around the total die periphery. For additional information please see the Mimix "Epoxy Specifications for Bare Die" application note. If eutectic mounting is preferred, then a fluxless gold-tin (AuSn) preform, approximately 0.001" thick, placed between the die and the attachment surface should be used. A die bonder that utilizes a heated collet and provides scrubbing action to ensure total wetting to prevent void formation in a nitrogen atmosphere is recommended. The gold-tin eutectic (80% Au 20% Sn) has a melting point of approximately 280 °C (Note: Gold Germanium should be avoided). The work station temperature should be 310 °C +/- 10 °C. Exposure to these extreme temperatures should be kept to minimum. The collet should be heated, and the die pre-heated to avoid excessive thermal shock. Avoidance of air bridges and force impact are critical during placement.

**Wire Bonding** - Windows in the surface passivation above the bond pads are provided to allow wire bonding to the die's gold bond pads. The recommended wire bonding procedure uses 0.076 mm x 0.013 mm (0.003" x 0.0005") 99.99% pure gold ribbon with 0.5-2% elongation to minimize RF port bond inductance. Gold 0.025 mm (0.001") diameter wedge or ball bonds are acceptable for DC Bias connections. Aluminum wire should be avoided. Thermo-compression bonding is recommended though thermosonic bonding may be used providing the ultrasonic content of the bond is minimized. Bond force, time and ultrasonics are all critical parameters. Bonds should be made from the bond pads on the die to the package or substrate. All bonds should be as short as possible.

### Part Number for Ordering

XQ1002-BD-000V

XQ1002-BD-EV1

### Description

Where "V" is RoHS compliant die packed in vacuum release gel paks

XQ1002 die evaluation module