

Cree® XLamp® XQ Family LEDs

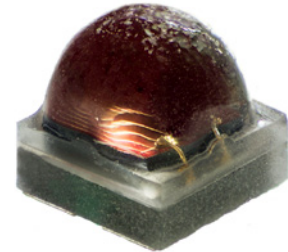
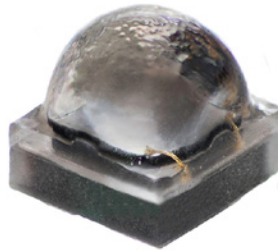

TABLE OF CONTENTS

Introduction.....	1
Bin and Order-Code Format	2
Performance Groups – Luminous Flux.....	3
Performance Groups – Forward Voltage	3
Performance Groups – Chromaticity	4
Performance Groups – Dominant Wavelength	6
Cree’s Standard White Chromaticity Regions Plotted on the 1931 CIE Curve.....	7
Cree’s Standard Cool White Kits Plotted on ANSI Standard Chromaticity Regions.....	8
Cree’s Standard Warm and Neutral White Kits Plotted on ANSI Standard Chromaticity Regions	9
Cree’s Standard Chromaticity Kits.....	10
Standard Order Codes and Bins	
XQ-B ANSI Cool White	11
XQ-B Neutral White	11
XQ-B Warm White	12
XQ-D ANSI Cool White	13
XQ-D Neutral White	14
XQ-D Warm White	15
XQ-E ANSI Cool White.....	16
XQ-E Neutral White	17
XQ-E Warm White	18
XQ-E Color	19

INTRODUCTION

This document describes the product nomenclature required to select and order Cree’s XLamp XQ Family LEDs. XLamp XQ Family LEDs are tested and sorted into bins which are then combined into orderable kits identified by an order code.

All XLamp LEDs are tested and sorted by color and brightness into a unique bin. Each bin contains LEDs from only one color and brightness group and is uniquely identified by a bin code. White XLamp LEDs are sorted by chromaticity (color) and luminous flux (brightness). Color XLamp LEDs are sorted by dominant wavelength (color) and luminous or radiant flux (brightness). LEDs are shipped on reels containing LEDs from one bin and are always labeled with the appropriate bin code.

Kits contain LEDs from a number of similar bins and are fully defined by their order codes. A full explanation of the order codes for XLamp XQ Family LEDs, as well as a list of standard order codes, is provided in this document.

BIN AND ORDER-CODE FORMAT

Bin codes and order codes for XQ LEDs are configured in the following manner:

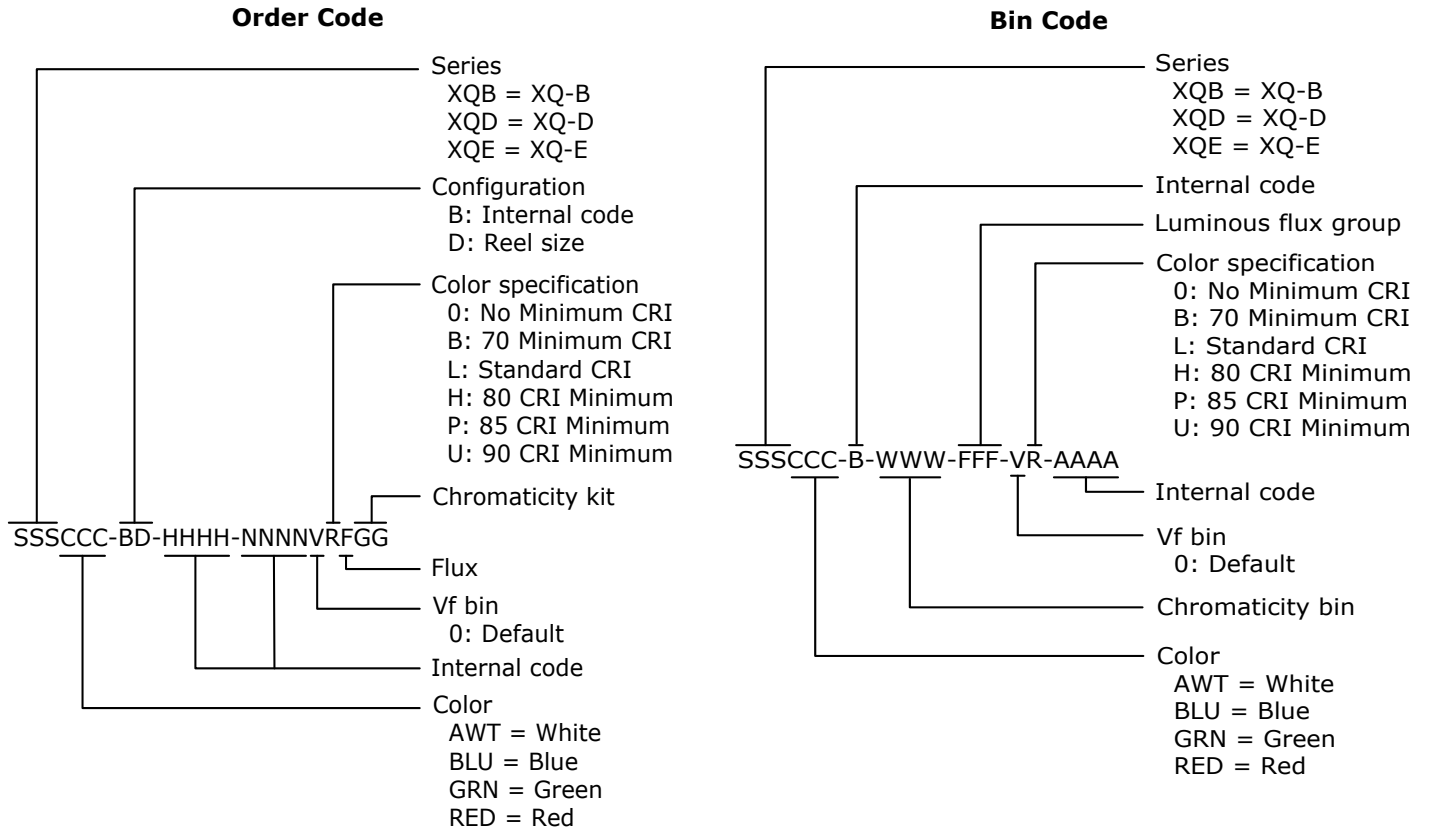

PERFORMANCE GROUPS – LUMINOUS FLUX

XLamp XQ Family White LEDs are tested for luminous flux and placed into one of the following luminous-flux groups. These group codes, with a 0 appended, are used in the Bin Code “Luminous flux group.”

Group Code	Min. Luminous Flux (lm)	Max. Luminous Flux (lm)
H0	18.1	23.5
J2	23.5	26.5
J3	26.5	30.6
K2	30.6	35.2
K3	35.2	39.8
M2	39.8	45.7
M3	45.7	51.7
N2	51.7	56.8
N3	56.8	62
N4	62	67.2
P2	67.2	73.9
P3	73.9	80.6
P4	80.6	87.4
Q2	87.4	93.9
Q3	93.9	100
Q4	100	107
Q5	107	114
R2	114	122
R3	122	130
R4	130	139
R5	139	148
S2	148	156

PERFORMANCE GROUPS – FORWARD VOLTAGE

Red XLamp LEDs are tested for forward voltage and sorted into one of the forward voltage bins defined below.

Forward Voltage Group	Min. Forward Voltage @ 350 mA	Max. Forward Voltage @ 350 mA
B	1.75	2.0
C	2.0	2.25
D	2.25	2.5
E	2.5	2.75
F	2.75	3.0
G	3.0	3.25
H	3.25	3.5
J	3.5	3.75

PERFORMANCE GROUPS – CHROMATICITY

XLamp XQ Family White LEDs are tested for luminous flux and placed into one of the following chromaticity groups. These group codes are used in the Bin Code "Chromaticity bin." Two-digit group codes are appended with a 0.

Region	x	y	Region	x	y	Region	x	y	Region	x	y
0A	0.2950	0.2970	0B	0.2920	0.3060	0C	0.2984	0.3133	0D	0.2984	0.3133
	0.2920	0.3060		0.2895	0.3135		0.2962	0.3220		0.3048	0.3207
	0.2984	0.3133		0.2962	0.3220		0.3028	0.3304		0.3068	0.3113
	0.3009	0.3042		0.2984	0.3133		0.3048	0.3207		0.3009	0.3042
0R	0.2980	0.2880	0S	0.2895	0.3135	0T	0.2962	0.3220	0U	0.3037	0.2937
	0.2950	0.2970		0.2870	0.3210		0.2937	0.3312		0.3009	0.3042
	0.3009	0.3042		0.2937	0.3312		0.3005	0.3415		0.3068	0.3113
	0.3037	0.2937		0.2962	0.3220		0.3028	0.3304		0.3093	0.2993
1A	0.3048	0.3207	1B	0.3028	0.3304	1C	0.3115	0.3391	1D	0.3130	0.3290
	0.3130	0.3290		0.3115	0.3391		0.3205	0.3481		0.3213	0.3373
	0.3144	0.3186		0.3130	0.3290		0.3213	0.3373		0.3221	0.3261
	0.3068	0.3113		0.3048	0.3207		0.3130	0.3290		0.3144	0.3186
1R	0.3068	0.3113	1S	0.3005	0.3415	1T	0.3099	0.3509	1U	0.3144	0.3186
	0.3144	0.3186		0.3099	0.3509		0.3196	0.3602		0.3221	0.3261
	0.3161	0.3059		0.3115	0.3391		0.3205	0.3481		0.3231	0.3120
	0.3093	0.2993		0.3028	0.3304		0.3115	0.3391		0.3161	0.3059
2A	0.3215	0.3350	2B	0.3207	0.3462	2C	0.3290	0.3538	2D	0.3290	0.3417
	0.3290	0.3417		0.3290	0.3538		0.3376	0.3616		0.3371	0.3490
	0.3290	0.3300		0.3290	0.3417		0.3371	0.3490		0.3366	0.3369
	0.3222	0.3243		0.3215	0.3350		0.3290	0.3417		0.3290	0.3300
2R	0.3222	0.3243	2S	0.3196	0.3602	2T	0.3290	0.3690	2U	0.3290	0.3300
	0.3290	0.3300		0.3290	0.3690		0.3381	0.3762		0.3366	0.3369
	0.3290	0.3180		0.3290	0.3538		0.3376	0.3616		0.3361	0.3245
	0.3231	0.3120		0.3207	0.3462		0.3290	0.3538		0.3290	0.3180
3A	0.3371	0.3490	3B	0.3376	0.3616	3C	0.3463	0.3687	3D	0.3451	0.3554
	0.3451	0.3554		0.3463	0.3687		0.3551	0.3760		0.3533	0.3620
	0.3440	0.3427		0.3451	0.3554		0.3533	0.3620		0.3515	0.3487
	0.3366	0.3369		0.3371	0.3490		0.3451	0.3554		0.3440	0.3427
3R	0.3366	0.3369	3S	0.3381	0.3762	3T	0.3480	0.3840	3U	0.3440	0.3428
	0.3440	0.3428		0.3480	0.3840		0.3571	0.3907		0.3515	0.3487
	0.3429	0.3307		0.3463	0.3687		0.3551	0.3760		0.3495	0.3339
	0.3361	0.3245		0.3376	0.3616		0.3463	0.3687		0.3429	0.3307
4A	0.3530	0.3597	4B	0.3548	0.3736	4C	0.3641	0.3804	4D	0.3615	0.3659
	0.3615	0.3659		0.3641	0.3804		0.3736	0.3874		0.3702	0.3722
	0.3590	0.3521		0.3615	0.3659		0.3702	0.3722		0.3670	0.3578
	0.3512	0.3465		0.3530	0.3597		0.3615	0.3659		0.3590	0.3521

PERFORMANCE GROUPS – CHROMATICITY (CONTINUED)

Region	x	y	Region	x	y	Region	x	y	Region	x	y		
5A1	0.3670	0.3578	5A2	0.3686	0.3649	5A3	0.3744	0.3685	5A4	0.3726	0.3612		
	0.3686	0.3649		0.3702	0.3722		0.3763	0.3760		0.3763	0.3760	0.3744	0.3685
	0.3744	0.3685		0.3763	0.3760		0.3825	0.3798		0.3804	0.3721	0.3804	0.3721
	0.3726	0.3612		0.3744	0.3685		0.3804	0.3721		0.3783	0.3646	0.3783	0.3646
5B1	0.3702	0.3722	5B2	0.3719	0.3797	5B3	0.3782	0.3837	5B4	0.3763	0.3760		
	0.3719	0.3797		0.3736	0.3874		0.3802	0.3916		0.3802	0.3916	0.3782	0.3837
	0.3782	0.3837		0.3802	0.3916		0.3869	0.3958		0.3869	0.3958	0.3847	0.3877
	0.3763	0.3760		0.3782	0.3837		0.3847	0.3877		0.3847	0.3877	0.3825	0.3798
5C1	0.3825	0.3798	5C2	0.3847	0.3877	5C3	0.3912	0.3917	5C4	0.3887	0.3836		
	0.3847	0.3877		0.3869	0.3958		0.3937	0.4001		0.3937	0.4001	0.3912	0.3917
	0.3912	0.3917		0.3937	0.4001		0.4006	0.4044		0.4006	0.4044	0.3978	0.3958
	0.3887	0.3836		0.3912	0.3917		0.3978	0.3958		0.3978	0.3958	0.3950	0.3875
5D1	0.3783	0.3646	5D2	0.3804	0.3721	5D3	0.3863	0.3758	5D4	0.3840	0.3681		
	0.3804	0.3721		0.3825	0.3798		0.3887	0.3836		0.3887	0.3836	0.3863	0.3758
	0.3863	0.3758		0.3887	0.3836		0.3950	0.3875		0.3950	0.3875	0.3924	0.3794
	0.3840	0.3681		0.3863	0.3758		0.3924	0.3794		0.3924	0.3794	0.3898	0.3716
6A1	0.3889	0.3690	6A2	0.3915	0.3768	6A3	0.3981	0.3800	6A4	0.3953	0.3720		
	0.3915	0.3768		0.3941	0.3848		0.4010	0.3882		0.4010	0.3882	0.3981	0.3800
	0.3981	0.3800		0.4010	0.3882		0.4080	0.3916		0.4080	0.3916	0.4048	0.3832
	0.3953	0.3720		0.3981	0.3800		0.4048	0.3832		0.4048	0.3832	0.4017	0.3751
6B1	0.3941	0.3848	6B2	0.3968	0.3930	6B3	0.4040	0.3966	6B4	0.4010	0.3882		
	0.3968	0.3930		0.3996	0.4015		0.4071	0.4052		0.4071	0.4052	0.4040	0.3966
	0.4040	0.3966		0.4071	0.4052		0.4146	0.4089		0.4146	0.4089	0.4113	0.4001
	0.4010	0.3882		0.4040	0.3966		0.4113	0.4001		0.4113	0.4001	0.4080	0.3916
6C1	0.4080	0.3916	6C2	0.4113	0.4001	6C3	0.4186	0.4037	6C4	0.4150	0.3950		
	0.4113	0.4001		0.4146	0.4089		0.4222	0.4127		0.4222	0.4127	0.4186	0.4037
	0.4186	0.4037		0.4222	0.4127		0.4299	0.4165		0.4299	0.4165	0.4259	0.4073
	0.4150	0.3950		0.4186	0.4037		0.4259	0.4073		0.4259	0.4073	0.4221	0.3984
6D1	0.4017	0.3751	6D2	0.4048	0.3832	6D3	0.4116	0.3865	6D4	0.4082	0.3782		
	0.4048	0.3832		0.4080	0.3916		0.4150	0.3950		0.4150	0.3950	0.4116	0.3865
	0.4116	0.3865		0.4150	0.3950		0.4221	0.3984		0.4221	0.3984	0.4183	0.3898
	0.4082	0.3782		0.4116	0.3865		0.4183	0.3898		0.4183	0.3898	0.4147	0.3814
7A1	0.4147	0.3814	7A2	0.4183	0.3898	7A3	0.4242	0.3919	7A4	0.4203	0.3833		
	0.4183	0.3898		0.4221	0.3984		0.4281	0.4006		0.4281	0.4006	0.4242	0.3919
	0.4242	0.3919		0.4281	0.4006		0.4342	0.4028		0.4342	0.4028	0.4300	0.3939
	0.4203	0.3833		0.4242	0.3919		0.4300	0.3939		0.4300	0.3939	0.4259	0.3853
7B1	0.4221	0.3984	7B2	0.4259	0.4073	7B3	0.4322	0.4096	7B4	0.4281	0.4006		
	0.4259	0.4073		0.4299	0.4165		0.4364	0.4188		0.4364	0.4188	0.4322	0.4096
	0.4322	0.4096		0.4364	0.4188		0.4430	0.4212		0.4430	0.4212	0.4385	0.4119
	0.4281	0.4006		0.4322	0.4096		0.4385	0.4119		0.4385	0.4119	0.4342	0.4028

PERFORMANCE GROUPS – CHROMATICITY (CONTINUED)

Region	x	y	Region	x	y	Region	x	y	Region	x	y
7C1	0.4342	0.4028	7C2	0.4385	0.4119	7C3	0.4449	0.4141	7C4	0.4403	0.4049
	0.4385	0.4119		0.4430	0.4212		0.4496	0.4236		0.4449	0.4141
	0.4449	0.4141		0.4496	0.4236		0.4562	0.4260		0.4513	0.4164
	0.4403	0.4049		0.4449	0.4141		0.4513	0.4164		0.4465	0.4071
7D1	0.4259	0.3853	7D2	0.4300	0.3939	7D3	0.4359	0.3960	7D4	0.4316	0.3873
	0.4300	0.3939		0.4342	0.4028		0.4403	0.4049		0.4359	0.3960
	0.4359	0.3960		0.4403	0.4049		0.4465	0.4071		0.4418	0.3981
	0.4316	0.3873		0.4359	0.3960		0.4418	0.3981		0.4373	0.3893
8A1	0.4373	0.3893	8A2	0.4418	0.3981	8A3	0.4475	0.3994	8A4	0.4428	0.3906
	0.4418	0.3981		0.4465	0.4071		0.4523	0.4085		0.4475	0.3994
	0.4475	0.3994		0.4523	0.4085		0.4582	0.4099		0.4532	0.4008
	0.4428	0.3906		0.4475	0.3994		0.4532	0.4008		0.4483	0.3919
8B1	0.4465	0.4071	8B2	0.4513	0.4164	8B3	0.4573	0.4178	8B4	0.4523	0.4085
	0.4513	0.4164		0.4562	0.4260		0.4624	0.4274		0.4573	0.4178
	0.4573	0.4178		0.4624	0.4274		0.4687	0.4289		0.4634	0.4193
	0.4523	0.4085		0.4573	0.4178		0.4634	0.4193		0.4582	0.4099
8C1	0.4582	0.4099	8C2	0.4634	0.4193	8C3	0.4695	0.4207	8C4	0.4641	0.4112
	0.4634	0.4193		0.4687	0.4289		0.4750	0.4304		0.4695	0.4207
	0.4695	0.4207		0.4750	0.4304		0.4813	0.4319		0.4756	0.4221
	0.4641	0.4112		0.4695	0.4207		0.4756	0.4221		0.4700	0.4126
8D1	0.4483	0.3919	8D2	0.4532	0.4008	8D3	0.4589	0.4021	8D4	0.4538	0.3931
	0.4532	0.4008		0.4582	0.4099		0.4641	0.4112		0.4589	0.4021
	0.4589	0.4021		0.4641	0.4112		0.4700	0.4126		0.4646	0.4034
	0.4538	0.3931		0.4589	0.4021		0.4646	0.4034		0.4593	0.3944

PERFORMANCE GROUPS – DOMINANT WAVELENGTH

Color XLamp LEDs are tested for dominant wavelength (DWL) and sorted into one of the DWL bins defined below.

Color	DWL Group	Min. DWL (nm) @ 350 mA	Max. DWL (nm) @ 350 mA
Blue	B3	465	470
	B4	470	475
	B5	475	480
	B6	480	485
Green	G2	520	525
	G3	525	530
	G4	530	535
Red	R2	620	625
	R3	625	630

CREE'S STANDARD WHITE CHROMATICITY REGIONS PLOTTED ON THE 1931 CIE CURVE

ANSI Cool White

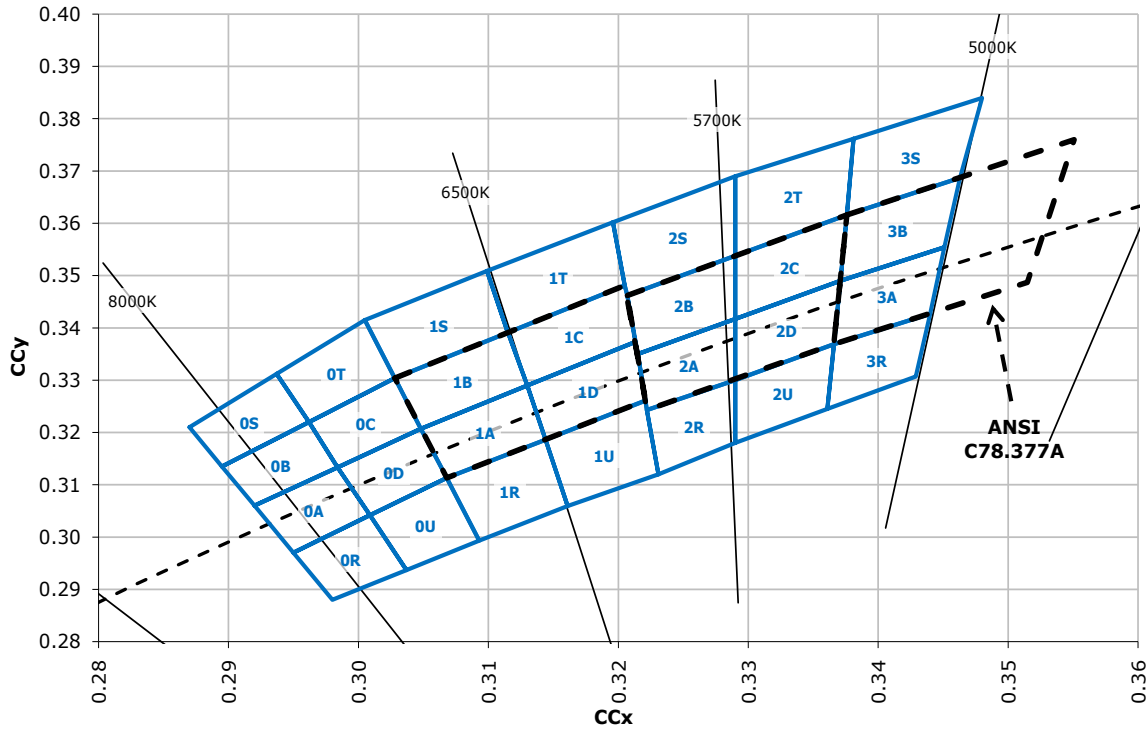

ANSI Neutral White and ANSI Warm White

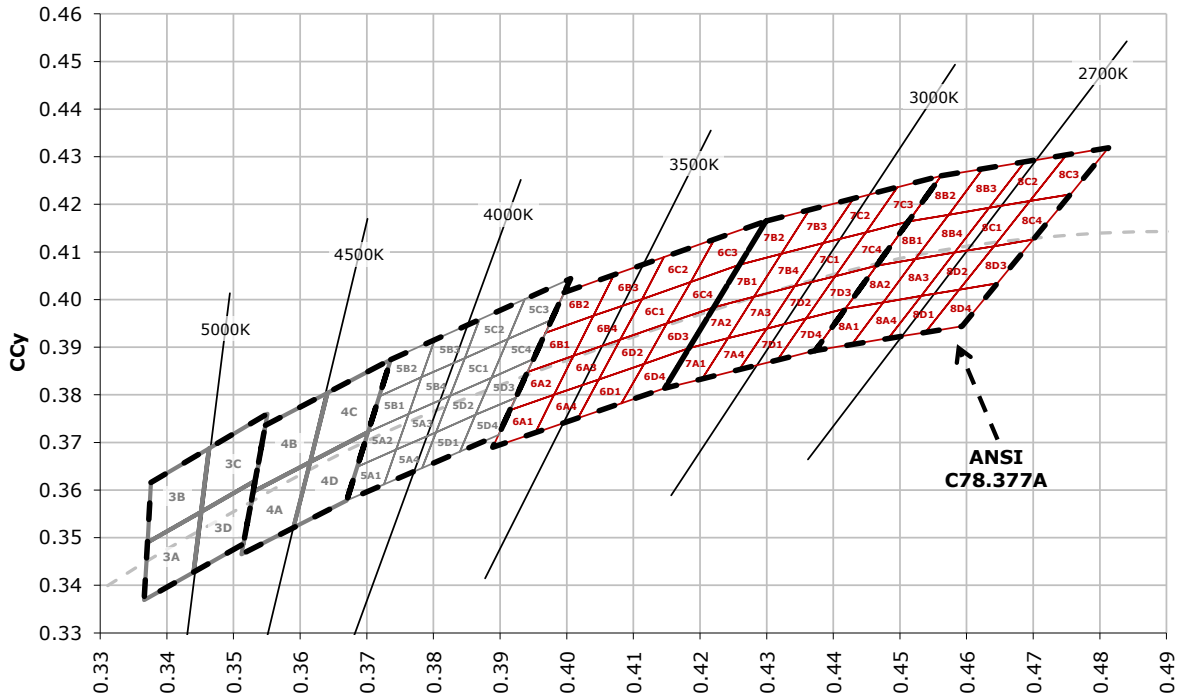

CREE'S STANDARD COOL WHITE KITS PLOTTED ON ANSI STANDARD CHROMATICITY REGIONS

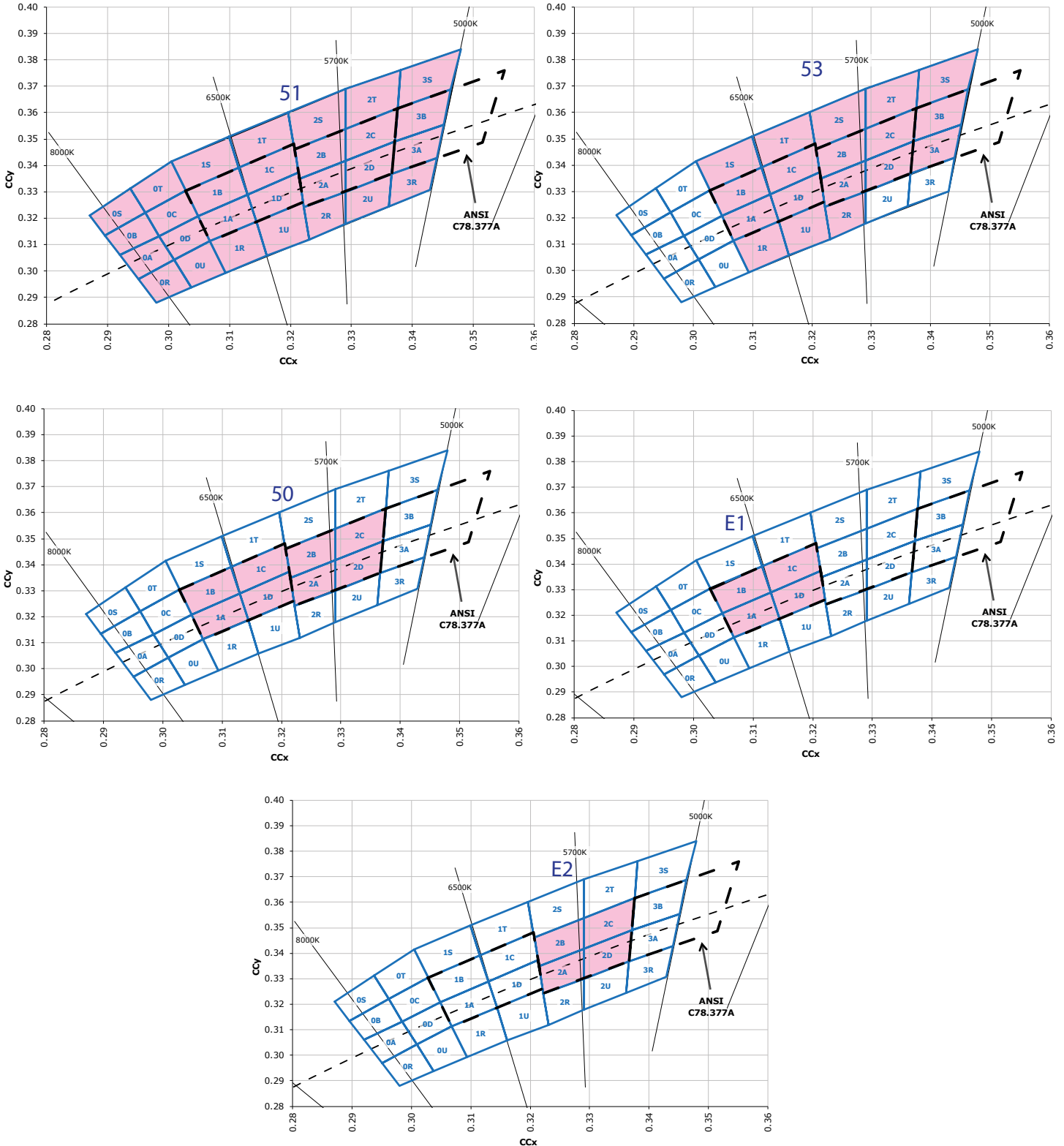

CREE'S STANDARD WARM AND NEUTRAL WHITE KITS PLOTTED ON ANSI STANDARD CHROMATICITY REGIONS

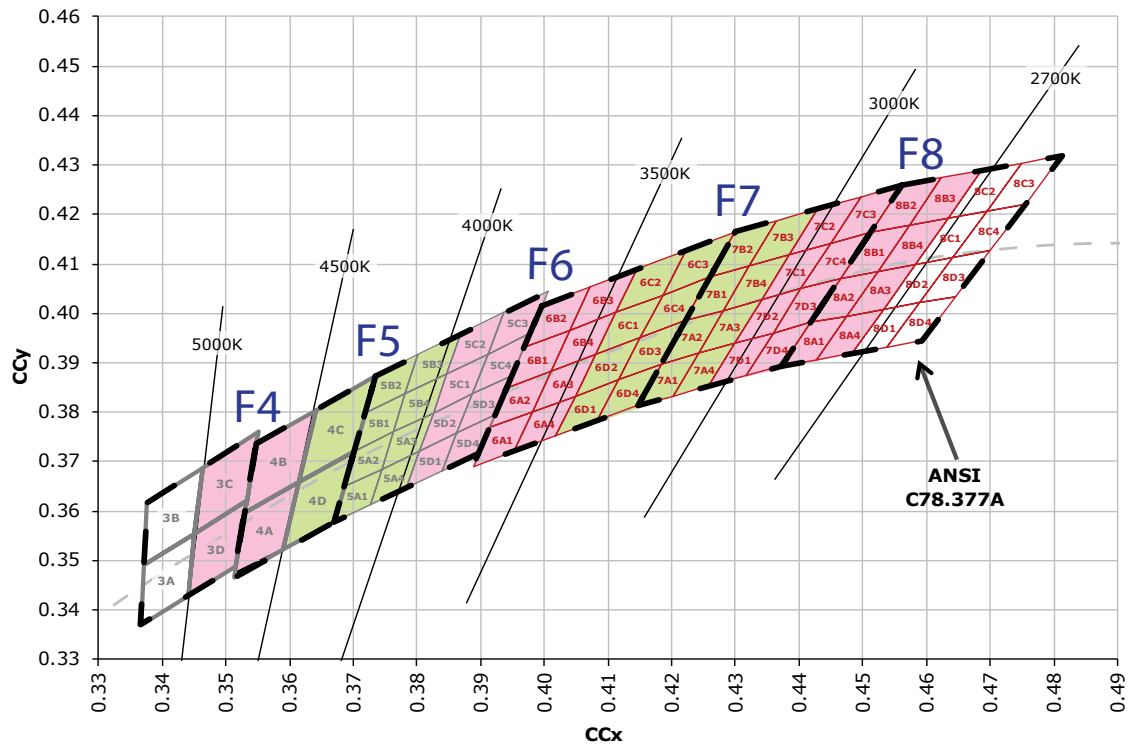
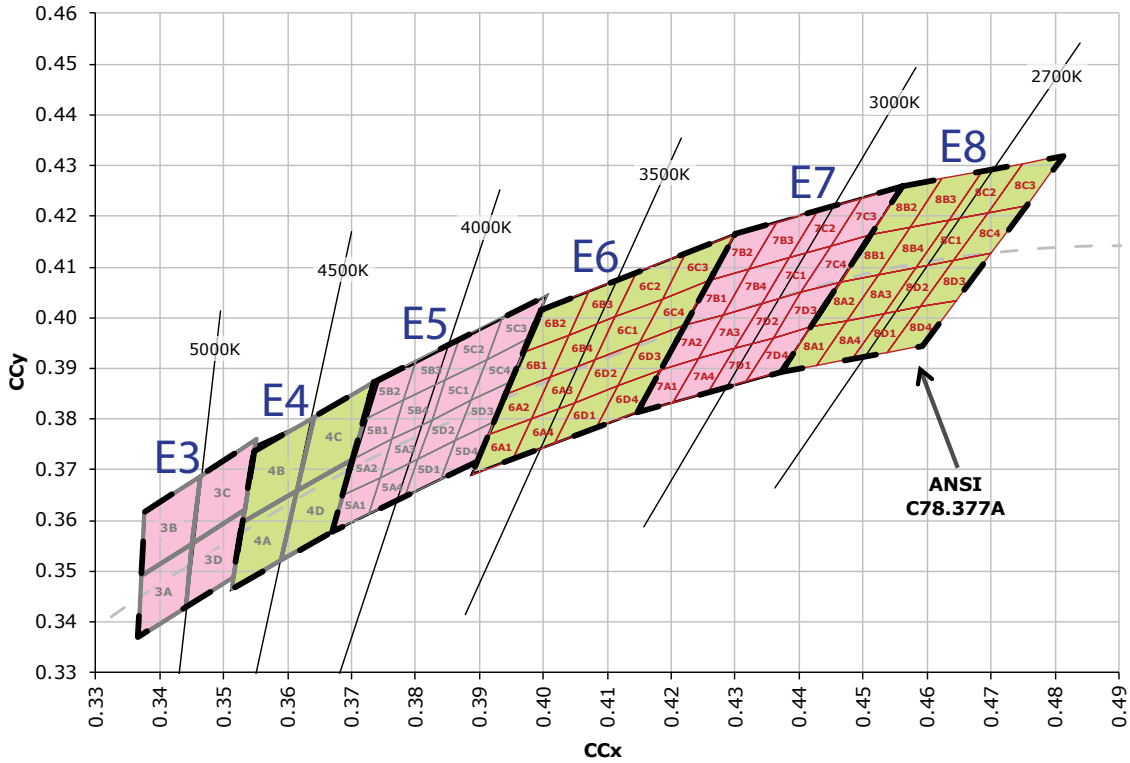

CREE'S STANDARD CHROMATICITY KITS

The following table provides the chromaticity bins associated with chromaticity kits.

Color	CCT	Kit	Chromaticity Bins
Cool White	6200 K	51	0A, 0B, 0C, 0D, 0R, 0S, 0T, 0U, 1A, 1B, 1C, 1D, 1R, 1S, 1T, 1U, 2A, 2B, 2C, 2D, 2R, 2S, 2T, 2U, 3A, 3B, 3R, 3S
	6000 K	53	1A, 1B, 1C, 1D, 1R, 1S, 1T, 1U, 2A, 2B, 2C, 2D, 2R, 2S, 2T, 3A, 3B, 3S
	6200 K	50	1A, 1B, 1C, 1D, 2A, 2B, 2C, 2D
	6500 K	E1	1A, 1B, 1C, 1D
	5700 K	E2	2A, 2B, 2C, 2D
Neutral White	5000 K	E3	3A, 3B, 3C, 3D
	5000 K	C1	3A, 3B, 3C, 3D, 3R, 3S, 3T, 3U, 4A, 4B, 4R, 4S
	4750 K	F4	3C, 3D, 4A, 4B
	4750 K	D1	3A, 3B, 3C, 3D, 3R, 3S, 3T, 3U, 4A, 4B, 4C, 4D, 4R, 4S, 4T, 4U
	4500 K	E4	4A, 4B, 4C, 4D
	4500 K	D2	3C, 3D, 3T, 3U, 4A, 4B, 4C, 4D, 4R, 4S, 4T, 4U, 5A1, 5A2, 5A3, 5A4, 5B1, 5B2, 5B3, 5B4, 5R, 5S
	4500 K	C2	3C, 3D, 3T, 3U, 4A, 4B, 4C, 4D, 4R, 4S, 4T, 4U
	4300 K	C3	4A, 4B, 4C, 4D, 4R, 4S, 4T, 4U, 5A1, 5A2, 5A3, 5A4, 5B1, 5B2, 5B3, 5B4, 5R, 5S
	4250 K	F5	4C, 4D, 5A1, 5A2, 5A3, 5A4, 5B1, 5B2, 5B3, 5B4
4000 K	E5	5A1, 5A2, 5A3, 5A4, 5B1, 5B2, 5B3, 5B4, 5C1, 5C2, 5C3, 5C4, 5D1, 5D2, 5D3, 5D4	
Warm White	3750 K	F6	5C1, 5C2, 5C3, 5C4, 5D1, 5D2, 5D3, 5D4, 6A1, 6A2, 6A3, 6A4, 6B1, 6B2, 6B3, 6B4
	3500 K	E6	6A1, 6A2, 6A3, 6A4, 6B1, 6B2, 6B3, 6B4, 6C1, 6C2, 6C3, 6C4, 6D1, 6D2, 6D3, 6D4
	3250 K	F7	6C1, 6C2, 6C3, 6C4, 6D1, 6D2, 6D3, 6D4, 7A1, 7A2, 7A3, 7A4, 7B1, 7B2, 7B3, 7B4
	3000 K	E7	7A1, 7A2, 7A3, 7A4, 7B1, 7B2, 7B3, 7B4, 7C1, 7C2, 7C3, 7C4, 7D1, 7D2, 7D3, 7D4
	2850 K	F8	7C1, 7C2, 7C3, 7C4, 7D1, 7D2, 7D3, 7D4, 8A1, 8A2, 8A3, 8A4, 8B1, 8B2, 8B3, 8B4
	2700 K	E8	8A1, 8A2, 8A3, 8A4, 8B1, 8B2, 8B3, 8B4, 8C1, 8C2, 8C3, 8C4, 8D1, 8D2, 8D3, 8D4

The following tables of order codes list flux minimums and chromaticity regions for the various categories of XLamp XQ LEDs. For other flux and chromaticity combinations, contact Cree or an authorized distributor.

STANDARD ORDER CODES AND BINS (XQ-B ANSI COOL WHITE, T_j = 25 °C)

XLamp XQ-B Standard Kit Codes - White						
Chromaticity		Minimum Luminous Flux (lm) @ 80 mA		Order Codes		
Kit	CCT	Code	Flux (lm)	No Minimum CRI	70 CRI Minimum	80 CRI Minimum
ANSI Cool White (5000 K – 8300 K)						
51	6200 K	K2	30.6	XQBAWT-00-0000-00000L051	XQBAWT-00-0000-00000B051	
53	6000 K	K2	30.6	XQBAWT-00-0000-00000L053	XQBAWT-00-0000-00000B053	
50	6200 K	K2	30.6	XQBAWT-00-0000-00000L050	XQBAWT-00-0000-00000B050	
E1	6500 K	K2	30.6	XQBAWT-00-0000-00000L0E1	XQBAWT-00-0000-00000B0E1	
E2	5700 K	K2	30.6	XQBAWT-00-0000-00000L0E2	XQBAWT-00-0000-00000B0E2	XQBAWT-00-0000-00000H0E2

STANDARD ORDER CODES AND BINS (XQ-B NEUTRAL WHITE, T_j = 25 °C)

XLamp XQ-B Standard Kit Codes - White						
Chromaticity		Minimum Luminous Flux (lm) @ 80 mA		Order Codes		
Kit	CCT	Code	Flux (lm)	70 CRI Minimum	75 CRI Typical	80 CRI Minimum
ANSI Neutral White (3700 K – 5000 K)						
E3	5000 K	K2	30.6	XQBAWT-00-0000-00000B0E3	XQBAWT-00-0000-00000L0E3	XQBAWT-00-0000-00000H0E3
		J3	26.5			XQBAWT-00-0000-00000HXE3
F4	4750 K	K2	30.6	XQBAWT-00-0000-00000B0F4	XQBAWT-00-0000-00000L0F4	XQBAWT-00-0000-00000H0F4
		J3	26.5			XQBAWT-00-0000-00000HXF4
E4	4500 K	K2	30.6	XQBAWT-00-0000-00000B0E4	XQBAWT-00-0000-00000L0E4	XQBAWT-00-0000-00000H0E4
		J3	26.5			XQBAWT-00-0000-00000HXE4
F5	4250 K	K2	30.6	XQBAWT-00-0000-00000B0F5	XQBAWT-00-0000-00000L0F5	XQBAWT-00-0000-00000H0F5
		J3	26.5	XQBAWT-00-0000-00000BXF5		XQBAWT-00-0000-00000HXF5
E5	4000 K	K2	30.6	XQBAWT-00-0000-00000B0E5	XQBAWT-00-0000-00000L0E5	XQBAWT-00-0000-00000H0E5
		J3	26.5	XQBAWT-00-0000-00000BXE5		XQBAWT-00-0000-00000HXE5
		J2	23.5			XQBAWT-00-0000-00000HWE5

- Notes:
- Cree maintains a tolerance of ±7% on flux and power measurements, ±0.005 on chromaticity (CCx, CCy) measurements and ±2 on CRI measurements.
 - Cree XLamp XQ Family order codes specify only a minimum flux bin and not a maximum. Cree may ship reels in flux bins higher than the minimum specified by the order code without advance notice. Shipments will always adhere to the chromaticity or DWL bin restrictions specified by the order code

STANDARD ORDER CODES AND BINS (XQ-B WARM WHITE, $T_j = 25\text{ }^\circ\text{C}$)

XLamp XQ-B Standard Kit Codes - White								
Chromaticity		Minimum Luminous Flux (lm) @ 80 mA		Order Codes: XQBWT-00-(+ extension below)				
Kit	CCT	Code	Flux (lm)	70 CRI Minimum	80 CRI Typical	80 CRI Minimum	85 CRI Minimum	90 CRI Minimum
ANSI Warm White (2700 K - 3750 K)								
F6	3750 K	K2	30.6	0000-00000B0F6	0000-00000L0F6	0000-00000H0F6		
		J3	26.5	0000-00000BXF6	0000-00000LXF6	0000-00000HXF6		
E6	3500 K	K2	30.6	0000-00000B0E6	0000-00000L0E6	0000-00000H0E6		
		J3	26.5	0000-00000BXE6	0000-00000LXE6	0000-00000HXE6		
F7	3250 K	K2	30.6	0000-00000B0F7	0000-00000L0F7			
		J3	26.5	0000-00000BXF7	0000-00000LXF7	0000-00000HXF7		
		J2	23.5			0000-00000HWF7		
E7	3000 K	K2	30.6	0000-00000B0E7	0000-00000L0E7			
		J3	26.5	0000-00000BXE7	0000-00000LXE7	0000-00000HXE7		
		J2	23.5			0000-00000HWE7	0000-00000PWE7	0000-00000UWE7
		H0	18.1				0000-00000PVE7	0000-00000UVE7
F8	2850 K	K2	30.6	0000-00000B0F8	0000-00000L0F8			
		J3	26.5	0000-00000BXF8	0000-00000LXF8	0000-00000HXF8		
		J2	23.5			0000-00000HWF8	0000-00000PWF8	0000-00000UWF8
		H0	18.1				0000-00000PVF8	0000-00000UVF8
E8	2700 K	K2	30.6	0000-00000B0E8	0000-00000L0E8			
		J3	26.5	0000-00000BXE8	0000-00000LXE8	0000-00000HXE8		
		J2	23.5			0000-00000HWE8	0000-00000PWE8	0000-00000UWE8
		H0	18.1				0000-00000PVE8	0000-00000UVE8

- Notes:
- Cree maintains a tolerance of $\pm 7\%$ on flux and power measurements, ± 0.005 on chromaticity (CCx, CCy) measurements and ± 2 on CRI measurements.
 - Cree XLamp XQ Family order codes specify only a minimum flux bin and not a maximum. Cree may ship reels in flux bins higher than the minimum specified by the order code without advance notice. Shipments will always adhere to the chromaticity or DWL bin restrictions specified by the order code.

STANDARD ORDER CODES AND BINS (XQ-D ANSI COOL WHITE, T_j = 25 °C)

XLamp XQ-D Standard Kit Codes - White						
Chromaticity		Minimum Luminous Flux (lm) @ 350 mA		Order Codes		
Kit	CCT	Code	Flux (lm)	No Minimum CRI	70 CRI Minimum	80 CRI Minimum
ANSI Cool White (5000 K – 8300 K)						
51	6200 K	R4	130		XQDAWT-00-0000-00000BG51	
		R3	122	XQDAWT-00-0000-00000LF51	XQDAWT-00-0000-00000BF51	XQDAWT-00-0000-00000HF51
		R2	114	XQDAWT-00-0000-00000LE51	XQDAWT-00-0000-00000BE51	XQDAWT-00-0000-00000HE51
53	6000 K	R4	130		XQDAWT-00-0000-00000BG53	
		R3	122	XQDAWT-00-0000-00000LF53	XQDAWT-00-0000-00000BF53	XQDAWT-00-0000-00000HF53
		R2	114	XQDAWT-00-0000-00000LE53	XQDAWT-00-0000-00000BE53	XQDAWT-00-0000-00000HE53
50	6200 K	R4	130		XQDAWT-00-0000-00000BG50	
		R3	122	XQDAWT-00-0000-00000LF50	XQDAWT-00-0000-00000BF50	XQDAWT-00-0000-00000HF50
		R2	114	XQDAWT-00-0000-00000LE50	XQDAWT-00-0000-00000BE50	XQDAWT-00-0000-00000HE50
E1	6500 K	R4	130		XQDAWT-00-0000-00000BGE1	
		R3	122	XQDAWT-00-0000-00000LFE1	XQDAWT-00-0000-00000BFE1	XQDAWT-00-0000-00000HFE1
		R2	114	XQDAWT-00-0000-00000LEE1	XQDAWT-00-0000-00000BEE1	XQDAWT-00-0000-00000HEE1
		Q5	107			XQDAWT-00-0000-00000HDE1
E2	5700 K	R4	130		XQDAWT-00-0000-00000BGE2	
		R3	122	XQDAWT-00-0000-00000LFE2	XQDAWT-00-0000-00000BFE2	XQDAWT-00-0000-00000HFE2
		R2	114	XQDAWT-00-0000-00000LEE2	XQDAWT-00-0000-00000BEE2	XQDAWT-00-0000-00000HEE2
		Q5	107			XQDAWT-00-0000-00000HDE2

- Notes:
- Cree maintains a tolerance of ±7% on flux and power measurements, ±0.005 on chromaticity (CCx, CCy) measurements and ±2 on CRI measurements.
 - Cree XLamp XQ Family order codes specify only a minimum flux bin and not a maximum. Cree may ship reels in flux bins higher than the minimum specified by the order code without advance notice. Shipments will always adhere to the chromaticity or DWL bin restrictions specified by the order code

STANDARD ORDER CODES AND BINS (XQ-D NEUTRAL WHITE, T_j = 25 °C)

XLamp XQ-D Standard Kit Codes - White						
Chromaticity		Minimum Luminous Flux (lm) @ 350 mA		Order Codes		
Kit	CCT	Code	Flux (lm)	70 CRI Minimum	75 CRI Typical	80 CRI Minimum
ANSI Neutral White (3700 K – 5000 K)						
E3	5000 K	R4	130	XQDAWT-00-0000-00000BGE3		
		R3	122	XQDAWT-00-0000-00000BFE3	XQDAWT-00-0000-00000LFE3	XQDAWT-00-0000-00000HFE3
		R2	114	XQDAWT-00-0000-00000BEE3	XQDAWT-00-0000-00000LEE3	XQDAWT-00-0000-00000HEE3
F4	4750 K	R4	130	XQDAWT-00-0000-00000BGF4		
		R3	122	XQDAWT-00-0000-00000BFF4	XQDAWT-00-0000-00000LFF4	XQDAWT-00-0000-00000HFF4
		R2	114	XQDAWT-00-0000-00000BEF4	XQDAWT-00-0000-00000LEF4	XQDAWT-00-0000-00000HEF4
		Q5	107		XQDAWT-00-0000-00000LDF4	XQDAWT-00-0000-00000HDF4
E4	4500 K	R4	130	XQDAWT-00-0000-00000BGE4		
		R3	122	XQDAWT-00-0000-00000BFE4	XQDAWT-00-0000-00000LFE4	XQDAWT-00-0000-00000HFE4
		R2	114	XQDAWT-00-0000-00000BEE4	XQDAWT-00-0000-00000LEE4	XQDAWT-00-0000-00000HEE4
		Q5	107		XQDAWT-00-0000-00000LDE4	XQDAWT-00-0000-00000HDE4
F5	4250 K	R3	122	XQDAWT-00-0000-00000BFF5		
		R2	114	XQDAWT-00-0000-00000BEF5	XQDAWT-00-0000-00000LEF5	XQDAWT-00-0000-00000HEF5
		Q5	107		XQDAWT-00-0000-00000LDF5	XQDAWT-00-0000-00000HDF5
E5	4000 K	R3	122	XQDAWT-00-0000-00000BFE5		
		R2	114	XQDAWT-00-0000-00000BEE5	XQDAWT-00-0000-00000LEE5	XQDAWT-00-0000-00000HEE5
		Q5	107		XQDAWT-00-0000-00000LDE5	XQDAWT-00-0000-00000HDE5

- Notes:
- Cree maintains a tolerance of ±7% on flux and power measurements, ±0.005 on chromaticity (CCx, CCy) measurements and ±2 on CRI measurements.
 - Cree XLamp XQ Family order codes specify only a minimum flux bin and not a maximum. Cree may ship reels in flux bins higher than the minimum specified by the order code without advance notice. Shipments will always adhere to the chromaticity or DWL bin restrictions specified by the order code

STANDARD ORDER CODES AND BINS (XQ-D WARM WHITE, $T_j = 25\text{ }^\circ\text{C}$)

XLamp XQ-D Standard Kit Codes - White								
Chromaticity		Minimum Luminous Flux (lm) @ 350 mA		Order Codes Order Codes: XQDAWT-00-(+ extension below)				
Kit	CCT	Code	Flux (lm)	70 CRI Minimum	80 CRI Typical	80 CRI Minimum	85 CRI Minimum	90 CRI Minimum
ANSI Warm White (2700 K - 3750 K)								
F6	3750 K	R3	122	0000-00000BFF6				
		R2	114	0000-00000BEF6	0000-00000LEF6	0000-00000HEF6		
		Q5	107	0000-00000BDF6	0000-00000LDF6	0000-00000HDF6		
		Q4	100			0000-00000HCF6		
E6	3500 K	R3	122	0000-00000BFE6				
		R2	114	0000-00000BEE6	0000-00000LEE6	0000-00000HEE6		
		Q5	107	0000-00000BDE6	0000-00000LDE6	0000-00000HDE6		
		Q4	100			0000-00000HCE6		
F7	3250 K	R3	122	0000-00000BFF7				
		R2	114	0000-00000BEF7	0000-00000LEF7	0000-00000HEF7		
		Q5	107	0000-00000BDF7	0000-00000LDF7	0000-00000HDF7		
		Q4	100		0000-00000LCF7	0000-00000HCF7		
E7	3000 K	R3	122	0000-00000BFE7				
		R2	114	0000-00000BEE7	0000-00000LEE7	0000-00000HEE7		
		Q5	107	0000-00000BDE7	0000-00000LDE7	0000-00000HDE7		
		Q4	100		0000-00000LCE7	0000-00000HCE7		
		Q3	93.9				0000-00000PBE7	
		Q2	87.4				0000-00000PAE7	0000-00000UAE7
		P4	80.6				0000-00000P9E7	0000-00000U9E7
F8	2850 K	R2	114	0000-00000BEF8				
		Q5	107	0000-00000BDF8	0000-00000LDF8	0000-00000HDF8		
		Q4	100	0000-00000BCF8	0000-00000LCF8	0000-00000HCF8		
		Q3	93.9			0000-00000HBF8		
		Q2	87.4					
		P4	80.6				0000-00000P9F8	
E8	2700 K	R2	114	0000-00000BEE8				
		Q5	107	0000-00000BDE8	0000-00000LDE8	0000-00000HDE8		
		Q4	100	0000-00000BCE8	0000-00000LCE8	0000-00000HCE8		
		Q3	93.9			0000-00000HBE8		
		Q2	87.4				0000-00000PAE8	0000-00000UAE8
		P4	80.6				0000-00000P9E8	0000-00000U9E8

- Notes:
- Cree maintains a tolerance of $\pm 7\%$ on flux and power measurements, ± 0.005 on chromaticity (CCx, CCy) measurements and ± 2 on CRI measurements.
 - Cree XLamp XQ Family order codes specify only a minimum flux bin and not a maximum. Cree may ship reels in flux bins higher than the minimum specified by the order code without advance notice. Shipments will always adhere to the chromaticity or DWL bin restrictions specified by the order code

STANDARD ORDER CODES AND BINS (XQ-E ANSI COOL WHITE, $T_j = 85\text{ }^\circ\text{C}$)

XLamp XQ-E Standard Kit Codes - White					
Chromaticity		Minimum Luminous Flux (lm) @ 350 mA		Order Codes	
Kit	CCT	Code	Flux (lm)	70 CRI Typical	70 CRI Minimum
ANSI Cool White (5000 K - 8300 K)					
51	6200 K	R3	122	XQEAWT-00-0000-00000LF51	XQEAWT-00-0000-00000BF51
		R2	114	XQEAWT-00-0000-00000LE51	XQEAWT-00-0000-00000BE51
		Q5	107	XQEAWT-00-0000-00000LD51	XQEAWT-00-0000-00000BD51
53	6000 K	R3	122	XQEAWT-00-0000-00000LF53	XQEAWT-00-0000-00000BF53
		R2	114	XQEAWT-00-0000-00000LE53	XQEAWT-00-0000-00000BE53
		Q5	107	XQEAWT-00-0000-00000LD53	XQEAWT-00-0000-00000BD53
50	6200 K	R3	122	XQEAWT-00-0000-00000LF50	XQEAWT-00-0000-00000BF50
		R2	114	XQEAWT-00-0000-00000LE50	XQEAWT-00-0000-00000BE50
		Q5	107	XQEAWT-00-0000-00000LD50	XQEAWT-00-0000-00000BD50
E1	6500 K	R3	122	XQEAWT-00-0000-00000LFE1	XQEAWT-00-0000-00000BFE1
		R2	114	XQEAWT-00-0000-00000LEE1	XQEAWT-00-0000-00000BEE1
		Q5	107	XQEAWT-00-0000-00000LDE1	XQEAWT-00-0000-00000BDE1
E2	5700 K	R3	122	XQEAWT-00-0000-00000LFE2	XQEAWT-00-0000-00000BFE2
		R2	114	XQEAWT-00-0000-00000LEE2	XQEAWT-00-0000-00000BEE2
		Q5	107	XQEAWT-00-0000-00000LDE2	XQEAWT-00-0000-00000BDE2

- Notes:
- Cree maintains a tolerance of $\pm 7\%$ on flux and power measurements, ± 0.005 on chromaticity (CCx, CCy) measurements and ± 2 on CRI measurements.
 - Cree XLamp XQ Family order codes specify only a minimum flux bin and not a maximum. Cree may ship reels in flux bins higher than the minimum specified by the order code without advance notice. Shipments will always adhere to the chromaticity or DWL bin restrictions specified by the order code

STANDARD ORDER CODES AND BINS (XQ-E NEUTRAL WHITE, T_j = 85 °C)

XLamp XQ-E Standard Kit Codes - White						
Chromaticity		Minimum Luminous Flux (lm) @ 350 mA		Order Codes		
Kit	CCT	Code	Flux (lm)	70 CRI Minimum	75 CRI Typical	80 CRI Minimum
ANSI Neutral White (3700 K – 5000 K)						
E3	5000 K	R2	114	XQEAWT-00-0000-00000BEE3	XQEAWT-00-0000-00000LEE3	
		Q5	107	XQEAWT-00-0000-00000BDE3	XQEAWT-00-0000-00000LDE3	
		Q4	100		XQEAWT-00-0000-00000LCE3	
F4	4750 K	R2	114	XQEAWT-00-0000-00000BEF4		
		Q5	107	XQEAWT-00-0000-00000BDF4	XQEAWT-00-0000-00000LDF4	
		Q4	100	XQEAWT-00-0000-00000BCF4	XQEAWT-00-0000-00000LCF4	
		Q3	93.9		XQEAWT-00-0000-00000LBF4	
E4	4500 K	R2	114	XQEAWT-00-0000-00000BEE4		
		Q5	107	XQEAWT-00-0000-00000BDE4	XQEAWT-00-0000-00000LDE4	
		Q4	100	XQEAWT-00-0000-00000BCE4	XQEAWT-00-0000-00000LCE4	
		Q3	93.9		XQEAWT-00-0000-00000LBE4	
F5	4250 K	R2	114	XQEAWT-00-0000-00000BEF5		
		Q5	107	XQEAWT-00-0000-00000BDF5	XQEAWT-00-0000-00000LDF5	XQEAWT-00-0000-00000HDF5
		Q4	100	XQEAWT-00-0000-00000BCF5	XQEAWT-00-0000-00000LCF5	XQEAWT-00-0000-00000HCF5
		Q3	93.9		XQEAWT-00-0000-00000LBF5	XQEAWT-00-0000-00000HBF5
E5	4000 K	R2	114	XQEAWT-00-0000-00000BEE5		
		Q5	107	XQEAWT-00-0000-00000BDE5	XQEAWT-00-0000-00000LDE5	XQEAWT-00-0000-00000HDE5
		Q4	100	XQEAWT-00-0000-00000BCE5	XQEAWT-00-0000-00000LCE5	XQEAWT-00-0000-00000HCE5
		Q3	93.9		XQEAWT-00-0000-00000LBE5	XQEAWT-00-0000-00000HBE5

- Notes:
- Cree maintains a tolerance of ±7% on flux and power measurements, ±0.005 on chromaticity (CCx, CCy) measurements and ±2 on CRI measurements.
 - Cree XLamp XQ Family order codes specify only a minimum flux bin and not a maximum. Cree may ship reels in flux bins higher than the minimum specified by the order code without advance notice. Shipments will always adhere to the chromaticity or DWL bin restrictions specified by the order code

STANDARD ORDER CODES AND BINS (XQ-E WARM WHITE, T_j = 85 °C)

XLamp XQ-E Standard Kit Codes - White					
Chromaticity		Minimum Luminous Flux (lm) @ 350 mA		Order Codes	
Kit	CCT	Code	Flux (lm)	80 CRI Typical	80 CRI Minimum
ANSI Warm White (2700 K - 3750 K)					
F6	3750 K	Q4	100	XQEAWT-00-0000-00000LCF6	XQEAWT-00-0000-00000HCF6
		Q3	93.9	XQEAWT-00-0000-00000LBF6	XQEAWT-00-0000-00000HBF6
		Q2	87.4	XQEAWT-00-0000-00000LAF6	XQEAWT-00-0000-00000HAF6
E6	3500 K	Q4	100	XQEAWT-00-0000-00000LCE6	XQEAWT-00-0000-00000HCE6
		Q3	93.9	XQEAWT-00-0000-00000LBE6	XQEAWT-00-0000-00000HBE6
		Q2	87.4	XQEAWT-00-0000-00000LAE6	XQEAWT-00-0000-00000HAE6
F7	3250 K	Q4	100	XQEAWT-00-0000-00000LCF7	XQEAWT-00-0000-00000HCF7
		Q3	93.9	XQEAWT-00-0000-00000LBF7	XQEAWT-00-0000-00000HBF7
		Q2	87.4	XQEAWT-00-0000-00000LAF7	XQEAWT-00-0000-00000HAF7
		P4	80.6	XQEAWT-00-0000-00000L9F7	XQEAWT-00-0000-00000H9F7
E7	3000 K	Q4	100	XQEAWT-00-0000-00000LCE7	XQEAWT-00-0000-00000HCE7
		Q3	93.9	XQEAWT-00-0000-00000LBE7	XQEAWT-00-0000-00000HBE7
		Q2	87.4	XQEAWT-00-0000-00000LAE7	XQEAWT-00-0000-00000HAE7
		P4	80.6	XQEAWT-00-0000-00000L9E7	XQEAWT-00-0000-00000H9E7
F8	2850 K	Q3	93.9	XQEAWT-00-0000-00000LBF8	XQEAWT-00-0000-00000HBF8
		Q2	87.4	XQEAWT-00-0000-00000LAF8	XQEAWT-00-0000-00000HAF8
		P4	80.6	XQEAWT-00-0000-00000L9F8	XQEAWT-00-0000-00000H9F8
E8	2700 K	Q3	93.9	XQEAWT-00-0000-00000LBE8	XQEAWT-00-0000-00000HBE8
		Q2	87.4	XQEAWT-00-0000-00000LAE8	XQEAWT-00-0000-00000HAE8
		P4	80.6	XQEAWT-00-0000-00000L9E8	XQEAWT-00-0000-00000H9E8

- Notes:
- Cree maintains a tolerance of ±7% on flux and power measurements, ±0.005 on chromaticity (CCx, CCy) measurements and ±2 on CRI measurements.
 - Cree XLamp XQ Family order codes specify only a minimum flux bin and not a maximum. Cree may ship reels in flux bins higher than the minimum specified by the order code without advance notice. Shipments will always adhere to the chromaticity or DWL bin restrictions specified by the order code

STANDARD ORDER CODES AND BINS (XQ-E COLOR, T_j = 25 °C)

XLamp XQ-E LED Standard Order Codes - Color							
Color	Min. Luminous Flux (lm) @ 350 mA*		Dominant Wavelength (nm)				Order Codes
	Group	Flux (lm)	Min.		Max.		
			Group	DWL (nm)	Group	DWL (nm)	
Blue	M2	39.8	B3	465	B6	485	XQEBLU-00-0000-000000201
			B3	465	B5	480	XQEBLU-00-0000-000000202
			B4	470	B5	480	XQEBLU-00-0000-000000205
	K3	35.2	B3	465	B6	485	XQEBLU-00-0000-000000Z01
			B3	465	B5	480	XQEBLU-00-0000-000000Z02
			B4	470	B5	480	XQEBLU-00-0000-000000Z05
	K2	30.6	B3	465	B6	485	XQEBLU-00-0000-000000Y01
			B3	465	B5	480	XQEBLU-00-0000-000000Y02
			B4	470	B5	480	XQEBLU-00-0000-000000Y05
Green	R2	114	G2	520	G4	535	XQEGRN-00-0000-000000E01
			G2	520	G3	530	XQEGRN-00-0000-000000E02
			G3	525	G4	535	XQEGRN-00-0000-000000E03
	Q5	107	G2	520	G4	535	XQEGRN-00-0000-000000D01
			G2	520	G3	530	XQEGRN-00-0000-000000D02
			G3	525	G4	535	XQEGRN-00-0000-000000D03
	Q4	100	G2	520	G4	535	XQEGRN-00-0000-000000C01
			G2	520	G3	530	XQEGRN-00-0000-000000C02
			G3	525	G4	535	XQEGRN-00-0000-000000C03
	Q3	93.9	G2	520	G4	535	XQEGRN-00-0000-000000B01
			G2	520	G3	530	XQEGRN-00-0000-000000B02
			G3	525	G4	535	XQEGRN-00-0000-000000B03
Red	P3	73.9	R2	620	R3	630	XQERED-00-0000-000000801
			R2	620	R2	625	XQERED-00-0000-000000802
	P2	67.2	R2	620	R3	630	XQERED-00-0000-000000701
			R2	620	R2	625	XQERED-00-0000-000000702
	N4	62	R2	620	R3	630	XQERED-00-0000-000000601
			R2	620	R2	625	XQERED-00-0000-000000602
	N3	56.8	R2	620	R3	630	XQERED-00-0000-000000501
			R2	620	R2	625	XQERED-00-0000-000000502

- Notes:
- Cree maintains a tolerance of ±7% on flux and power measurements, ±0.005 on chromaticity (CCx, CCy) measurements and ±2 on CRI measurements.
 - Cree XLamp XQ Family order codes specify only a minimum flux bin and not a maximum. Cree may ship reels in flux bins higher than the minimum specified by the order code without advance notice. Shipments will always adhere to the chromaticity or DWL bin restrictions specified by the order code