

# Low-Noise Operational Amplifier

## GENERAL DESCRIPTION

The XR-5534 is a high performance low-noise operational amplifier especially designed for application in high quality and professional audio equipment. It offers five-fold improvement in noise characteristics, output drive capability and full-power bandwidth over conventional 741-type op amps. The op amp is internally compensated for gain equal to, or higher than, three. The frequency response can be optimized with an external compensation capacitor for various applications such as operating in unity gain mode or driving capacitive loads.

The XR-5534A is a specially-screened version of the XR-5534, with guaranteed noise specifications.

## FEATURES

- Direct Replacement for Signetics NE/SE 5534
- Wide Small-Signal Bandwidth: 10 MHz
- High-Current Drive Capability
  - (10V rms into 600Ω at  $V_S = \pm 18V$ )
- High Slew Rate: 13 V/μs
- Wide Power-Bandwidth: 200 kHz typ.
- Very Low Input Noise: 4 nV/√Hz typ.

## APPLICATIONS

- High Quality Audio Amplification
- Telephone Channel Amplifiers
- Servo Control Systems
- Low-Level Signal Detection
- Active Filter Design

## ABSOLUTE MAXIMUM RATINGS

Power Supply	± 22 V
Input Common-Mode Voltage	+V <sub>CC</sub> to -V <sub>EE</sub>
Differential Input Voltage (Note 1)	± 0.5 V
Power Dissipation (Package Limitation)	
Ceramic Package	750 mW
Plastic Package	625 mW
Derate Above +24°C	2.5 mW/°C
Short Circuit Duration (Note 2)	Indefinite
Storage Temperature	-60°C to +150°C

Note 1: Diodes protect the inputs against over-voltage. Therefore, unless current-limiting resistors are used, large currents will flow if the differential input voltage exceeds 0.6V. Maximum current should be limited to ± 10 mA.

Note 2: Output may be shorted to ground at  $V_S = \pm 15V$ ,  $T_A = 25°C$ . Temperature and/or supply voltages must be limited to ensure dissipation rating is not exceeded.

Note 3: Operation near the absolute maximum ratings will exceed the power dissipation rating of the package.

## FUNCTIONAL BLOCK DIAGRAM

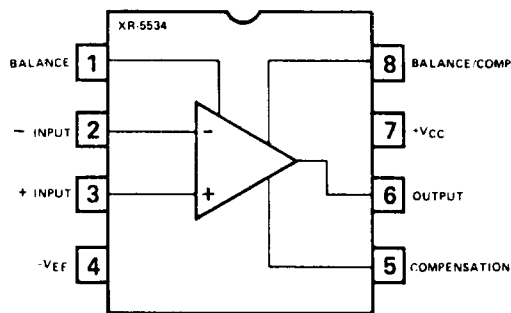

## ORDERING INFORMATION

Part Number	Package	Operating Temperature
5534AM	Ceramic	-55°C to +125°C
5534M	Ceramic	-55°C to +125°C
5534ACN	Ceramic	0°C to +70°C
5534CN	Ceramic	0°C to +70°C
5534ACP	Plastic	0°C to +70°C
5534CP	Plastic	0°C to +70°C

## SYSTEM DESCRIPTION

The XR-5534 and XR-5534A are monolithic operational amplifiers featuring low noise and a very large gain bandwidth product. The devices offer low output resistance and can drive 10 V<sub>rms</sub> into 600Ω. Input noise is 100% tested on the XR-5534A, and is typically only 4 nV/√Hz. The small signal bandwidth is 10 MHz and slew rate exceeds 13 V/μs.

Reverse parallel diodes provide input protection; maximum differential input voltage is 0.7 V. Balance pins are provided to zero offset voltage. The device is internally compensated for gains ≥ 3 and provides external compensation pins for unity gain applications. Supply voltage may range from ±3V to ±20V.

For driving capacitive loads, an adjustment of the compensation can be made. The slew rate vs. compensation capacitor graph should be referenced. Slew rate has a large effect on op amp stability when driving capacitor loads.

# XR-5534/5534A

## ELECTRICAL CHARACTERISTICS

Test Conditions:  $T_A = 25^\circ\text{C}$ ,  $V_{CC} = |V_{EE}| = 15\text{V}$ , unless otherwise specified.

PARAMETERS	XR-5534M/5534AM			XR-5534AC/XR-5534C			UNITS	SYMBOL	CONDITIONS
	MIN	TYP	MAX	MIN	TYP	MAX			
<b>DC CHARACTERISTICS</b>									
Input Offset Voltage		0.5	2 3		0.5	4 5	mV mV	$V_{OS}$	$T_A = 25^\circ\text{C}$ $T_T = \text{Full Range}^*$
Input Offset Current		10	200 500		20	300 400	nA nA	$I_{OS}$	$T_A = 25^\circ\text{C}$ $T_T = \text{Full Range}^*$
Input Bias Current		400	800 1500		500	1500 2000	nA nA	$I_B$	$T_A = 25^\circ\text{C}$ $T_T = \text{Full Range}^*$
Large Signal Voltage Gain	50 25	100		25 15	100		V/mV V/mV	$A_{VOL}$	$R_L \geq 600\Omega$ $V_O = \pm 10\text{V}$ $T_A = 25^\circ\text{C}$ $T_T = \text{Full Range}^*$
Supply Current		4	6.5		4	8	mA	$I_{CC}$	$R_L = \text{Open}$
Output Swing	$\pm 12$ $\pm 15$	$\pm 13$ $\pm 16$		$\pm 12$ $\pm 15$	$\pm 13$ $\pm 16$		V V	$V_{OUT}$	$R_L \geq 600\Omega$ $V_{CC} = V_{EE} = 15\text{V}$ $V_{CC} = V_{EE} = 18\text{V}$
Output Short Circuit Current		38			38		mA	$I_{SC}$	(Note 2)
Input Resistance	50	100		30	100		k $\Omega$	$R_{IN}$	
Common-Mode Range	$\pm 12$	$\pm 13$		$\pm 12$	$\pm 13$		V	$V_{ICM}$	
Common-Mode Rejection	80	100		70	100		dB	CMRR	
Power Supply Rejection		10	50		10	100	$\mu\text{V/V}$	PSRR	
<b>AC CHARACTERISTICS</b>									
Transient Response									Voltage Follower
Rise Time		20			20		nSec	$t_r$	$R_L \geq 600\Omega$ $C_C = 22\text{ pF}$
Overshoot		20			20		%	$t_0$	$C_L = 100\text{ pF}$
AC Gain		6 2.2			6 2.2		6 2.2 V/mV V/mV		$f = 10\text{ kHz}$ $C_C = 0$ $C_C = 22\text{ pF}$
Unity-Gain Bandwidth		10			10		MHz	BW	$C_C = 22\text{ pF}$ $C_L = 100\text{ pF}$
Slew Rate		13 6			13 6		V/ $\mu\text{sec}$ V/ $\mu\text{sec}$		$C_C = 0$ $C_C = 22\text{ pF}$
Power Bandwidth		95			95		kHz	$f_p$	$V_{OUT} = \pm 10\text{V}$ $C_C = 22\text{ pF}$ $C_C = 0$
		200			200		kHz		
<b>NOISE CHARACTERISTICS</b>									
PARAMETERS	XR-5534A			XR-5534			UNITS	SYMBOL	CONDITIONS
	MIN	TYP	MAX	MIN	TYP	MAX			
Input Noise Voltage		5.5 3.5	7 4.5		7 4		nV/ $\sqrt{\text{Hz}}$ nV/ $\sqrt{\text{Hz}}$	$e_n$	$f_0 = 30\text{ Hz}$ $f_0 = 1\text{ kHz}$
Input Noise Current		1.5 0.4			2.5 0.6		pA/ $\sqrt{\text{Hz}}$ pA/ $\sqrt{\text{Hz}}$	$i_n$	$f_0 = 30\text{ Hz}$ $f_0 = 1\text{ kHz}$
Broadband Noise Figure		0.9					dB	$F_N$	$R_S = 5\text{ k}\Omega$ $f = 10\text{ Hz to } 20\text{ kHz}$

\*These parameters, although guaranteed over the recommended operating conditions, are not 100% tested in production.

# XR-5534/5534A

TYPICAL PERFORMANCE CHARACTERISTICS (Continued)

INPUT NOISE CURRENT DENSITY

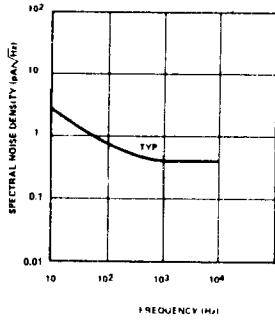

TOTAL INPUT NOISE DENSITY

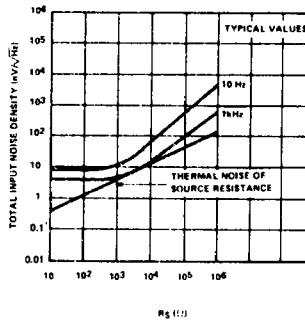

BROADBAND INPUT NOISE VOLTAGE

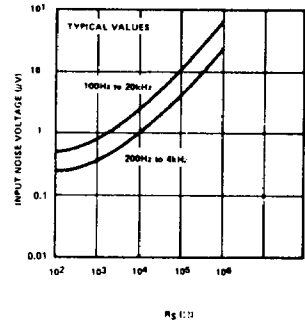

## TYPICAL APPLICATION

PREAMPLIFIER—RIAA/NAB COMPENSATION

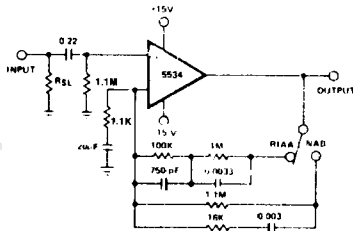

www.DataSheet4U.com

\*SELECT TO PROVIDE SPECIFIED TRANSDUCER LOADING.  
OUTPUT NOISE: 0.8 mV rms (WITH INPUT SHORTED).  
ALL RESISTOR VALUES ARE IN Ω/MS.

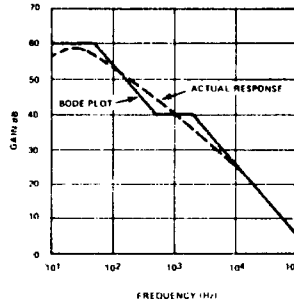

BODE PLOT OF RIAA EQUALIZATION AND THE RESPONSE REALIZED IN AN ACTUAL CIRCUIT USING THE XR-5534

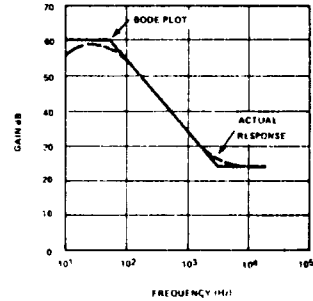

BODE PLOT OF NAB EQUALIZATION AND THE RESPONSE REALIZED IN THE ACTUAL CIRCUIT USING THE XR-5534

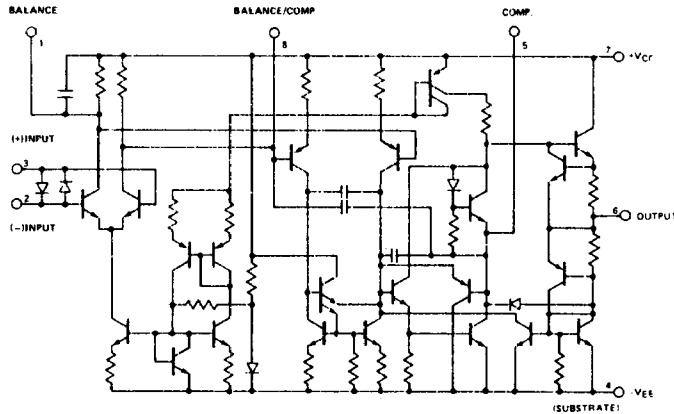

EQUIVALENT SCHEMATIC DIAGRAM

# XR-5534/5534A

## TEST CIRCUITS

### FREQUENCY COMPENSATION AND OFFSET VOLTAGE ADJUSTMENT CIRCUIT

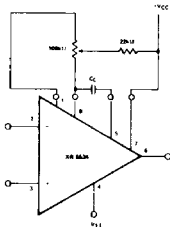

### CLOSED LOOP FREQUENCY RESPONSE

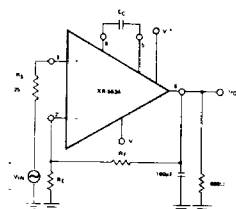

## TYPICAL PERFORMANCE CHARACTERISTICS

### OPEN LOOP FREQUENCY RESPONSE

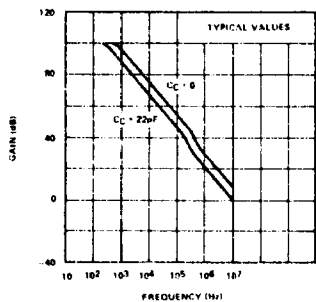

### SLEW-RATE AS A FUNCTION OF COMPENSATION CAPACITANCE

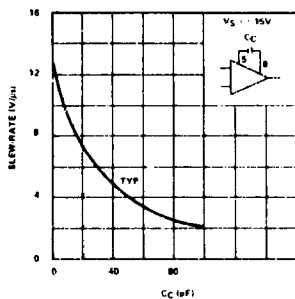

### CLOSED LOOP FREQUENCY RESPONSE

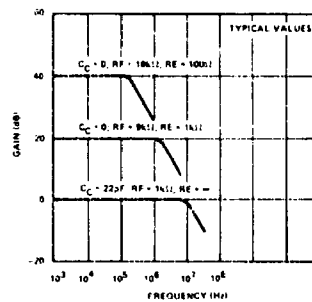

### LARGE-SIGNAL FREQUENCY RESPONSE

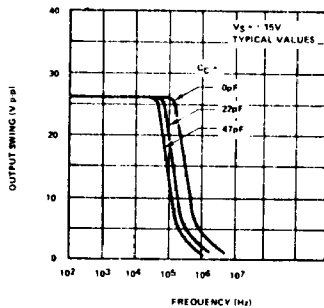

### OUTPUT SHORT-CIRCUIT CURRENT

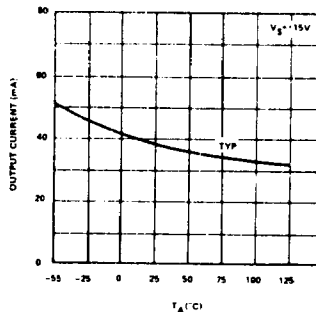

### INPUT BIAS CURRENT

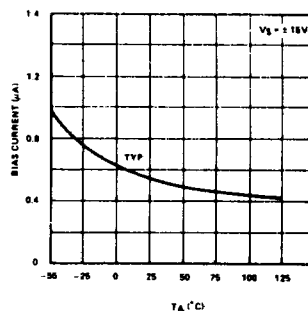

### INPUT COMMON MODE VOLTAGE RANGE

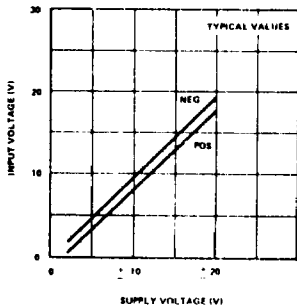

### SUPPLY CURRENT

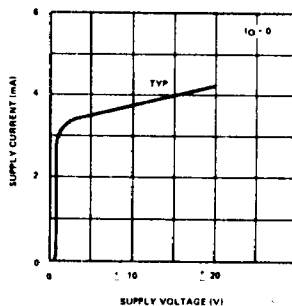

### INPUT NOISE VOLTAGE DENSITY

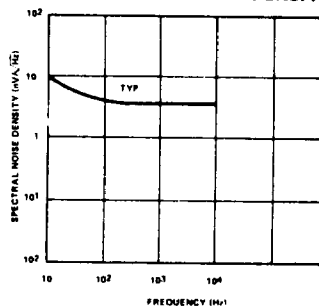

## Quad Line Driver/Receiver

### GENERAL DESCRIPTION

The XR-1488 is a monolithic quad line driver designed to interface data terminal equipment with data communications equipment in conformance with the specifications of EIA Standard No. RS232C. This extremely versatile integrated circuit can be used to perform a wide range of applications. Features such as output current limiting, independent positive and negative power supply driving elements, and compatibility with all DTL and TTL logic families greatly enhance the versatility of the circuit.

The XR-1489A is a monolithic quad line receiver designed to interface data terminal equipment with data communications equipment. The XR-1489A quad receiver along with its companion circuit, the XR-1488 quad driver, provide a complete interface system between DTL or TTL logic levels and the RS232C defined voltage and impedance levels.

### FUNCTIONAL BLOCK DIAGRAMS

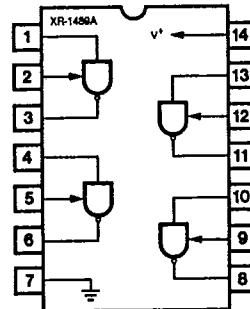
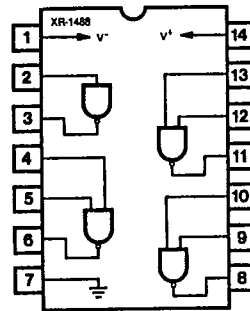

www.DataSheet4U.com

### ABSOLUTE MAXIMUM RATINGS

<b>Power Supply</b>	
XR-1488	± 15 Vdc
XR-1489A	+ 10 Vdc
<b>Power Dissipation</b>	
Ceramic Package	1000 mW
Derate above + 25°C	6.7 mW/°C
Plastic Package	650 mW/°C
Derate above + 25°C	5 mW/°C

### ORDERING INFORMATION

Part Number	Package	Operating Temperature
XR-1488N	Ceramic	0°C to +70°C
XR-1488P	Plastic	0°C to +70°C
XR-1489AN	Ceramic	0°C to +70°C
XR-1489AP	Plastic	0°C to +70°C

### SYSTEM DESCRIPTION

The XR-1488 and XR-1489A are a matched set of quad line drivers and line receivers designed for interfacing between TTL/DTL and RS232C data communication lines.

The XR-1488 contains four independent split supply line drivers, each with a ± 10 mA current limited output. For RS232C applications, the slew rate can be reduced to the 30 V/μS limit by shunting the output to ground with a 410 pF capacitor. The XR-1489A contains four independent line receivers, designed for interfacing RS232C to TTL/DTL. Each receiver features independently programmable switching thresholds with hysteresis, and input protection to ±30 V. The output can typically source 3 mA and sink 10 mA.

www.DataSheet4U.com