

19.0-26.0 GHz GaAs Receiver QFN, 7x7 mm

April 2006 - Rev 10-Apr-06

XR1005-QD
RoHS

Features

- ✕ Sub-harmonic Receiver
- ✕ Integrated LNA, LO Buffer, Image Reject Mixer
- ✕ 7x7 mm, QFN
- ✕ +2.0 dBm LO Drive Level
- ✕ 3.0 dB Noise Figure
- ✕ 20.0 dB Image Rejection
- ✕ 100% On-Wafer RF, DC and Noise Figure Testing

General Description

Mimix Broadband's 19.0-26.0 GHz GaAs packaged receiver has a noise figure of 3.0 dB and 20.0 dB image rejection across the band. This device is a two stage balanced LNA followed by an image reject sub-harmonic anti-parallel diode mixer and includes an integrated LO buffer amplifier. The image reject mixer eliminates the need for a bandpass filter after the LNA to remove thermal noise at the image frequency. The use of a sub-harmonic mixer makes the provision of the LO easier than for fundamental mixers at these frequencies. I and Q mixer outputs are provided and an external 90 degree hybrid is required to select the desired sideband. This device uses Mimix Broadband's 0.15 μm GaAs PHEMT device model technology, and is based upon electron beam lithography to ensure high repeatability and uniformity. The device comes in a 7x7 mm QFN Surface Mount Laminate Package offering excellent RF and thermal properties and is RoHS compliant. This device is well suited for Millimeter-wave Point-to-Point Radio, LMDS, SATCOM and VSAT applications.

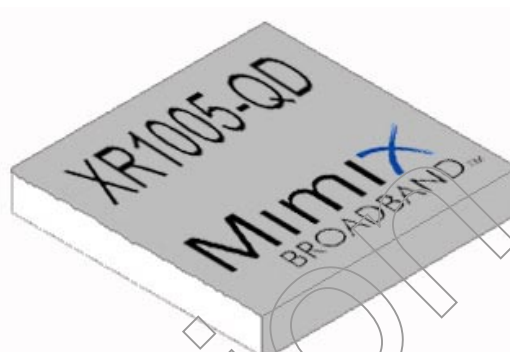

Absolute Maximum Ratings

Supply Voltage (Vd)	+4.5 VDC
Supply Current (Id1, Id2)	180, 165 mA
Gate Bias Voltage (Vg)	+0.3 VDC
Input Power (RF Pin)	0.0 dBm
Storage Temperature (Tstg)	-65 to +165 °C
Operating Temperature (Ta)	-55 to MTTF Table ³
Channel Temperature (Tch)	MTTF Table ³

(3) Channel temperature affects a device's MTTF. It is recommended to keep channel temperature as low as possible for maximum life.

Electrical Characteristics (Ambient Temperature T = 25° C)

Parameter	Units	Min.	Typ.	Max.
Frequency Range (RF) Upper Side Band	GHz	19.0	-	26.0
Frequency Range (RF) Lower Side Band	GHz	19.0	-	26.0
Frequency Range (LO)	GHz	8.0	-	14.5
Frequency Range (IF)	GHz	DC	-	3.0
Input Return Loss RF (S11)	dB	-	12.0	-
Small Signal Conversion Gain RF/IF (S21) ²	dB	-	8.0	-
LO Input Drive (P _{LO})	dBm	-	+2.0	-
Image Rejection ²	dBc	-	20.0	-
Noise Figure (NF) ²	dB	-	3.0	-
Isolation LO/RF @ LOx1/LOx2	dB	-	40.0	-
Input Third Order Intercept (IIP3) ^{1,2}	dBm	-	-7.0	-
Drain Bias Voltage (Vd1)	VDC	-	+4.0	+4.5
Drain Bias Voltage (Vd2)	VDC	-	+4.0	+4.5
Gate Bias Voltage (Vg1,2)	VDC	-1.2	-0.3	+0.1
Supply Current (Id1) (Vd1=4.0V, Vg=-0.3V Typical)	mA	-	130	155
Supply Current (Id2) (Vd2=4.0V, Vg=-0.3V Typical)	mA	-	116	140

(1) Measured using constant current.

(2) Measured using LO Input drive level of +2.0 dBm.

19.0-26.0 GHz GaAs Receiver QFN, 7x7 mm

Mimix
BROADBAND™

April 2006 - Rev 10-Apr-06

RI005-QD
RoHS

Receiver Measurements

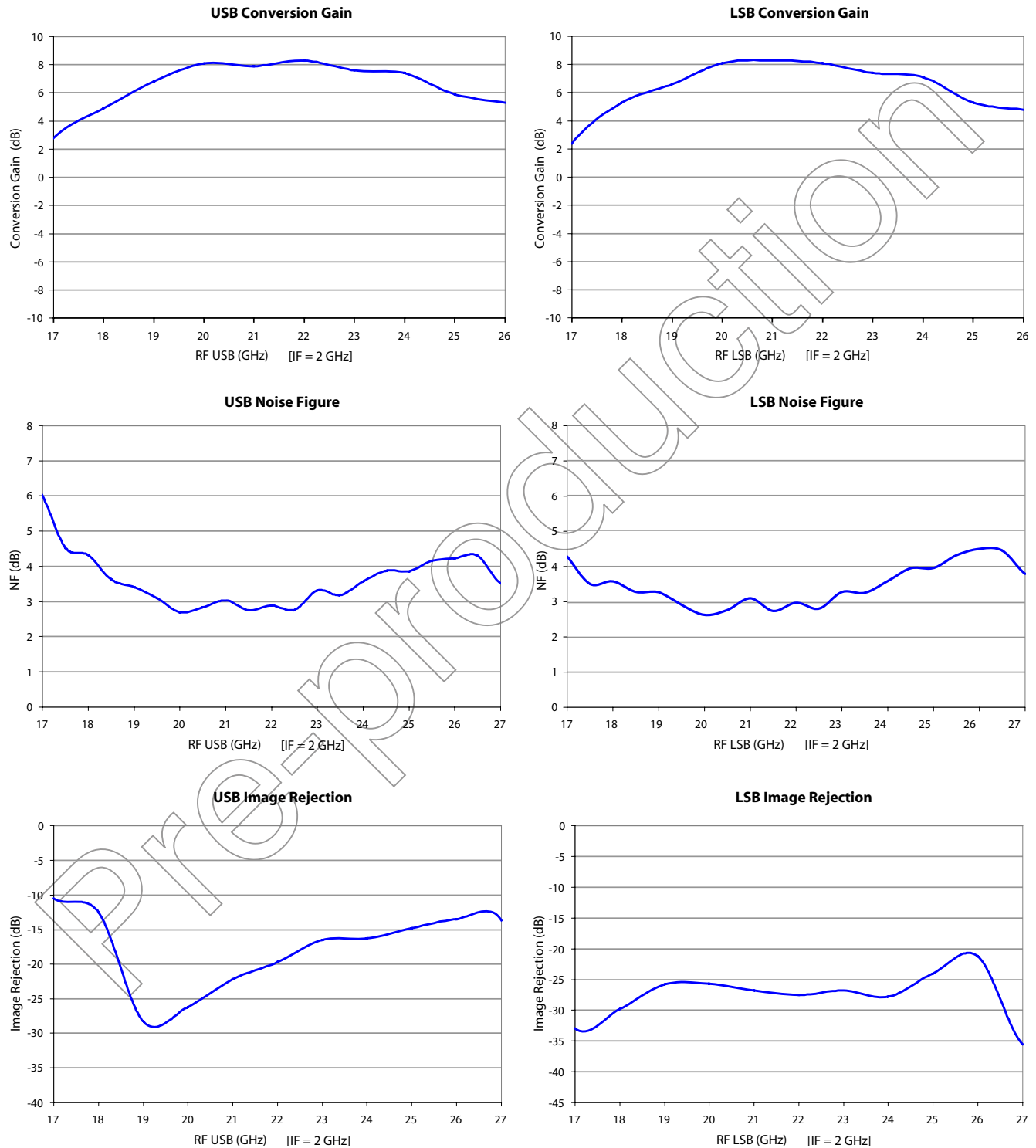

Mimix Broadband, Inc., 10795 Rockley Rd., Houston, Texas 77099
Tel: 281.988.4600 Fax: 281.988.4615 mimixbroadband.com

Page 2 of 7

Characteristic Data and Specifications are subject to change without notice. ©2006 Mimix Broadband, Inc.
Export of this item may require appropriate export licensing from the U.S. Government. In purchasing these parts, U.S. Domestic customers accept their obligation to be compliant with U.S. Export Laws.

19.0-26.0 GHz GaAs Receiver QFN, 7x7 mm

April 2006 - Rev 10-Apr-06

Receiver Measurements (cont.)

Typical OIP3 and IIP3 at USB, LO Pin = -2, 0 and +2dBm

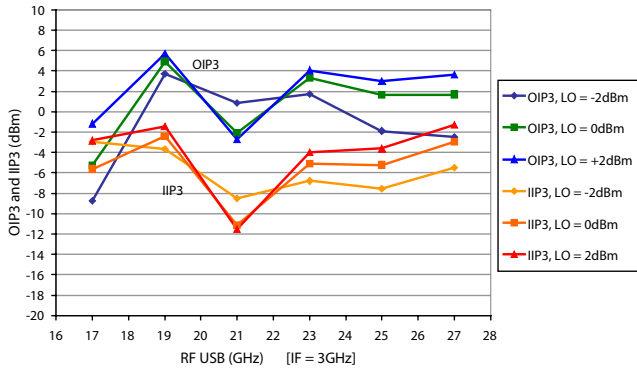

* Measured on-wafer prior to packaging

Typical OIP3 and IIP3 at LSB, LO Pin = -2, 0 and +2dBm

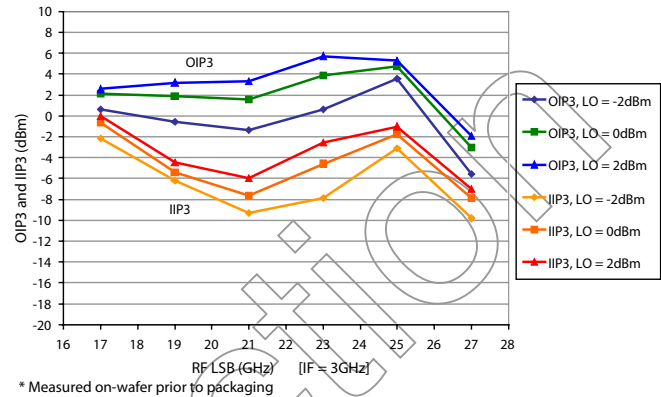

* Measured on-wafer prior to packaging

Pre-production

19.0-26.0 GHz GaAs Receiver

QFN, 7x7 mm

April 2006 - Rev 10-Apr-06

RI005-QD
RoHS

Package Outline

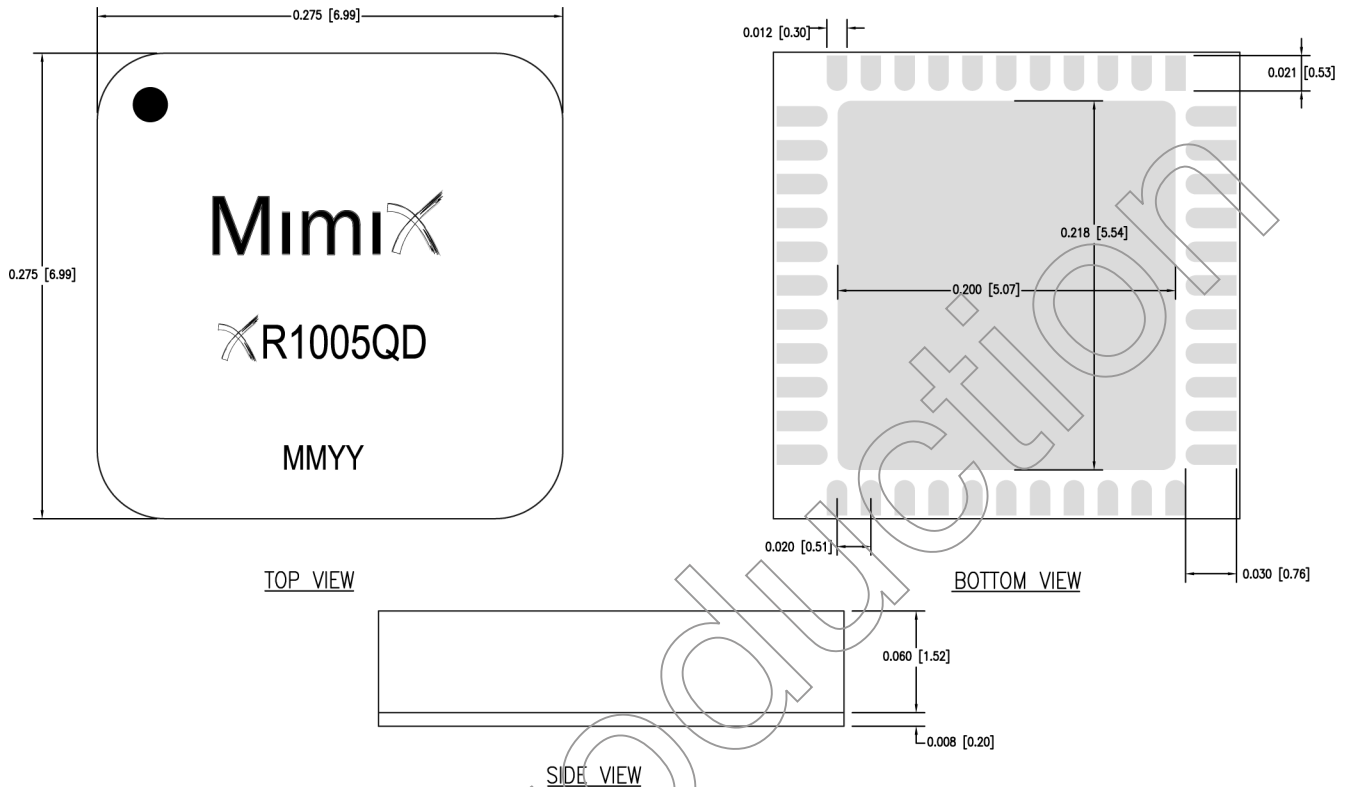

Pin Designations

(Note: Engineering designator is 22REC0393)

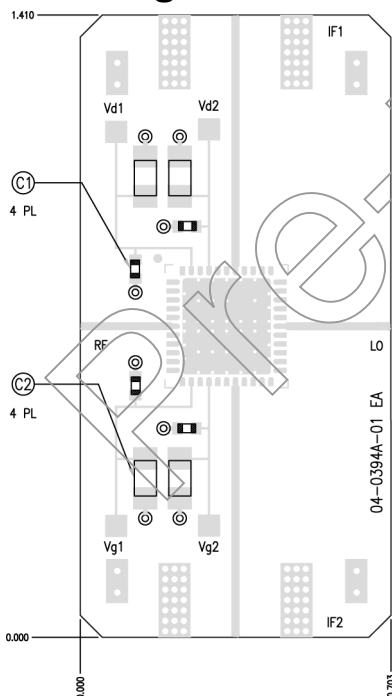

Pin Number	Pin Name	Pin Function	Nominal Value	Unit
6	RF in	RF input		
13	VG1	LNA Gate Bias	-0.3	V
15	VG2	LO Buffer Gate Bias	-0.1	V
18	IF2	IF2 output		
28	LO in	LO input		
38	IF1	IF1 output		
41	VD2	LO Buffer Drain Bias	4.0	V
43	VD1	LNA Drain Bias	3.5	V

All other pins N/C

NOTE:
C1: CAP, 10nF, 0402 SIZE, 10%, 16V
C2: CAP, 1uF, 0805 SIZE, 10%, 16V
U1: XR1005QD, 7X7 QFN, 44L

19.0-26.0 GHz GaAs Receiver QFN, 7x7 mm

April 2006 - Rev 10-Apr-06

App Note [1] Biasing - The device is operated by separately biasing Vd1 and Vd2 with Vd1=4.0V, Id1=130mA and Vd2=4.0V, Id2=116mA. It is also recommended to use active biasing to keep the currents constant as the RF power and temperature vary; this gives the most reproducible results. Depending on the supply voltage available and the power dissipation constraints, the bias circuit may be a single transistor or a low power operational amplifier, with a low value resistor in series with the drain supply used to sense the current. The gate of the pHEMT is controlled to maintain correct drain current and thus drain voltage. The typical gate voltage needed to do this is -0.3V. Typically the gate is protected with Silicon diodes to limit the applied voltage. Also, make sure to sequence the applied voltage to ensure negative gate bias is available before applying the positive drain supply.

MTTF Table (TBD)

These numbers were calculated based on accelerated life test information and thermal model analysis received from the fabricating foundry.

Backplate Temperature	Channel Temperature	Rth	MTTF Hours	FITs
55 deg Celsius	deg Celsius	C/W	E+	E+
75 deg Celsius	deg Celsius	C/W	E+	E+
95 deg Celsius	deg Celsius	C/W	E+	E+

Bias Conditions: Vd1=4.0V, Vd2=4.0V, Id1=130 mA, Id2=116 mA

Typical Application

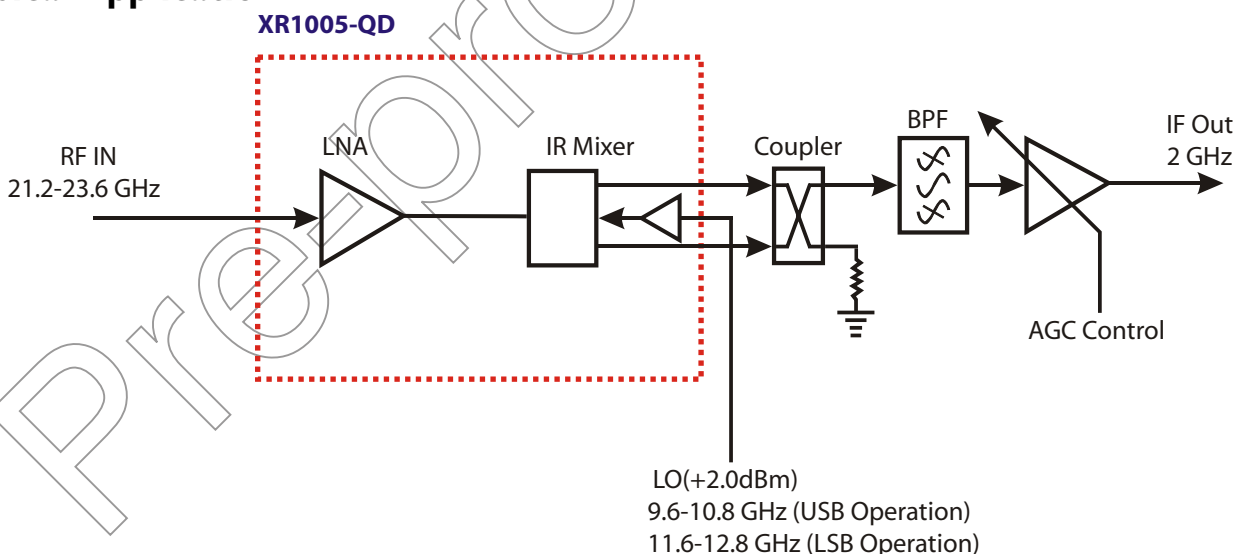

Mimix Broadband MMIC-based 19.0-26.0 GHz Receiver Block Diagram

(Changing LO and IF frequencies as required allows design to operate as high as 26.0 GHz)

Mimix Broadband's 19.0-26.0 GHz XR1005-QD GaAs Receiver can be used in saturated radio applications and linear modulation schemes up to 16 QAM. The receiver can be used in upper and lower sideband applications from 19.0-26.0 GHz.

19.0-26.0 GHz GaAs Receiver QFN, 7x7 mm

App Note [3] USB/LSB Selection -

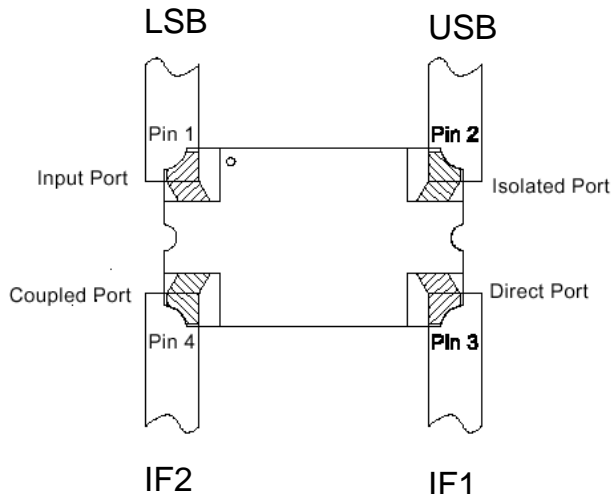

For Upper Side Band operation (USB):

With IF1 and IF2 connected to the direct port (0°) and coupled port (90°) respectively as shown in the diagram, the USB signal will reside on the isolated port. The input port must be loaded with 50 ohms.

For Lower Side Band operation (LSB):

With IF1 and IF2 connected to the direct port (0°) and coupled port (90°) respectively as shown in the diagram, the LSB signal will reside on the input port. The isolated port must be loaded with 50 ohms.

An alternate method of Selection of USB or LSB:

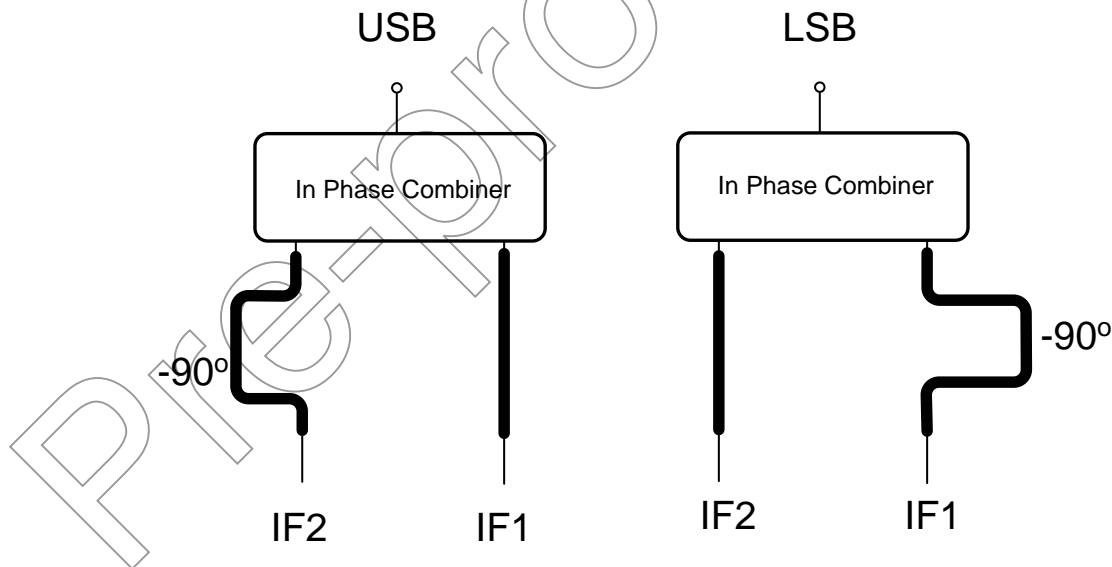

I9.0-26.0 GHz GaAs Receiver QFN, 7x7 mm

April 2006 - Rev 10-Apr-06

Handling and Assembly Information

CAUTION! - Mimix Broadband MMIC Products contain gallium arsenide (GaAs) which can be hazardous to the human body and the environment. For safety, observe the following procedures:

- Do not ingest.
- Do not alter the form of this product into a gas, powder, or liquid through burning, crushing, or chemical processing as these by-products are dangerous to the human body if inhaled, ingested, or swallowed.
- Observe government laws and company regulations when discarding this product. This product must be discarded in accordance with methods specified by applicable hazardous waste procedures.

Life Support Policy - Mimix Broadband's products are not authorized for use as critical components in life support devices or systems without the express written approval of the President and General Counsel of Mimix Broadband. As used herein: (1) Life support devices or systems are devices or systems which, (a) are intended for surgical implant into the body, or (b) support or sustain life, and whose failure to perform when properly used in accordance with instructions for use provided in the labeling, can be reasonably expected to result in a significant injury to the user. (2) A critical component is any component of a life support device or system whose failure to perform can be reasonably expected to cause the failure of the life support device or system, or to affect its safety or effectiveness.

Package Attachment - This packaged product from Mimix Broadband is provided as a rugged surface mount package compatible with high volume solder installation. The package is a low-cost plastic package. Vacuum tools or other suitable pick and place equipment may be used to pick and place this part. Care should be taken to ensure that there are no voids or gaps in the solder connection so that good RF, DC and ground connections are maintained. Voids or gaps can eventually lead not only to RF performance degradation, but reduced reliability and life of the product due to thermal stress.

Typical Reflow Profiles

Reflow Profile	SnPb	Pb Free
Ramp Up Rate	3-4 °C/sec	3-4 °C/sec
Activation Time and Temperature	60-120 sec @ 140-160 °C	60-180 sec @ 170-200 °C
Time Above Melting Point	60-150 sec	60-150 sec
Max Peak Temperature	240 °C	265 °C
Time Within 5 °C of Peak	10-20 sec	10-20 sec
Ramp Down Rate	4-6 °C/sec	4-6 °C/sec

Mimix Lead-Free RoHS Compliant Program - Mimix has an active program in place to meet customer and governmental requirements for eliminating lead (Pb) and other environmentally hazardous materials from our products. All Mimix RoHS compliant components are form, fit and functional replacements for their non-RoHS equivalents. Lead plating of our RoHS compliant parts is 100% matt tin (Sn) over copper alloy and is backwards compatible with current standard SnPb low-temperature reflow processes as well as higher temperature (260°C reflow) "Pb Free" processes.

Part Number for Ordering Description

XR1005-QD-0N00	Ni/Au plated RoHS compliant QFN 7x7 44L surface mount package in bulk quantity
XR1005-QD-0N0T	Ni/Au plated RoHS compliant QFN 7x7 44L surface mount package in tape and reel
XR1005-QD-EV1	XR1005-QD Evaluation Module

We also offer this part with alternative plating options. Please contact your regional sales manager for more information regarding different plating types.