

4.5-10.5 GHz GaAs MMIC Receiver

Features

- ✕ Integrated LNA, Mixer and LO Buffer Amp
- ✕ 1.6 dB Noise Figure
- ✕ 14.0 dB Conversion Gain
- ✕ BCB Coated Die
- ✕ 100% RF, DC and NF Testing
- ✕ 100% Commercial-Level Visual Inspection Using Mil-Std-883 Method 2010

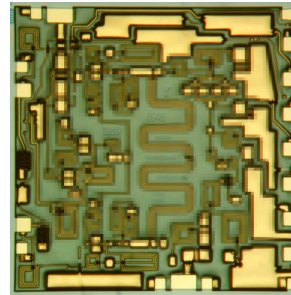

General Description

Mimix Broadband's 4.5-10.5 GHz receiver has a noise figure of 1.6 dB and 14.0 dB conversion gain across the band. The device integrates an LNA, image reject mixer and LO buffer amplifier within a single, compact MMIC. The image reject mixer eliminates the need for a bandpass filter after the LNA to remove thermal noise at the image frequency. I and Q mixer outputs are provided and an external 90 degree hybrid is required to select the desired sideband. This device uses Mimix Broadband's GaAs PHEMT device model technology, and is based upon electron beam lithography to ensure high repeatability and uniformity. This device is well suited for Point-to-Point Radio, LMDS, SATCOM and VSAT applications.

Absolute Maximum Ratings¹

| | |
|-------------------------------|----------------|
| Supply Voltage (Vdd) | +4.3 VDC |
| Supply Current (Idd) | 180 mA |
| Gate Voltage (Vgg) | -3 V |
| Max Power Dissipation (Pdiss) | 750 mW |
| RF Input Power (Pin) | +14 dBm |
| LO Input Power (Pin) | +15 dBm |
| Operating Temperature (Ta) | -55 to +85 °C |
| Storage Temperature (Tstg) | -65 to +165 °C |
| Channel Temperature (Tch) | 175 °C |

(1) Operation of this device above any one of these parameters may cause permanent damage

(2) Channel temperature directly affects a device's MTTF. Channel temperature should be kept as low as possible to maximize lifetime

Electrical Characteristics (Ambient Temperature T = 25 °C)

| Parameter | Units | Min. | Typ. | Max. |
|--|-------|-------------------|------|------------------|
| Frequency Range (RF/LO) | GHz | 4.5 | - | 10.5 |
| Frequency Range (IF) | GHz | DC | - | 3.5 |
| Conversion Gain (CG) | dB | 12.0 ⁵ | 14.0 | |
| Noise Figure (NF) | dB | | 1.6 | 2.0 ⁵ |
| Input Third Order Intercept (IIP3) | dBm | | 2.0 | |
| Image Rejection | dBc | 13.0 ⁵ | 20.0 | |
| LO Input Drive | dBm | | 5.0 | |
| LO/RF Isolation | dB | | 50.0 | |
| RF Input Return Loss | dB | | 10.0 | |
| LO Input Return Loss | dB | | 10.0 | |
| IF Input Return Loss | dB | | 10.0 | |
| Drain Bias Voltage (Vd1,2,3) | VDC | | 4.0 | 4.0 |
| Gate Bias Voltage (Vg1,2,3) ³ | VDC | -1.2 | -0.3 | 0.2 |
| Gate Bias Voltage (Vg4) ⁴ | VDC | | -2.0 | |
| Supply Current (Id1) | mA | | 25.0 | |
| Supply Current (Id2) | mA | | 45.0 | |
| Supply Current (Id3) | mA | | 60.0 | |
| Supply Current (Ig4) | mA | | 2.0 | |

(3) Vg1,2 and 3 are adjusted to achieve constant drain current regulation.

(4) Vg4 provides mixer bias and is fixed at -2.0V.

(5) 100% RF tested at 6.5-8.5 GHz.

4.5-10.5 GHz GaAs MMIC Receiver

September 2009 - Rev 11-Sep-09

Receiver Measurements

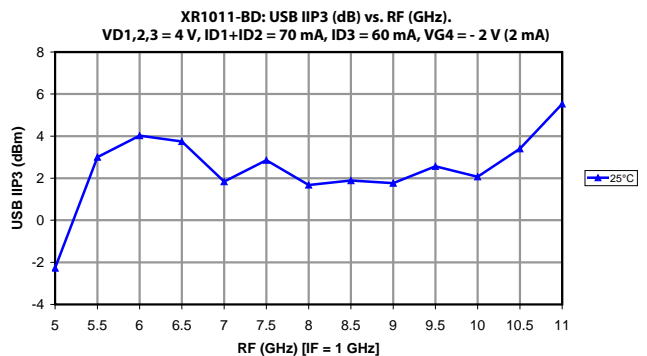
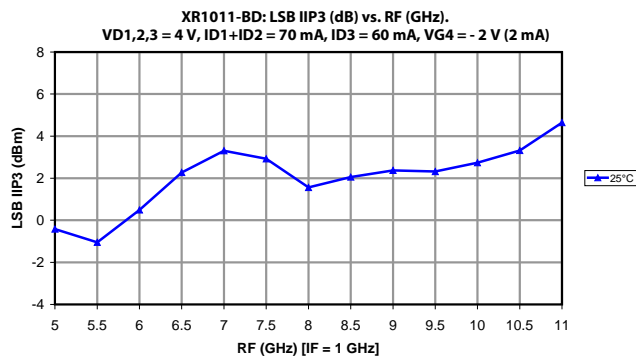
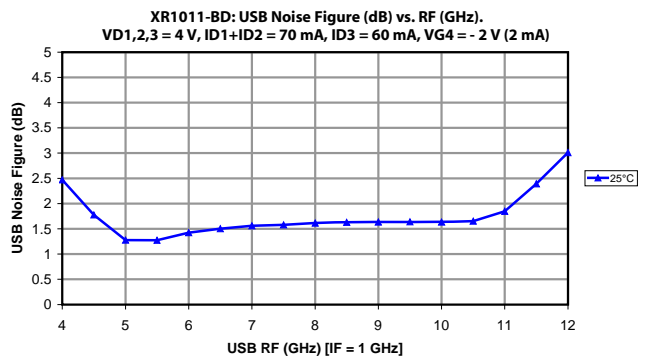
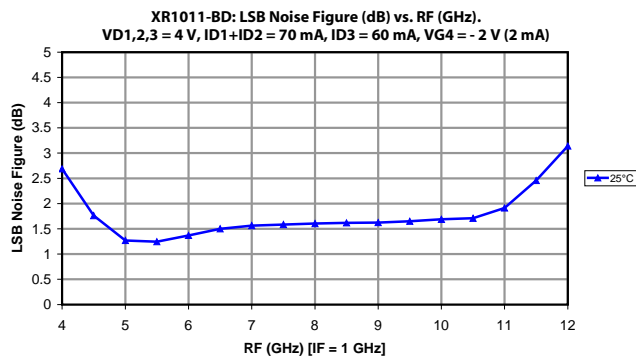
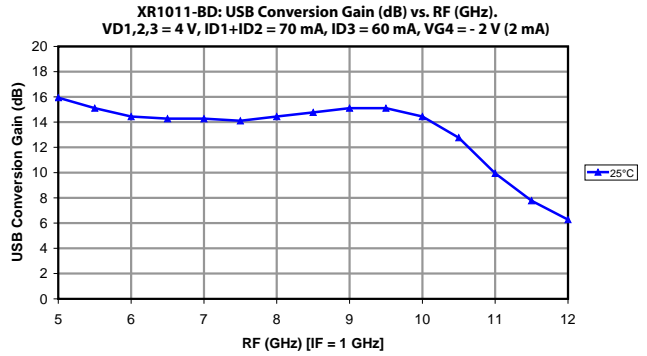
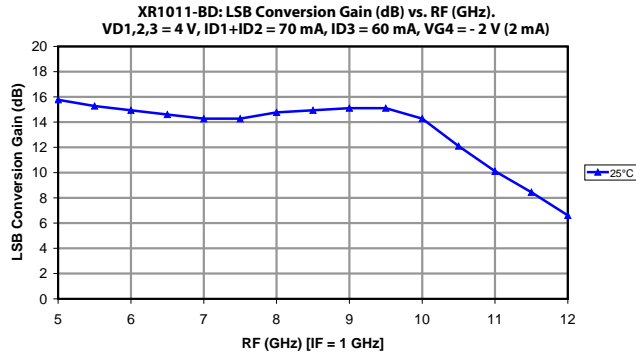

4.5-10.5 GHz GaAs MMIC Receiver

September 2009 - Rev 11-Sep-09

Receiver Measurements (cont.)

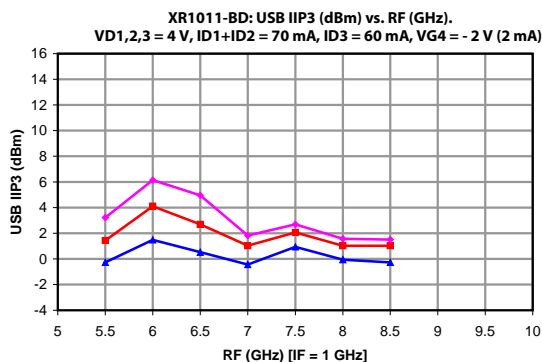
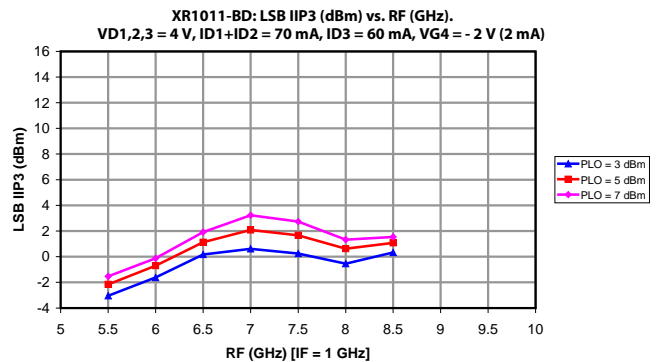
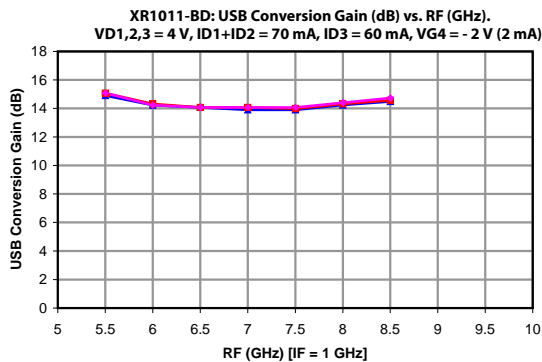
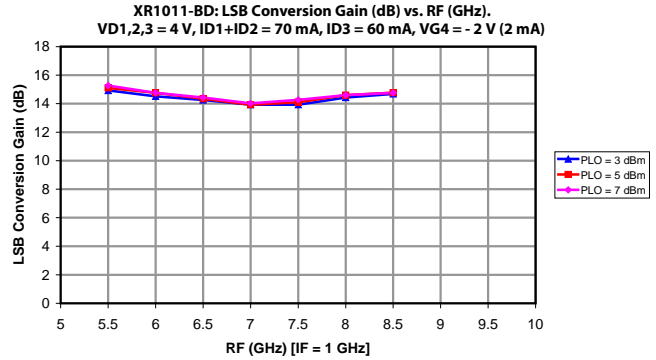
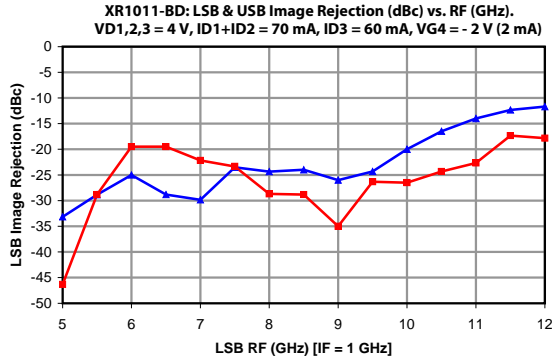

4.5-10.5 GHz GaAs MMIC Receiver

App Note [1] Biasing - The device is operated by biasing VD1,2,3 at 4.0V with 25, 45, 60mA respectively. Additionally, a fixed voltage bias of -2V is required for mixer bias. It is recommended to use active bias to keep the currents constant in order to maintain the best performance over temperature. Depending on the supply voltage available and the power dissipation constraints, the bias circuit may be a single transistor or a low power operational amplifier, with a low value resistor in series with the drain supply used to sense the current. The gate of the pHEMT is controlled to maintain correct drain current and thus drain voltage. The typical gate voltage needed to do this is -0.3V. Make sure to sequence the applied voltage to ensure negative gate bias is available before applying the positive drain supply.

App Note [2] Board Layout - It is recommended to provide 100pF decoupling caps as close to the bias pads as possible, with additional 10µF decoupling caps.

Functional Schematic

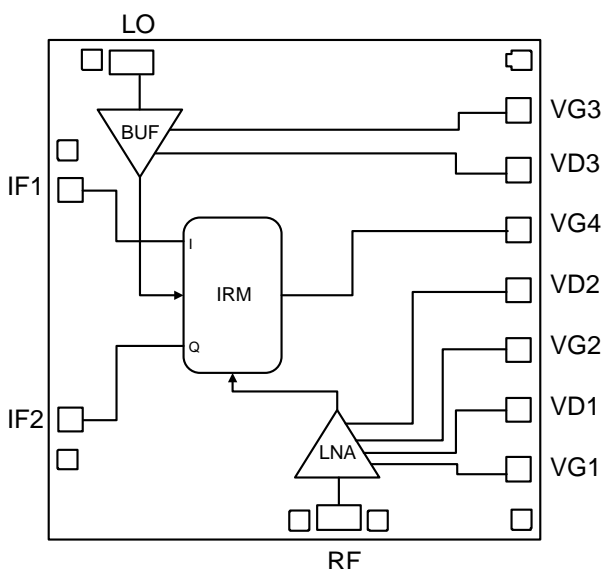

Pad Designation

| Pad Number | Pin Name | Pin Function | Nominal Value |
|------------|----------|--------------|---|
| 1 | IF2 | IF2 Output | To Hybrid 90° (LSB) To Hybrid 0° (USB) |
| 2 | IF1 | IF1 Output | To Hybrid 90° (LSB) To Hybrid 0° (USB) |
| 3 | LO | LO Input | +5.0 dBm |
| 4 | VG3 | Gate 3 Bias | -0.3V |
| 5 | VD3 | Drain 3 Bias | 4.0V, 60 mA |
| 6 | VG4 | Gate 4 Bias | -2.0V, 2 mA |
| 7 | VD2 | Drain 2 Bias | 4.0V, 45 mA |
| 8 | VG2 | Gate 2 Bias | -0.3V |
| 9 | VD1 | Drain 1 Bias | 4.0V, 25 mA |
| 10 | VG1 | Gate 1 Bias | -0.3V |
| 11 | RF | RF Input | |

Mechanical Dimensions

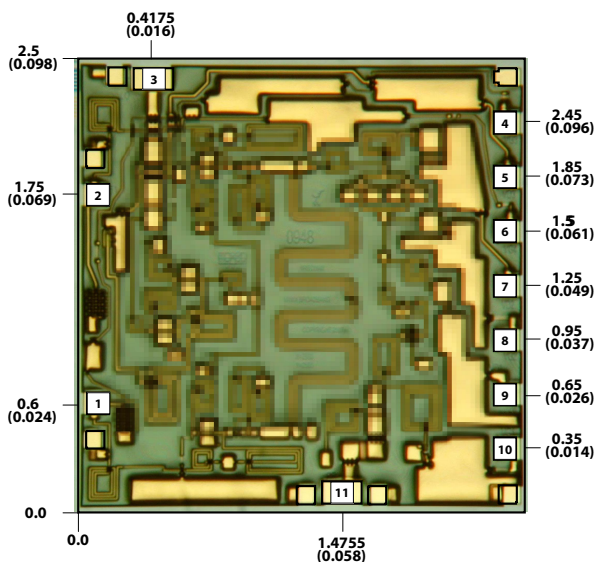

4.5-10.5 GHz GaAs MMIC Receiver

September 2009 - Rev 11-Sep-09

Handling and Assembly Information

CAUTION! - Mimix Broadband MMIC Products contain gallium arsenide (GaAs) which can be hazardous to the human body and the environment. For safety, observe the following procedures:

- Do not ingest.
- Do not alter the form of this product into a gas, powder, or liquid through burning, crushing, or chemical processing as these by-products are dangerous to the human body if inhaled, ingested, or swallowed.
- Observe government laws and company regulations when discarding this product. This product must be discarded in accordance with methods specified by applicable hazardous waste procedures.

Life Support Policy - Mimix Broadband's products are not authorized for use as critical components in life support devices or systems without the express written approval of the President and General Counsel of Mimix Broadband. As used herein: (1) Life support devices or systems are devices or systems which, (a) are intended for surgical implant into the body, or (b) support or sustain life, and whose failure to perform when properly used in accordance with instructions for use provided in the labeling, can be reasonably expected to result in a significant injury to the user. (2) A critical component is any component of a life support device or system whose failure to perform can be reasonably expected to cause the failure of the life support device or system, or to affect its safety or effectiveness.

ESD - Gallium Arsenide (GaAs) devices are susceptible to electrostatic and mechanical damage. Die are supplied in antistatic containers, which should be opened in cleanroom conditions at an appropriately grounded anti-static workstation. Devices need careful handling using correctly designed collets, vacuum pickups or, with care, sharp tweezers.

Die Attachment - GaAs Products from Mimix Broadband are 0.100 mm (0.004") thick and have vias through to the backside to enable grounding to the circuit. Microstrip substrates should be brought as close to the die as possible. The mounting surface should be clean and flat. If using conductive epoxy, recommended epoxies are Tanaka TS3332LD, Die Mat DM6030HK or DM6030HK-Pt cured in a nitrogen atmosphere per manufacturer's cure schedule. Apply epoxy sparingly to avoid getting any on to the top surface of the die. An epoxy fillet should be visible around the total die periphery. For additional information please see the Mimix "Epoxy Specifications for Bare Die" application note. If eutectic mounting is preferred, then a fluxless gold-tin (AuSn) preform, approximately 0.001" thick, placed between the die and the attachment surface should be used. A die bonder that utilizes a heated collet and provides scrubbing action to ensure total wetting to prevent void formation in a nitrogen atmosphere is recommended. The gold-tin eutectic (80% Au 20% Sn) has a melting point of approximately 280° C (Note: Gold Germanium should be avoided). The work station temperature should be 310° C +/- 10° C. Exposure to these extreme temperatures should be kept to minimum. The collet should be heated, and the die pre-heated to avoid excessive thermal shock. Avoidance of air bridges and force impact are critical during placement.

Wire Bonding - Windows in the surface passivation above the bond pads are provided to allow wire bonding to the die's gold bond pads. The recommended wire bonding procedure uses 0.076 mm x 0.013 mm (0.003" x 0.0005") 99.99% pure gold ribbon with 0.5-2% elongation to minimize RF port bond inductance. Gold 0.025 mm (0.001") diameter wedge or ball bonds are acceptable for DC Bias connections. Aluminum wire should be avoided. Thermo-compression bonding is recommended though thermosonic bonding may be used providing the ultrasonic content of the bond is minimized. Bond force, time and ultrasonics are all critical parameters. Bonds should be made from the bond pads on the die to the package or substrate. All bonds should be as short as possible.

Ordering Information

| Part Number for Ordering | Description |
|--------------------------|-------------------------------|
| XR1011-BD-000V | "V" - vacuum release gel paks |
| XR1011-BD-EV1 | XR1011 die evaluation module |



Proper ESD procedures should be followed when handling this device.

Mimix Broadband, Inc., 10795 Rockley Rd., Houston, Texas 77099
Tel: 281.988.4600 Fax: 281.988.4615 mimixbroadband.com

Page 5 of 5