



General Description

The XR76115 is a synchronous step-down regulator combining the controller, drivers, bootstrap diode and MOSFETs in a single package for point-of-load supplies. The XR76115 has a load current rating of 15A. A wide 5V to 22V input voltage range allows for single supply operation from industry standard 5V, 12V and 19.6V rails.

With a proprietary emulated current mode Constant On-Time (COT) control scheme, the XR76115 provides extremely fast line and load transient response using ceramic output capacitors. It requires no loop compensation, simplifying circuit implementation and reducing overall component count. The control loop also provides 0.25% load and 0.12% line regulation and maintains constant operating frequency. A selectable power saving mode, allows the user to operate in discontinuous mode (DCM) at light current loads thereby significantly increasing the converter efficiency.

A host of protection features, including over-current, over-temperature, short-circuit and UVLO, help achieve safe operation under abnormal operating conditions.

The XR76115 is available in a RoHS-compliant, green/halogen-free space-saving QFN 6x6mm package.

FEATURES

- 15A Capable Step Down Regulator
 - 4.5V to 5.5V Low V_{IN} Operation
 - 5V to 22V Wide Single Input Voltage
 - $\geq 0.6V$ Adjustable Output Voltage
- Controller, drivers, bootstrap diode and MOSFETs integrated in one package
- Proprietary Constant On-Time Control
 - No Loop Compensation Required
 - Ceramic Output Cap. Stable operation
 - Programmable 200ns-2 μ s On-Time
 - Quasi Constant 200kHz-800kHz Freq.
 - Selectable CCM or CCM/DCM Operation
- Precision Enable and Power-Good Flag
- Programmable Soft-start
- 6x6mm 37-pin QFN Package

APPLICATIONS

- Distributed Power Architecture
- Point-of-Load Converters
- Power Supply Modules
- FPGA, DSP, and Processor Supplies
- Base Stations, Switches/Routers, and Servers

Typical Application

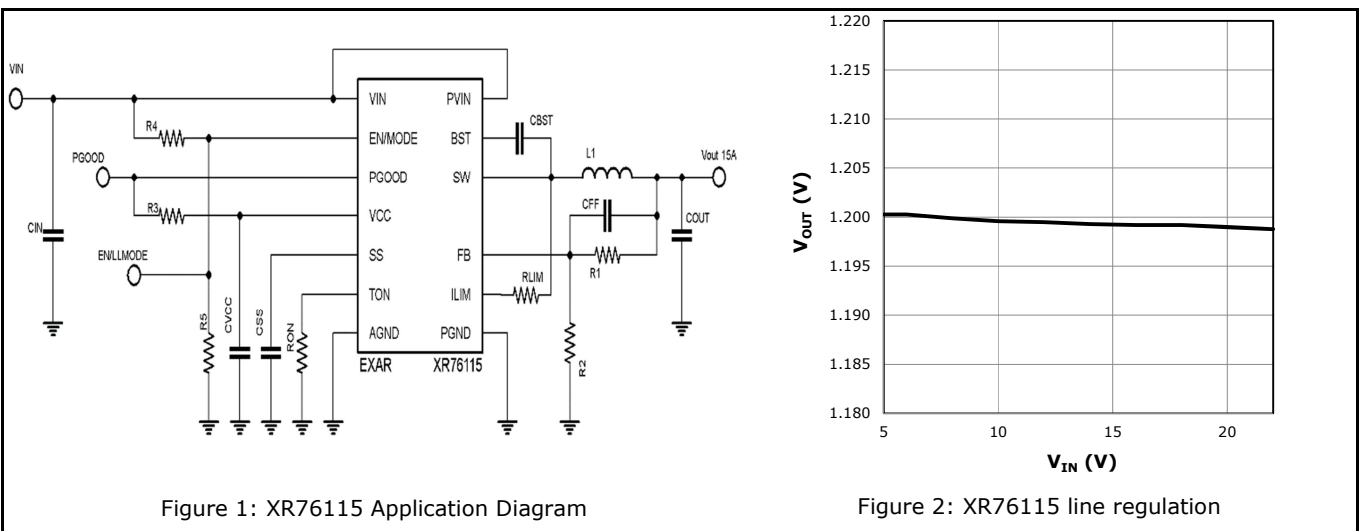

Absolute Maximum Ratings

These are stress ratings only and functional operation of the device at these ratings or any other above those indicated in the operation sections of the specifications below is not implied. Stresses beyond those listed under Absolute Maximum Ratings may cause permanent damage to the device. Exposure to any Absolute Maximum Rating condition for extended periods may affect device reliability and lifetime.

PV_{IN}, V_{IN} -0.3V to 25V
 V_{CC} -0.3V to 6.0V
 BST -0.3V to 31V¹
 BST-SW -0.3V to 6V
 SW, I_{LIM} -1V to 25V^{1,2}
 All other pins -0.3V to V_{CC}+0.3V
 Storage Temperature -65°C to 150°C
 Junction Temperature 150°C
 Power Dissipation Internally Limited
 Lead Temperature (Soldering, 10 sec) 300°C
 ESD Rating (HBM - Human Body Model) 2kV

Operating Ratings

PV_{IN} 3V to 22V
 V_{IN} 4.5V to 22V
 V_{CC} 4.5V to 5.5V
 SW, I_{LIM} -1V to 22V²
 PGOOD, V_{CC}, T_{ON}, SS, EN -0.3V to 5.5V
 Switching Frequency 200kHz-800kHz³
 Junction Temperature Range (T_J) -40°C to 125°C
 XR76115 Package Power Dissipation max at 25°C 5.2W
 XR76115 JEDEC51 Package Thermal Resistance θ_{JA} 19°C/W

- Note 1: No external voltage applied
 Note 2: SW pin's DC range is -1V, transient is -5V for less than 50ns
 Note 3: Recommended

Ordering Information

Part Number	Temperature Range	Marking	Package	Packing Quantity	Note 1
XR76115EL-F	-40°C ≤ T _J ≤ +125°C	76115EL YYWW XXXXXXX	6x6mm QFN	Bulk	RoHS Compliant Halogen Free
XR76115ELMTR-F				250/Tape & Reel	
XR76115ELTR-F				3k/Tape & Reel	
XR76115EVB	XR76115 Evaluation Board				

“YY” = Year - “WW” = Work Week - “XXXXXXX” = Lot Number; when applicable.

Electrical Characteristics

Specifications are for Operating Junction Temperature of T_J = 25°C only; limits applying over the full Operating Junction Temperature range are denoted by a “*”. Typical values represent the most likely parametric norm at T_J = 25°C, and are provided for reference purposes only. Unless otherwise indicated, V_{IN}=12V

Parameter	Min.	Typ.	Max.	Units	Conditions
Power Supply Characteristics					
V _{IN} , Input Voltage Range	5 4.5	12 5.0	22 5.5	V	• V _{CC} regulating • V _{CC} tied to V _{IN}
I _{VIN} , V _{IN} supply current		0.7	1.3	mA	• Not switching, V _{IN} =12V, V _{FB} =0.7V
I _{VCC} , V _{CC} Quiescent current		0.7	1.3	mA	• Not switching, V _{CC} =V _{IN} =5V, V _{FB} =0.7V
I _{VIN} , V _{IN} supply current		11		mA	f=300kHz, R _{ON} =107k, V _{FB} =0.58V
I _{OFF} , Shutdown current		0.5		µA	Enable=0V, V _{IN} =12V, V _{IN} =PV _{IN}
Enable and Under-Voltage Lock-Out UVLO					
V _{IH_EN} , EN Pin Rising Threshold	1.8	1.9	2.0	V	•
V _{EN_HYS} , EN Pin Hysteresis		50		mV	
V _{IH_EN} , EN Pin Rising Threshold for DCM/CCM operation	2.8	3.0	3.1	V	•
V _{EN_HYS} , EN Pin Hysteresis		100		mV	
V _{CC} UVLO start threshold, rising edge	4.00	4.25	4.50	V	•
V _{CC} UVLO Hysteresis		200		mV	

Parameter	Min.	Typ.	Max.	Units	Conditions
Reference voltage					
V _{REF} , Reference voltage	0.597	0.600	0.603	V	V _{IN} =5V-22V → V _{CC} regulating
	0.596	0.600	0.604	V	V _{IN} =4.5V-5.5V → V _{CC} tied to V _{IN}
	0.594	0.600	0.606	V	• V _{IN} =5V-22V → V _{CC} regulating, V _{IN} =4.5V-5.5V → V _{CC} tied to V _{IN}
DC load regulation		±0.25		%	CCM operation, closed loop, applies to any C _{OUT}
DC Line regulation		±0.12		%	
Parameter	Min.	Typ.	Max.	Units	Conditions
Programmable Constant On-Time					
On-Time 1	1.66	1.95	2.24	µs	• R _{ON} =140kΩ, V _{IN} =22V
f corresponding to On-Time 1	243	280	329	kHz	V _{IN} =22V, V _{OUT} =12V
Minimum Programmable On-Time		109		ns	R _{ON} =6.98kΩ, V _{IN} =22V
On-Time 2	170	200	230	ns	• R _{ON} =6.98kΩ, V _{IN} =12V
f corresponding to On-Time 2	362	417	490	kHz	V _{OUT} =1.0V
On-Time 3	365	430	495	ns	• R _{ON} =16.2kΩ, V _{IN} =12V
Minimum Off-Time		250	350	ns	•
Diode Emulation Mode					
Zero crossing threshold		-2		mV	DC value measured during test
Soft-Start					
SS Charge current	-14	-10	-6	µA	•
SS Discharge current	1	3		mA	• Fault present
V_{CC} Linear Regulator					
V _{CC} Output Voltage	4.8	5.0	5.2	V	• V _{IN} =6V to 22V, I _{load} =0 to 30mA
	4.51	4.7			• V _{IN} =5V, I _{load} =0 to 20mA
Dropout Voltage	100	300	490	mV	• I _{VCC} =30mA
Power Good Output					
Power Good Threshold	-10	-7.5	-5	%	
Power Good Hysteresis		2	4	%	
Power Good Sink Current	1	15		mA	
Protection: OCP, OTP, Short-Circuit					
Hiccup timeout		110		ms	
I _{LIM} pin source current	45	50	55	µA	
I _{LIM} current temperature coefficient		0.4		%/°C	
I _{LIM} comparator offset	-8	0	+8	mV	•
Current limit blanking		100		ns	
Thermal shutdown threshold		150		°C	Rising temperature
Thermal Hysteresis		15		°C	
Feedback pin short-circuit threshold	50	60	70	%	• Percent of V _{REF} , short circuit is active After PGOOD is up
Output Power Stage					
High-side MOSFET R _{DS(on)}		7	10	mΩ	V _{GS} =4.5V, I _{DS} =2A
Low-side MOSFET R _{DS(on)}		4	4.6	mΩ	V _{GS} =4.5V, I _{DS} =2A
Maximum Output Current	15			A	•

Block Diagram

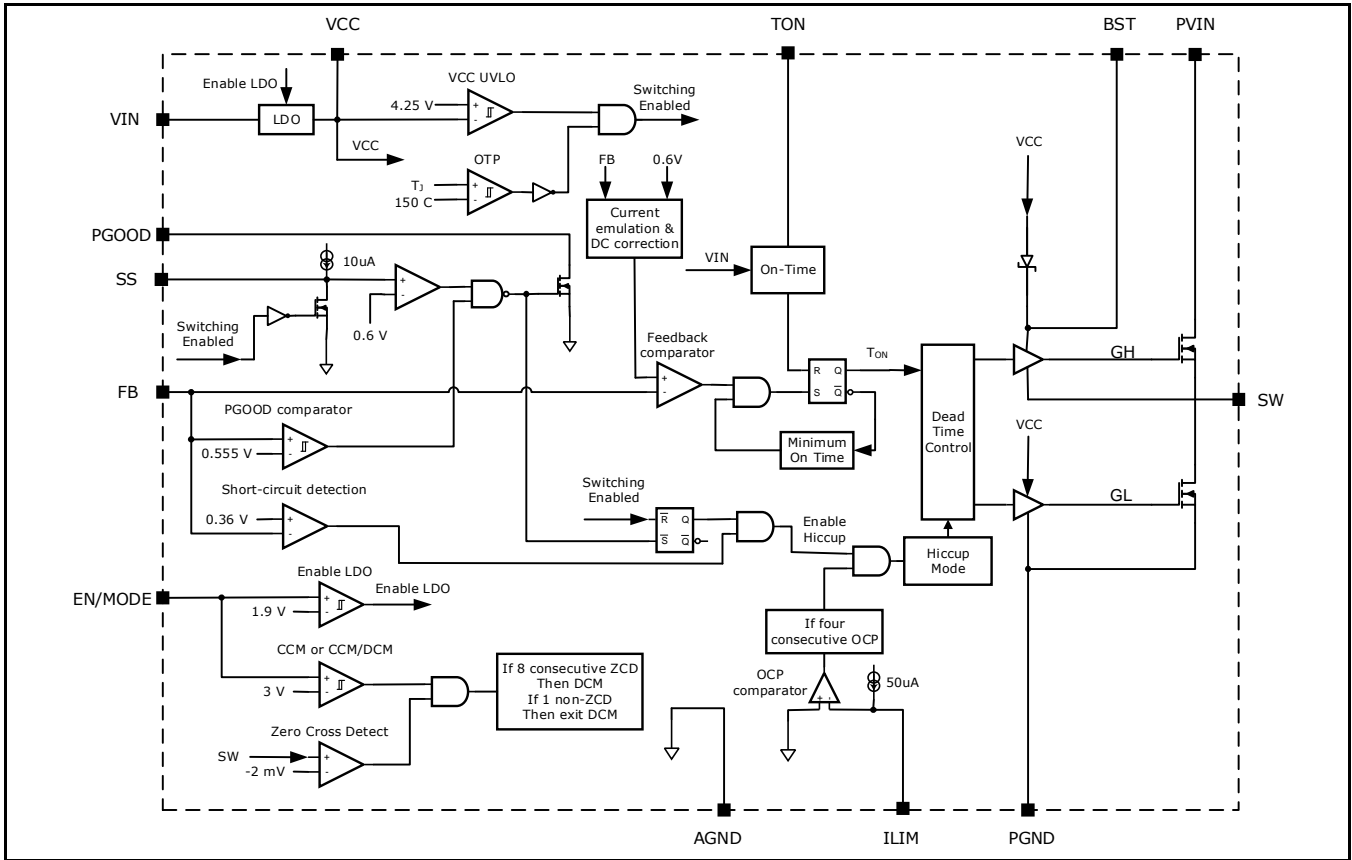

Figure 3: XR76115 Block Diagram

Pin Assignment

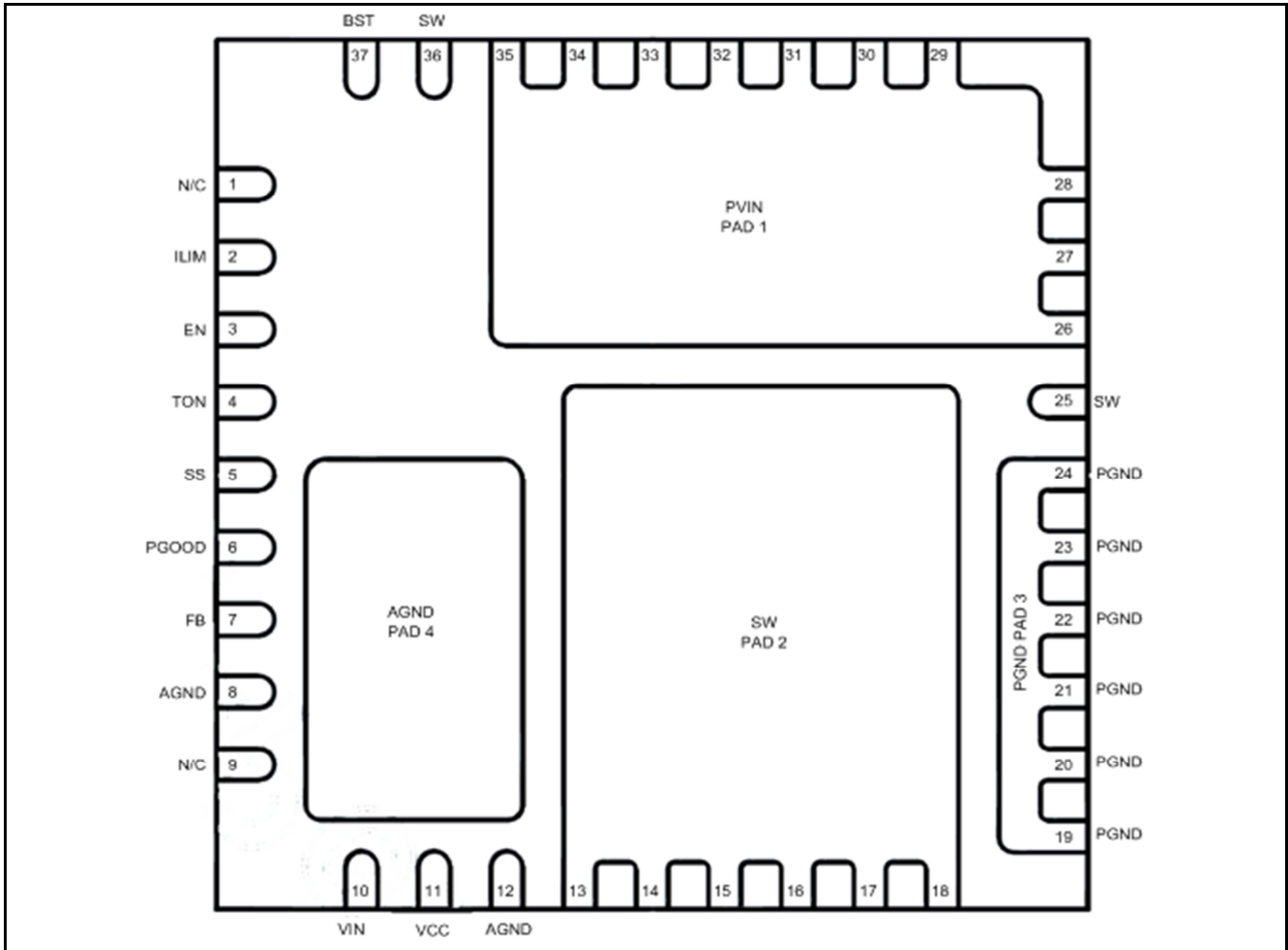

Figure 4: XR76115 Pin Assignment, top view

Pin Description

Name	Pin Number	Description
NC	1,9	Not connected.
ILIM	2	Over-current protection programming. Connect with a resistor to SW.
EN/MODE	3	Precision enable pin. Pulling this pin above 1.9V will turn the regulator on and it will operate in CCM. If the voltage is raised above 3.0V then the regulator will operate in DCM/CCM depending on load.
TON	4	Constant on-time programming pin. Connect with a resistor to AGND.
SS	5	Soft-Start pin. Connect an external capacitor between SS and AGND to program the soft-start rate based on the 10uA internal source current.
PGOOD	6	Power-good output. This open-drain output is pulled low when V_{OUT} is outside the regulation.
FB	7	Feedback input to feedback comparator. Connect with a set of resistors to V_{OUT} and AGND in order to program V_{OUT} .
AGND	8, 12, AGND Pad	Signal ground for control circuitry. Connect AGND Pad with a short trace to pins 8 and 12.
VIN	10	Supply input for the regulator's LDO. Normally it is connected to PVIN.
VCC	11	The output of regulator's LDO. For operation using a 5V rail, VCC should be shorted to VIN.
SW	13-18, 25, 36, SW Pad	Switch node. Drain of the low-side N-channel MOSFET. Source of the high-side MOSFET is wire-bonded to the SW Pad.
PGND	19-24, PGND Pad	Ground of the power stage. Should be connected to the system's power ground plane. Source of the low-side MOSFET is wire-bonded to PGND Pad.
PVIN	26-35, PVIN Pad	Input voltage for power stage. Drain of the high-side N-channel MOSFET.
BST	37	High-side driver supply pin. Connect a 1uF bootstrap capacitor between BST and SW.

Typical Performance Characteristics

All data taken at $V_{IN}=12V$, $V_{OUT}=1.2V$, $f=600kHz$, $T_A=25^{\circ}C$, No Air flow, Forced CCM, unless otherwise specified. Schematic and BOM from Applications Circuit section of this datasheet.

REGULATION

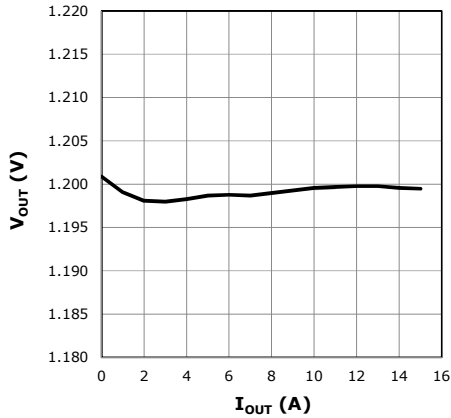

Figure 5: Load regulation, $V_{IN}=12V$

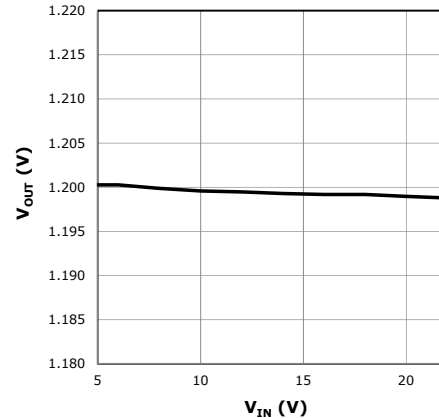

Figure 6: Line regulation, $I_{OUT}=15A$

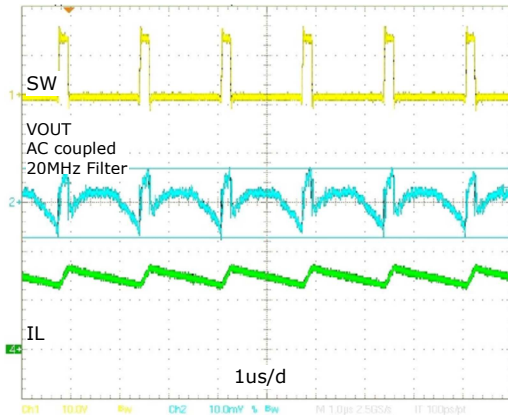

Figure 7: V_{OUT} ripple is 14mV at 15A

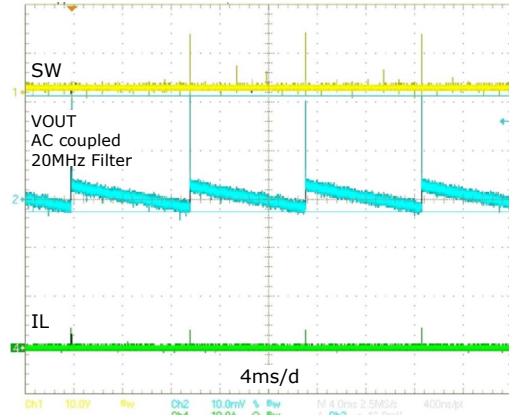

Figure 8: V_{OUT} ripple is 23mV at 0A, DCM

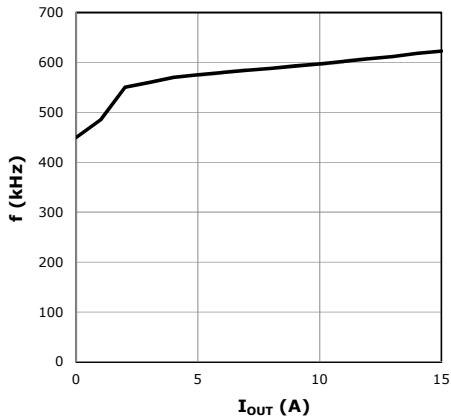

Figure 9: Frequency vs. I_{OUT} , Forced CCM

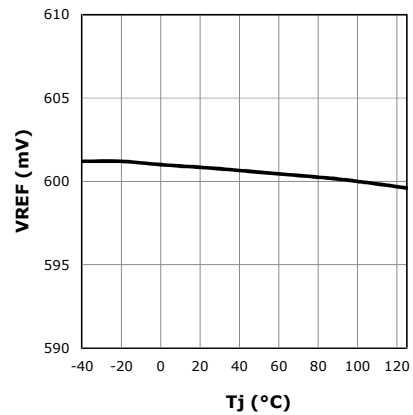

Figure 10: V_{REF} vs. temperature

Typical Performance Characteristics

All data taken at $V_{IN}=12V$, $V_{OUT}=1.2V$, $f=600kHz$, $T_A=25^\circ C$, No Air flow, Forced CCM, unless otherwise specified. Schematic and BOM from Applications Circuit section of this datasheet.

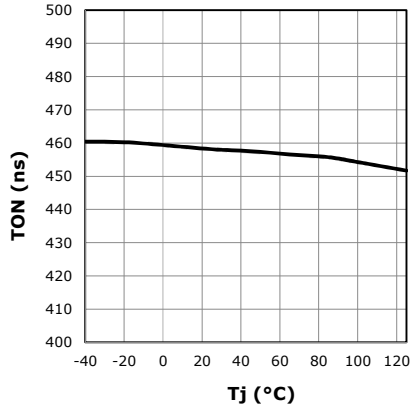

Figure 11: On-Time vs. temperature

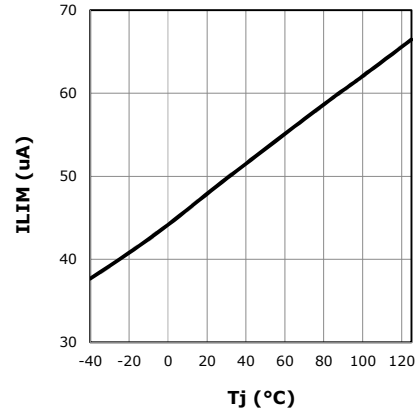

Figure 12: I_{LIM} vs. temperature

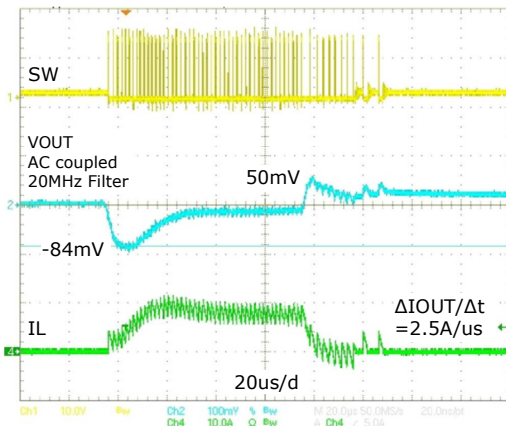

Figure 13: load step, DCM/CCM, 0A-7.5A-0A

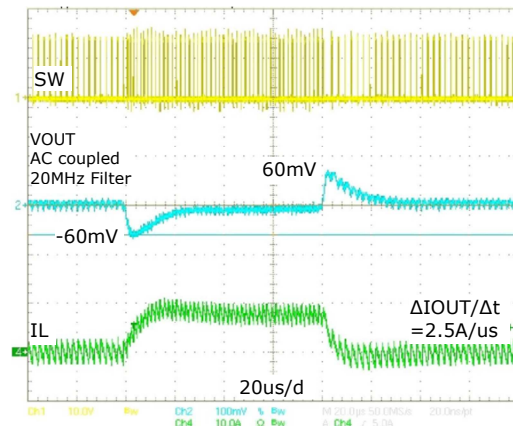

Figure 14: load step, Forced CCM, 0A-7.5A-0A

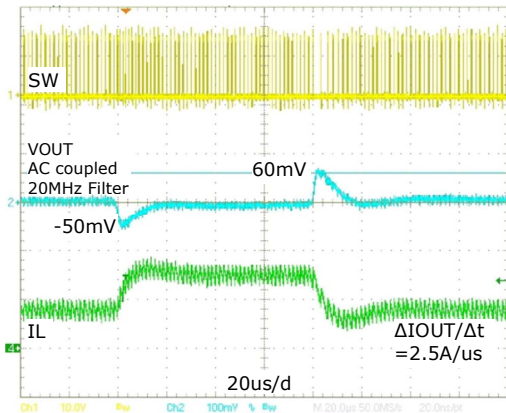

Figure 15: load step, Forced CCM, 7.5A-15A-7.5A

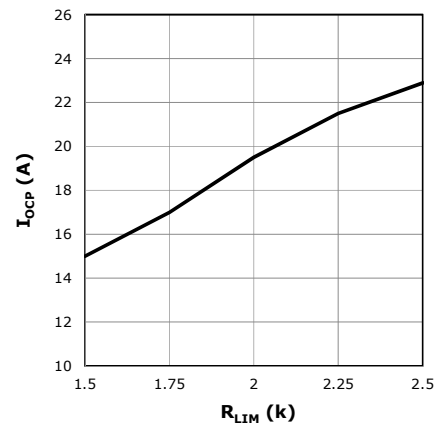

Figure 16: Typical I_{OCP} versus R_{LIM}

Powerup

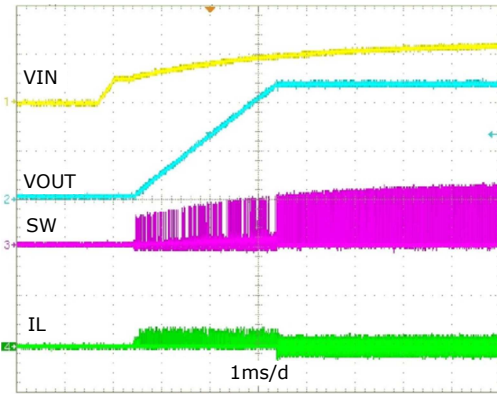

Figure 17: Powerup, Forced CCM, $I_{OUT}=0A$

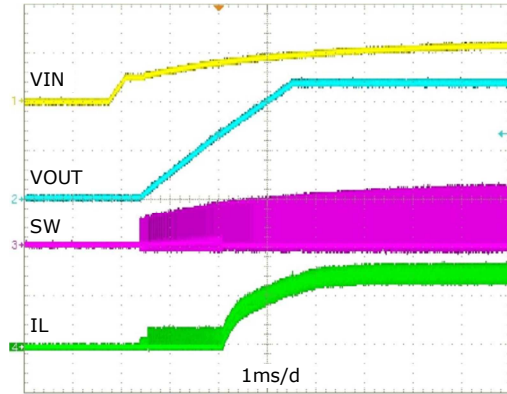

Figure 18: Powerup, Forced CCM, $I_{OUT}=15A$

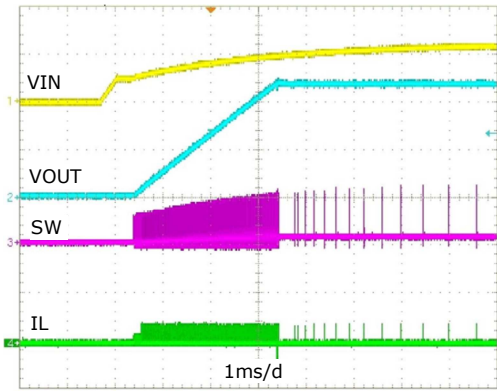

Figure 19: Powerup, DCM/CCM, $I_{OUT}=0A$

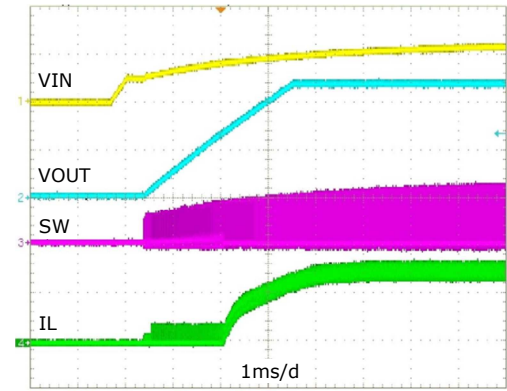

Figure 20: Powerup, DCM/CCM, $I_{OUT}=15A$

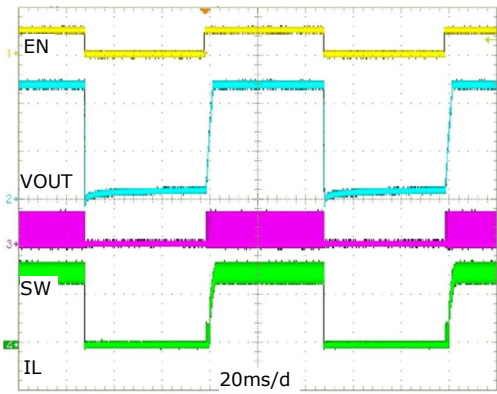

Figure 21: Enable turn on/turn off, $1.2V_{OUT}$, 15A

Efficiency and Thermal Characteristics

$T_{AMBIENT}=25^{\circ}C$, No Air flow, Inductor losses are included.

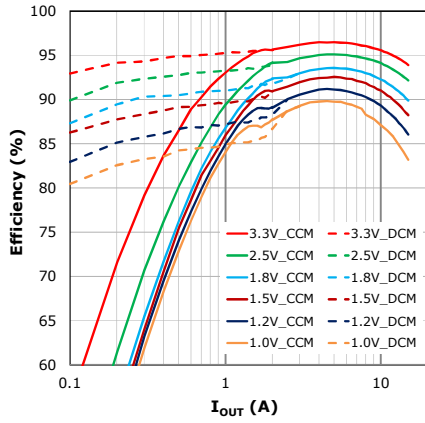

Figure 22: 5V_{IN}, 600kHz, 0.47uH

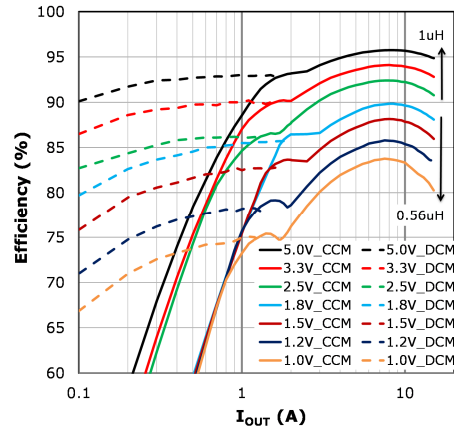

Figure 23: 12V_{IN}, 600kHz

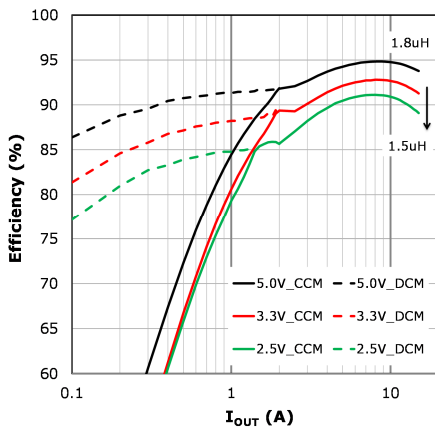

Figure 24: 22V_{IN}, 400kHz

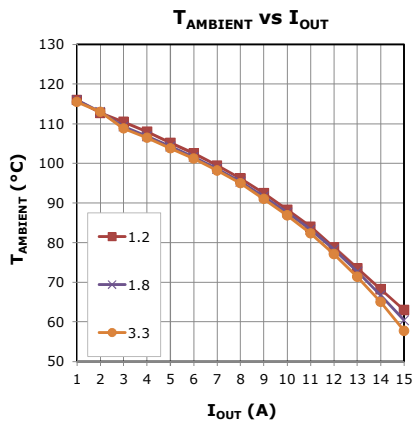

Figure 25: Package Thermal Derating, 12VIN

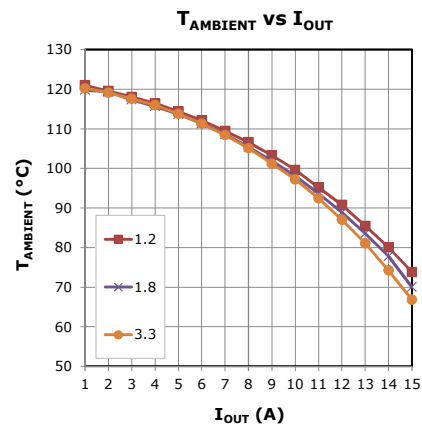

Figure 26: Package Thermal Derating, 5VIN

Detailed Operation

The XR76115 uses a synchronous step-down proprietary emulated current-mode Constant On-Time (COT) control scheme. The on-time, which is programmed via R_{ON} , is inversely proportional to V_{IN} and maintains a nearly constant frequency. The emulated current-mode control allows the use of ceramic output capacitors.

Each switching cycle begins with the high-side (switching) FET turning on for a preprogrammed time. At the end of the on-time, the high-side FET is turned off and the low-side (synchronous) FET is turned on for a preset minimum time (250ns nominal). This parameter is termed the Minimum Off-Time. After the minimum off-time the voltage at the feedback pin FB is compared to an internal voltage ramp at the feedback comparator. When V_{FB} drops below the ramp voltage, the high-side FET is turned on and the cycle repeats. This voltage ramp constitutes an emulated current ramp and allows for the use of ceramic capacitors, in addition to other capacitor types, for output filtering.

Enable/Mode

The EN/MODE pin accepts a tri-level signal that is used to control channel turn-on and turn-off. It also selects between two modes of operation: 'Forced CCM' and 'DCM/CCM'. If EN is pulled below 1.9V the regulator shuts down. A voltage between 1.9V and 3V selects the Forced CCM mode, which will run the converter in continuous conduction for all load currents. A voltage higher than 3V selects the DCM/CCM mode, which will run the converter in discontinuous conduction mode at light loads.

Selecting the Forced CCM Mode

In order to set the controller to operate in Forced CCM, a voltage between 1.9V and 3.0V must be applied to the EN/MODE pin. This can be achieved with an external control signal that meets the above voltage requirement. Where an external control is not available, the EN/MODE signal can be derived from V_{IN} . If V_{IN} is well regulated, use a resistor divider and set the voltage to 2.5V. If V_{IN} varies over a wide range, the circuit shown in Figure 27 can be used to generate the required voltage. Note that at V_{IN} of 5.5V to 22V, the nominal Zener voltage is 4.0V to 5.0V respectively. Therefore, for V_{IN} in the range of 5.5V to 22V, the circuit shown in Figure 27 will generate voltage at the EN/MODE pin required for Forced CCM.

Selecting the DCM/CCM Mode

In order to set the controller operation to DCM/CCM, a voltage between 3.1V and 5.5V must be applied to the EN/MODE pin. If an external control signal is available, it can be directly connected to the EN/MODE pin. In applications where an external control signal is not available, EN/MODE input can be derived from V_{IN} . If V_{IN} is well regulated, use a resistor divider and set the voltage to 4.0V. If V_{IN} varies over a wide range, the circuit shown in Figure 28 can be used to generate the required voltage.

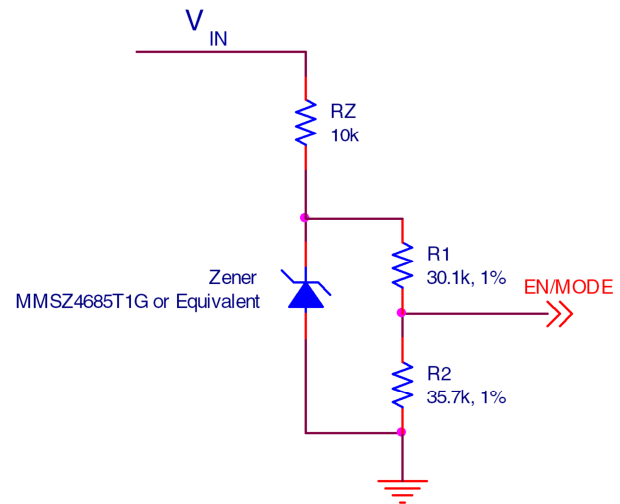

Figure 27: Selecting Forced CCM by deriving EN/MODE from V_{IN}

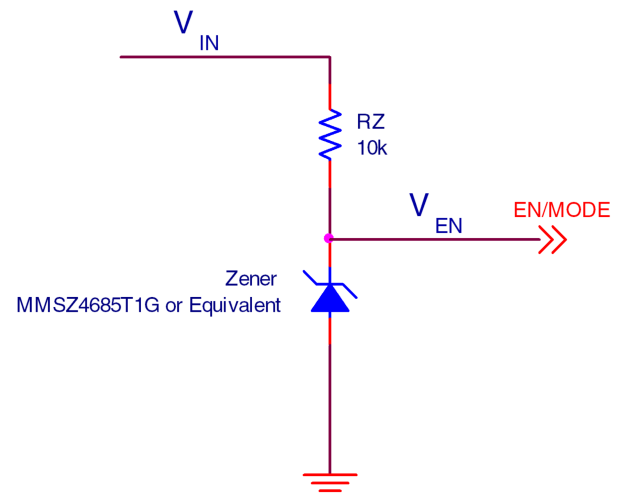

Figure 28: Selecting DCM/CCM by deriving EN/MODE from V_{IN}

Programming the On-Time

The on-time T_{ON} is programmed via resistor R_{ON} according to following equation:

$$R_{ON} = \frac{V_{IN} \times [T_{ON} - (2.5 \times 10^{-8})]}{3 \times 10^{-10}}$$

T_{ON} is calculated from:

$$T_{ON} = \frac{V_{OUT}}{V_{IN} \times f \times Eff.}$$

Where:

f is the desired switching frequency at nominal I_{OUT}

Eff. is the converter efficiency corresponding to nominal I_{OUT}

Substituting for T_{ON} in the first equation we get:

$$R_{ON} = \frac{\left(\frac{V_{OUT}}{f \times Eff.}\right) - [(2.5 \times 10^{-8}) \times V_{IN}]}{(3 \times 10^{-10})}$$

Over-Current Protection (OCP)

If the load current exceeds the programmed over-current I_{OCP} for four consecutive switching cycles, then the regulator enters the hiccup mode of operation. In hiccup mode the MOSFET gates are turned off for 110ms (hiccup timeout). Following the hiccup timeout a soft-start is attempted. If OCP persists, hiccup timeout will repeat. The regulator will remain in hiccup mode until load current is reduced below the programmed I_{OCP} . In order to program over-current protection use the following equation:

$$R_{LIM} = \frac{(I_{OCP} \times R_{DS(ON)}) + 8mV}{I_{LIM}}$$

where:

R_{LIM} is resistor value for programming I_{OCP}

I_{OCP} is the over-current value to be programmed

$R_{DS(ON)}=4.6m\Omega$ (maximum specification)

8mV is the OCP comparator offset

I_{LIM} is the internal current that generates the necessary OCP comparator threshold (use 45 μ A)

Note that I_{LIM} has a positive temperature coefficient of 0.4%/°C. This is meant to approximately match and compensate for positive temperature coefficient of the synchronous FET.

The above equation is for worst-case analysis and safeguards against premature OCP. Actual value of I_{OCP} , for a given R_{LIM} , will be higher than that predicted by the above equation. Typical I_{OCP} versus R_{LIM} is shown in Figure 16.

Short-Circuit Protection (SCP)

If the output voltage drops below 60% of its programmed value, the regulator will enter hiccup mode. Hiccup mode will persist until the short-circuit is removed. The SCP circuit becomes active after PGOOD asserts high.

Over-Temperature Protection (OTP)

OTP triggers at a nominal controller temperature of 150°C. The gates of the switching FET and the synchronous FET are turned off. When die temperature cools down to 135°C, soft-start is initiated and operation resumes.

Programming the Output Voltage

Use an external voltage divider as shown in Figure 1 to program the output voltage V_{OUT} .

$$R1 = R2 \times \left(\frac{V_{OUT}}{0.6} - 1\right)$$

The recommended value for R2 is 2k Ω .

Programming the Soft-start

Place a capacitor C_{SS} between the SS and GND pins to program the soft-start. In order to program a soft-start time of T_{SS} , calculate the required capacitance C_{SS} from the following equation:

$$C_{SS} = T_{SS} \times \frac{10\mu A}{0.6V}$$

Feed-Forward Capacitor CFF

A feed-forward capacitor C_{FF} may be necessary depending on the Equivalent Series Resistance (ESR) of C_{OUT} . If only ceramic output capacitors are used then a C_{FF} is necessary. Calculate C_{FF} from:

$$CFF = \frac{1}{2 \times \pi \times R1 \times 7 \times f_{LC}}$$

where:

R1 is the resistor that C_{FF} is placed in parallel with

f_{LC} is the frequency of the output filter double pole

f_{LC} must be less than 15kHz when using ceramic C_{OUT} . If necessary, increase C_{OUT} and/or L in order to meet this constraint.

When using capacitors with higher ESR such as Panasonic TPE series, a C_{FF} is not required provided following conditions are met:

1. The frequency of the output LC double pole f_{LC} should be less than 10kHz
2. The frequency of ESR zero $f_{ZERO,ESR}$ should be at least five times larger than f_{LC}

Note that if $f_{ZERO,ESR}$ is less than 5 x f_{LC} , then it is recommended to set the f_{LC} at less than 2kHz. C_{FF} is still not required.

Feed-Forward Resistor RFF

Poor PCB layout and/or extremely fast switching FETs can cause switching noise at the output and may couple to the FB pin via C_{FF} . Excessive noise at FB will cause poor load regulation. To solve this problem place a resistor R_{FF} in series with C_{FF} . R_{FF} value up to 2% of R1 is acceptable.

Maximum Allowable Voltage Ripple at FB Pin

Note that the steady-state voltage ripple at the feedback pin ($V_{FB,RIPPLE}$) must not exceed 50mV in order for the controller to function correctly. If $V_{FB,RIPPLE}$ is larger than 50mV then C_{OUT} should be increased as necessary in order to keep the $V_{FB,RIPPLE}$ below 50mV.

Thermal Design

Proper thermal design is critical in controlling device temperatures and in achieving robust designs. There are a number of factors that affect the thermal performance. One key factor is the temperature rise of the devices in the package, which is a function of the thermal resistances of the devices inside the package and the power being dissipated.

The thermal resistance of the XR76115 is specified in the “Operating Ratings” section of this datasheet. The JEDEC θ_{JA} thermal resistance provided is based on tests that comply with the JESD51-2A “Integrated Circuit Thermal

Test Method Environmental Conditions – Natural Convection” standard. JESD51-xx are a group of standards whose intent is to provide comparative data based on a standard test condition which includes a defined board construction. Since the actual board design in the final application will be different from the board defined in the standard, the thermal resistances in the final design may be different from those shown.

The package thermal derating curves for the XR76115 are shown in Figures 25 and 26. These correspond to input voltage of 12V and 5V respectively.

Package Specification

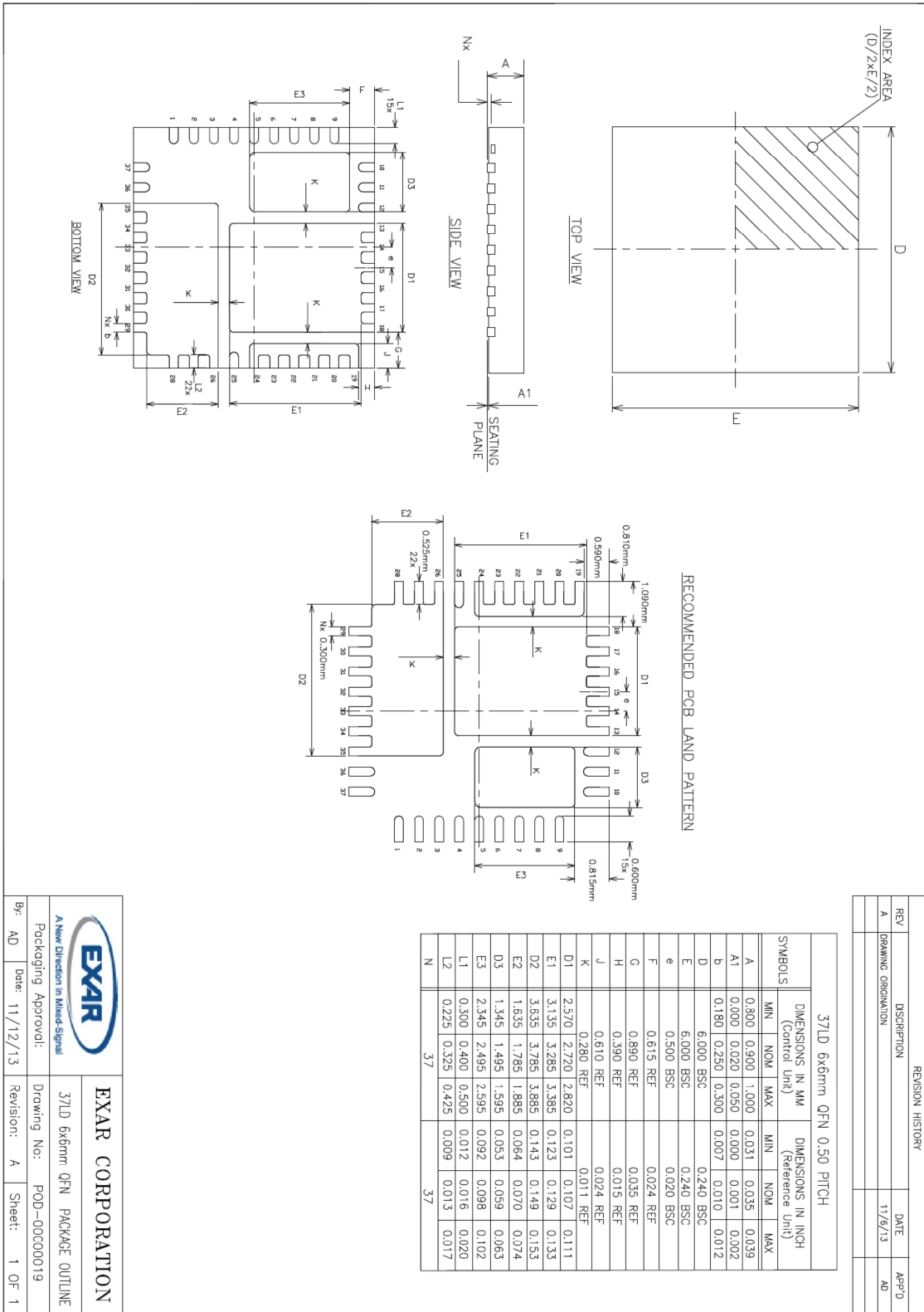

REVISION HISTORY		
REV	DESCRIPTION	DATE
A	DRAWING ORIGINATION	11/6/13
		APR'D AD

		EXAR CORPORATION	
A New Direction in Mixed-Signal Packaging Approvals:		37LD 6x6mm QFN PACKAGE OUTLINE PDD-00C00019	
By: AD	Date: 11/12/13	Revision: A	Sheet: 1 OF 1

Revision History

Revision	Date	Description
1A	March 2014	Initial release: ECN 1413-14 03-26-2014
1B	August 2015	Changed "On-Time 2" specification to: Min=170ns, Typ=200ns, Max= 230ns Changed "On-Time 3" specification to: Min=365ns, Typ=430ns, Max= 495ns Changed "f corresponding to On-Time 2" specification to: Min=362 kHz, Typ=417 kHz, Max= 490 kHz removed "f corresponding to On-Time 2" specifications for VOUT=3.3V, removed Diode Emulation Mode write up, modified Functional Block Diagram, modified Feed-Forward Capacitor write up, modified Programming the On-Time write up; added "Selecting the Forced CCM Mode", "Selecting the DCM/CCM Mode", "Feed-Forward Resistor", "Maximum Allowable Voltage Ripple at FB Pin" sections

For Further Assistance:

Email: powertechsupport@exar.com

Exar Technical Documentation: <http://www.exar.com/TechDoc/>



Exar corporation headquarters and Sales Offices

48720 Kato Road Tel.: +1 (510) 668-7000
 Fremont, CA 94538 – USA Fax: +1 (510) 668-7030

NOTICE

EXAR Corporation reserves the right to make changes to the products contained in this publication in order to improve design, performance or reliability. EXAR Corporation assumes no responsibility for the use of any circuits described herein, conveys no license under any patent or other right, and makes no representation that the circuits are free of patent infringement. Charts and schedules contained herein are only for illustration purposes and may vary depending upon a user's specific application. While the information in this publication has been carefully checked; no responsibility, however, is assumed for inaccuracies.

EXAR Corporation does not recommend the use of any of its products in life support applications where the failure or malfunction of the product can reasonably be expected to cause failure of the life support system or to significantly affect its safety or effectiveness. Products are not authorized for use in such applications unless EXAR Corporation receives, in writing, assurances to its satisfaction that: (a) the risk of injury or damage has been minimized; (b) the user assumes all such risks; (c) potential liability of EXAR Corporation is adequately protected under the circumstances.

Reproduction, in part or whole, without the prior written consent of EXAR Corporation is prohibited.