



General Description

The XR79115 is a 15A synchronous step-down Power Module for point-of-load supplies. A wide 5V to 22V input voltage range allows for single supply operation from industry standard 5V, 12V, and 19.6V rails.

With a proprietary emulated current mode Constant On-Time (COT) control scheme, the XR79115 provides extremely fast line and load transient response using ceramic output capacitors. It requires no loop compensation hence simplifying circuit implementation and reducing overall component count. The control loop also provides 0.35% load and 0.1% line regulation and maintains constant operating frequency. A selectable power saving mode allows the user to operate in discontinuous mode (DCM) at light current loads thereby significantly increasing the converter efficiency. With a 96% peak efficiency and 90% for loads as low as 100mA, the XR79115 is suitable for applications where low power losses are important.

A host of protection features, including over-current, over-temperature, short-circuit and UVLO, help achieve safe operation under abnormal operating conditions.

The XR79115 is available in a RoHS compliant, green/halogen free space-saving 68-pin 12x12x4mm QFN package. With integrated controller, drivers, bootstrap diode and capacitor, MOSFETs, inductor, CIN and COUT, this solution allows the smallest possible 15A POL design.

FEATURES

- Controller, drivers, bootstrap diode and capacitor, MOSFETs, Inductor, CIN and COUT integrated in one package
- 15A Step Down Module
 - Wide 5V to 22V Input Voltage Range
 - >0.6V Adjustable Output Voltage
- Proprietary Constant On-Time Control
 - No Loop Compensation Required
 - Stable Ceramic Output Capacitor Operation
 - Programmable 200ns to 2µs On-Time
 - Constant 400kHz to 600kHz Frequency
- Selectable CCM or CCM/DCM
 - CCM/DCM for high efficiency at light-load
 - CCM for constant frequency at light-load
- Programmable Hiccup Current Limit with Thermal Compensation
- Precision Enable and Power Good flag
- Programmable Soft-start
- 68-pin 12x12x4mm QFN package

APPLICATIONS

- Networking and Communications
- Fast Transient Point-of-Loads
- Industrial and Medical Equipment
- Embedded High Power FPGA

Ordering Information – [back page](#)

Typical Application

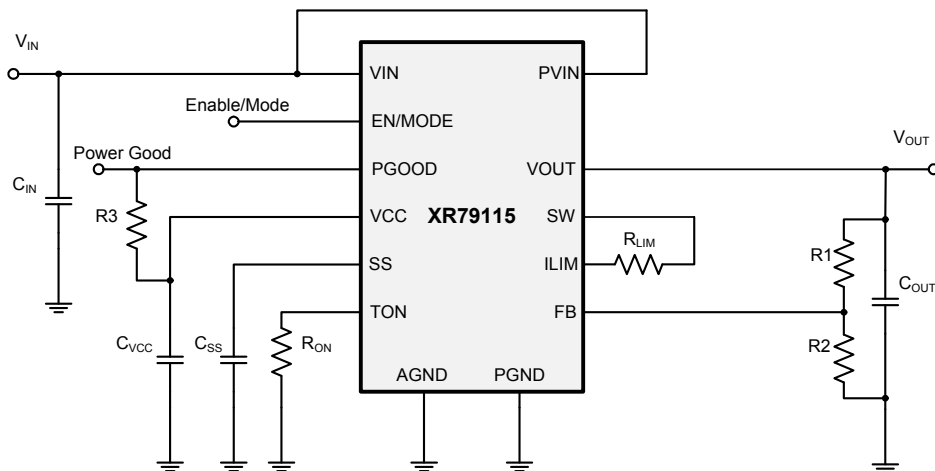

Line Regulation

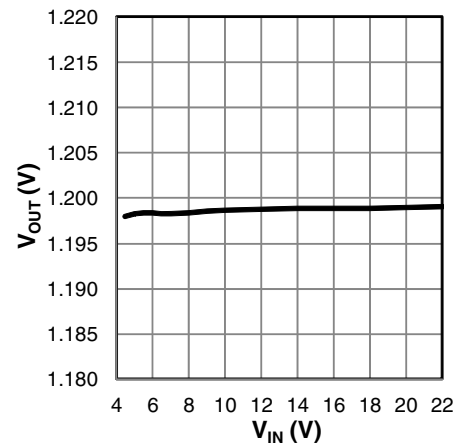

Absolute Maximum Ratings

Stresses beyond the limits listed below may cause permanent damage to the device. Exposure to any Absolute Maximum Rating condition for extended periods may affect device reliability and lifetime.

PV_{IN}, V_{IN}	-0.3V to 25V
V_{CC}	-0.3V to 6.0V
BST	-0.3V to 31V ¹
BST-SW	-0.3V to 6V
SW, ILIM	-1V to 25V ^{1,2}
ALL other pins	-0.3V to $V_{CC}+0.3V$
Storage Temperature	-65°C to +150°C
Junction Temperature	150°C
Power Dissipation	Internally Limited
Lead Temperature (Soldering, 10 sec)	260°C MSL3
ESD Rating (HBM - Human Body Model)	2kV

Operating Conditions

PV_{IN}	3V to 22V
V_{IN}	4.5V to 22V
V_{CC}	4.5V to 5.5V
SW, ILIM	-1V to 22V ¹
PGOOD, V_{CC} , T_{ON} , SS, EN, FB	-0.3V to 5.5V
Switching Frequency	400kHz to 600kHz ³
Junction Temperature Range	-40°C to +125°C
JEDEC51 Package Thermal Resistance, θ_{JA}	15.4°C/W
Package Power Dissipation at 25°C	6.5W

Note 1: No external voltage applied.

Note 2: SW pin's minimum DC range is -1V, transient is -5V for less than 50ns.

Note 3: Recommended frequency for optimum performance

Electrical Characteristics

Unless otherwise noted: $T_J = 25^\circ\text{C}$, $V_{IN} = 12\text{V}$, $BST = V_{CC}$, $SW = AGND = PGND = 0\text{V}$, $C_{VCC} = 4.7\mu\text{F}$. Limits applying over the full operating temperature range are denoted by a “•”

Symbol	Parameter	Conditions		Min	Typ	Max	Units
Power Supply Characteristics							
V_{IN}	Input Voltage Range	VCC regulating	•	5		22	V
		VCC tied to VIN	•	4.5		5.5	
I_{VIN}	VIN Input Supply Current	Not switching, $V_{IN} = 12\text{V}$, $V_{FB} = 0.7\text{V}$	•		0.7	2	mA
I_{VCC}	VCC Quiescent Current	Not switching, $V_{CC} = V_{IN} = 5\text{V}$, $V_{FB} = 0.7\text{V}$	•		0.7	2	mA
I_{VIN}	VIN Input Supply Current	$f = 500\text{kHz}$, $R_{ON} = 61.9\text{k}$, $V_{FB} = 0.58\text{V}$			17		mA
I_{OFF}	Shutdown Current	Enable = 0V, $V_{IN} = 12\text{V}$			1		μA
Enable and Under-Voltage Lock-Out UVLO							
V_{IH_EN}	EN Pin Rising Threshold		•	1.8	1.9	2.0	V
V_{EN_HYS}	EN Pin Hysteresis				50		mV
V_{IH_EN}	EN Pin Rising Threshold for DCM/CCM operation		•	2.8	3.0	3.1	V
V_{EN_HYS}	EN Pin Hysteresis				100		mV

Symbol	Parameter	Conditions		Min	Typ	Max	Units
	VCC UVLO Start Threshold, Rising Edge		•	4.00	4.25	4.40	V
	VCC UVLO Hysteresis				200		mV
Reference Voltage							
V _{REF}	Reference Voltage	V _{IN} = 5V to 22V, VCC regulating		0.597	0.600	0.603	V
		V _{IN} = 4.5V to 5.5V, VCC tied to VIN		0.596	0.600	0.604	V
		V _{IN} = 5V to 22V, VCC regulating	•	0.594	0.600	0.606	V
		V _{IN} = 4.5V to 5.5V, VCC tied to VIN					
	DC Line Regulation	CCM, closed loop, V _{IN} =4.5V-22V, applies to any C _{OUT}			±0.10		%
	DC Load Regulation	CCM, closed loop, I _{OUT} =0A-15A, applies to any C _{OUT}			±0.35		%
Programmable Constant On-Time							
T _{ON(MIN)}	Minimum Programmable On-Time	R _{ON} = 6.98k, V _{IN} = 22V			120		ns
T _{ON2}	On-Time 2	R _{ON} = 6.98k, V _{IN} = 12V	•	156	192	228	ns
	f Corresponding to On-Time 2	V _{OUT} = 1.0V		450	535	660	kHz
T _{ON3}	On-Time 3	R _{ON} = 16.2k, V _{IN} = 12V	•	341	412	483	ns
	Minimum Off-Time		•		250	350	ns
Diode Emulation Mode							
	Zero Crossing Threshold	DC value measured during test			-2		mV
Soft-start							
	SS Charge Current		•	-14	-10	-6	µA
	SS Discharge Current	Fault present	•	1			mA
VCC Linear Regulator							
	VCC Output Voltage	V _{IN} = 6V to 22V, I _{LOAD} = 0 to 30mA	•	4.8	5.0	5.2	V
		V _{IN} = 5V, I _{LOAD} = 0 to 20mA	•	4.6	4.8		V
Power Good Output							
	Power Good Threshold			-10	-7.5	-5	%
	Power Good Hysteresis				2	4	%
	Power Good Sink Current			1			mA
Protection: OCP, OTP, Short-Circuit							
	Hiccup Timeout				110		ms
	ILIM Pin Source Current			45	50	55	µA
	ILIM Current Temperature Coefficient				0.4		%/°C
	OCP Comparator Offset		•	-8	0	+8	mV

Symbol	Parameter	Conditions		Min	Typ	Max	Units
	Current Limit Blanking	GL rising > 1V			100		ns
	Thermal Shutdown Threshold ¹	Rising temperature			150		°C
	Thermal Hysteresis ¹				15		°C
	VSCTH Feedback Pin Short-Circuit Threshold	Percent of V_{REF} short circuit is active after PGOOD is asserted	•	50	60	70	%
Output Power Stage							
$R_{DS(on)}$	High-Side MOSFET $R_{DS(on)}$	$I_{DS} = 2A, V_{GS} = 4.5V$			8.3	10	mΩ
	Low-Side MOSFET $R_{DS(on)}$				4.2	5	mΩ
I_{OUT}	Maximum Output Current		•	15			A
L	Output Inductance			0.45	0.56	0.67	μH
C_{IN}	Input Capacitance				1		μF
C_{OUT}	Output Capacitance				2.2		μF
C_{BST}	Bootstrap Capacitance				0.1		μF

Note 1: Guaranteed by design

Pin Configuration, Top View

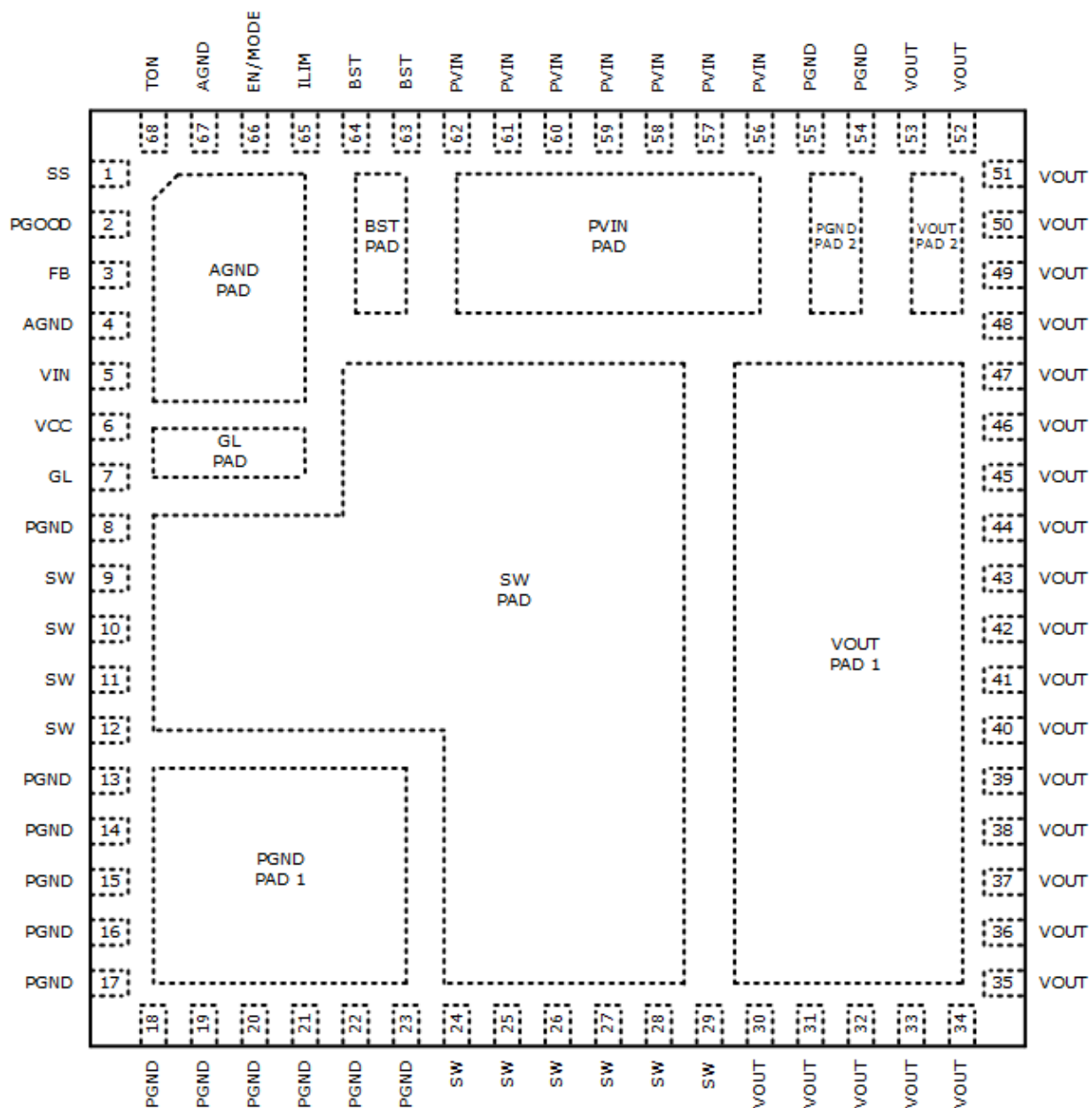

Pin Assignments

Pin No.	Pin Name	Type	Description
1	SS	A	Soft-start pin. Connect an external capacitor between SS and AGND to program the soft-start rate based on the 10uA internal source current.
2	PGOOD	OD, O	Power-good output. This open-drain output is pulled low when V_{OUT} is outside the regulation.
3	FB	A	Feedback input to feedback comparator. Connect with a set of resistors to V_{OUT} and AGND in order to program V_{OUT} .
4, 67, AGND Pad	AGND	A	Analog ground. Control circuitry of the IC is referenced to this pin.
5	VIN	PWR	IC supply input. Provides power to internal LDO.
6	VCC	PWR	The output of LDO. Bypass with a 4.7uF capacitor to AGND. For operation from a 5V _{IN} rail, VCC should be tied to VIN.
7, GL pad	GL	O	Driver output for Low-side N-channel synchronous MOSFET. It is internally connected to the gate of the FET. Leave this pin floating.
8	PGND	PWR	Controller low-side driver ground. Connect with a short trace to closest PGND pins or PGND pad.
13-23, 54, 55, PGND pads	PGND	PWR	Ground of the power stage. Should be connected to the system's power ground plane.
9-12, 24-29, SW Pad	SW	PWR	Switching node. It is internally connected. Use thermal vias and/or sufficient PCB land area in order to heatsink the low-side FET and the inductor.
30-53, VOUT pads	VOUT	PWR	Output of the power stage. Place the output filter capacitors as close as possible to these pins.
56-62, PVIN Pad	PVIN	PWR	Power stage input voltage. Place the input filter capacitors as close as possible to these pins.
63, 64, BST Pad	BST	A	Controller high-side driver supply pin. It is internally connected to SW via a 0.1uF bootstrap capacitor. Leave these pins floating.
65	ILIM	A	Over-current protection programming. Connect with a short trace to SW pins.
66	EN/MODE	I	Precision enable pin. Pulling this pin above 1.9V will turn the IC on and it will operate in Forced CCM. If the voltage is raised above 3.0V, then the IC will operate in DCM or CCM depending on load.
68	TON	A	Constant on-time programming pin. Connect with a resistor to AGND.

Type: A = Analog, I = Input, O = Output, I/O = Input/Output, PWR = Power, OD = Open-Drain

Functional Block Diagram

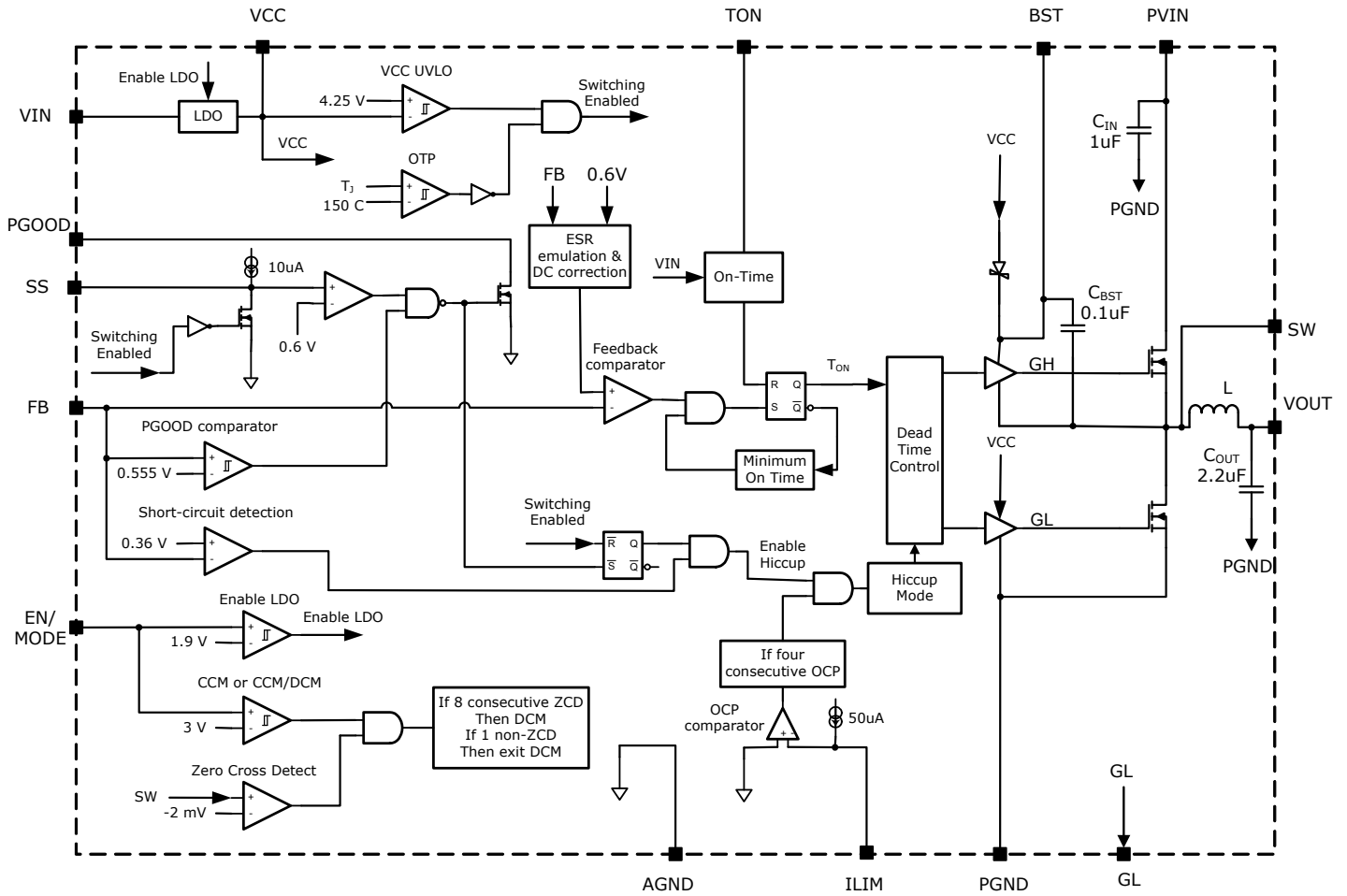

Typical Performance Characteristics

Unless otherwise noted: $V_{IN} = 12V$, $V_{OUT}=1.2V$, $I_{OUT}=15A$, $f=500kHz$, $T_A = 25^\circ C$. Schematic from the application information section.

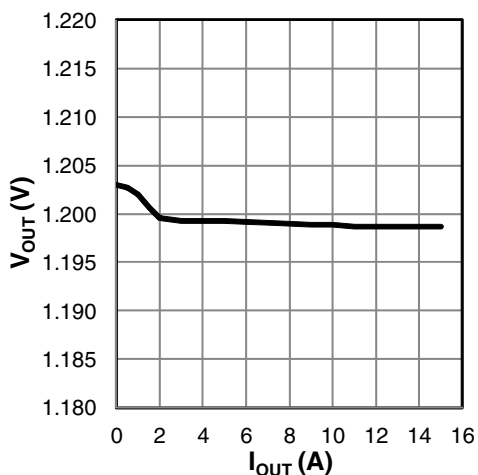

Figure 1: Load Regulation

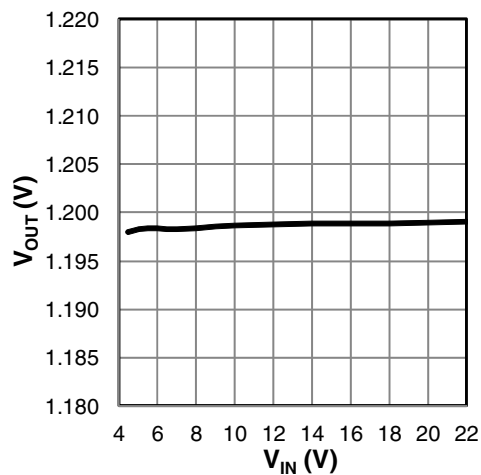

Figure 2: Line regulation

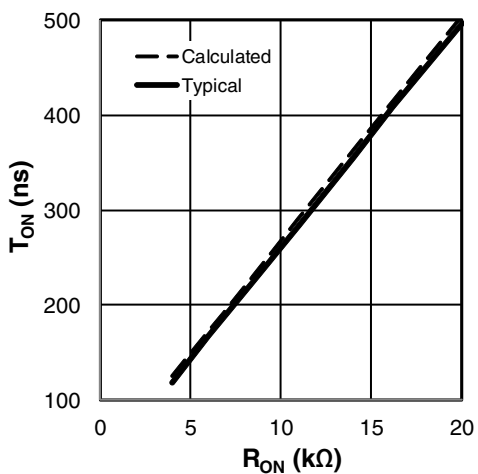

Figure 3: T_{ON} versus R_{ON}

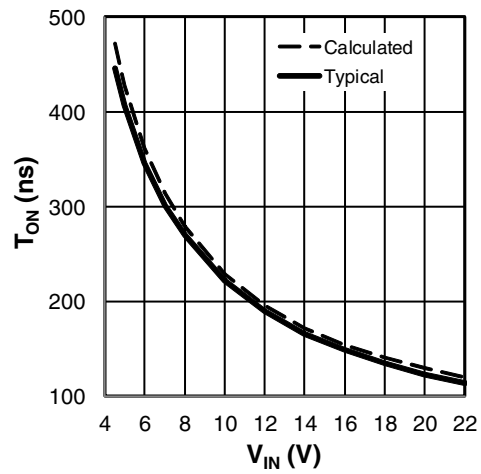

Figure 4: T_{ON} versus V_{IN} , $R_{ON}=6.98k$

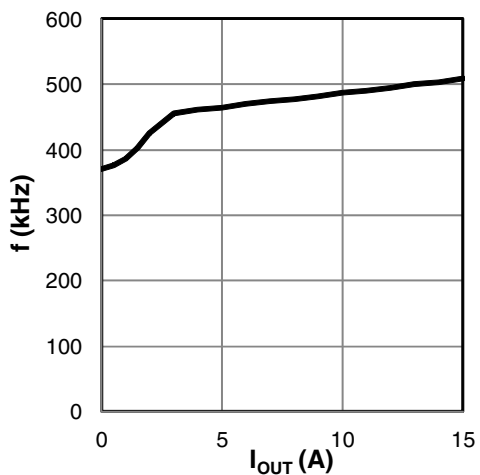

Figure 5: frequency versus I_{OUT}

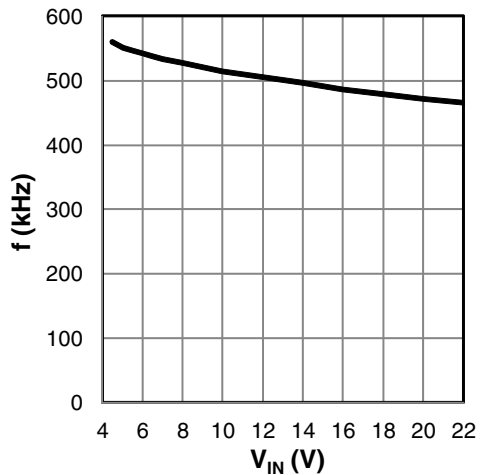

Figure 6: frequency versus V_{IN}

Typical Performance Characteristics

Unless otherwise noted: $V_{IN} = 12V$, $V_{OUT}=1.2V$, $I_{OUT}=15A$, $f=500kHz$, $T_A = 25^\circ C$. Schematic from the application information section.

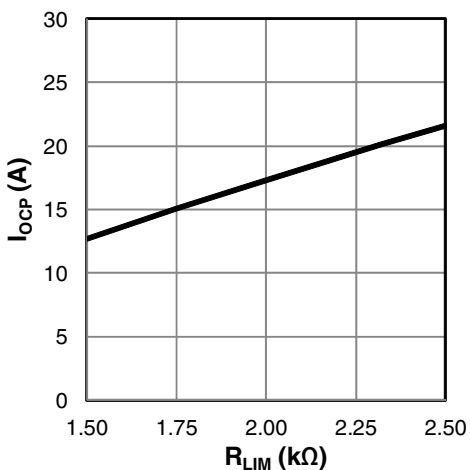

Figure 7: I_{OCP} versus R_{LIM}

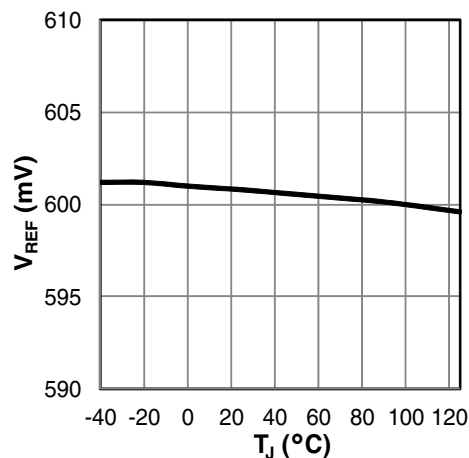

Figure 8: V_{REF} versus temperature

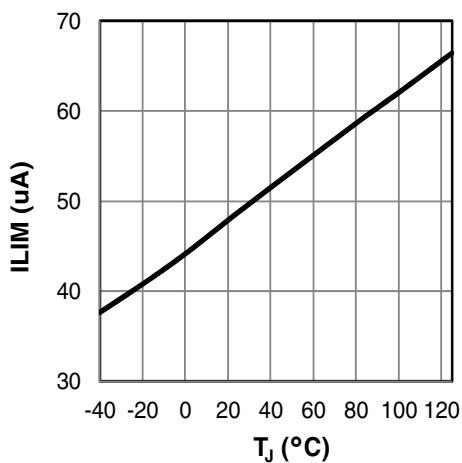

Figure 9: I_{LIM} versus temperature

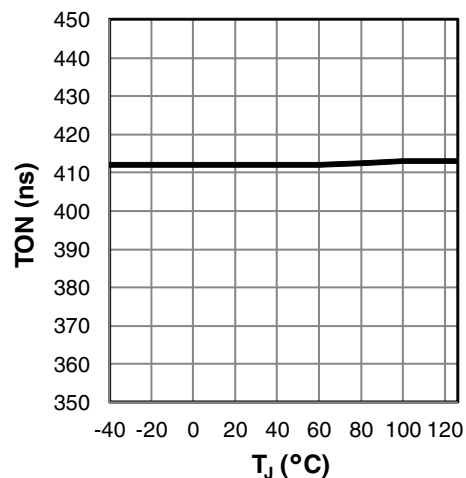

Figure 10: T_{ON} versus temperature, $R_{ON}=16.2k\Omega$

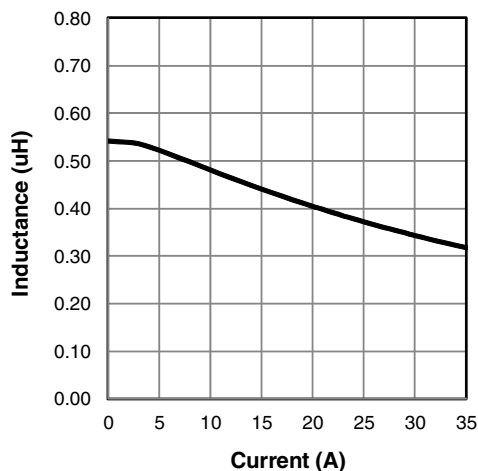

Figure 11: Inductance versus Current

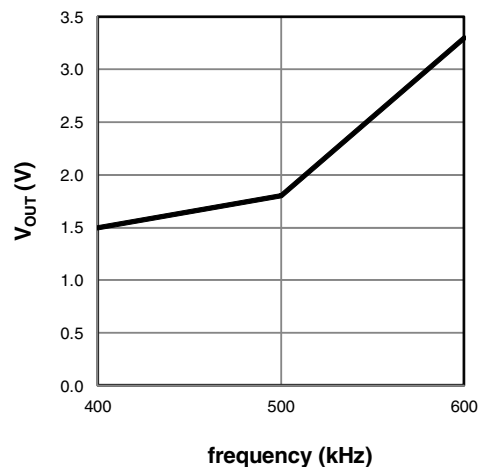

Figure 12: Maximum recommended V_{OUT} versus f , $V_{IN}=12V$

Typical Performance Characteristics

Unless otherwise noted: $V_{IN} = 12V$, $V_{OUT} = 1.2V$, $I_{OUT} = 15A$, $f = 500kHz$, $T_A = 25^\circ C$. Schematic from the application information section.

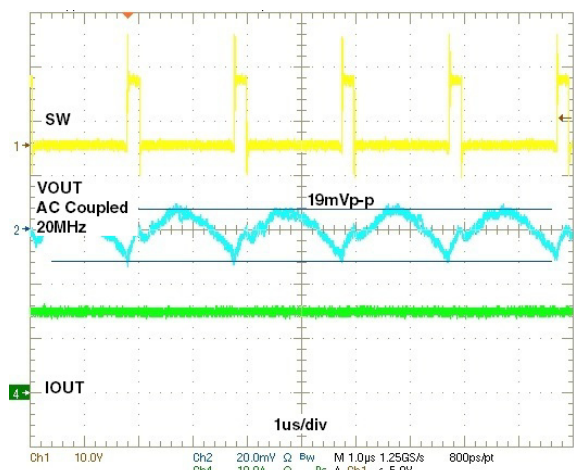

Figure 13: Steady state, CCM, $I_{OUT} = 15A$

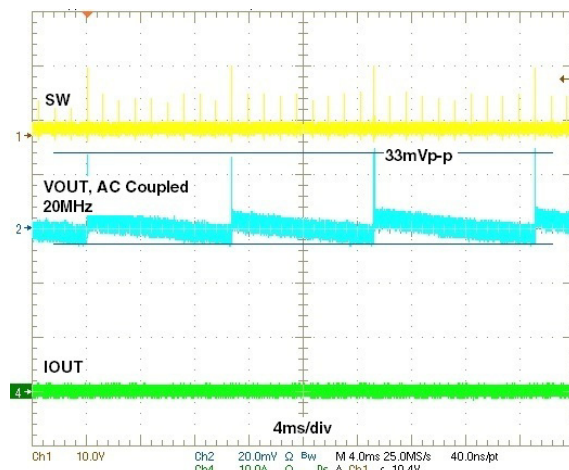

Figure 14: Steady state, DCM, $I_{OUT} = 0A$

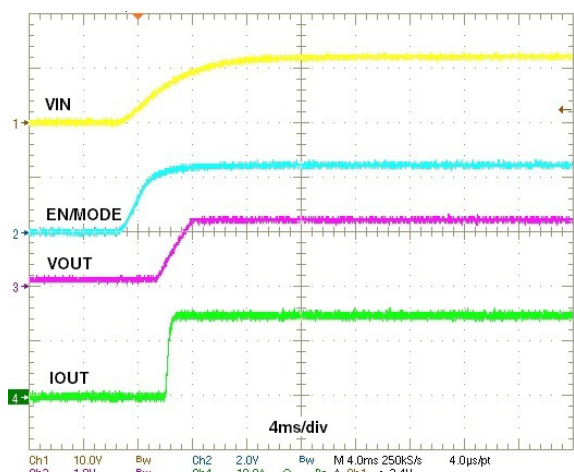

Figure 15: Power up, Forced CCM

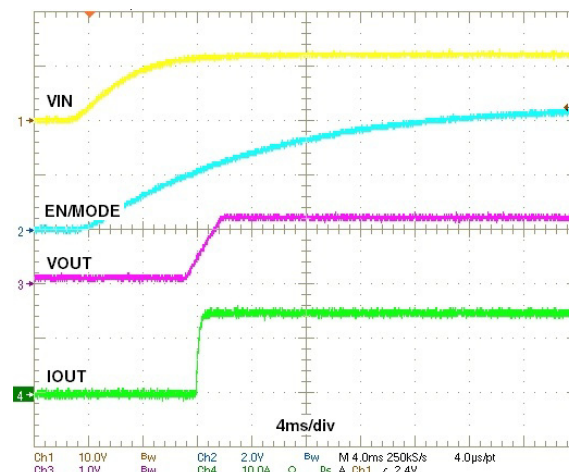

Figure 16: Power up, DCM/CCM

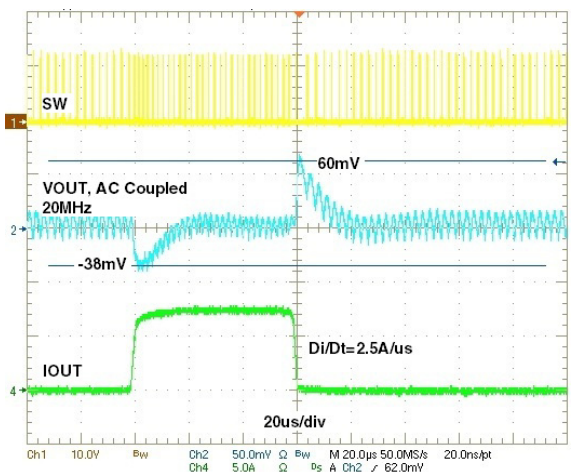

Figure 17: Load step, Forced CCM, 0A-7.5A-0A

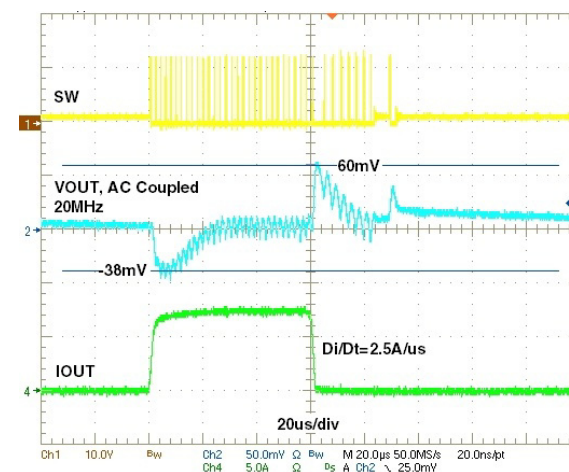

Figure 18: Load step, DCM/CCM, 0A-7.5A-0A

Efficiency and Package Thermal Derating

Unless otherwise noted: $T_{AMBIENT} = 25^{\circ}C$, No Air flow, $f=500kHz$, Schematic from the application information section.

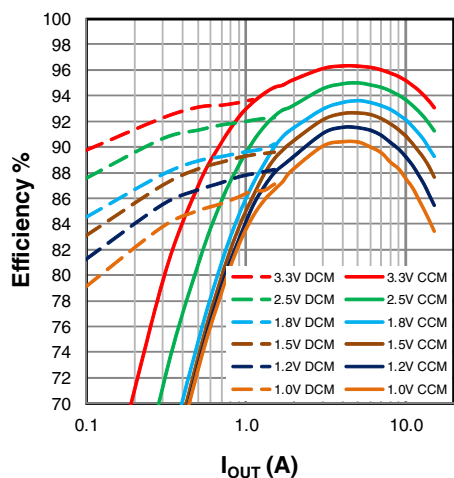

Figure 19: Efficiency, $V_{IN}=5V$

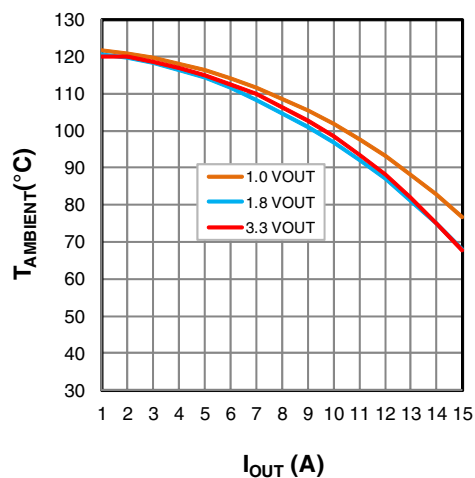

Figure 20: Maximum $T_{AMBIENT}$ vs I_{OUT} , $V_{IN}=5V$

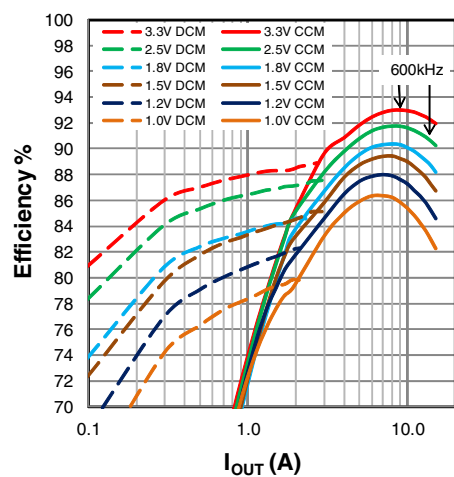

Figure 21: Efficiency, $V_{IN}=12V$

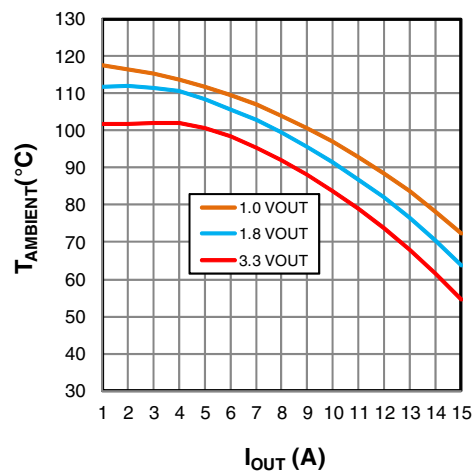

Figure 22: Maximum $T_{AMBIENT}$ vs I_{OUT} , $V_{IN}=12V$

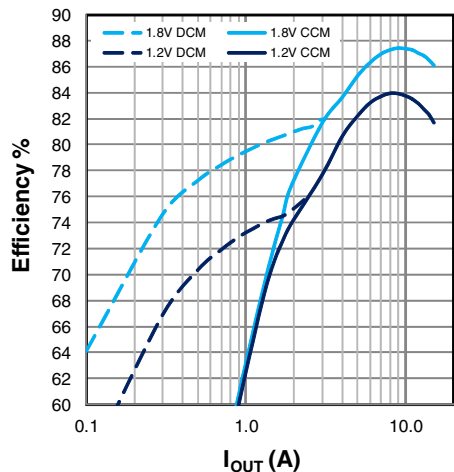

Figure 23: Efficiency, $V_{IN}=19.6V$

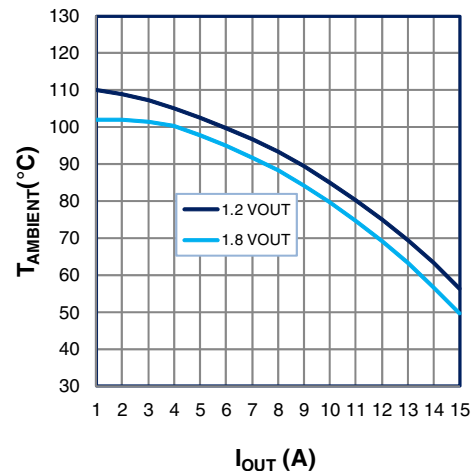

Figure 24: Maximum $T_{AMBIENT}$ vs I_{OUT} , $V_{IN}=19.6V$

Functional Description

XR79115 is a synchronous step-down proprietary emulated current-mode Constant On-Time (COT) Module. The on-time, which is programmed via R_{ON} , is inversely proportional to V_{IN} and maintains a nearly constant frequency. The emulated current-mode control is stable with ceramic output capacitors.

Each switching cycle begins with GH signal turning on the high-side (switching) FET for a preprogrammed time. At the end of the on-time, the high-side FET is turned off and the low-side (synchronous) FET is turned on for a preset minimum time (250ns nominal). This parameter is termed Minimum Off-Time. After the minimum off-time, the voltage at the feedback pin FB is compared to an internal voltage ramp at the feedback comparator. When V_{FB} drops below the ramp voltage, the high-side FET is turned on and the cycle repeats. This voltage ramp constitutes an emulated current ramp and makes possible the use of ceramic capacitors, in addition to other capacitor types, for output filtering.

Enable/Mode Input (EN/MODE)

EN/MODE pin accepts a tri-level signal that is used to control turn on/off. It also selects between two modes of operation: 'Forced CCM' and 'DCM/CCM'. If EN is pulled below 1.8V, the Module shuts down. A voltage between 2.0V and 2.8V selects the Forced CCM mode which will run the Module in continuous conduction at all times. A voltage higher than 3.1V selects the DCM/CCM mode which will run the Module in discontinuous conduction at light loads.

Selecting the Forced CCM Mode

In order to set the Module to operate in Forced CCM, a voltage between 2.0V and 2.8V must be applied to EN/MODE. This can be achieved with an external control signal that meets the above voltage requirement. Where an external control is not available, the EN/MODE can be derived from V_{IN} . If V_{IN} is well regulated, use a resistor divider and set the voltage to 2.5V. If V_{IN} varies over a wide range, the circuit shown in figure 25 can be used to generate the required voltage. Note that at V_{IN} of 5V and 22V the nominal Zener voltage is 3.8V and 4.7V respectively. Therefore for V_{IN} in the range of 5V to 22V, the circuit shown in figure 25 will generate V_{EN} required for Forced CCM.

Selecting the DCM/CCM Mode

In order to set the Module operation to DCM/CCM, a voltage between 3.1V and 5.5V must be applied to EN/MODE pin. If an external control signal is available, it can be directly connected to EN/MODE. In applications where an external control is not available, EN/MODE input can be derived from V_{IN} . If V_{IN} is well regulated, use a resistor

divider and set the voltage to 4V. If V_{IN} varies over a wide range, the circuit shown in figure 26 can be used to generate the required voltage.

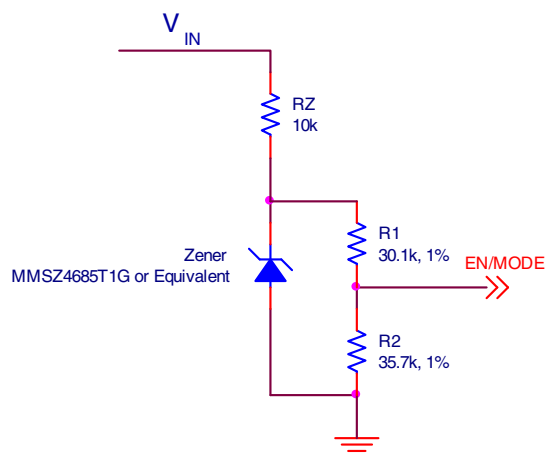

Figure 25: Selecting Forced CCM by deriving EN/MODE from V_{IN}

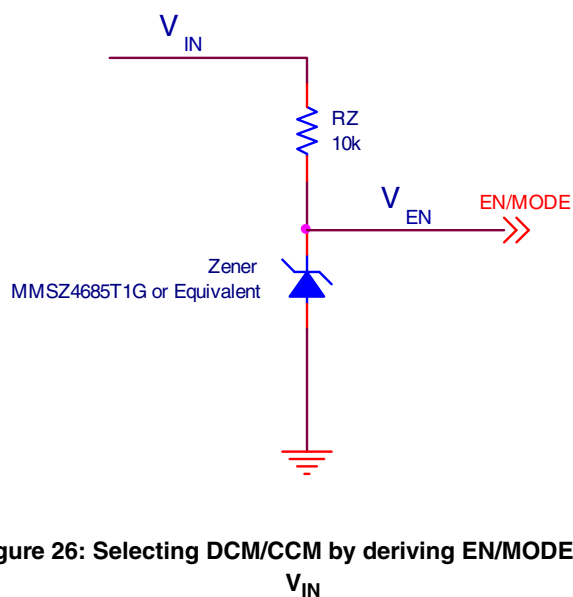

Figure 26: Selecting DCM/CCM by deriving EN/MODE from V_{IN}

Programming the On-Time

The On-Time T_{ON} is programmed via resistor R_{ON} according to following equation:

$$R_{ON} = \frac{V_{IN} \times [T_{ON} - (25 \times 10^{-9})]}{2.85 \times 10^{-10}}$$

where T_{ON} is calculated from:

$$T_{ON} = \frac{V_{OUT}}{V_{IN} \times f \times Eff}$$

where:

f is the desired switching frequency at nominal I_{OUT}

Eff is the Module efficiency corresponding to nominal I_{OUT} shown in figures 19, 21, 23

Substituting for T_{ON} in the first equation we get:

$$R_{ON} = \frac{\left(\frac{V_{OUT}}{f \times Eff}\right) - [(25 \times 10^{-9}) \times V_{IN}]}{2.85 \times 10^{-10}}$$

Over-Current Protection (OCP)

If load current exceeds the programmed over-current, I_{OCP} for four consecutive switching cycles, then Module enters hiccup mode of operation. In hiccup, the MOSFET gates are turned off for 110ms (hiccup timeout). Following the hiccup timeout, a soft-start is attempted. If OCP persists, hiccup timeout will repeat. The Module will remain in hiccup mode until load current is reduced below the programmed I_{OCP} . In order to program the over-current protection, use the following equation:

$$RLIM = \frac{(I_{OCP} \times R_{DS}) + 8mV}{ILIM}$$

Where:

$RLIM$ is resistor value for programming I_{OCP}

I_{OCP} is the over-current threshold to be programmed

R_{DS} is the MOSFET rated On Resistance (5m Ω)

8mV is the OCP comparator maximum offset

$ILIM$ is the internal current that generates the necessary OCP comparator threshold (use 45 μ A).

Note that $ILIM$ has a positive temperature coefficient of 0.4%/°C (figure 9). This is meant to roughly match and compensate for positive temperature coefficient of the synchronous FET. Graph of typical I_{OCP} versus $RLIM$ is shown in figure 7.

Short-Circuit Protection (SCP)

If the output voltage drops below 60% of its programmed value, the Module will enter hiccup mode. Hiccup will persist until short-circuit is removed. SCP circuit becomes active after PGOOD asserts high.

Over-Temperature (OTP)

OTP triggers at a nominal die temperature of 150°C. The gate of switching FET and synchronous FET are turned off. When die temperature cools down to 135°C, soft-start is initiated and operation resumes.

Programming the Output Voltage

Use an external voltage divider as shown in the Application Circuit to program the output voltage V_{OUT} .

$$R1 = R2 \times \left(\frac{V_{OUT}}{0.6} - 1\right)$$

where $R2$ has a nominal value of 2k Ω .

Programming the Soft-start

Place a capacitor CSS between the SS and AGND pins to program the soft-start. In order to program a soft-start time of TSS, calculate the required capacitance CSS from the following equation:

$$CSS = TSS \times \left(\frac{10\mu A}{0.6V}\right)$$

Feed-Forward Capacitor (C_{FF})

A feed-forward capacitor (C_{FF}) may be necessary depending on the Equivalent Series Resistance (ESR) of C_{OUT} . If

only ceramic output capacitors are used for C_{OUT} then a C_{FF} is necessary. Calculate C_{FF} from:

$$C_{FF} = \frac{1}{2 \times \pi \times 80kHz \times R1}$$

where:

$R1$ is the resistor that C_{FF} is placed in parallel with

80kHz is the location of the Zero formed by $R1$ and C_{FF}

Note that minimum required C_{OUT} is 140uF when using ceramic capacitors.

When using capacitors with higher ESR, such as PANASONIC TPE series, a C_{FF} is not required provided following conditions are met:

1. The frequency of output filter LC double-pole f_{LC} should be less than 15kHz.
2. The frequency of ESR Zero $f_{Zero,ESR}$ should be at least three times larger than f_{LC} .

As an example the application circuit has $f_{LC}=8.3kHz$ and $f_{Zero,ESR}=23.4kHz$.

Note that the steady-state voltage ripple at feedback pin FB ($V_{FB,RIPPLE}$) must not exceed 50mV in order for Module to function correctly. If $V_{FB,RIPPLE}$ is larger than 50mV then C_{OUT} should be increased as necessary in order to keep the $V_{FB,RIPPLE}$ below 50mV.

Feed-Forward Resistor (R_{FF})

Poor PCB layout can cause FET switching noise at the output and may couple to the FB pin via C_{FF} . Excessive noise at FB will cause poor load regulation. To solve this problem place a resistor R_{FF} in series with C_{FF} . R_{FF} value up to 2% of $R1$ is acceptable.

Application Circuit

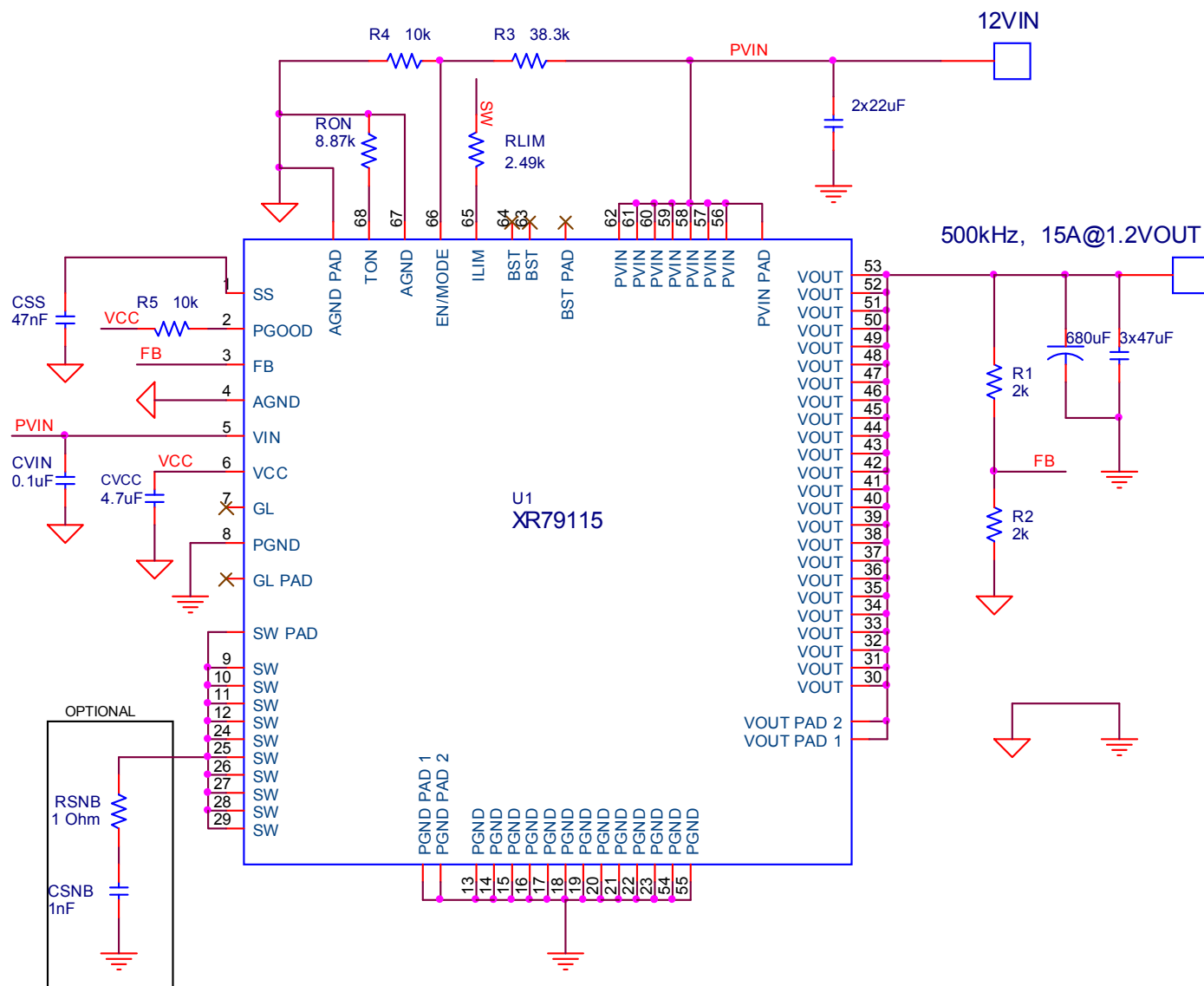

Mechanical Dimensions

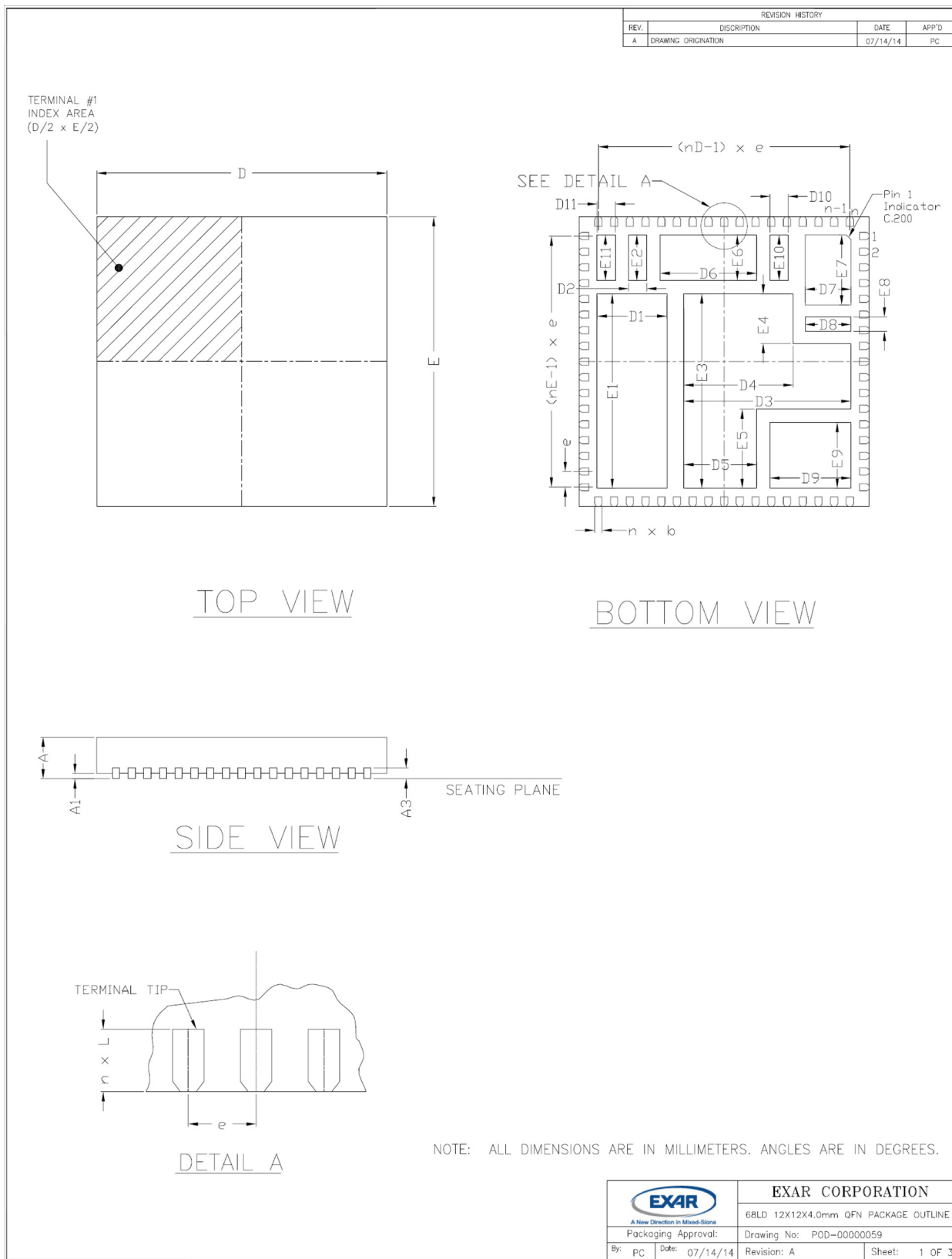

TERMINAL AND PAD EDGE DETAILS

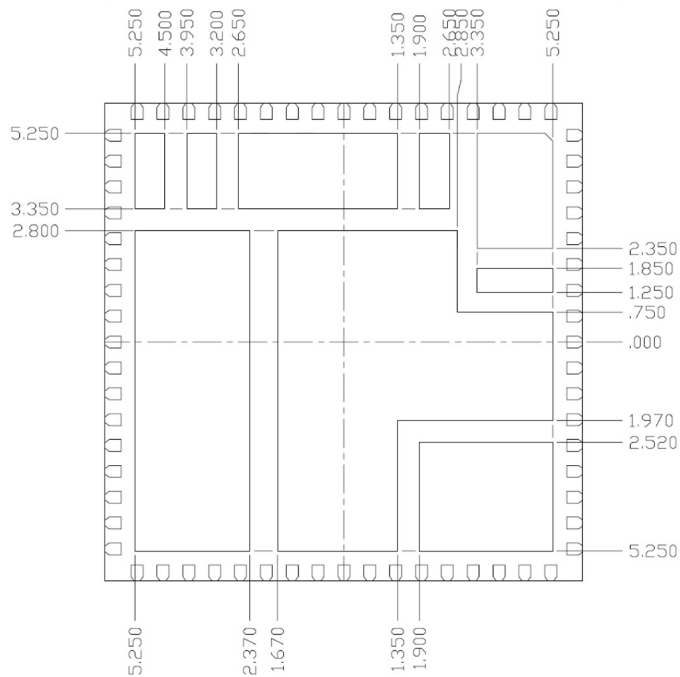

PACKAGE	68L 12x12 QFN		
REF.	MIN.	NOM.	MAX.
A	3.90	4.00	4.10
b	0.25	0.30	0.35
L	0.30	0.40	0.50
D	12.00 BSC		
D1	2.78	2.88	2.98
D2	0.65	0.75	0.85
D3	6.82	6.92	7.02
D4	4.42	4.52	4.62
D5	2.92	3.02	3.12
D6	3.90	4.00	4.10
D7	1.80	1.90	2.00
D8	1.80	1.90	2.00
D9	3.25	3.35	3.45
D10	0.65	0.75	0.85
D11	0.65	0.75	0.85
E	12.00 BSC		
E1	7.95	8.05	8.15
E2	1.80	1.90	2.00
E3	7.95	8.05	8.15
E4	1.95	2.05	2.15
E5	3.18	3.28	3.38
E6	1.80	1.90	2.00
E7	2.80	2.90	3.00
E8	0.50	0.60	0.70
E9	2.63	2.73	2.83
E10	1.80	1.90	2.00
E11	1.80	1.90	2.00
e	0.65 BSC		
n	68		
nD	17		
nE	17		

SYMBOL	COMMON DIMENSIONS			NOTE
	MIN.	NOM.	MAX.	
A1	0	0.02	0.05	
A3	0.20 REF.			

 A New Direction in Mixed-Signal		EXAR CORPORATION	
		68LD 12X12X4.0mm QFN PACKAGE OUTLINE	
Packaging Approval:		Drawing No: POD-0000059	
By: PC	Date: 07/14/14	Revision: A	Sheet: 2 OF 3

RECOMMENDED STENCIL DESIGN

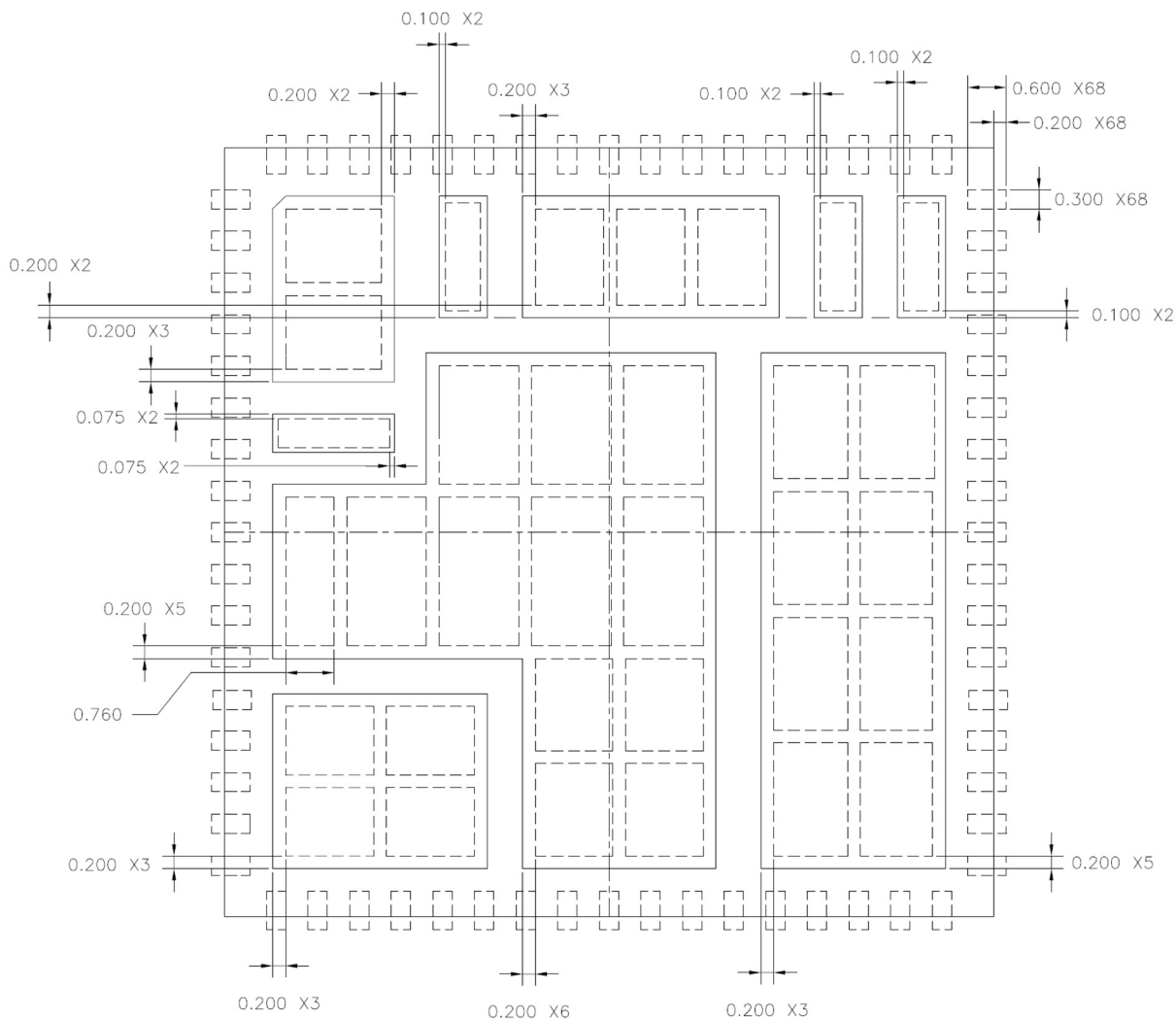

NOTE: DASH LINE REFERS TO SOLDER STENCIL OPENING.

		EXAR CORPORATION	
		QFN PACKAGE OUTLINE	
Packaging Approval:		Drawing No: POD-0000059	
By: PC	Date: 07/14/14	Revision: A	Sheet: 3 OF 3

Ordering Information

Part Number	Package	JEDEC Compliant	Operating Temperature Range	Packaging Quantity	Marking
XR79115EL-F	12x12mm QFN	Yes	-40°C to +125°C	Tray	XR79115EL YYWWF XXXXXXXX
XR79115ELTR-F				Tape and Reel	
XR79115EVB	XR79115 Evaluation Board				

“YY” = Year (last two digits)- “WW” = Work Week- “X” = Lot Number; when applicable

Revision History

Revision	Date	Description
1A	December 2014	ECN 1451-09
1B	January 2015	Corrected schematic on page 1, ECN 1504-06

For Further Assistance:

Technical Support: techsupport.exar.com

Technical Documentation: www.exar.com/techdoc

Exar Corporation Headquarters and Sales Offices

48720 Kato Road
Fremont, CA 95438 - USA

Tel.: +1 (510) 668-7000
Fax: +1 (510) 668-7001



NOTICE

EXAR Corporation reserves the right to make changes to the products contained in this publication in order to improve design, performance or reliability. EXAR Corporation assumes no responsibility for the use of any circuits described herein, conveys no license under any patent or other right, and makes no representation that the circuits are free of patent infringement. Charts and schedules contained herein are only for illustration purposes and may vary depending upon a user's specific application. While the information in this publication has been carefully checked; no responsibility, however, is assumed for inaccuracies.

EXAR Corporation does not recommend the use of any of its products in life support applications where the failure or malfunction of the product can reasonably be expected to cause failure of the life support system or to significantly affect its safety or effectiveness. Products are not authorized for use in such applications unless EXAR Corporation receives, in writing, assurances to its satisfaction that: (a) the risk of injury or damage has been minimized; (b) the user assumes all such risks; (c) potential liability of EXAR Corporation is adequately protected under the circumstances.

Reproduction, in part or whole, without the prior written consent of EXAR Corporation is prohibited.