

■ **Low Dropout Linear Regulator**

■ **Features**

- Low dropout voltage
- Load regulation: 0.2% typical
- Optimized for Low Voltage
- On-chip thermal limiting
- 1A Adjustable/Fixed Low Dropout Linear Regulator
- Three-terminal adjustable or fixed low drop out  
1.2V, 1.25V, 1.5V, 1.8V, 1.9V, 2.5V, 2.85V, 3.3V, 5V. Regulators

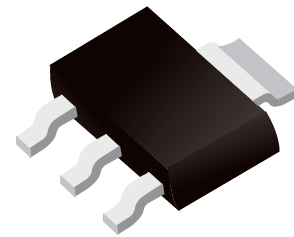

1 Adj(GND)  
2 Vout  
3 Vin

■ **Simplified outline(SOT-223)**

■ **Absolute Maximum Ratings Ta = 25°**

Parameter	Symbol	Rating	Unit
Input Voltage	V <sub>IN</sub>	18	V
Thermal Resistance.Junction- to-Ambient (Note.1)	R <sub>θJA</sub>	136	°C/W
Thermal Resistance.Junction- to-Case	R <sub>θJC</sub>	20	
Junction Temperature	T <sub>J</sub>	150	°C
Maximum Ambient Temperature	T <sub>A</sub>	140	
Lead Temperature (10 sec)		300	
Storage Temperature Range	T <sub>stg</sub>	-65 to 150	

Note.1: No air flow

■ **Block Diagram**

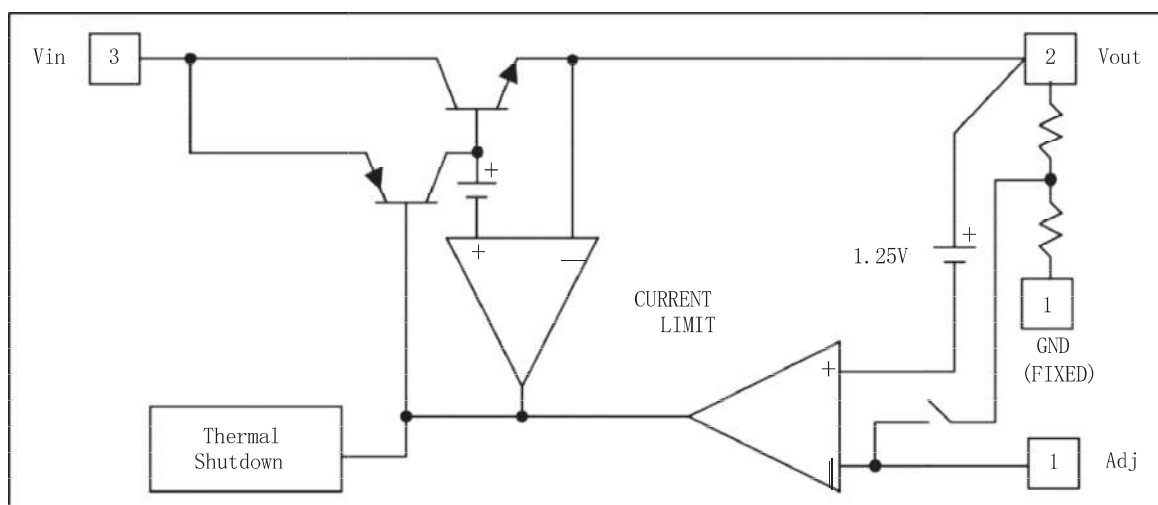

**Electrical Characteristics Ta = 25?**

Parameter	Symbol	Test Conditions		Min	Typ	Max	Unit
Reference Voltage	V <sub>REF</sub>	YFW1117-ADJ	10mA ≤ I <sub>OUT</sub> ≤ 800mA, 1.5V ≤ V <sub>IN</sub> - V <sub>OUT</sub> ≤ 12V	1.225	1.25	1.275	
Output Voltage	V <sub>OUT</sub>	YFW1117-1.2	0 ≤ I <sub>OUT</sub> ≤ 800mA, 2.6V ≤ V <sub>IN</sub> - V <sub>OUT</sub> ≤ 12V	1.175	1.2	1.225	V
		YFW1117-1.25	0 ≤ I <sub>OUT</sub> ≤ 800mA, 2.65V ≤ V <sub>IN</sub> - V <sub>OUT</sub> ≤ 12V	1.238	1.25	1.275	
		YFW1117-1.5	0 ≤ I <sub>OUT</sub> ≤ 800mA, 2.9V ≤ V <sub>IN</sub> - V <sub>OUT</sub> ≤ 12V	1.47	1.5	1.53	
		YFW1117-1.8	0 ≤ I <sub>OUT</sub> ≤ 800mA, 3.2V ≤ V <sub>IN</sub> - V <sub>OUT</sub> ≤ 12V	1.764	1.8	1.836	
		YFW1117-1.9	0 ≤ I <sub>OUT</sub> ≤ 800mA, 3.3V ≤ V <sub>IN</sub> - V <sub>OUT</sub> ≤ 12V	1.862	1.9	1.938	
		YFW1117-2.5	0 ≤ I <sub>OUT</sub> ≤ 800mA, 3.9V ≤ V <sub>IN</sub> - V <sub>OUT</sub> ≤ 12V	2.45	2.5	2.55	
		YFW1117-2.85	0 ≤ I <sub>OUT</sub> ≤ 800mA, 4.25V ≤ V <sub>IN</sub> - V <sub>OUT</sub> ≤ 12V	2.822	2.85	2.878	
		YFW1117-3.3	0 ≤ I <sub>OUT</sub> ≤ 800mA, 4.75V ≤ V <sub>IN</sub> - V <sub>OUT</sub> ≤ 12V	3.234	3.3	3.366	
Line Regulation	ΔV <sub>OUT</sub>	YFW1117-ADJ	I <sub>OUT</sub> =10mA, 1.5V ≤ V <sub>IN</sub> -V <sub>OUT</sub> ≤ 12V		0.035	0.2	%
		YFW1117-1.2	I <sub>OUT</sub> =10mA, 2.6V ≤ V <sub>IN</sub> -V <sub>OUT</sub> ≤ 12V		9	12	mV
		YFW1117-1.25	I <sub>OUT</sub> =10mA, 2.65V ≤ V <sub>IN</sub> -V <sub>OUT</sub> ≤ 12V				
		YFW1117-1.5	I <sub>OUT</sub> =10mA, 2.9V ≤ V <sub>IN</sub> -V <sub>OUT</sub> ≤ 12V				
		YFW1117-1.8	I <sub>OUT</sub> =10mA, 3.2V ≤ V <sub>IN</sub> -V <sub>OUT</sub> ≤ 12V				
		YFW1117-1.9	I <sub>OUT</sub> =10mA, 3.3V ≤ V <sub>IN</sub> -V <sub>OUT</sub> ≤ 12V				
		YFW1117-2.5	I <sub>OUT</sub> =10mA, 3.9V ≤ V <sub>IN</sub> -V <sub>OUT</sub> ≤ 12V				
		YFW1117-2.85	I <sub>OUT</sub> =10mA, 4.25V ≤ V <sub>IN</sub> -V <sub>OUT</sub> ≤ 12V				
		YFW1117-3.3	I <sub>OUT</sub> =10mA, 4.75V ≤ V <sub>IN</sub> -V <sub>OUT</sub> ≤ 12V				
		YFW1117-5.0	I <sub>OUT</sub> =10mA, 6.5V ≤ V <sub>IN</sub> -V <sub>OUT</sub> ≤ 12V				
Load Regulation	ΔV <sub>OUT</sub>	YFW1117-ADJ	V <sub>IN</sub> -V <sub>OUT</sub> =3V, 10mA ≤ I <sub>OUT</sub> ≤ 800mA				
		YFW1117-1.2	V <sub>IN</sub> =2.6V, 10mA ≤ I <sub>OUT</sub> ≤ 800mA		3	10	mV
		YFW1117-1.25	V <sub>IN</sub> =2.65V, 10mA ≤ I <sub>OUT</sub> ≤ 800mA				
		YFW1117-1.5	V <sub>IN</sub> =2.9V, 10mA ≤ I <sub>OUT</sub> ≤ 800mA				
		YFW1117-1.8	V <sub>IN</sub> =3.2V, 10mA ≤ I <sub>OUT</sub> ≤ 800mA				
		YFW1117-1.9	V <sub>IN</sub> =3.3V, 10mA ≤ I <sub>OUT</sub> ≤ 800mA				
		YFW1117-2.5	V <sub>IN</sub> =3.9V, 10mA ≤ I <sub>OUT</sub> ≤ 800mA				
		YFW1117-2.85	V <sub>IN</sub> =4.25V, 10mA ≤ I <sub>OUT</sub> ≤ 800mA				
		YFW1117-3.3	V <sub>IN</sub> =4.75V, 10mA ≤ I <sub>OUT</sub> ≤ 800mA				
		YFW1117-5.0	V <sub>IN</sub> =6.5V, 10mA ≤ I <sub>OUT</sub> ≤ 800mA				
Dropout Voltage	V <sub>IN</sub> -V <sub>OUT</sub>	YFW1117-XXX	ΔV <sub>OUT</sub> , ΔV <sub>REF</sub> =1%, I <sub>OUT</sub> =0.1A				
		YFW1117-XXX	ΔV <sub>OUT</sub> , ΔV <sub>REF</sub> =1%, I <sub>OUT</sub> =0.5A		1.18	1.25	
		YFW1117-XXX	ΔV <sub>OUT</sub> , ΔV <sub>REF</sub> =1%, I <sub>OUT</sub> =0.8A		1.26	1.3	
Current Limit	I <sub>limit</sub>	YFW1117-XXX	V <sub>IN</sub> -V <sub>OUT</sub> =5V, T <sub>J</sub> =25?	1.25	1.4	1.6	A
		YFW1117-XXX	YFW1117-ADJ		5	10	mA
Adjust Pin Current	I <sub>ADJ</sub>				55	120	uA
Adjust Pin Current Change	I <sub>Change</sub>				0.2		

■ Electrical Characteristics Ta = 25°

Quiescent Current	I <sub>Q</sub>	YFW1117-1.2	V <sub>in</sub> -V <sub>out</sub> =1.25V		4	8	mA
		YFW1117-1.25					
		YFW1117-1.5					
		YFW1117-1.8					
		YFW1117-1.9					
		YFW1117-2.5					
		YFW1117-2.85					
		YFW1117-3.3					
		YFW1117-5.0					

■ Typical Applications

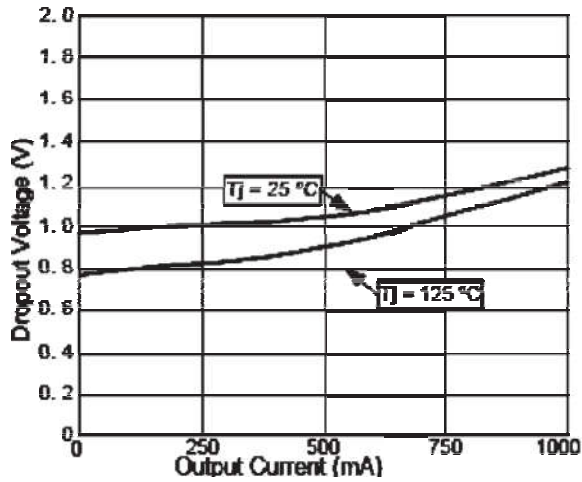

Fig.1 Dropout Voltage vs Output Current

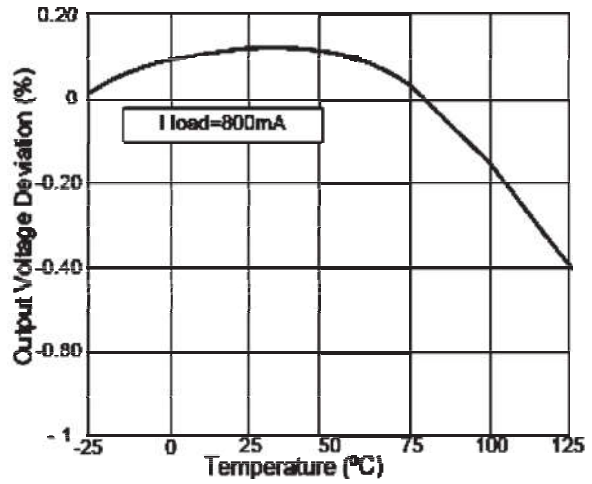

Fig.2 Load Regulation vs Temperature

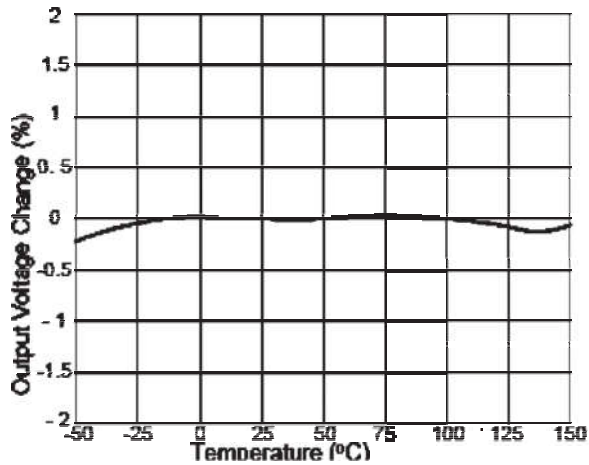

Fig.3 Percent Change in Output Voltage vs Temperature

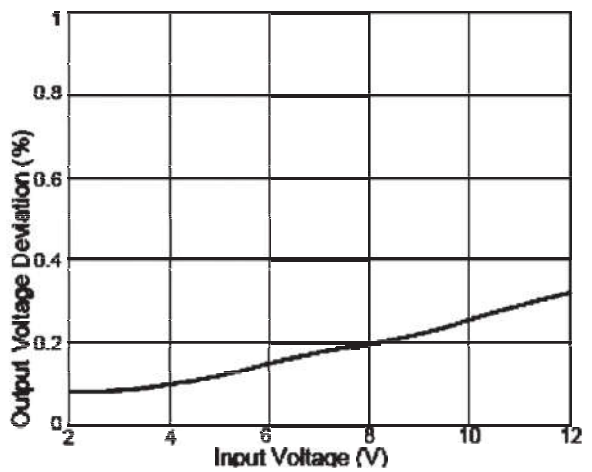

Fig.4 Line Regulation

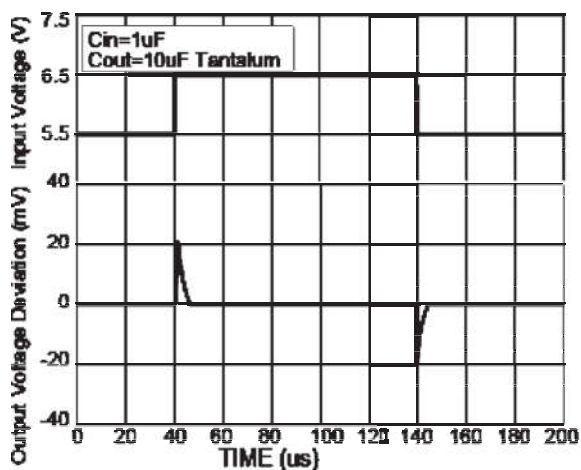

Fig.5 Line Transient Response

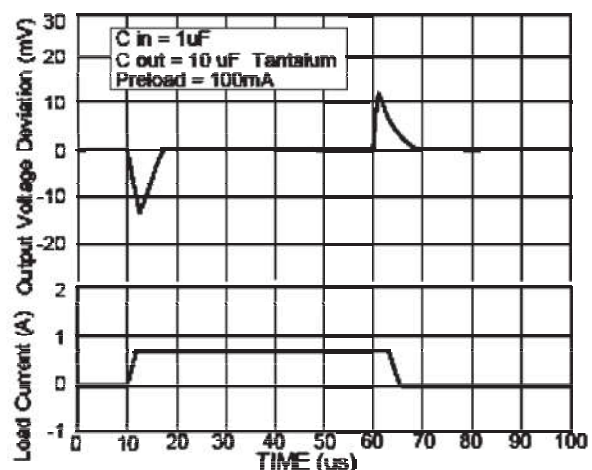
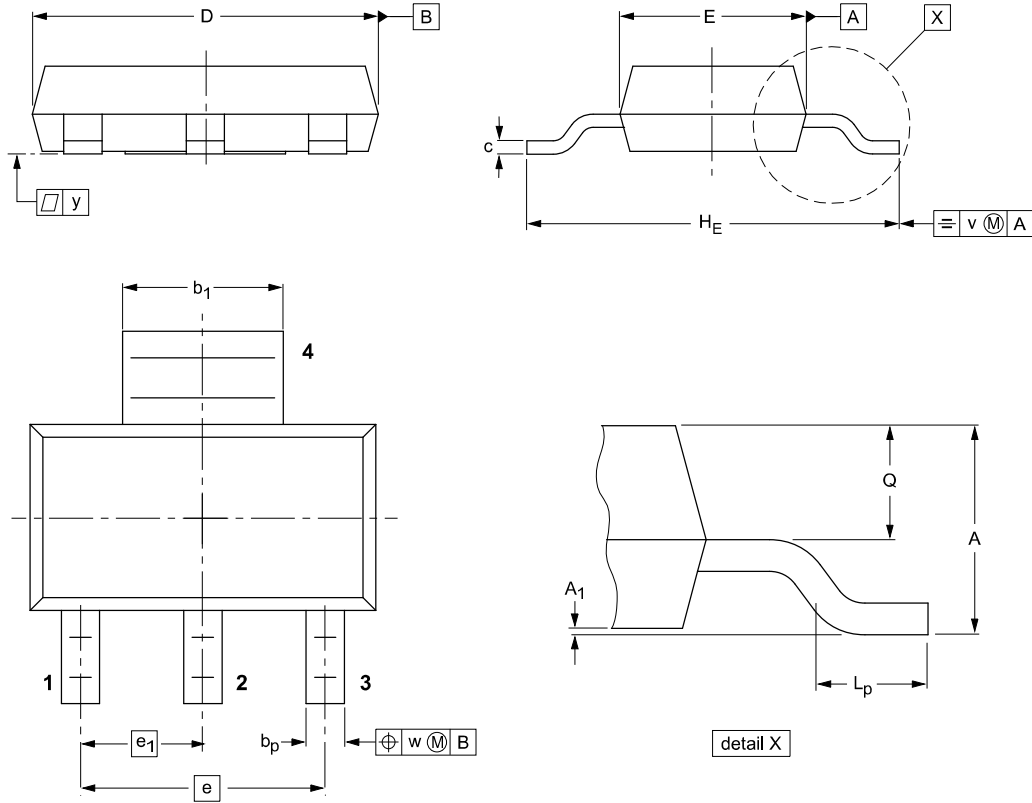

Fig.6 Load Transient Response

Package Outline

SOT-223



- 1.GND/ADJ
- 2.Output
- 3.Input
- 4.Output

**DIMENSIONS (mm are the original dimensions)**

UNIT	A	A <sub>1</sub>	b <sub>p</sub>	b <sub>1</sub>	c	D	E	e	e <sub>1</sub>	H <sub>E</sub>	L <sub>p</sub>	Q	v	w	y
mm	1.8 1.5	0.10 0.01	0.80 0.60	3.1 2.9	0.32 0.22	6.7 6.3	3.7 3.3	4.6	2.3	7.3 6.7	1.1 0.7	0.95 0.85	0.2	0.1	0.1

Summary of Packing Options

Package	Package Description	Packing Quantity	Industry Standard
SOT-223	Tape/Reel,13"reel	2500	EIA-481-1