

P-Channel Enhancement Mode Field Effect Transistor

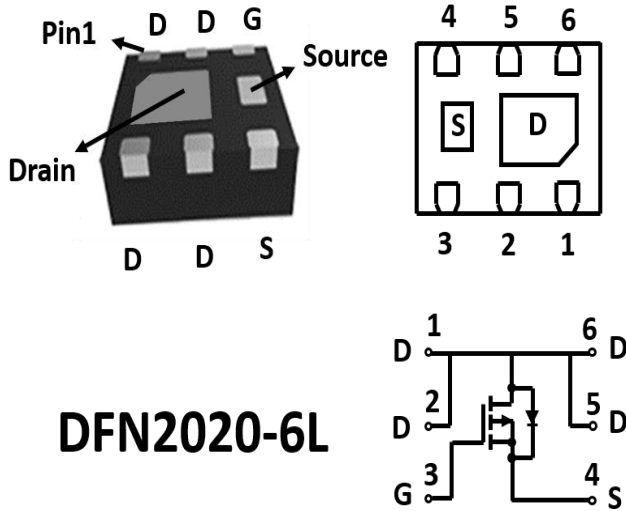

DFN2020-6L

Product Summary

- V_{DS} -16V
- I_D -8A
- $R_{DS(ON)}$ (at $V_{GS}=-4.5V$) <25 mohm
- $R_{DS(ON)}$ (at $V_{GS}=-2.5V$) <32 mohm
- $R_{DS(ON)}$ (at $V_{GS}=-1.8V$) <52 mohm

General Description

- Trench Power LV MOSFET technology
- Low $R_{DS(ON)}$
- Low Gate Charge

Applications

- Battery charge
- Load switching in Cellular handset
- Ultraportable applications

■ Absolute Maximum Ratings ($T_A=25^\circ C$ unless otherwise noted)

Parameter	Symbol	Maximum	Unit
Drain-source Voltage	V_{DS}	-16	V
Gate-source Voltage	V_{GS}	± 10	V
Drain Current	I_D	$T_A=25^\circ C$	-8
		$T_A=70^\circ C$	-6.4
Pulsed Drain Current ^A	I_{DM}	-32	A
Total Power Dissipation @ $T_A=25^\circ C$	P_D	2.5	W
Thermal Resistance Junction-to-Ambient ^B	$R_{\theta JA}$	50	°C/W
Thermal Resistance Junction-to-Case	$R_{\theta JC}$	15	
Junction and Storage Temperature Range	T_J, T_{STG}	-55~+150	°C

■ Ordering Information (Example)

PREFERRED P/N	PACKING CODE	Marking	MINIMUM PACKAGE(pcs)	INNER BOX QUANTITY(pcs)	OUTER CARTON QUANTITY(pcs)	DELIVERY MODE
YJQ4666C	F2	..G66C	3000	15000	60000	7" reel



YJQ4666C

■ Electrical Characteristics (T_J=25°C unless otherwise noted)

Parameter	Symbol	Conditions	Min	Typ	Max	Units
Static Parameter						
Drain-Source Breakdown Voltage	BV _{DSS}	V _{GS} =0V, I _D =-250μA	-16			V
Zero Gate Voltage Drain Current	I _{DSS}	V _{DS} =-16V, V _{GS} =0V, T _C =25°C			-1	μA
Gate-Body Leakage Current	I _{GSS}	V _{GS} = ±10V, V _{DS} =0V			±100	nA
Gate Threshold Voltage	V _{GS(th)}	V _{DS} = V _{GS} , I _D =-250μA	-0.4	-0.62	-1.0	V
Static Drain-Source On-Resistance	R _{DS(ON)}	V _{GS} = -4.5V, I _D =-8A		20	25	mΩ
		V _{GS} = -2.5V, I _D =-5.6A		26	32	
		V _{GS} = -1.8V, I _D =-2A		35	52	
Diode Forward Voltage	V _{SD}	I _S =-8A, V _{GS} =0V		-0.7	-1	V
Maximum Body-Diode Continuous Current	I _S				-8	A
Dynamic Parameters						
Input Capacitance	C _{iss}	V _{DS} =-10V, V _{GS} =0V, f=1MHZ		990		pF
Output Capacitance	C _{oss}			168		
Reverse Transfer Capacitance	C _{rss}			107		
Switching Parameters						
Total Gate Charge	Q _g	V _{GS} =-4.5V, V _{DS} =-10V, I _D =-8A		8.6		nC
Gate Source Charge	Q _{gs}			1.6		
Gate Drain Charge	Q _{gd}			2.2		
Turn-on Delay Time	t _{D(on)}	V _{GS} =-4.5V, V _{DD} =-10V, I _D =-1A, R _{GEN} =2.5Ω		12		ns
Turn-on Rise Time	t _r			54		
Turn-off Delay Time	t _{D(off)}			15		
Turn-off Fall Time	t _f			9		

A. Pulse Test: Pulse Width ≤ 300μs, Duty cycle ≤ 2%.

B. R_{θJA} is the sum of the junction-to-case and case-to-ambient thermal resistance, where the case thermal reference is defined as the solder mounting surface of the drain pins. R_{θJC} is guaranteed by design, while R_{θJA} is determined by the board design. The maximum rating presented here is based on mounting on a 1 in 2 pad of 2oz copper.



■ Typical Performance Characteristics

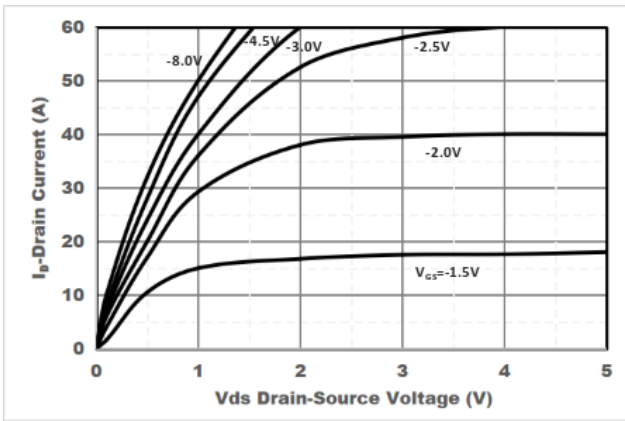

Figure1. Output Characteristics

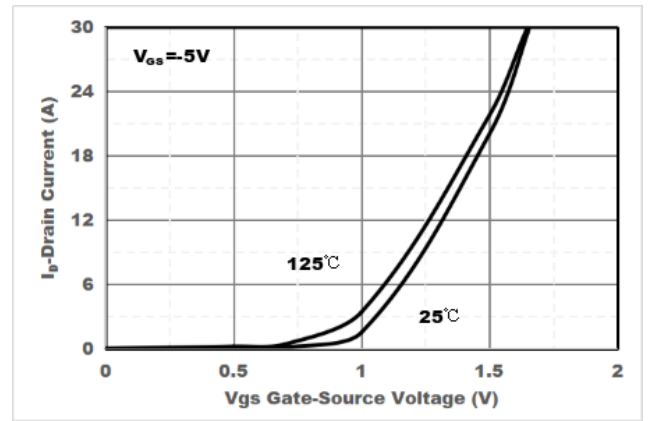

Figure2. Transfer Characteristics

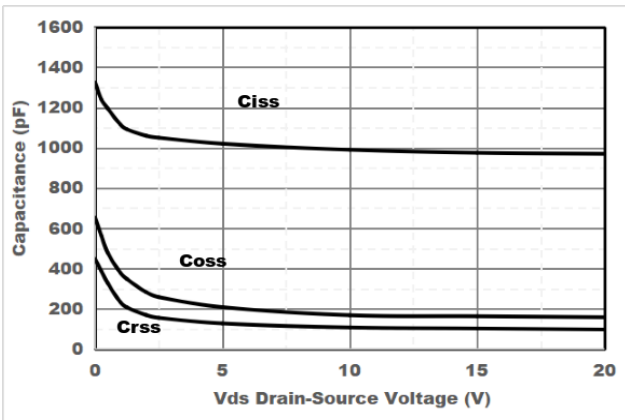

Figure3. Capacitance Characteristics

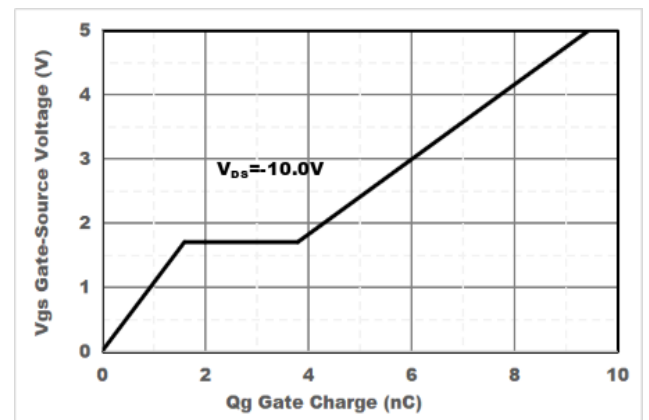

Figure4. Gate Charge

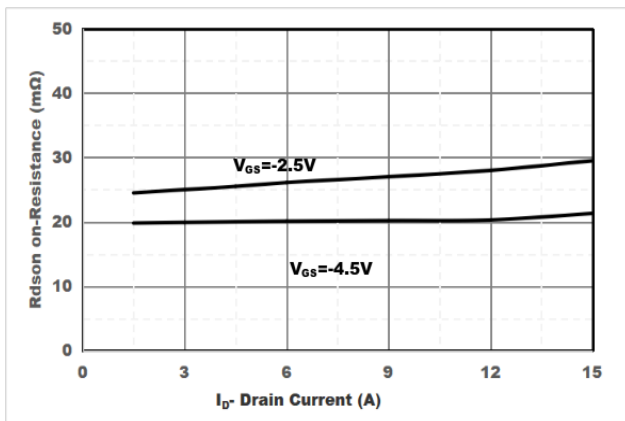

Figure5. Drain-Source on Resistance

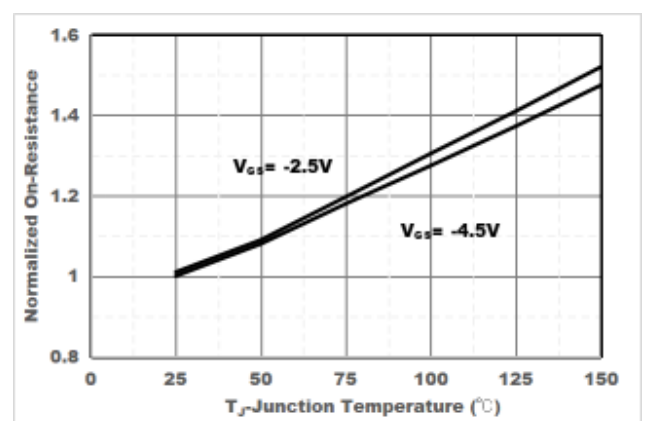

Figure6. Drain-Source on Resistance

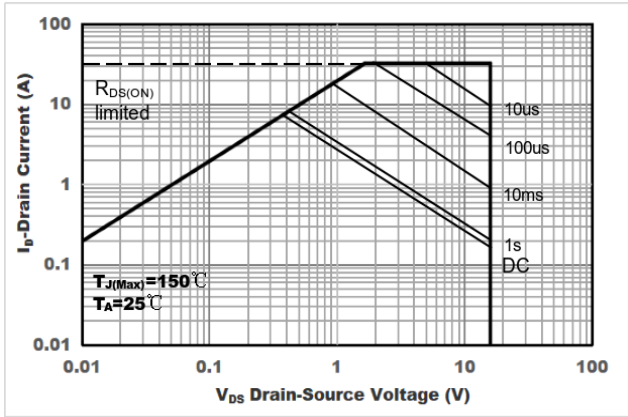

Figure7. Safe Operation Area

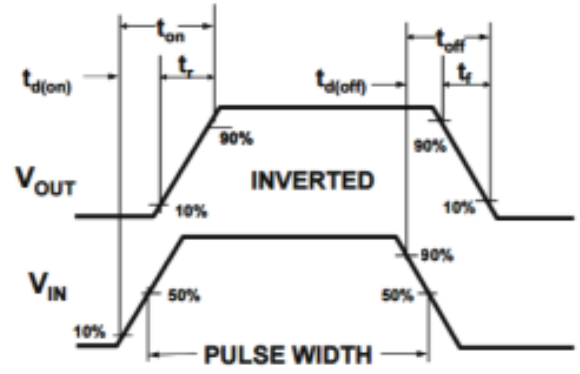
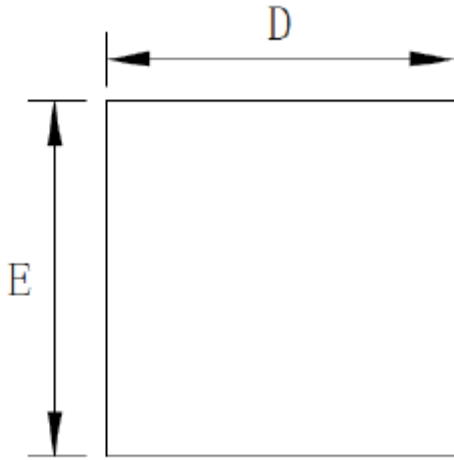
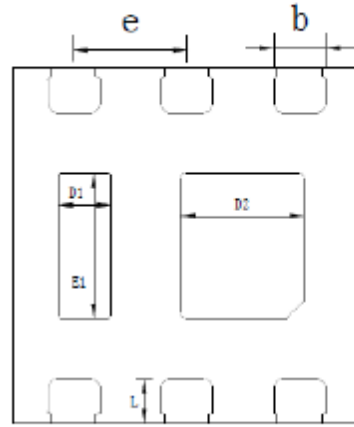

Figure8. Switching wave

■ DFN2020-6L Package information



Top View
【顶视图】



Bottom View
【背视图】

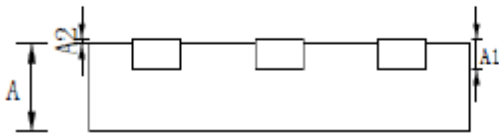

Side View
【侧视图】

SYMBOL	MILLIMETER		
	MIN	NOM	MAX
A	0.70	0.75	0.80
A1		0.15REF	
A2	0.00	0.02	0.05
L	0.20	0.25	0.30
b	0.25	0.30	0.35
D	1.95	2.00	2.05
E	1.95	2.00	2.05
e		0.65BSC	
D2	0.61	0.71	0.81
D1	0.20	0.30	0.40
E1	0.71	0.81	0.91

备注: A1/e 不监控



YJQ4666C

Disclaimer

The information presented in this document is for reference only. Yangzhou Yangjie Electronic Technology Co., Ltd. reserves the right to make changes without notice for the specification of the products displayed herein to improve reliability, function or design or otherwise.

The product listed herein is designed to be used with ordinary electronic equipment or devices, and not designed to be used with equipment or devices which require high level of reliability and the malfunction of which would directly endanger human life (such as medical instruments, transportation equipment, aerospace machinery, nuclear-reactor controllers, fuel controllers and other safety devices), Yangjie or anyone on its behalf, assumes no responsibility or liability for any damages resulting from such improper use of sale.

This publication supersedes & replaces all information previously supplied. For additional information, please visit our website [http:// www.21yangjie.com](http://www.21yangjie.com) , or consult your nearest Yangjie's sales office for further assistance.