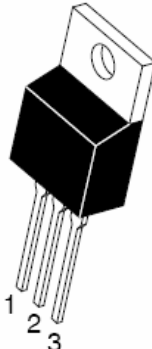
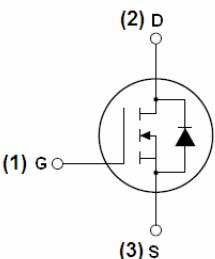

### N-Channel Enhancement Mode Power MOSFET

<p><b>General Description</b></p> <p>The YMP230N55 uses advanced trench technology and design to provide excellent <math>R_{DS(ON)}</math> with low gate charge. This device is suitable for use in PWM, load switching and general purpose applications.</p> <p><b>Features</b></p> <ul style="list-style-type: none"> <li>● <math>V_{DS}=55V</math>; <math>I_D=230A@ V_{GS}=10V</math>; <math>R_{DS(ON)} &lt; 3 m\Omega @ V_{GS} = 10V</math></li> <li>● Special process technology for high ESD capability</li> <li>● Special designed for Convertors and power controls</li> <li>● High density cell design for ultra low Rdson</li> <li>● Fully characterized Avalanche voltage and current</li> <li>● Good stability and uniformity with high <math>E_{AS}</math></li> <li>● Excellent package for good heat dissipation</li> </ul> <p><b>Application</b></p> <ul style="list-style-type: none"> <li>● Power switching application</li> <li>● Hard Switched and High Frequency Circuits</li> <li>● Uninterruptible Power Supply</li> </ul>	<p><b>Product Summary</b></p> <table border="1" style="width: 100%; border-collapse: collapse; margin-bottom: 10px;"> <tr> <td><math>BV_{DSS}</math> typ.</td> <td>55</td> <td>V</td> </tr> <tr> <td rowspan="2"><math>R_{DS(ON)}</math> typ.</td> <td>2</td> <td>m<math>\Omega</math></td> </tr> <tr> <td>max.</td> <td>3</td> </tr> <tr> <td><math>I_D</math></td> <td>230</td> <td>A</td> </tr> </table> <div style="display: flex; justify-content: space-around; align-items: center;"> <div style="text-align: center;">  <p>TO-220-3L top view</p> </div> <div style="text-align: center;"> <p style="color: red; font-weight: bold;">100% UIS TESTED!</p>  <p>Schematic diagram</p> </div> </div>	$BV_{DSS}$ typ.	55	V	$R_{DS(ON)}$ typ.	2	m $\Omega$	max.	3	$I_D$	230	A
$BV_{DSS}$ typ.	55	V										
$R_{DS(ON)}$ typ.	2	m $\Omega$										
	max.	3										
$I_D$	230	A										

### Package Marking And Ordering Information

Device Marking	Device	Device Package	Reel Size	Tape width	Quantity
YMP230N55	YMP230N55	TO-220-3L	-	-	-

**Table 1. Absolute Maximum Ratings (TA=25°C)**

Parameter	Symbol	Value	Unit
Drain-Source Voltage ( $V_{GS}=0V$ )	$V_{DS}$	55	V
Gate-Source Voltage ( $V_{DS}=0V$ )	$V_{GS}$	$\pm 25$	V
Drain Current (DC) at $T_c=25^\circ C$	$I_{D(DC)}$	230	A
Drain Current (DC) at $T_c=100^\circ C$	$I_{D(DC)}$	170	A
Drain Current-Continuous@ Current-Pulsed (Note 1)	$I_{DM(pluse)}$	900	A
Maximum Power Dissipation( $T_c=25^\circ C$ )	$P_D$	300	W
Derating factor		1.33	W/ $^\circ C$
Single pulse avalanche energy (Note 2)	$E_{AS}$	2000	mJ
Operating Junction and Storage Temperature Range	$T_J, T_{STG}$	-55 To 175	$^\circ C$

**Notes** 1.Repetitive Rating: Pulse width limited by maximum junction temperature

2.EAS condition:  $T_J=25^\circ C, V_{DD}=28V, V_G=10V, L=1mH, R_g=25\Omega$ ;

**Table 2. Thermal Characteristic**

Parameter	Symbol	Value	Unit
Thermal Resistance, Junction-to-Case (Note2)	$R_{thJC}$	0.75	$^{\circ}C/W$

**Table 3. Electrical Characteristics (TA=25 $^{\circ}C$  unless otherwise noted)**

Parameter	Symbol	Condition	Min	Typ	Max	Unit
<b>Off Characteristics</b>						
Drain-Source Breakdown Voltage	$BV_{DSS}$	$V_{GS}=0V, I_D=250\mu A$	55			V
Zero Gate Voltage Drain Current(Tc=25 $^{\circ}C$ )	$I_{DSS}$	$V_{DS}=-24V, V_{GS}=0V$			1	$\mu A$
Gate-Body Leakage Current	$I_{DSS}$	$V_{GS}=\pm 25V, V_{DS}=0V$			$\pm 100$	$\mu A$
<b>On Characteristics (Note 3)</b>						
Gate Threshold Voltage	$V_{GS(th)}$	$V_{DS}=10V, I_D=250\mu A$	2	-	4	V
Drain-Source On-State Resistance	$R_{DS(on)}$	$V_{GS}=10V, I_D=95A$		2	3	m $\Omega$
<b>Dynamic Characteristics</b>						
Forward Transconductance	$g_{FS}$	$V_{DS}=25V, I_D=60A$	106			S
Input Capacitance	$C_{iss}$	$V_{DS}=30V, V_{GS}=0V,$ $F=1.0MHz$		7360		PF
Output Capacitance	$C_{oss}$			1680		PF
Reverse Transfer Capacitance	$C_{rss}$			240		PF
Total Gate Charge	$Q_g$	$V_{DS}=48V, I_D=95A,$ $V_{GS}=10V$		160		nC
Gate-Source Charge	$Q_{gs}$			35		nC
Gate-Drain Charge	$Q_{gd}$			42		nC
<b>Switching times</b>						
Turn-on Delay Time	$t_{d(on)}$	$V_{DD}=30V, I_D=1A, R_L=30\Omega$		17	33	nS
Turn-on Rise Time	$t_r$			21	37	nS
Turn-Off Delay Time	$t_{d(off)}$	$V_{GS}=10V, R_G=3\Omega$ $R_D=0.21\Omega$		72	148	nS
Turn-Off Fall Time	$t_f$			26	78	nS
<b>Source- Drain Diode Characteristics</b>						
Source-drain current(Body Diode)	$I_{SD}$				95	A
Forward on voltage <sup>(Note 3)</sup>	$V_{SD}$	$T_j=25^{\circ}C, I_{SD}=20A, V_{GS}=0V$		0.8	1.3	V
Reverse Recovery Time <sup>(Note 1)</sup>	$t_{rr}$	$T_j=25^{\circ}C, I_F=40A, di/dt=100A/\mu s$		74		nS
Reverse Recovery Charge	$Q_{rr}$			140		nC
Forward Turn-on Time	$t_{on}$	Intrinsic turn-on time is negligible(turn-on is dominated by $L_S+L_D$ )				

Notes 3. Pulse Test: Pulse Width  $\leq 300\mu s$ , Duty Cycle  $\leq 2\%$ ,  $R_G=25\Omega$ , Starting  $T_j=25^{\circ}C$

### Test circuit

#### 1) $E_{AS}$ test Circuits

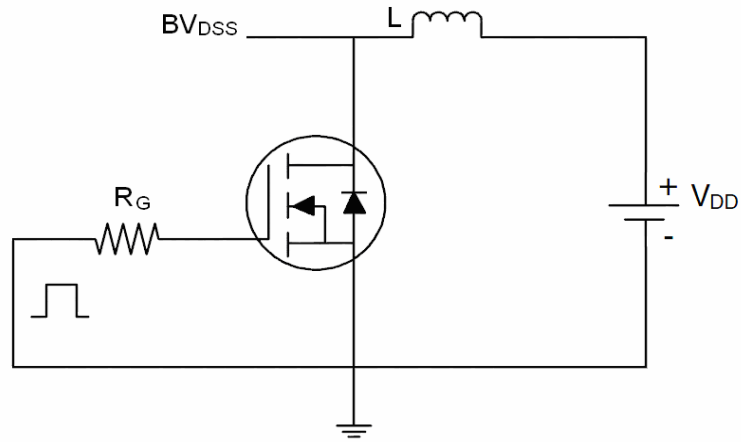

#### 2) Gate charge test Circuit:

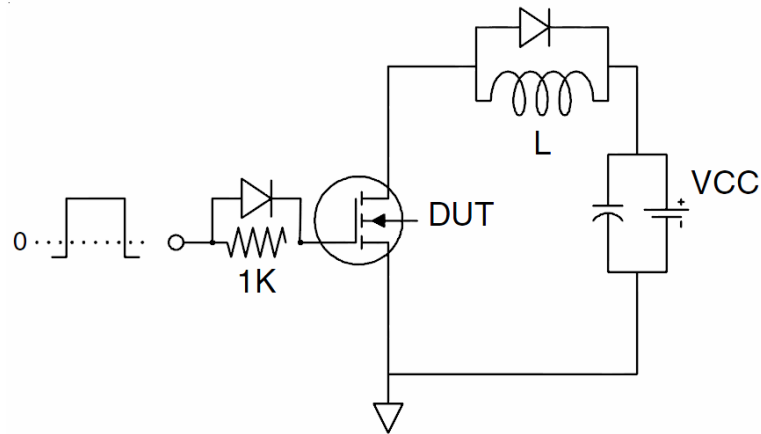

#### 3) Switch Time Test Circuit:

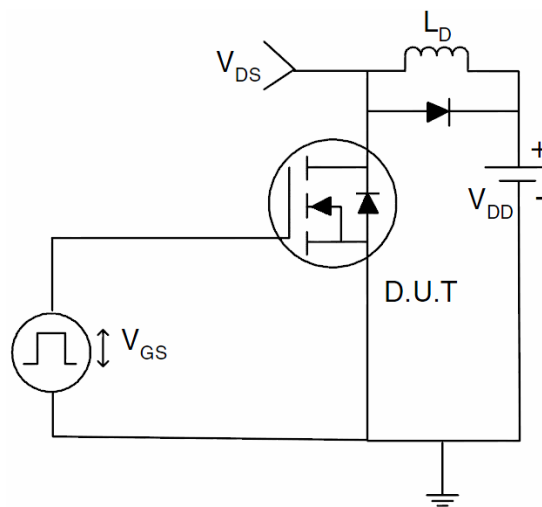

### Typical Characteristics

**Safe Operation Area**

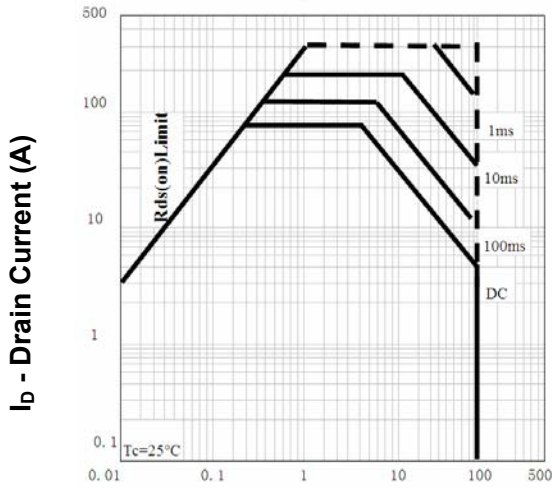

$V_{DS}$  - Drain-Source Voltage (V)

**Drain Current**

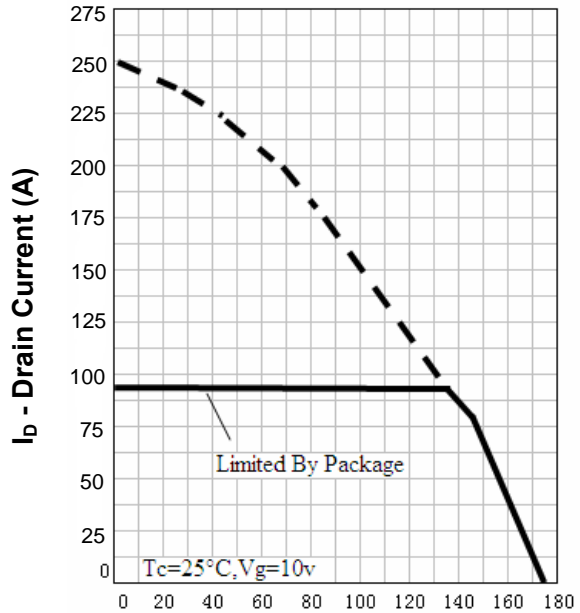

$T_J$  - Junction Temperature ( $^\circ\text{C}$ )

**Thermal Transient Impedance**

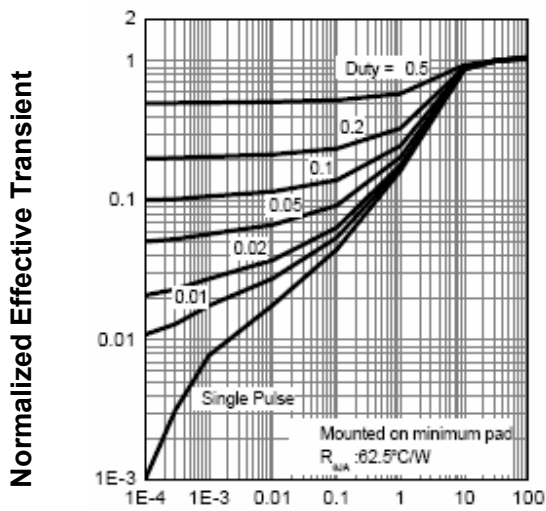

Square Wave Pulse Duration (sec)

### Typical Characteristics (Cont.)

**Output Characteristics**

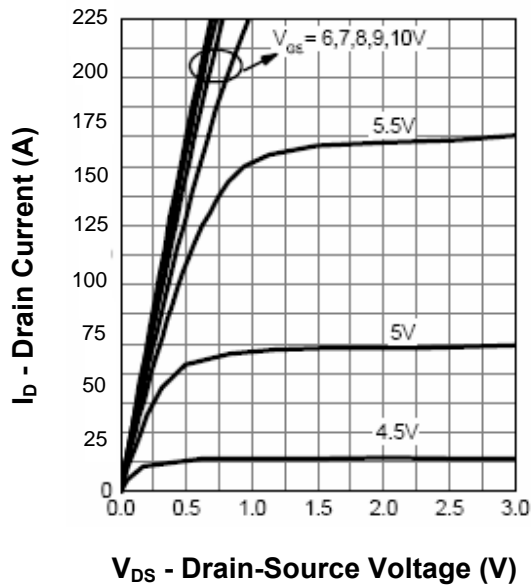

**Drain-Source On Resistance**

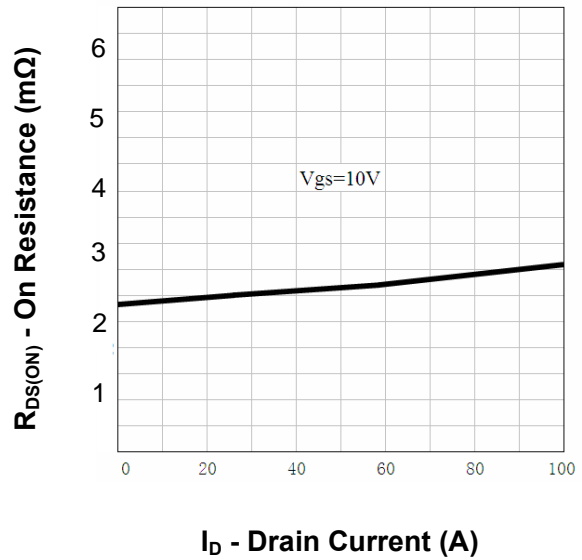

**Drain-Source On Resistance**

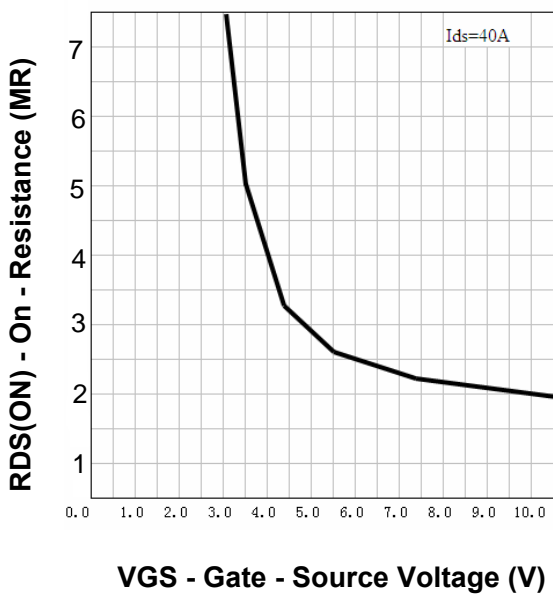

**Gate Threshold Voltage**

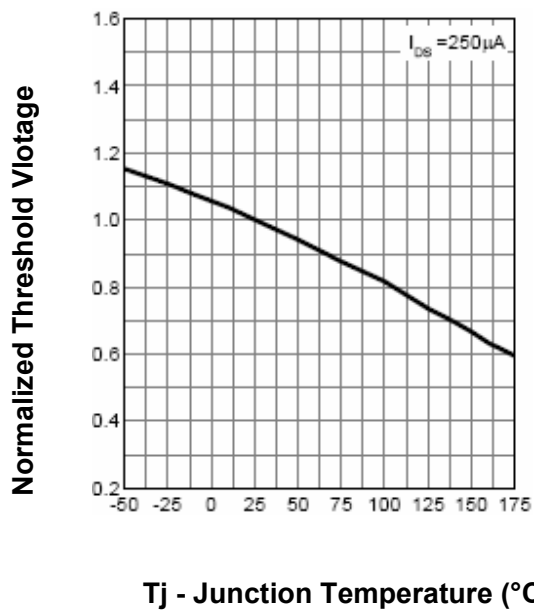

### Typical Characteristics (Cont.)

**Drain-Source On Resistance**

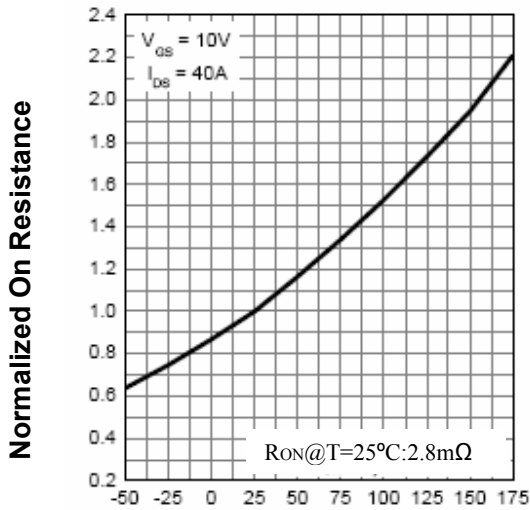

$T_j$  - Junction Temperature ( $^{\circ}C$ )

**Source-Drain Diode Forward**

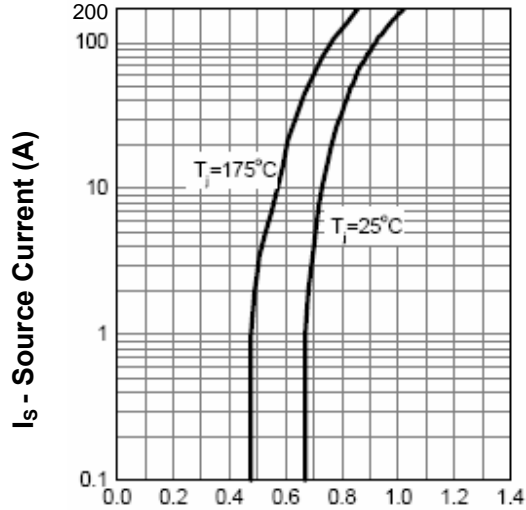

$V_{SD}$  - Source-Drain Voltage (V)

**Capacitance**

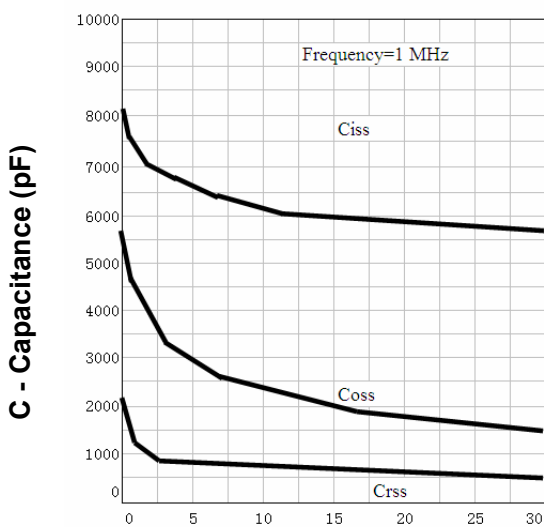

$V_{DS}$  - Drain-Source Voltage (V)

**Gate Charge**

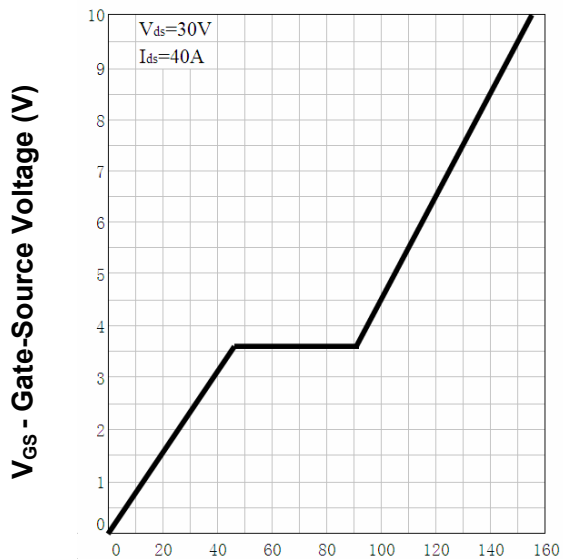

$Q_G$  - Gate Charge (nC)