

STANDARD CHARACTER MODULES

YMS204-01

20CHAR x 4LINE
1/16DUTY, 1/5BIAS

1 EXTERNAL DIMENSION AND DISPLAY PATTERN

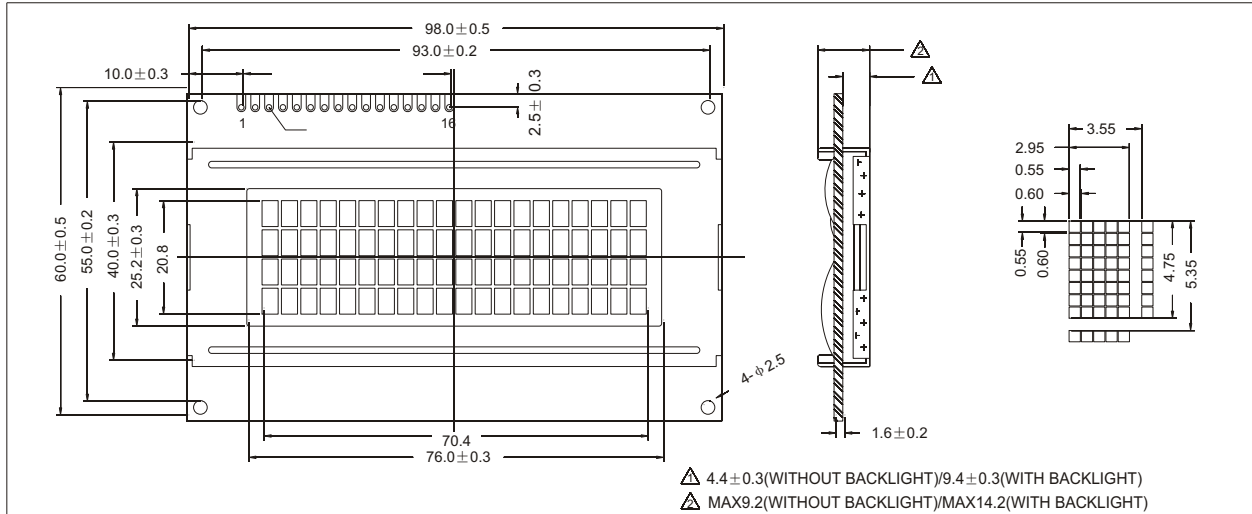

2 MECHANICAL DATA

ITEM	SPECIFICATION	UNIT
Module Size(WXHXH)	98.0 x 60.0 x 9.2/14.2	mm
Viewing Area(WXH)	76.0 x 25.2	mm
Character Font(WXH)	5 x 7 with Cursor	dots
Character Size(WXH)	2.95 x 4.75	mm
Character Pitch(WXH)	3.55 x 5.35	mm
Dot Size(WXH)	0.55 x 0.55	mm

5 ABSOLUTE MAXIMUM RATINGS

PARAMETER	SYMBOL	MIN.	MAX.	UNIT
Supply Voltage Logic	$V_{CC}-V_{ES}$	-0.3	7.0	V
Supply Voltage Driver	$V_{CC}-V_{EE}$	$V_{CC}+0.3$	$V_{CC}-13.5$	V
Input Voltage	V_{IN}	-0.3	$V_{CC}+0.3$	V
Operating Temp.	See page 9			
Storage Temp.				

3 PIN CONFIGURATION

PIN	SYMBOL	SIGNAL DESCRIPTION
1	V_{SS}	GND(0V)
2	V_{DD}	Power Supply(5V)
3	V_{EE}	Supply Voltage LCD Driver
4	RS	Register Select-LOW=Instruction,HIGH=Data
5	R/W	Read/Write LOW=MPU to LCM,HIGH=LCM to MPU
6	E	Eable R/W=LOW:Data are talking over at falling edge R/W=HIGH:Data can be read at E=1
7 to 14	DB_7 to DB_7	Data Bus-Software Selectable 4 or 8bit Mode
15	A	Anode of LED Unit
16	K	Cathode of LED Unit

6 ELECTRICAL CHARACTERISTICS(Ta=25 °C)

ITEM	SYMBOL	CONDITION	SPEC.VALUE			UNIT
			MIN.	TYP.	MAX.	
Supply Voltage (Logic)	$V_{CC}-V_{ES}$		4.5	5.0	5.5	V
Supply Current (Logic)	I_{DD}	$V_{CC}=5V$	-	2.0	3.0	mA
Input Voltage	"HIGH"	V_{IH}	-	2.2	-	V_{DD}
	"LOW"	V_{IL}	-	-0.3	-	0.6
Output Voltage	"HIGH"	V_{OH}	$I_{OL}=0.2mA$	2.4	-	V
	"LOW"	V_{OL}	$I_{OL}=1.2mA$	-	-	0.4
LCD Operating Voltage	$V_{CC}-V_{EE}$	$V_{CC}=5V$	4.5	4.7	5.0	V
Supply Current LCD Drive	I_{EE}	Ta=25 °C	-	1.0	2.2	mA

Note(1): () Value is high Reliability type
Note(2): Electro-Optical Characteristics: See page 6.

4 BLOCK DIAGRAM

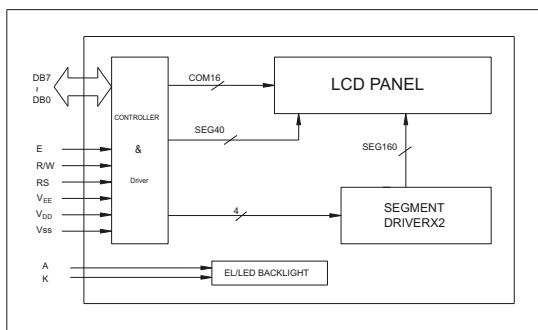

7 BACKLIGHTING CHARACTERISTICS(Ta=25 °C)

ITEM	SYMBOL	CONDITION	MIN.	TYP.	MAX.	UNIT
Supply Voltage	V_{LED}	-	3.8	4.0	4.2	V
Power Consumption	P_{LED}	IF=180mA	-	720	-	mW
Luminous	I_V	IF=180mA	-	-	-	cd/m ²