

Solar LED Driver YX8018

Japanese PDF to English PDF by Jonovid 2016

Features: high efficiency: 80-90% less parts:
 inductor 1 only by low-voltage battery protection features current adjustment package:
 TO-94 YX8019 is one or two 1.25 V Rechargeable battery LED to stable on.
 LED lights, automatic switch between in sun light falls on the solar cells and
 rechargeable batteries to charge at night and charge the rechargeable batteries.
 Solar LED driver YX8018

PIN number	name	function
1	LX	Switched Lane
2	GND	GND
3	CE	Negative electrode of solar batteries, charging control / EN
4	VDD	Solar cell

1 (1.25V rechargeable batteries 1 applied)

- LED (white, blue, green)

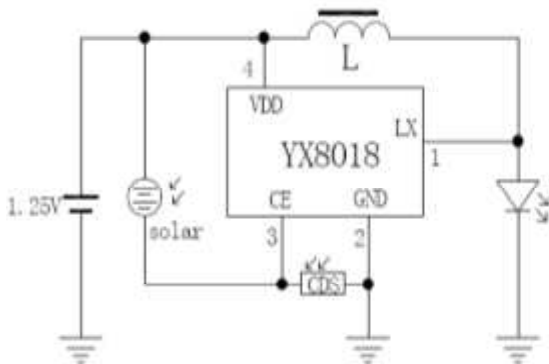

Figure 1-1 CDS, use

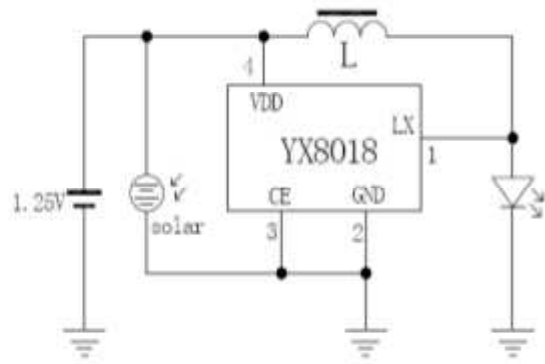
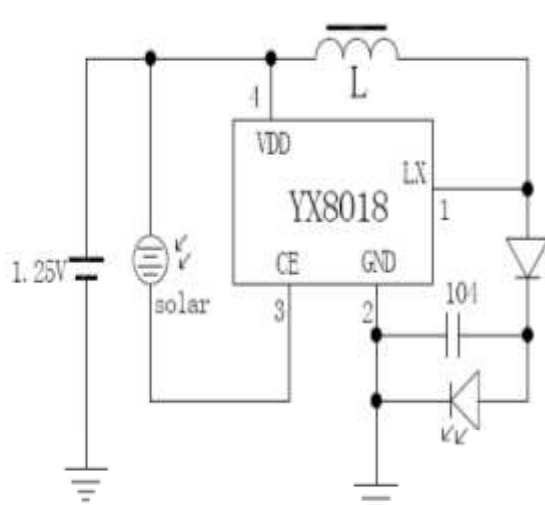
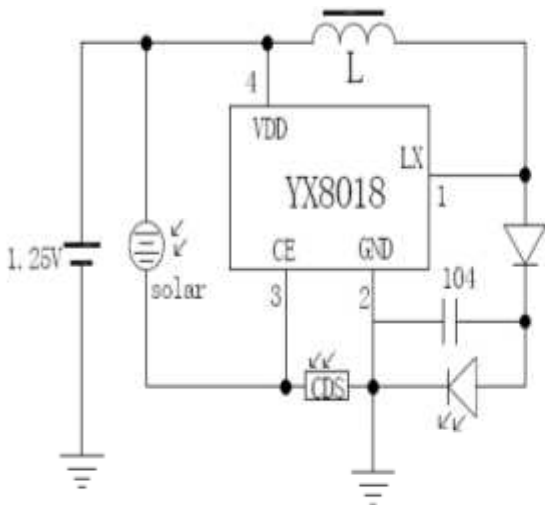

Figure 1-2 without using CDS

- 7 color LED IL ILMI.



1.25V			
Inductor	package	LED	current
560uH	0307	LEDx1 pieces	3.0mA
220uH	0307	LEDx1 pieces	7.0mA
150uH	0307	LEDx1 pieces	10mA
82uH	0307	LEDx1 pieces	15mA
68uH	0307	LEDx1 pieces	21mA
47uH	0410	LEDx2 pieces	30mA

Application 2 (1.25V rechargeable battery x2 pieces)

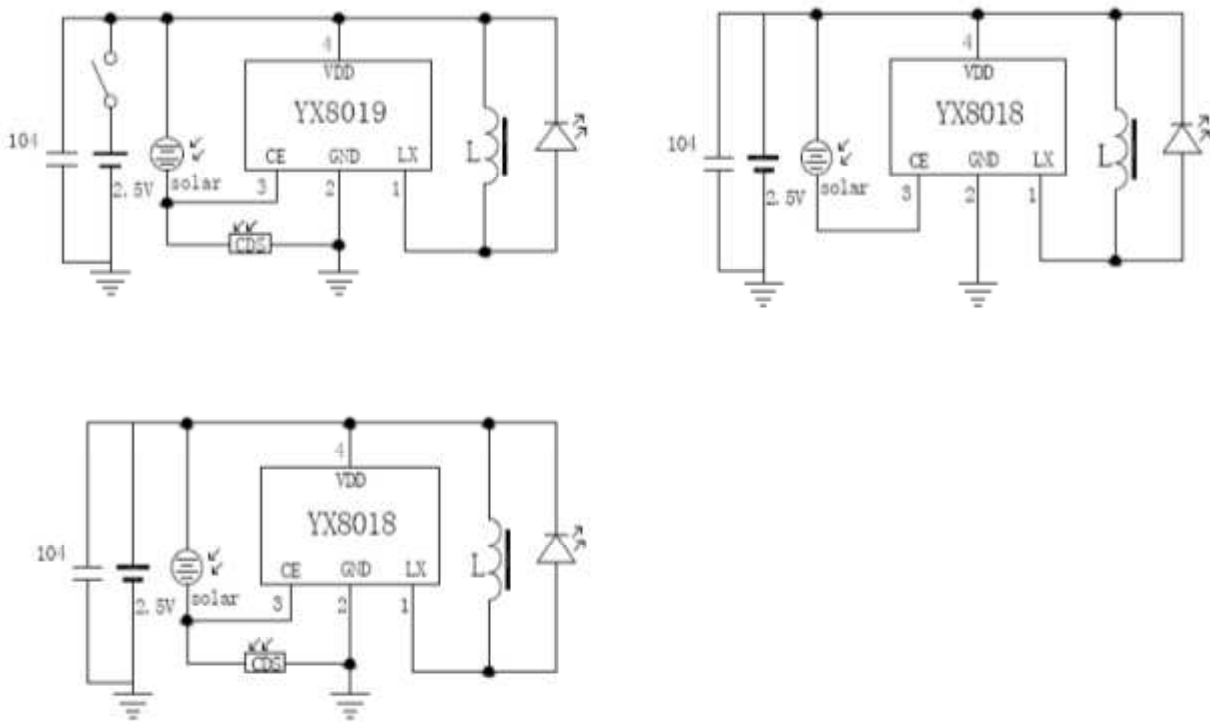

2.5V			
Inductor	package	LED	current
330uH	0307	LEDx1 pieces	3.2mA
220uH	0307	LEDx1 pieces	4.2mA
150uH	0307	LEDx1 pieces	5.4mA
82uH	0307	LEDx1 pieces	10.6mA
68uH	0307	LEDx1 pieces	14.6mA
47uH	0307	LEDx1 pieces	21.4mA
33uH	0307	LEDx1 pieces	29.5mA

Switch connection

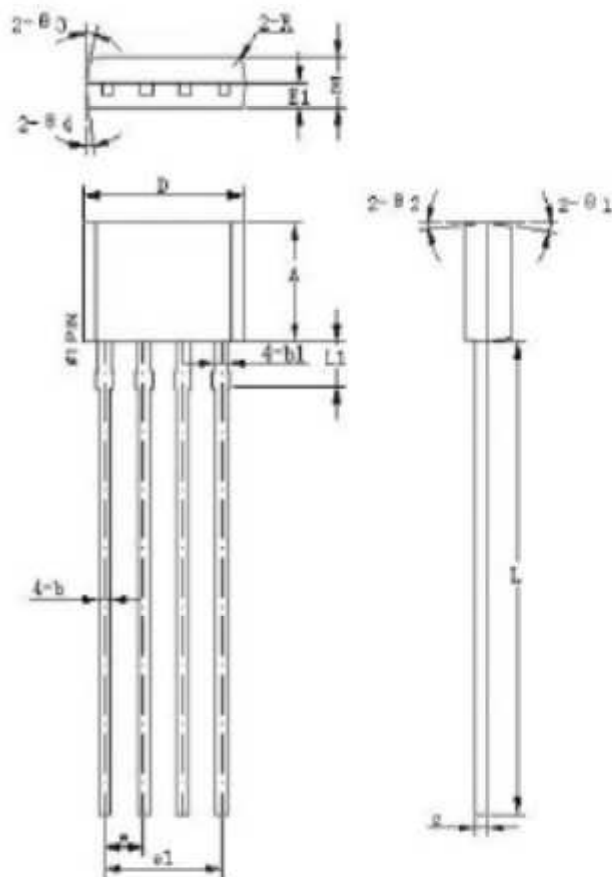
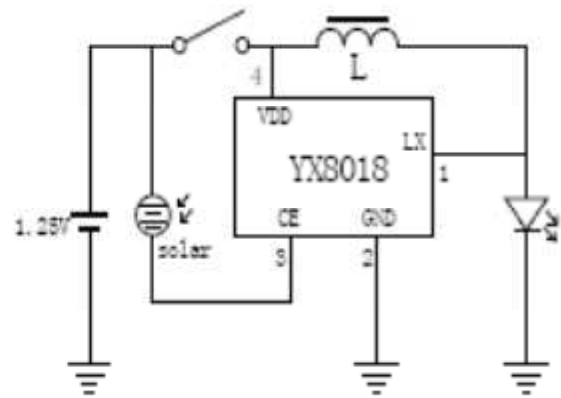
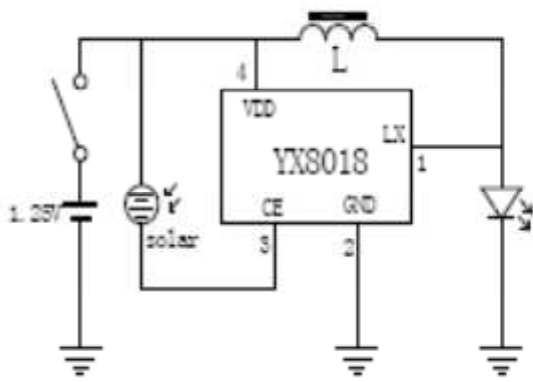

符号	规格尺寸/mm		
	最小值	典型值	最大值
A	3.56	3.66	3.75
b	0.36	0.39	0.68
b1		0.46	
c	0.36	0.38	0.61
D	5.12	5.22	5.32
E	1.46	1.66	1.66
E1		0.76	
e		1.27	
e1		3.81	
L	13.5	14.5	15.5
L1		1.42	
R		0.3	
R1		6°	
R2		4°	
R3		11°	
R4		6°	